

★
T.O. 1F-106A-2-1

TECHNICAL MANUAL
MAINTENANCE

GENERAL AIRPLANE

USAF SERIES

F-106A AND F-106B

AIRCRAFT

GENERAL DYNAMICS/CONVAIR

Contracts AF 33 (600)-36546, AF 41 (608)-12935

CHANGE
NOTICE

LATEST CHANGED PAGES SUPERSEDE
THE SAME PAGES OF PREVIOUS DATE

INSERT CHANGED PAGES INTO BASIC
PUBLICATION. DESTROY SUPERSEDED PAGES.

FOR INSTRUCTIONAL PURPOSES ONLY

PUBLISHED UNDER AUTHORITY OF THE SECRETARY OF THE AIR FORCE

★

T.O. 1F-106A-2-1

Reproduction for nonmilitary use of the information or illustrations contained in this publication is not permitted without specific approval of the issuing service. The policy for use of Classified Publications is established for the Air Force in AFR 205-1.

INSERT LATEST CHANGED PAGES, DESTROY SUPERSEDED PAGES.

LIST OF EFFECTIVE PAGES

NOTE: The portion of the text affected by the changes is indicated by a vertical line in the outer margins of the page.

TOTAL NUMBER OF PAGES IN THIS PUBLICATION IS 164 CONSISTING OF THE FOLLOWING:

<i>Page No.</i>	<i>Issue</i>
*Title	15 Nov 61
*A	15 Nov 61
i thru vii	Original
*viii	15 Nov 61
1-1 thru 1-2	Original
*1-3 thru 1-4	15 Nov 61
1-5 thru 1-17	Original
1-18 Blank	Original
2-1 thru 2-4	Original
*2-5	15 Nov 61
2-6 thru 2-16	Original
3-1 thru 3-9	Original
*3-10	15 Nov 61
3-11 thru 3-15	Original
3-16 Blank	Original
4-1 thru 4-13	Original
4-14 Blank	Original
5-1 thru 5-9	Original
5-10 Blank	Original
6-1	Original
*6-2	15 Nov 61
6-3	Original
*6-4	15 Nov 61
6-5	Original
*6-6 thru 6-8	15 Nov 61
6-9	Original
6-10 Blank	Original
7-1 thru 7-2	Original
*7-2A Added	15 Nov 61
*7-2B Blank	15 Nov 61
*7-3	15 Nov 61
7-4	Original
*7-5	15 Nov 61
7-6 thru 7-8	Original
*7-9	15 Nov 61
7-10 thru 7-14	Original
8-1 thru 8-9	Original
8-10 Blank	Original
9-1 thru 9-11	Original
9-12 Blank	Original
10-1	Original
*10-2 thru 10-5	15 Nov 61
10-6 thru 10-8	Original
11-1 thru 11-6	Original
*11-7 thru 11-8	15 Nov 61
12-1	Original
12-2 Blank	Original
13-1 thru 13-9	Original
13-10 Blank	Original
1 thru 3	Original
4 Blank	Original

*The asterisk indicates pages changed, added, or deleted by the current change.

ADDITIONAL COPIES OF THIS PUBLICATION MAY BE OBTAINED AS FOLLOWS:

USAF ACTIVITIES.—In accordance with T.O. 00-5-2.

E-1

USAF

ALPHABETICAL INDEX

<i>Title</i>	<i>Paragraph</i>	<i>Title</i>	<i>Paragraph</i>	<i>Title</i>	<i>Paragraph</i>
A					
AC Electrical Power Supply Systems, General	11-6	-Electrical Anti-Fog System	7-17	Doors, Fuselage Compartment, General	3-2
AC Emergency Power Supply System	11-7	-Ground Emergency Operation	3-12, 3-18	Drag Chute Release System	4-13
Access and Inspection Provisions	1-12	-Jettison and Seat Ejection	3-11	Drag Chute System, General	8-23
Afterburner, Engine	5-5	-Jettison System	3-10, 3-16	Drainage Provisions, Engine, General	5-19
Afterburner Fuel Control System	5-6	-Seal Pressurization System	4-29	Drive System, Constant Speed Generator, General	5-18
Air Conditioning and Pressurization, Cockpit	7-2	-Seal System	3-6, 7-5		
Air Conditioning and Pressurization, Electronic Compartments	7-6	Center of Gravity Control Transfer System	6-4	E	
Air Conditioning and Pressurization System, General	7-1	Chute, Drag, Release System	4-13	Ejection	
Air Conditioning System	4-22	Cockpit		-Canopy Jettison and Seat	3-11
Airplane Description	1-1	-Air Conditioning and Pressurization	7-2	-Pilot Escape System (Rotational Upward)	3-15
Anti-Fog, Canopy Electrical	7-17	-and Canopy Emergency Seal Pressurization System	7-4	-Pilot Escape System (Upward)	3-9
Anti-Fog System, Windshield Electrical Anti-Ice	7-16	-Low Pressure Warning System	7-3	-Pilot's Seat (Rotational Upward)	3-8
Anti-Ice Systems		-Pressurization System, Emergency	4-10	-Pilot's Seat Upward	3-7
-and Defog Systems, General	7-7	-Red Floodlights	11-18	-Seat, Rotational Upward, Survival Packs	3-20
-and Defog Systems, Hot Air	4-23, 7-10	Combustion Chamber and Turbine Compartment Cooling	5-10	Electrical Systems	
-Artificial-Feel Air Pressure Intake	7-13	Combustion Starter Pneumatic System	4-16	-Armament, Description	13-16
-Engine, General	5-17, 7-11	Compartment Arrangement	1-4	-Canopy Actuating System	3-5
-Engine Inlet Duct Lip	7-12	Console Lights	11-17	-Description	11-1
-Pitot-Static Tube	7-18	Constant Speed Drive Air-Oil Cooler Emergency Valve	4-12	-Power Loading Data	11-2
-Radome	7-14	Constant Speed Drive Oil System Pressurization	4-31	-Power Supply Systems, AC, General	11-6
-Surface and Engine Air	7-8	Constant Speed Generator Drive System, General	5-18	-Power Supply System, AWCIS, General	11-8
-Warning System	7-9	Control Circuit, Normal, Landing Gear, General	9-6	-Power Supply Systems, DC, General	11-3
Anti-Surge Bleed System, General	5-16	Control, Steering	9-17	-Symbols	2-15
Area Dimensions	1-11	Control System, Elevon	8-3	Electronic Compartments Air Conditioning and Pressurization	7-6
Armament Electrical System, Description	13-16	Control System, Flight, Description	8-1	Electronic Systems, General	12-1
Armament Loading, General	13-27	Control System, Rudder	8-4	Elevator Artificial Feel System	4-24
Armament Systems, Description	12-1	Cooling, Engine Accessory Compartment	5-13	Elevator Feel System	8-11
Arrangement, Compartment	1-4	Cooling System, Engine	5-9	Elevon Control System	8-3
Arresting System, Emergency, General	3-21	Cooling System, Engine and Accessory	4-28	Emergency	
Artificial-Feel Air Pressure Intake Anti-Ice System	7-13	Couplings, Quick-Disconnect	2-13	-Arresting System, General	3-21
Artificial Feel System, Elevator	4-24	D			
Artificial Feel System, General	8-9	DC Electrical Power Supply Systems, General	11-3	-CG Fuel Transfer System, F-106A	4-11
Audible Warning System, Landing Gear	9-15	DC Emergency Power Package and Canopy Power Package	11-4	-Cockpit Pressurization System	4-10
Augmentation Lights	11-16	Damper Mode, Pitch	8-17	-Control Circuit, Landing Gear, General	9-9
Automatic Flight Control System, General	8-12	Danger Areas, Engine Air Inlet and Tail Pipe	2-7	-Extend Cycle, Landing Gear	9-10
Automatic Mode, Operation	8-20	Description, Airplane	1-1	-Extension System, Landing Gear	4-19
AWCIS Electrical Power Supply System, General	11-8	Defog and Anti-Icing Systems, General	7-7	-Extension System, Speed Brake	4-14
AWCIS Equipment, General	12-2	Defog System, Pilot's Oxygen Mask	7-19	-Landing Gear Extension System	4-19
B					
Bailout Sequence Warning System, F-106B	3-13	Defueling	6-8	-Operation, Canopy, Ground	3-12, 3-18
Bailout Warning System, F-106B	3-19	Detection Systems, Fire and Overheat, General	11-22	-Power Package and Canopy Power Package, DC	11-4
Bleed System, Anti-Surge, General	5-16	Dimensions		-Power Supply System, AC	11-7
Bolt Threads, Lubrication	2-11	-Area	1-11	-Retraction Cycle, Landing Gear	9-11
Bolt Torque Values	2-8	-Fin	1-9	-Retraction System, Variable Ramp	4-18
Brake System, Main Landing Gear	4-15	-Fuselage	1-10	-Valve, Constant Speed Drive Air-Oil Cooler	4-12
Brake System, Wheel, General	9-19	-General	1-7	Engine	
C					
CG Fuel Transfer System, F-106A, Emergency	4-11	-Wings	1-8	-Accessory Compartment Cooling	5-13
Canopy		Direct Manual Mode, Operations	8-13	-Afterburner	5-5
-and Seat Operating Systems, General	3-4	Directional References, Engine	5-2	-Air Inlet and Tail Pipe	
		Door, Missile Bay and Missile Launching Pneumatic System	4-8	-Danger Areas	2-7
				-and Accessory Cooling System	4-28
				-Anti-Ice System	7-11
				-Anti-Icing System, General	5-17
				-Cooling System	5-9
				-Directional References	5-2
				-Drainage Provisions, General	5-19
				-Inlet Duct Lip Anti-Ice System	7-12
				-Instruments and Warning Systems	5-3

ALPHABETICAL INDEX (CONT)

<i>Title</i>	<i>Paragraph</i>	<i>Title</i>	<i>Paragraph</i>	<i>Title</i>	<i>Paragraph</i>
E		Inlet Duct Variable Ramp Seal Pressurization System 4-30		N	
Engine (Cont)		Inspection Provisions, Access and ...	1-12	Nose Wheel Steering System, General	9-16
-Instruments, General	10-3	Instruments		O	
Equipment Location	1-5	-Engine, General	10-3	Operation	
Extension Cycle, Normal, Landing Gear	9-8	-Flight and Navigation, General ...	10-2	-Automatic Mode	8-20
Extension System, Ram Air Turbine	4-17	-Locations, General	10-1	-Direct Manual Mode	8-13
External Fuel Tank System	6-5	-Panel Lights	11-15	-Pilot Assist Mode	8-19
		-Power Supply System, General	10-5	-Pitch Mode	8-18
				-Yaw Damper Mode	8-15
F		J		Oxygen, Liquid	7-22
Feel System, Artificial	8-9	Jettison System, Canopy	3-16	Oxygen System, General	7-20
Feel System, Artificial, Rudder	4-9			P	
Feel System, Elevator	8-11	K		Personnel Safety	2-6
Feel System, Rudder	8-10	Kit, Survival	3-14	Pilot Assist Mode, Operation	8-19
Fin Dimensions	1-9			Pilot Escape System (Rotational Upward Ejection), General	3-15
Fire and Overheat Detection Systems, General	11-22	L		Pilot Escape System (Upward Ejection), General	3-9
Flight and Navigation Instruments, General	10-2	Landing Gear		Pilot's Anti-G Suit Pressurization System	4-27
Flight Control System, Description ..	8-1	-Audible Warning System	9-15	Pilot's Oxygen Mask Defog System ..	7-19
Floodlights, Cockpit Red	11-18	-Emergency Control Circuit, General	9-9	Pilot's Seat (Rotational Upward Ejection)	3-8
Fuel System		-Emergency Extend Cycle	9-10	Pilot's Seat (Upward Ejection)	3-7
-Control System, Afterburner	5-6	-Emergency Retraction Cycle	9-11	Pitch Damper Mode	8-17
-General	6-1	-Hydraulic System, General	9-3	Pitch "G" Limiter System	8-21
-Main, General	5-4, 6-3	-Normal Control Circuit, General ..	9-6	Pitch Mode, Operation	8-18
-Pressurization System	4-26	-Normal Extension Cycle	9-8	Pitot-Static Tube Anti-Ice System ..	7-18
-Quantity Indication System	6-6, 10-4	-Normal Retraction Cycle	9-7	Pneumatic Sub-Systems, High Pressure, General	4-7
-Tank System, External	6-5	-Pneumatic System	9-5	Pneumatic Sub-Systems, Low Pressure, General	4-21
-Transfer System, CG Control	6-4	-Position Indicating and Warning Systems, General	9-12	Pneumatic Supply System, High Pressure, General	4-3
Fuselage Compartment Doors, General	3-2	-Position Lights	9-13	Pneumatic Supply System, Low Pressure, General	4-20
Fuselage Dimensions	1-10	-System, Description	9-1	Pneumatic System, Combustion Starter	4-16
Fuselage, General	3-1	-Warning Light	9-14	Pneumatic System, Landing Gear, General	9-5
G		Launching System, Missile, Description	13-6	Position Indicating and Warning Systems, Landing Gear, General ..	9-12
General Description		Launching System, Special Weapon, Description	13-14	Position Lights	11-12
-Canopy and Seat Operating Systems	3-4	Lights		Position Lights, Landing Gear	9-13
-Dimensions	1-7	-Augmentation	11-16	Power Distribution, General	11-9
-Fuselage	3-1	-Console	11-17	Power Loading Data, Electrical Systems	11-2
-Ground Handling	2-1	-Instrument Panel	11-15	Power Plant, Description	5-1
-Lubrication	2-3	-Landing	11-13	Power Supply System Instruments, General	10-5
-Principal Dimensions	1-6	-Map Reading	11-20	Pressurization and Air Conditioning System, General	7-1
-Servicing	2-2	-Position	11-12	Pressurization and Venting	6-2
-Special Tools and Ground Support Equipment	2-4	-Systems, General	11-11	Pressurization System	
-Wing	3-3	-Taxi	11-14	-Canopy Seal	4-29
Ground Handling, General	2-1	-Thunderstorm	11-19	-Cockpit and Canopy Emergency- Seal	7-4
H		Limiter System, Pitch "G"	8-21	-Constant Speed Drive Oil	4-31
High Pressure Pneumatic Sub-Systems, General	4-7	Liquid Oxygen	7-22	-Fuel	4-26
High Pressure Pneumatic Supply System, General	4-3	Loading, Armament, General	13-27	-Hydraulic Reservoirs	4-25
Hose and Tubing Maintenance	2-12	Location, Equipment	1-5	-Inlet Duct Variable Ramp Seal	4-30
Hot Air Anti-ice and Defog System	4-23, 7-10	Locations, Station	1-13	-Pilot's Anti-G Suit	4-27
Hydraulic Systems		Low Pressure Pneumatic Sub-Systems, General	4-21	Principal Dimensions, General	1-6
-General	8-5	Low Pressure Pneumatic Supply System, General	4-20	Q	
-Landing Gear, General	9-3	Lubrication, General	2-3	Quick-Disconnect Couplings	2-13
-Power Systems, General	4-1	Lubrication of Bolt Threads	2-11		
-Reservoirs Pressurization System ..	4-25	Lubrication System, General	5-15		
-Sub-Systems, General	4-2				
I		M			
Ignition and Starting Systems, General	5-14	Main Fuel System	6-3		
Indicating System, Fuel Quantity, General	10-4	Main Fuel System, General	5-4		
		Main Landing Gear Brake System ...	4-15		
		Maintenance, Walkways	2-5		
		Map Reading Light	11-20		
		Master Warning System, General ...	11-21		
		Missile Bay Door and Missile Launching Pneumatic System	4-8		
		Missile Launching System, Description	13-6		

ALPHABETICAL INDEX (CONT)

<i>Title</i>	<i>Paragraph</i>	<i>Title</i>	<i>Paragraph</i>	<i>Title</i>	<i>Paragraph</i>
R				W	
Radome Anti-Ice System	7-14	Steering System, Nose Wheel, General	9-16	Walkways Maintenance	2-5
Rainclearing System, Windshield	7-15	Surface and Engine Air Anti-Ice System	7-8	Warning Systems	
Ram Air Turbine Extension System	4-17	Survival Kit	3-14	-Anti-Ice	7-9
Refueling	6-7	Survival Packs (Rotational Upward Ejection Seat)	3-20	-Bailout, F-106B	3-19
Retraction Cycle, Normal, Landing Gear	9-7	Symbols, Electrical	2-15	-Bailout Sequence, F-106B	3-13
Rudder Artificial Feel System	4-9	T		-Cockpit Low Pressure	7-3
Rudder Control System	8-4	Taxi Light	11-14	-Engine Instruments	5-3
Rudder Feel System	8-10	Thunderstorm Lights	11-19	-Landing Gear	9-14
S		Torque Values, Bolt	2-8	-Master	11-21
Safety, Personnel	2-6	Trim Systems, General	8-7	Wheel Brake System, General	9-19
Safety Wiring	2-14	Tubing and Hose Maintenance	2-12	Windshield Electrical Anti-Ice, Anti-Fog System	7-16
Seal System, Canopy	3-6, 7-5	Tubing Compartment and Com- bustion Chamber, Cooling	5-10	Windshield Rainclearing System	7-15
Servicing, General	2-2	Turn Coordination	8-16	Wings, Dimensions	1-8
Special Tools and Ground Support Equipment, General	2-4	U		Wing, General	3-3
Special Weapon Launching System, Description	13-14	V		Wiring, Safety	2-14
Speed Brake Emergency Extension System	4-14	Variable Ramp Emergency Retraction System	4-18	X	
Speed Brake System, General	8-22	Variable Ramp System	5-7	Y	
Starting and Ignition Systems, General	5-14	Venting and Pressurization	6-2	Yaw Damper Mode	8-14
Station Locations	1-13	Z		Yaw Damper Mode, Operation	8-15
Steering Control	9-17				

GENERAL AIRPLANE
 MANUAL
 T.O. 1F-106A-2-1

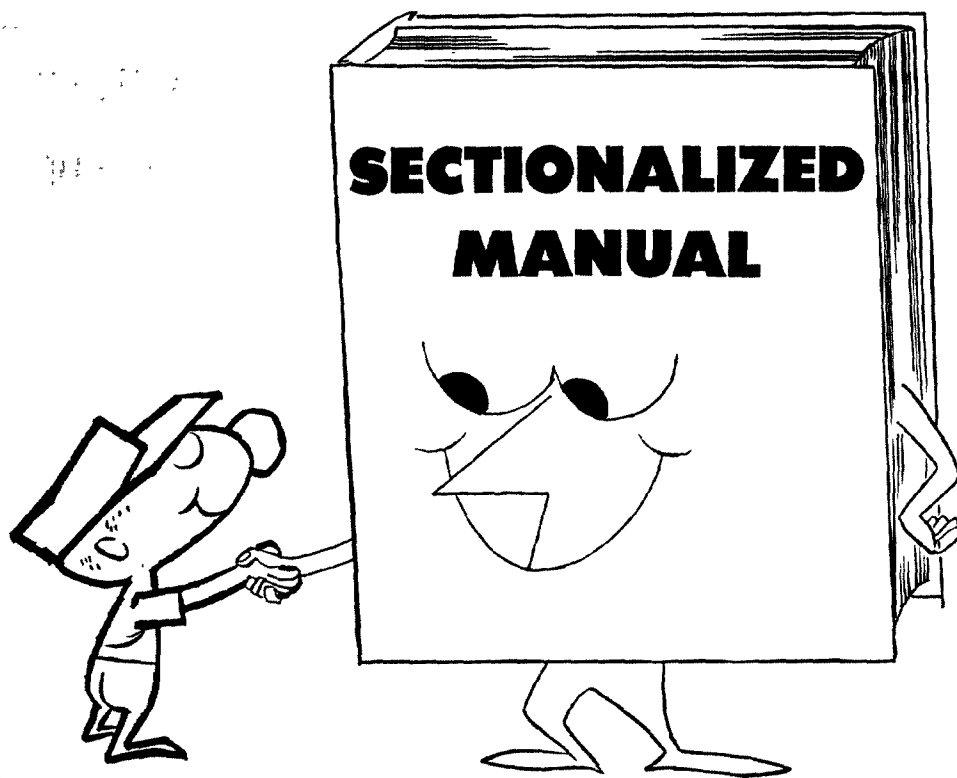

GENERAL AIRPLANE MANUAL

General Airplane Manual T.O. 1F-106A-2-1 provides you with a factual overall description of the F-106A airplanes 56-453, -454, 56-456 and subsequent, and F-106B airplanes 57-2508 and subsequent—it will reference you to the other manuals of this series for detailed descriptions and specific maintenance instructions. This book can give you, in capsule form, a general knowledge of the airplane's systems and their interrelationship.

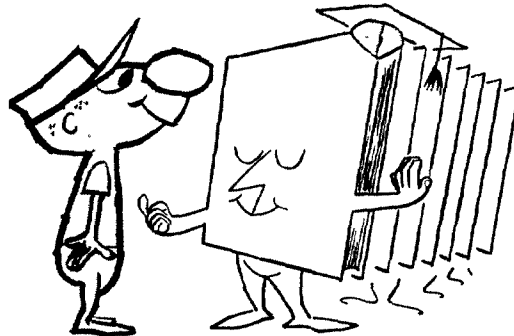

SYSTEMS MAINTENANCE MANUALS

The F-106A and F-106B Systems Maintenance Manuals have been prepared in a series of manuals, each designed to fit the needs of a system mechanic or maintenance technician. Each manual contains the information necessary for the systems mechanic to understand and maintain his particular systems and components. Reference to other manuals of the series will be necessary only when a maintenance problem involves systems within the scope of another system technician.

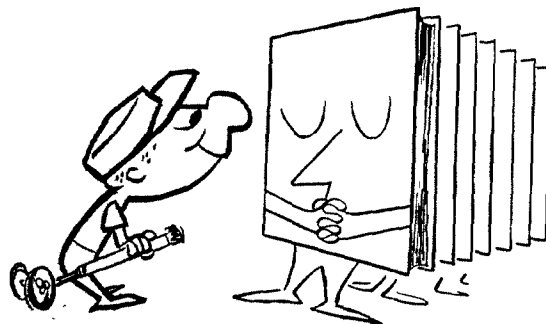

IDENTIFY YOUR AIRPLANE

The information contained in these manuals is applicable to the F-106A and F-106B airplanes. When the information on a particular system, component or procedure is peculiar to a certain model or series, applicability to that model and the airplanes affected is specified.

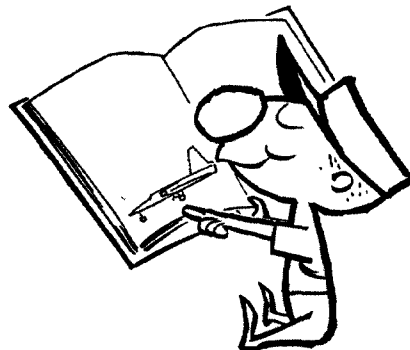

SYSTEM MAINTENANCE

It is intended that each systems mechanic have a copy of his manual readily available. Revisions will be made and distributed as new equipment is installed in the airplane and as new or improved procedures are discovered. The systems mechanic should check the Technical Order Index regularly to see that the latest revisions are included in his copy.

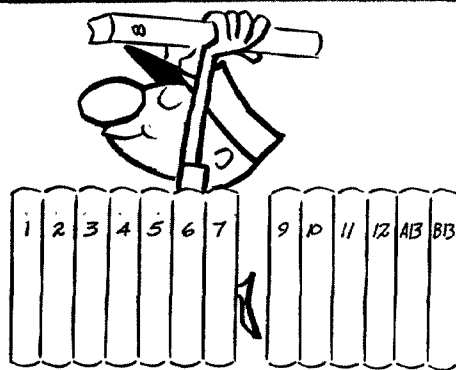

USING LIMITATIONS

1. Select the correct manual —The systems covered are usually evident by the manual title.
2. Turn to desired Section—if Section title does not limit section to a particular model series, the Section pertains to all models covered in Manual.
3. Find desired paragraph heading—if paragraph heading does not contain a limitation, paragraph is limited to same models as entire section. NOTE: Sometimes parts of paragraphs are limited.



IN RECOGNITION of the systems mechanic's need, information in these manuals includes system testing and trouble shooting methods, as well as detailed maintenance procedures. The sections of each manual are divided into the following main subsections, as applicable: Description, Operational Checkout, System Analysis, Replacement, Adjustment, Servicing and Maintenance.

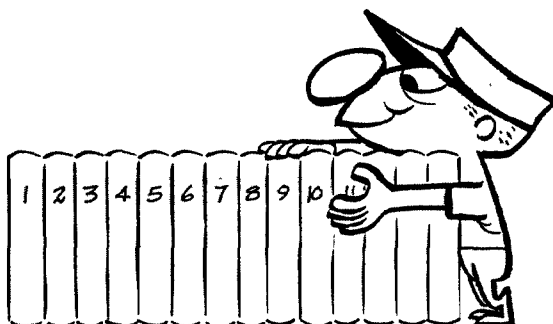

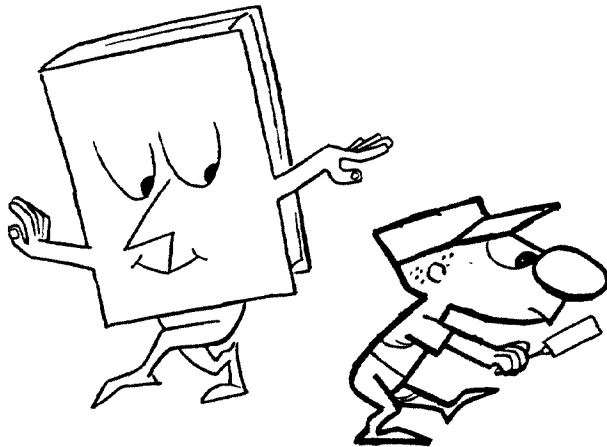

HOW TO FIND INFORMATION

THE TABLE OF CONTENTS

If a general reference to a complete system is desired, use the Table of Contents given on page "i" of this manual. The Table of Contents consists of a list of section titles and the page number on which that section begins.

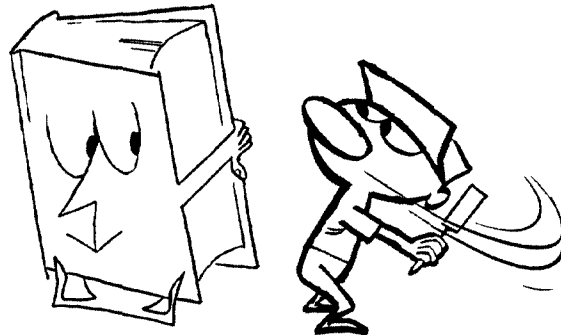

THE INTRODUCTION

This is the section of the manual in which you find yourself at this moment. As you found this gives the reason for sectionalized manuals, what information you will find in them, and how they are arranged.

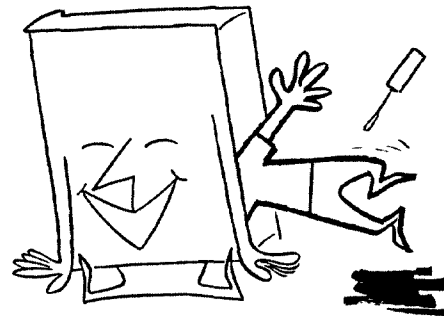

THE SECTION TABLE OF CONTENTS

At the beginning of each section a list of subsection titles is given to indicate the location of information in that section. System titles, are carried at the top of each page for further aid in locating information.

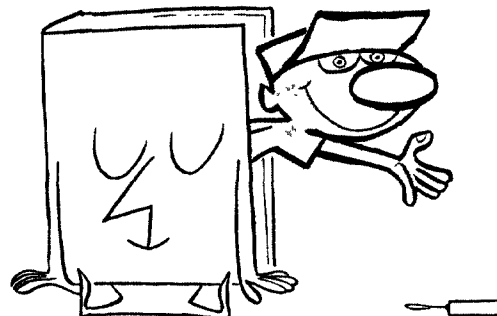

THE ALPHABETICAL INDEX

If a reference to a detail, such as a particular component or procedure, is required, then the Alphabetical Index located at the back of the book should be used. The Alphabetical Index locates information on systems or components.

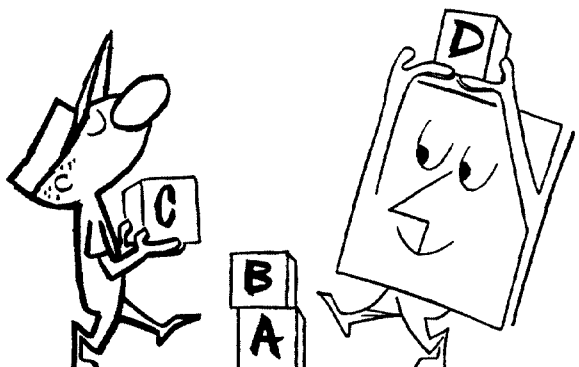

IF REFERENCE to a complete system is desired, use the TABLE OF CONTENTS. If on the other hand you are looking for specific maintenance data on a particular item, or wish to find out why a certain unit is in the system and what it does, turn to the ALPHABETICAL INDEX and locate the system or unit by name.

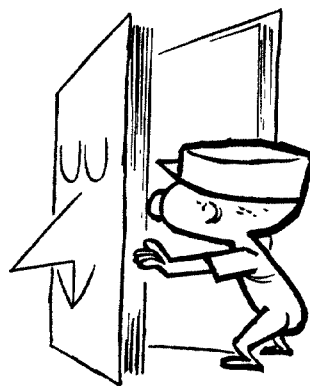

SUPPLEMENTARY INFORMATION

Supplementary information on operation, repair, inspection, parts listing, and weight and balance may be found in the publications listed on one of the pages following.



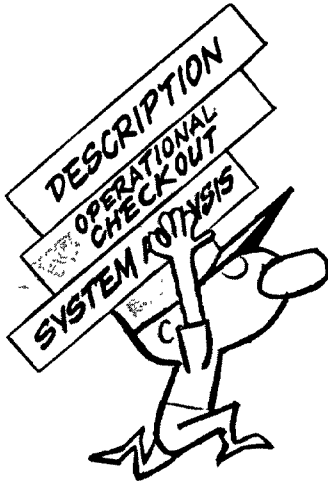

ARRANGEMENT OF YOUR SECTIONALIZED MANUAL

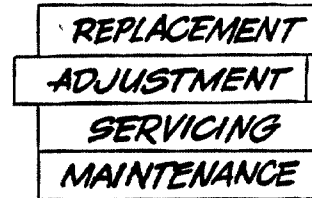

DESCRIPTION

This subsection contains an overall description of the complete system and includes the various normal and emergency function and description of each of the components in that system. The flow diagrams and schematics necessary for complete understanding of the systems, as well as the interconnections between other systems, are also provided in this section.

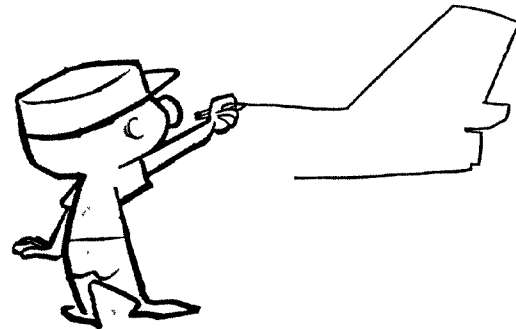

OPERATIONAL CHECKOUT

This subsection contains the step-by-step checkout of the system and components to assure that minimum requirements for the proper operation of the system are met.



SYSTEM ANALYSIS

Contained under this heading is a list of troubles which could develop within the system or in one of its components. The trouble shooting chart lists the possible cause of the malfunction, indicates the isolation procedure to direct the mechanic as easily as possible to the trouble area, and prescribes the remedial maintenance action.



REPLACEMENT

This subsection contains detailed step-by-step procedures for removal and installation of system components.

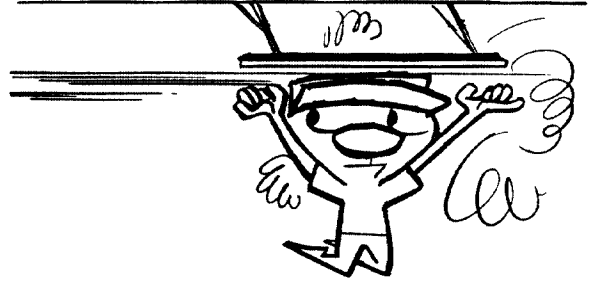
**ADJUSTMENT**

This subsection includes detailed step-by-step procedures for the adjustment of the complete system and the system components.

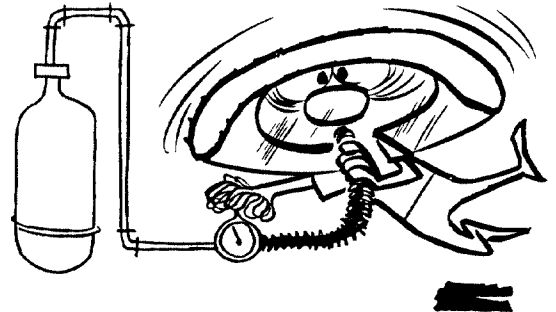
**SERVICING**

This subsection includes instructions for cleaning, draining, replenishing, and lubricating the system and components.

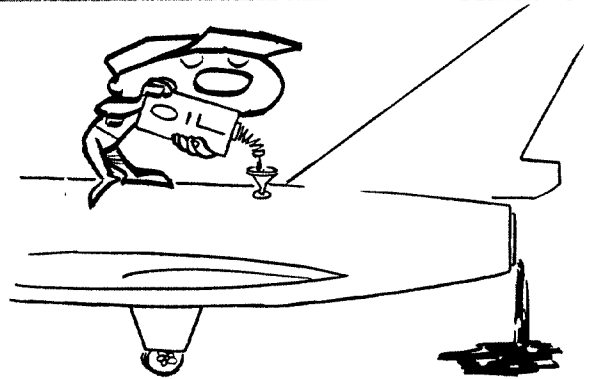
**MAINTENANCE**

This subsection contains information and procedures of a special nature which will be of value when performing repairs beyond the scope of Replacement and Servicing.

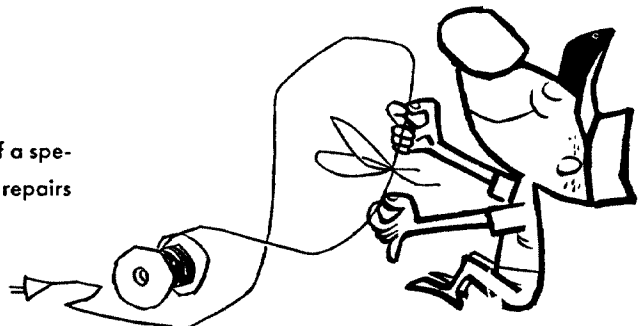

LIST OF F-106A AND F-106B SYSTEMS MAINTENANCE MANUALS

- | | | | |
|-------------------|--|-------------------|--|
| T.O. 1F-106A-2-1 | General Airplane | T.O. 1F-106A-2-15 | Aircraft and Weapon Control Interceptor Systems, Type MA-1 and Type AN/ASQ-25, Dock Instructions |
| T.O. 1F-106A-2-2 | Ground Handling, Servicing, And Airframe Group Maintenance | T.O. 1F-106A-2-24 | Aircraft and Weapon Control Interceptor System, Type MA-1, Wiring Data (F-106A); Serial Nos. 57-246, 57-2453 thru 57-2464, 57-2466 thru 57-2506. |
| T.O. 1F-106A-2-3 | Hydraulic and Pneumatic Power Systems | T.O. 1F-106B-2-24 | Aircraft and Weapon Control Interceptor System, Type AN/ASQ-25, Wiring Data (F-106B); Serial Nos. 57-2516 thru 57-2522, 57-2524 thru 57-2531. |
| T.O. 1F-106A-2-4 | Power Plant | T.O. 1F-106A-2-25 | Aircraft and Weapon Control Interceptor System, Type MA-1, Wiring Data (F-106A); Serial Nos. 56-453, 56-454, 56-456 thru 56-467, 57-230 thru 57-238, 57-240 thru 57-245, 57-2465, 58-759 and subsequent. |
| T.O. 1F-106A-2-5 | Fuel Supply System | T.O. 1F-106B-2-25 | Aircraft and Weapon Control Interceptor System, Type AN/ASQ-25, Wiring Data (F-106B); Serial Nos. 57-2508 thru 57-2515, 57-2523, 57-2532 and subsequent. |
| T.O. 1F-106A-2-6 | Air Conditioning, Anti-Icing, And Oxygen Systems | T.O. 1F-106A-2-27 | MA-1 AWCIS Pocketbook |
| T.O. 1F-106A-2-7 | Flight Control Systems | Vol. I | Flight Line Instructions |
| T.O. 1F-106A-2-8 | Landing Gear | Vol. II | Dock Instructions for Power, Radar and AAI Subsystems |
| T.O. 1F-106A-2-9 | Instrument Systems | Vol. III | Dock Instructions for FC&M, Computer, CN&L Subsystems |
| T.O. 1F-106A-2-10 | Electrical Systems | | |
| T.O. 1F-106A-2-12 | Armament Systems | | |
| T.O. 1F-106A-2-13 | Wiring Diagrams, Airframe (F-106A) | | |
| T.O. 1F-106B-2-13 | Wiring Diagrams, Airframe (F-106B) | | |

SUPPLEMENTARY DATA

- | | | | |
|---------------------|--|------------------------|--|
| T.O. 1F-106A-01 | List of Applicable Publications | T.O. 1F-106A-10 | Power Package Buildup Instructions |
| T.O. 1F-106A-1 | Flight Manual | T.O. 1F-106A-16-1 | Weapon Loading Procedures |
| T.O. 1F-106B-1 | Flight Manual | T.O. 1F-106A-16-2 | Job-Oriented Weapon Loading Procedures |
| T.O. 1F-106A-CL-1-1 | Pilot's Checklist | T.O. 1F-106A-CL-16-1-1 | Supervisory Control Sheet |
| T.O. 1F-106B-CL-1-1 | Pilot's Checklist | T.O. 1F-106A-CL-16-1-2 | Loading Crew Chief's Abbreviated Checklist |
| T.O. 1F-106A-3 | Structural Repair Manual | T.O. 1F-106A-17 | Storage of Aircraft |
| T.O. 1F-106A-4 | Illustrated Parts Breakdown | T.O. 1F-106A-18 | Field Maintenance of Airborne Material |
| T.O. 1F-106B-4 | Illustrated Parts Breakdown | T.O. 1F-106A-20 | Product Improvement Digest |
| T.O. 1F-106A-5 | Basic Weight Checklist and Loading Data | T.O. 1F-106A-21 | Master Guide Aircraft Inventory Record |
| T.O. 1F-106B-5 | Basic Weight Checklist and Loading Data | T.O. 1F-106A-29 | Aircrew Weapon Delivery |
| T.O. 1F-106A-6 | Aircraft Scheduled Inspection and Maintenance Requirements | T.O. 1F-106A-CL-29-1 | Aircrew Weapon Delivery Procedures Checklist |

Section I

AIRPLANE

<i>Contents</i>	<i>Page</i>
General Information	1-1
Principal Dimensions	1-5
Access and Inspection Provisions	1-7

GENERAL INFORMATION

1-1. DESCRIPTION.

The F-106A and F-106B airplanes, manufactured by Convair, a Division of General Dynamics Corporation, are high-speed, delta-wing interceptors. The airplanes are powered by the Pratt and Whitney J-75 engine with afterburner, and are designed for high-altitude, all-weather operations. The F-106B airplane is a two-place, tandem version of the single-place F-106A airplane.

1-2. Identifying characteristics of the airplanes, as illustrated on figure 1-1, are the thin, 60° delta wings with cambered leading edges; the swept-back vertical stabilizer; the extended nose section forward of the canopy, with its airspeed boom; and the integration of canopy and fuselage lines. The airplanes incorporate a retractable tricycle landing gear, widely spaced for ground stability. Flight controls consist of elevons and a conventional-type rudder. The elevons perform the function of elevators and ailerons through conventional movements of the control stick.

1-3. Special features incorporated in the airplanes include the following:

- a. Thermal anti-icing of the engine air intake ducts lips and engine guide vanes.
- b. Adhesive-sealed, integral fuel tanks.
- c. Single-point refueling and defueling provisions.
- d. Speed brakes and drag chute for additional control.
- e. Air conditioning and pressurization of the cockpit and electronics compartments.
- f. Canopy jettisoning and seat ejection.

g. Two separate, continuously operating hydraulic systems, either of which is capable of providing hydraulic power to operate the flight control system.

h. High pressure pneumatic system to operate certain equipment, and to provide an emergency means of extending the landing gear and speed brakes.

i. An armament system for carrying missiles and a special weapon.

j. Easy access to radar and electronics equipment.

k. Radar or optical sighting for armament.

l. Jettisonable external fuel tanks.

m. Manual, Damper, Pilot Assist, and Automatic modes of flight control.

n. Emergency Arresting System for stopping airplane if normal devices fail.

1-4. COMPARTMENT ARRANGEMENT.

The interiors of the F-106A and F-106B airplanes are arranged into compartments as shown on figures 1-2 and 1-3. The compartments accommodate the pilot(s), the electrical and electronic equipment, armament equipment, pressurization equipment, the engine, and the engine accessories. In general, the compartments are arranged as follows:

a. The nose section, consisting of the radome, and of the left and right forward electronics compartments, houses antennas and electronic equipment.

b. The pressurized cockpit is equipped with a jettisonable canopy, and accommodates the ejection seat(s), the controls, instruments, and other equipment.

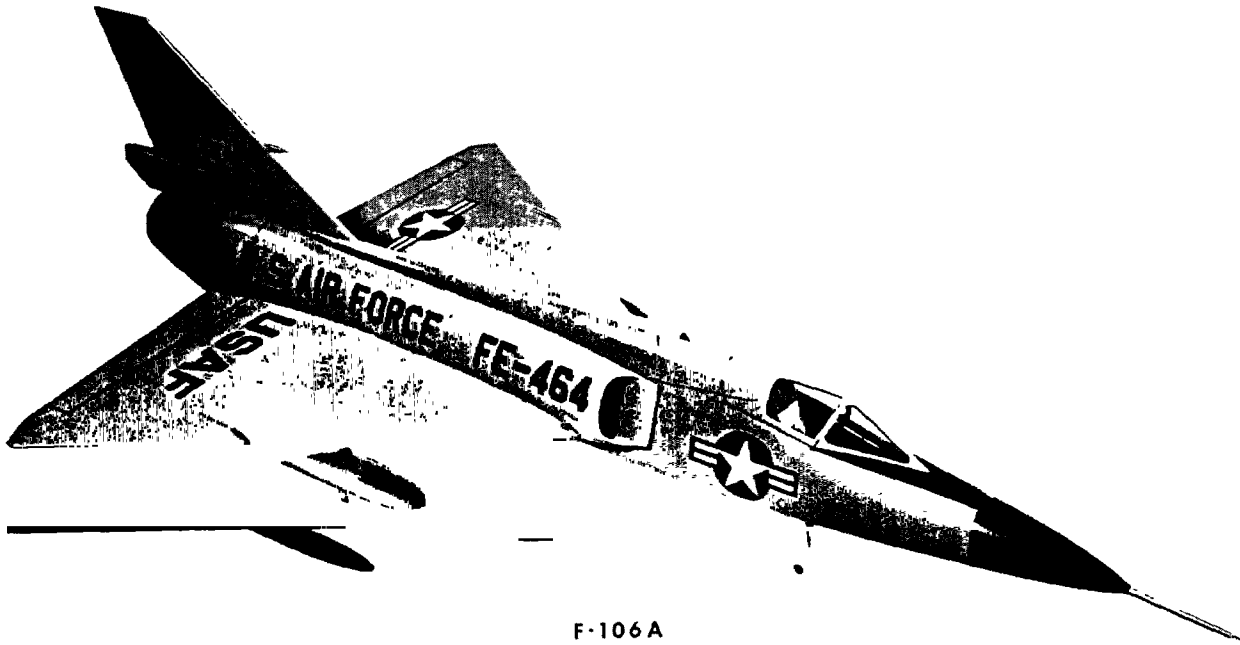

F-106A



F-106B

06 02 436A 05 01 00

Figure 1-1. F-106A and F-106B Airplanes

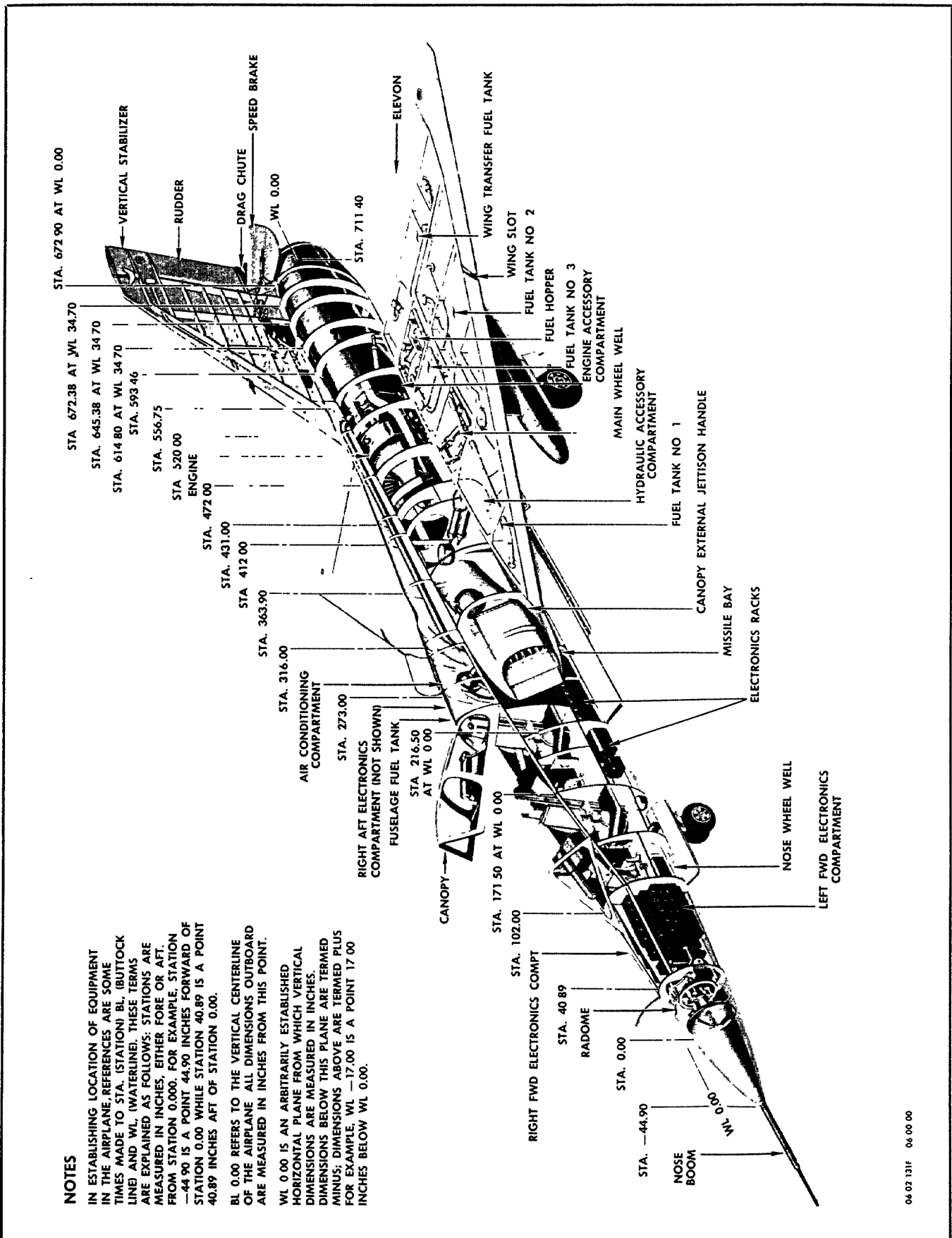

Figure 1-3. Airplane Stations and Compartments, F-106B

c. The nose wheel well directly below the cockpit houses the nose landing gear in the retracted position and also contains electrical and electronic components.

d. The upper and lower aft electronics compartments, located directly behind the cockpit, house various items of electrical and electronic equipment.

e. A fuselage fuel tank is located aft of the cockpit and above the forward portion of the missile bay. On most airplanes, this tank contains usable fuel for engine consumption. On some *F-106A airplanes*, the fuel in this tank, in conjunction with wing transfer tanks, is also used to control the airplane's center of gravity for specific flight conditions.

f. The air conditioning compartment in the top of the fuselage accommodates pressurization and air conditioning equipment.

g. The missile bay in the bottom of the fuselage houses the aircraft armament.

h. The engine compartment houses the turbojet engine and its related equipment and components of various systems.

i. The hydraulic accessories compartment houses the hydraulic storage components, ground servicing connections and the emergency hydraulic components of the hydraulic systems.

j. The main wheel wells house the main landing gear in the retracted position and the components of various systems.

k. The tail cone section houses the afterburner. The drag chute is contained in a drag chute canister directly above the tail cone. When retracted, the speed brakes close the drag chute opening in the fuselage.

1-5. EQUIPMENT LOCATION.

To establish equipment location in the airplane, references are sometimes made to sta. (station), BL (buttock line) and WL (waterline). These terms are explained as follows: stations are measured in inches, either fore or aft from station 0.00. For example, station -44.90 is a point 44.90 inches forward of station 0.00 while station 40.89 is a point 40.89 inches aft of station 0.00. BL 0.00 refers to the vertical centerline of the airplane. All dimensions outboard are measured in inches from this point. WL 0.00 is an arbitrarily established horizontal plane from which vertical dimensions are measured in inches. Dimensions below this plane are termed minus; dimensions above are termed plus. For example, WL -17.00 is a point 17.00 inches below WL 0.00. See figures 1-2 and 1-3 for airplane stations.

PRINCIPAL DIMENSIONS

1-6. GENERAL.

The length, span, height, and other principal dimensions of the F-106A and F-106B airplanes are tabulated in paragraphs 1-7 thru 1-11. Figure 1-4 illustrates the principal dimensions of each airplane type. The height dimension will vary with the airplane weight, and with tire and landing gear inflations. These conditions must always be considered when moving the airplane in areas where vertical tolerances are small. The turning radii of the F-106A and F-106B airplanes are shown on figure 1-5.

1-7. GENERAL DIMENSIONS.

Span	38 ft 3.5 in
Length (maximum, including air speed boom)	70 ft 8.78 in
Tread of main wheels	15 ft 5.54 in
Height (over vertical fin)	20 ft 3.3 in

1-8. WINGS.

Designation	NACA 0004-65 (Mod)
Thickness (percent chord)	4
Chord (at root)	35 ft 7.6 in
Mean aerodynamic chord	23 ft 9.1 in
Incidence	0 degrees

Dihedral	0 degrees
Sweepback at leading edge	60 degrees
Aspect ratio	2.198

1-9. FIN.

Designation	NACA 0004-65 (Mod)
Thickness (percent chord)	4
Sweepback of leading edge	55 degrees
Height, from static ground line (strut inflation normal)	20 ft 3.3 in

1-10. FUSELAGE.

Width (maximum)	8 ft 1.0 in
Height (maximum, without fin)	6 ft 6.8 in
Length, maximum (including air speed boom)	70 ft 8.78 in

1-11. AREA DIMENSIONS.

Wings (including elevons)	697.83 sq ft
Wings (without elevons)	631.23 sq ft
Elevons (aft of hinge line)	66.60 sq ft
Fin (including rudder)	93.90 sq ft
Fin (without rudder)	82.80 sq ft
Rudder (aft of hinge line)	11.10 sq ft

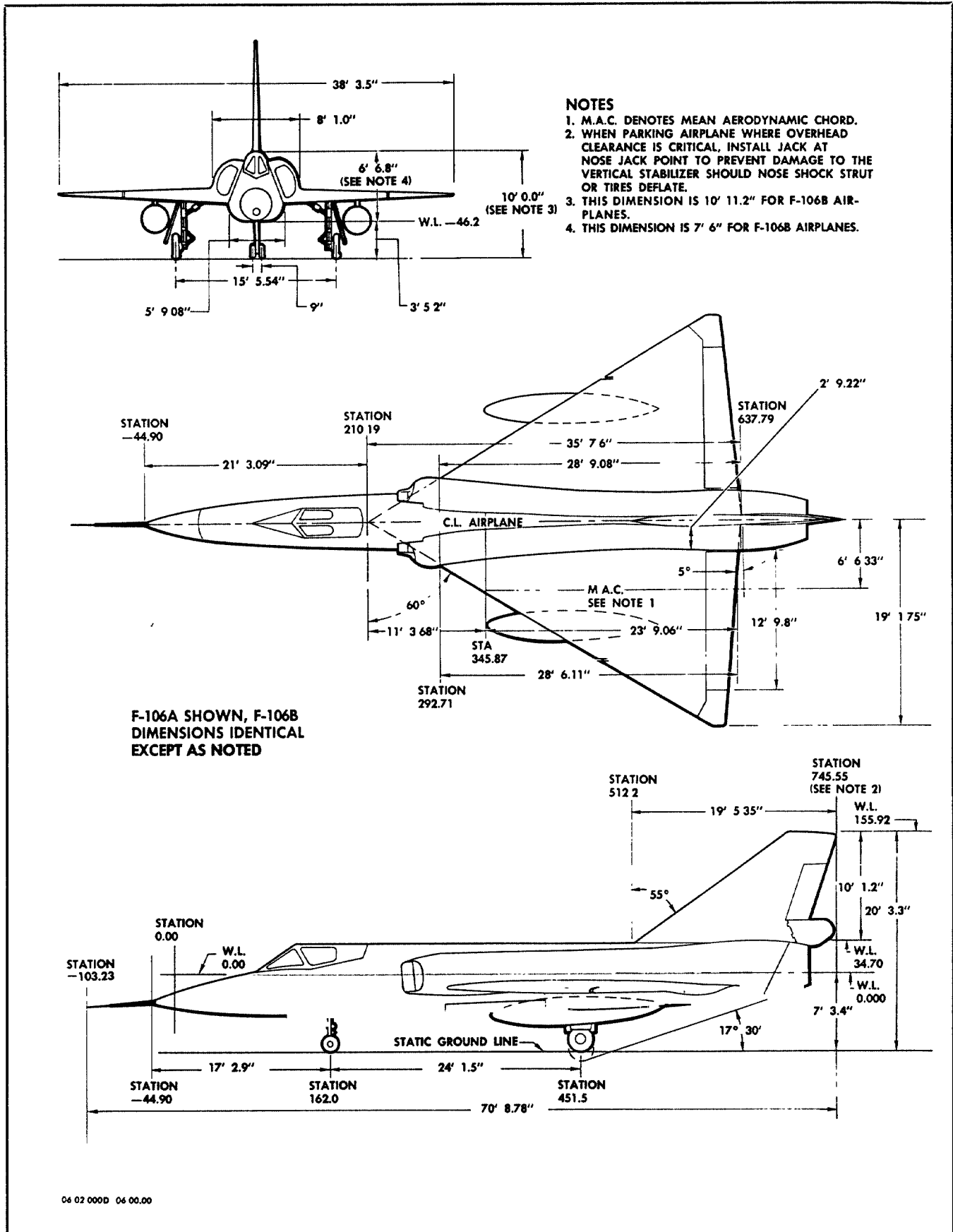

Figure 1-4. Airplane Principal Dimensions

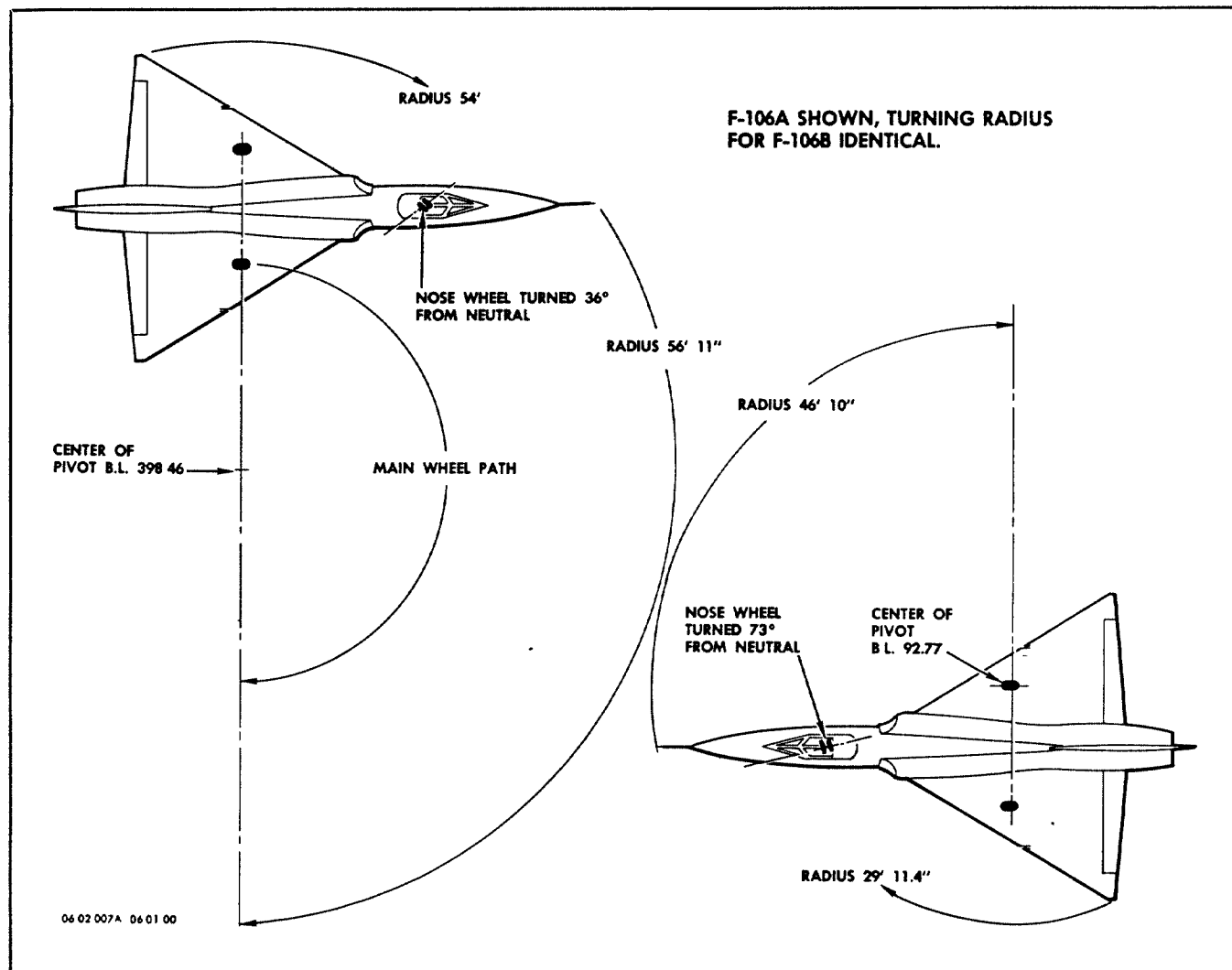

Figure 1-5. Turning Radii

ACCESS AND INSPECTION PROVISIONS

1-12. ACCESS AND INSPECTION PROVISIONS.

Access and inspection doors are provided throughout the airplane, as shown on figures 1-6 thru 1-11. Information as to the equipment that can be reached through any door, and the type of door, can be obtained from the key list for the illustration. A number is stenciled on most doors, with a corresponding number stenciled on the airplane structure beside the door opening. These numbers are provided to insure that the doors are positioned and installed correctly. When installing access doors, these numbers must be aligned to insure that the

door is in proper contour with the airplane structure and that the predetermined clearance between the outside edge of door and airplane structure is maintained. Information concerning the sealing of certain doors during installation is contained in T.O. 1F-106A-2-2. Other equipment can be reached through the open wheel wells, and by removing the engine, radome, and tail cone.

1-13. STATION LOCATIONS.

The location of the major stations of the F-106A and F-106B airplanes are shown on figures 1-12 and 1-13.

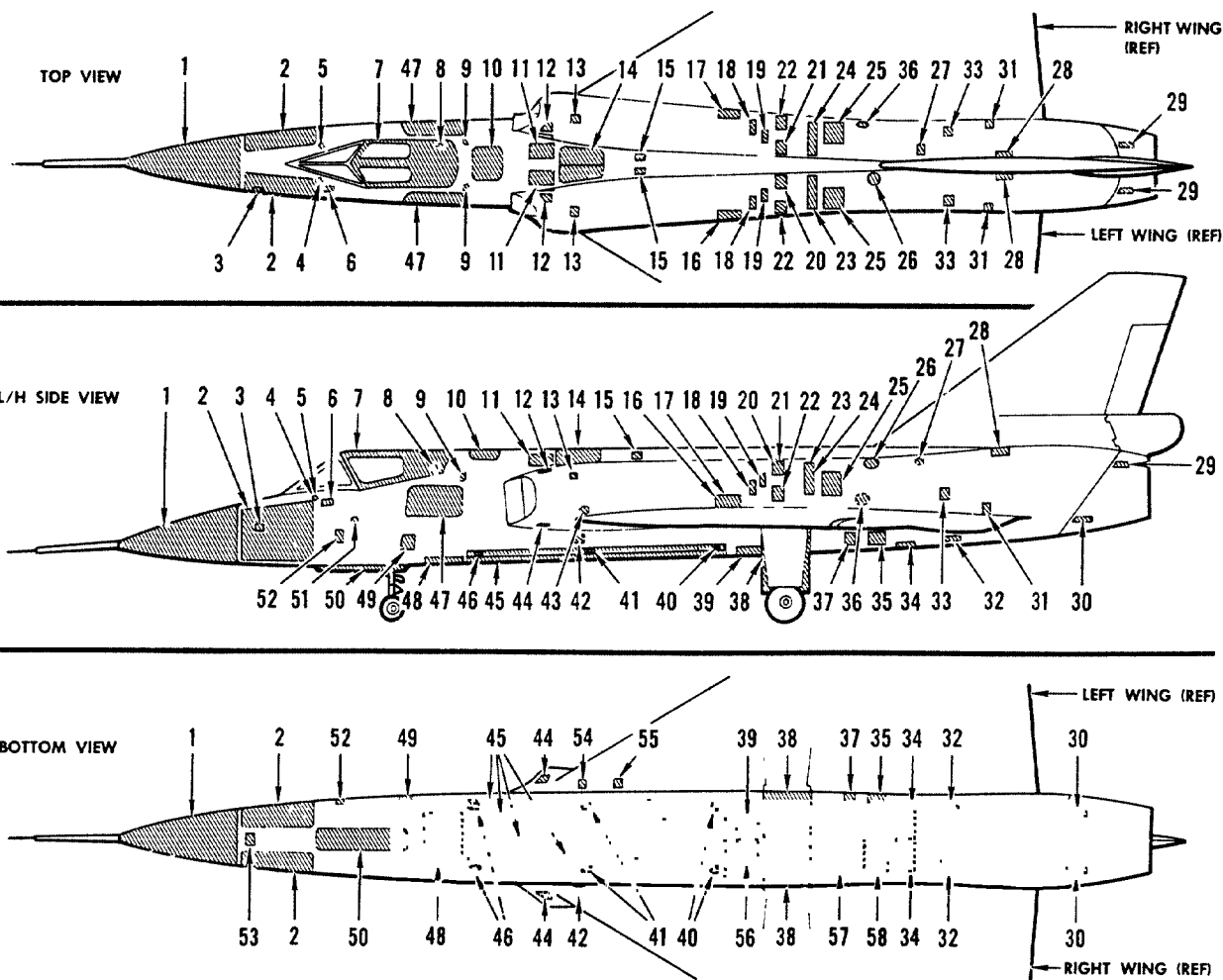

ACCESSIBLE EQUIPMENT

1. RADAR ANTENNA.
2. FORWARD ELECTRONIC EQUIPMENT.
3. (703) ANGLE OF ATTACK TRANSDUCER
4. BRAKE SYSTEM COMPONENTS.
5. (227) CANOPY LATCH MECHANISM. WINDSHIELD ANTI-ICE TRANSFORMER.
6. CANOPY CONTROLS, EXTERNAL
7. COCKPIT FURNISHINGS.
8. (229) CANOPY ACTUATOR.
9. (761), (762) STRUCTURE ACCESS.
10. (231) FUEL TANK PROBE. FUEL VALVES
11. (239), (240) FUEL LINES.
12. (741), (742) DUCT LIP ANTI-ICING LINES, UPPER.
13. (763), (764) VARIABLE RAMP PITOT-STATIC COMPONENTS.
14. (937) AIR CONDITIONING COMPONENTS. ANTI-ICING TANK. HIGH-PRESSURE PNEUMATIC FLASKS. VARIABLE RAMP ACTUATOR GIMBALS.
15. (765), (766) RUDDER CABLE PULLEY.
16. (779) MA-1 POWER TRANSFER RELAY BOX (SEE NOTE 2).

17. (736) PITCH AND YAW DAMPER AMPLIFIER
18. (283), (284) STRUCTURE ACCESS.
19. (285), (287) STRUCTURE ACCESS.
20. (281) TUBING OIL COOLING DUCT VALVE BEARING.
21. (273) DUCT VALVE BEARING.
22. (271), (279) OIL COOLING AIR CONTROL
23. (277) ENGINE AIR-OIL COOLER.
24. (275) GENERATOR OIL COOLER.
25. (297), (298) ENGINE MOUNT, FORWARD.
26. (305) ENGINE OIL TANK FILLER CAP.
27. (315) BLEED MANIFOLD.
28. (325), (326) ENGINE MOUNT, AFT
29. (333), (334) TAIL CONE LATCH, UPPER.
30. (335), (336) TAIL CONE LATCH, LOWER.
31. (319), (320) ELEVON ACTUATOR, AFT END.
32. (321), (322) ELEVON VALVE.
33. (323), (324) ELEVON ACTUATOR, FORWARD END.
34. ENGINE, AFT SECTION.
35. (303) HYDRAULIC PUMP.
36. CONSTANT SPEED SYSTEM OIL FILLER CAP
37. FIRE ACCESS DOOR.
38. MAIN LANDING GEAR WHEEL WELL.
39. RAM AIR TURBINE.

40. (753), (754) MISSILE BAY DOOR MECHANISM, AFT.
41. (751), (752) MISSILE BAY DOOR MECHANISM, MID.
42. REFUELING FITTING.
43. CANOPY EXTERNAL JETTISON HANDLE
44. (743), (744) DUCT LIP ANTI-ICING, LOWER
45. MISSILE BAY.
46. (749), (750) MISSILE BAY DOOR MECHANISM, FORWARD
47. (209), (210) UPPER AFT ELECTRONIC EQUIPMENT.
48. LOWER AFT ELECTRONIC EQUIPMENT.
49. EXTERNAL POWER RECEPTACLE.
50. NOSE LANDING GEAR WHEEL WELL
51. (759) CONTROL STICK TORQUE TUBE.
52. OXYGEN SERVICING CONNECTION
53. (215) SHOCK MOUNT.
54. (755) COCKPIT-ELECTRONIC COMPARTMENT GROUND CONDITIONING CONNECTION.
55. (753) MISSILE BAY GROUND CONDITIONING CONNECTION.
56. HYDRAULIC SYSTEM COMPONENTS.
57. CONSTANT SPEED REMOTE GEARBOX.
58. ENGINE ACCESSORIES.

NOTES

1. NUMBERS IN PARENTHESES ARE NUMBERS STENCILED ON DOORS. ON ITEMS HAVING 2 PARENTHEZIZED NUMBERS, THE FIRST NUMBER APPLIES TO THE LEFT SIDE OF THE AIRPLANE AND THE SECOND NUMBER APPLIES TO THE RIGHT SIDE.

2. APPLICABLE TO 56-453, -454, 56-456 THRU 57-245, -2453, 57-2465, 58-759 AND SUBSEQUENT; AND 57-246, -2454 THRU -2464, -2466 THRU 57-2506 AFTER INCORPORATION OF TCTO 1F-106-609.

Figure 1-6. Access and Inspection Provisions, F-106A, Fuselage

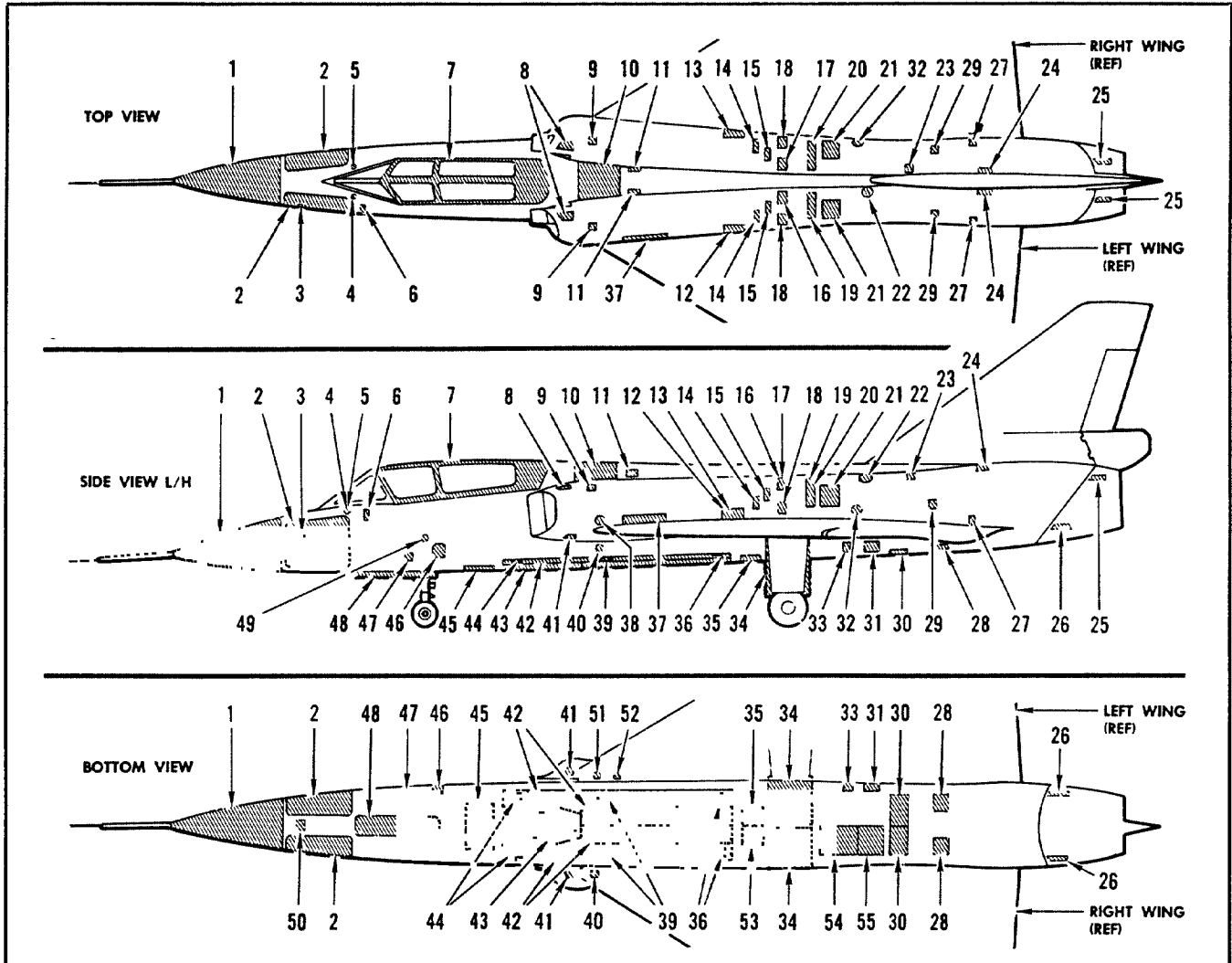

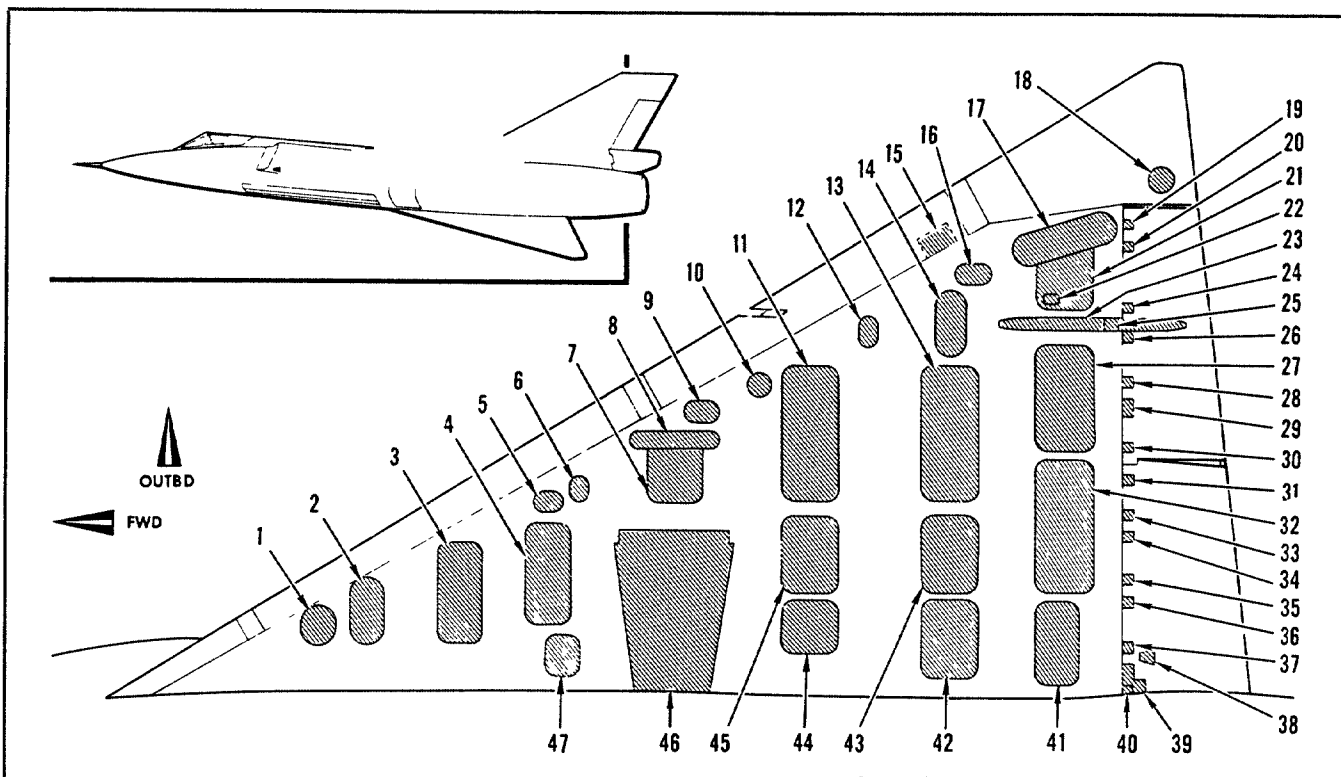

ACCESSIBLE EQUIPMENT

- | | |
|---|--|
| <p>1 (1), (2) FUEL SYSTEM TANK 1 F-106A, PRESSURE RELIEF VALVE. F-106B, REFUEL PILOT VALVE.</p> <p>2 (3), (4) FUEL SYSTEM TANK 1 C. G. TRANSFER LINE</p> <p>3 (5), (6) FUEL SYSTEM TANK 1 REFUEL SHUTOFF VALVES. REFUEL PILOT VALVES. VENT AND PRESSURE RELIEF VALVES. F-106A, C. G. TRANSFER LINES, AIR OPERATED SHUTOFF VALVES, REFUEL PRESSURE OPERATED VALVES. F-106B, TRANSFER LINE</p> <p>4 (9), (10) FUEL SYSTEM TANK 1. TANK PRESSURE CHECK VALVE. REFUEL VENT VALVE. F-106A, C. G. TRANSFER LINE, REFUEL PILOT VALVE. F-106B, TRANSFER LINE, REFUEL PRESSURE OPERATED SHUTOFF VALVE</p> <p>5 (11), (12) FUEL SYSTEM TANK 1.</p> <p>6 (13), (14) FUEL SYSTEM TANK 1. EXTERNAL TANK SHUTOFF VALVE. TRANSFER LINE.</p> <p>7 (49), (50) TANK PRESSURE SWITCH, BOOST PUMP PRESSURE SWITCH. TRANSFER LINE. EXTERNAL TANK PRESSURE REGULATOR. EXTERNAL TANK FUEL CHECK VALVE.</p> <p>8 (51), (52) EXTERNAL TANK EJECTION RESISTORS.</p> <p>9 (53), (54) VENT LINE</p> <p>10 (23), (24) FUEL SYSTEM TANK 2. VENT LINE.</p> <p>11 (21), (22) ELECTRICAL FUEL QUANTITY RECEPTACLE. FUEL SYSTEM TANK 2. PRESSURE RELIEF VALVE. VENT VALVE. VENT OUTLET FITTING</p> <p>12 (25), (26) FUEL SYSTEM TANK 2. STRUCTURE ACCESS.</p> <p>13 (31), (32) FUEL SYSTEM TANK 2. FLOAT VALVE. VACUUM RELIEF VALVE. VENT LINE. BELLMOUTH.</p> <p>14 (33), (34) FUEL SYSTEM TANK 2. STRUCTURE ACCESS</p> <p>15 (760) REMOTE COMPASS TRANSMITTER AND COMPENSATOR (UPPER SURFACE OF RH LEADING EDGE ONLY.)</p> <p>16 (35), (36) FUEL SYSTEM TANK 2. STRUCTURE ACCESS.</p> <p>17 (47), (48) STRUCTURE ACCESS.</p> <p>18 POSITION LIGHT.</p> <p>19 (89), (90) ELEVON HINGE BOLT. BONDING WIRE.</p> <p>20 (87), (88) ELEVON HINGE BOLT. BONDING WIRE.</p> <p>21 (45), (46) STRUCTURE ACCESS. HYDRAULIC LINES</p> <p>22 (43), (44) ELEVON ACTUATOR BOLT</p> <p>23. ELEVON ACTUATOR.</p> <p>24 (85), (86) ELEVON HINGE BOLT. BONDING WIRE</p> <p>25 (55), (56) ACTUATOR FITTING.</p> | <p>26 (83), (84) ELEVON HINGE BOLT BONDING WIRE.</p> <p>27 (41), (42) FUEL SYSTEM TRANSFER TANK C. G. TRANSFER LINE. FUEL SHUTOFF VALVE. LOW LEVEL PILOT VALVE</p> <p>28 (81), (82) ELEVON HINGE BOLT BONDING WIRE</p> <p>29 (79), (80) ELEVON HINGE BOLT BONDING WIRE</p> <p>30 (77), (78) ELEVON HINGE BOLT BONDING WIRE</p> <p>31 (75), (76) ELEVON HINGE BOLT BONDING WIRE.</p> <p>32 (39), (40) FUEL SYSTEM TRANSFER TANK C. G. TRANSFER LINE. VENT VALVE. REFUEL SHUTOFF VALVE. LOW LEVEL PILOT VALVE. VACUUM RELIEF VALVE. ELECTRICAL FUEL QUANTITY RECEPTACLE</p> <p>33 (73), (74) ELEVON HINGE BOLT BONDING WIRE.</p> <p>34 (71), (72) ELEVON HINGE BOLT BONDING WIRE</p> <p>35 (69), (70) ELEVON HINGE BOLT. BONDING WIRE.</p> <p>36 (67), (68) ELEVON HINGE BOLT BONDING WIRE</p> <p>37 (65), (66) ELEVON HINGE BOLT BONDING WIRE</p> <p>38 (91), (92) ELEVON FITTING</p> <p>39 (61), (62) ELEVON HINGE BOLT BONDING WIRE (ELEVON LOWER SURFACE.)</p> <p>40 (63), (64) ELEVON HINGE BOLT. BONDING WIRE (ELEVON UPPER SURFACE)</p> <p>41 (37), (38) FUEL SYSTEM TRANSFER TANK. F-106A, REFUEL PILOT VALVE, REFUEL VENT VALVE, PRESSURE RELIEF VALVE, AIR CHECK VALVE, LOW LEVEL PILOT VALVE, FUEL SHUTOFF VALVE, REFUEL PRESSURE OPERATED SHUTOFF VALVE. F-106B, TRANSFER LINE, T-TANK PILOT FLOAT VALVE, ELECTRICAL FUEL QUANTITY RECEPTACLE.</p> <p>42 (27), (28) FUEL SYSTEM TANK 3. BOOST PUMP. ENGINE SUPPLY LINE. T-FLAPPER CHECK VALVE.</p> <p>43 (29), (30) FUEL SYSTEM TANK 3. C. G. TRANSFER LINE. F-106A, SOLENOID OPERATED FUEL SCAVENGE VALVE, AIR CHECK VALVE, REFUEL SHUTOFF VALVE.</p> <p>44 (17), (18) FUEL SYSTEM TANK 3. BELLMOUTH. VENT VALVE.</p> <p>45 (19), (20) FUEL SYSTEM TANK 3. FUEL BOOST PUMP. F-106A, C. G. TRANSFER LINE, REFUELING PILOT FLOAT VALVE. F-106B, REFUEL SHUTOFF VALVE, SOLENOID OPERATED SCAVENGE VALVE. TRANSFER LINE</p> <p>46. MAIN WHEEL WELL.</p> <p>47 (7), (8) FUEL SYSTEM TANK 1. BELLMOUTH.</p> |
|---|--|

NOTES

- 1 NUMBERS WITHIN PARENTHESES ARE DOOR STENCIL NUMBERS; THE FIRST NUMBER APPLIES TO THE LEFT WING AND THE SECOND NUMBER APPLIES TO THE RIGHT WING
- 2 WHEN COMPONENTS ARE COMMON TO F-106A AND F-106B AIRPLANES, APPLICABILITY IS NOT GIVEN.

06 02 001 3C 05 05 00

Figure 1-8. Access and Inspection Provisions, Wing

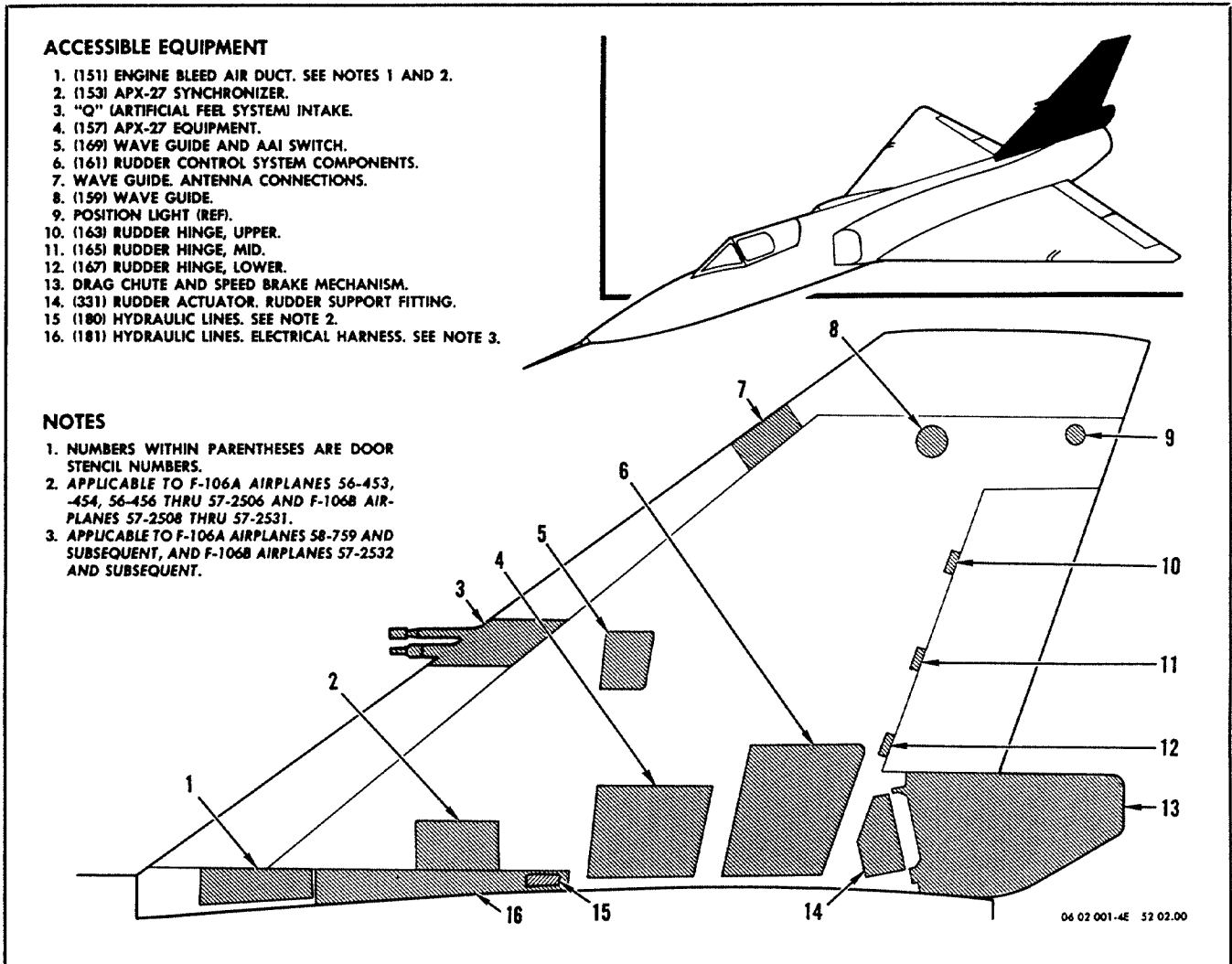
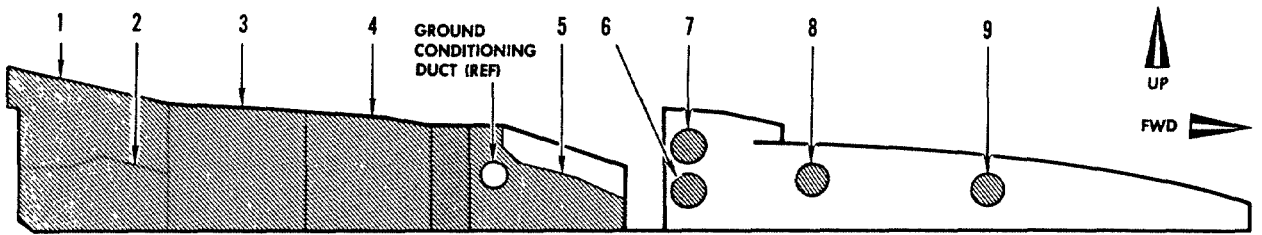
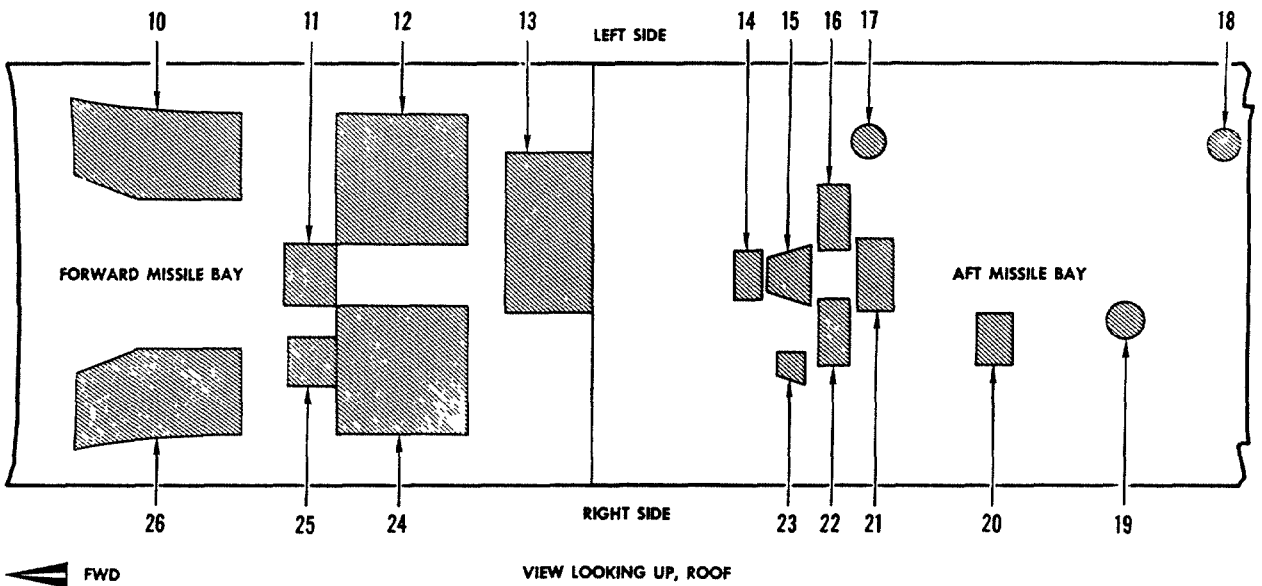

Figure 1-9. Access and Inspection Provisions, Fin



VIEW LOOKING OUTBOARD, LEFT SIDE



VIEW LOOKING UP, ROOF

ACCESSIBLE EQUIPMENT

- 1. PNEUMATIC LINES. HYDRAULIC LINES.
- 2. ELEVATOR CONTROL.
- 3. ELEVATOR CONTROL. PNEUMATIC LINES. HYDRAULIC LINES.
- 4. ELEVATOR CONTROL. FUEL TRANSFER LINE. PNEUMATIC LINES. HYDRAULIC LINES.
- 5. ELEVATOR CONTROL. GROUND CONDITIONING DUCT. PNEUMATIC LINES. HYDRAULIC LINES
- 6. (769) ELEVATOR CONTROL.
- 7. (931) FUEL LINE.
- 8. (767) ELEVATOR CONTROL.
- 9. (933) ELEVATOR CONTROL.
- 10. AIR CONDITIONING SYSTEM DUCTING
- 11. (369) MISSILE INTERVALOMETER.
- 12. (365) AIR CONDITIONING DUCT. RUDDER CABLE PULLEY. VARIABLE RAMP JACKS.

- 13. (367) AIR CONDITIONING SYSTEM COMPONENTS. PNEUMATIC SYSTEM AIR FLASKS. VARIABLE RAMP JACKS.
- 14. PNEUMATIC SYSTEM AIR FLASK FITTING.
- 15. (263) PNEUMATIC SYSTEM AIR FLASK FITTING.
- 16. (261) FUEL TRANSFER LINE.
- 17. (269) THROTTLE TELEFLEX CONDUIT.
- 18. (733) THROTTLE TELEFLEX CONDUIT.
- 19. (943) ELECTRICAL HARNESS CONDUIT. (SEE NOTE 2).
- 20. (730) REFUEL PRESSURE LINE.
- 21. (265) PNEUMATIC SYSTEM AIR FLASK FITTING.
- 22. (262) FUEL TRANSFER LINE.
- 23. (251) ELECTRICAL HARNESSES.
- 24. (366) ARMAMENT SYSTEM RELAYS. ELECTRICAL HARNESSES. RUDDER CABLE PULLEY. VARIABLE RAMP JACKS.
- 25. (371) ARMAMENT CONTROL RELAY BOX. ELECTRICAL HARNESSES.
- 26. ELECTRICAL HARNESSES.

NOTES

- 1. NUMBERS WITHIN PARENTHESES ARE DOOR STENCIL NUMBERS.
- 2. APPLICABLE TO 56-453, -454, 56-456 THRU 57-245, -2453, 57-2465, 58-759 AND SUBSEQUENT; AND 57-246, -2454 THRU -2464, -2466 THRU 57-2506 AFTER INCORPORATION OF TCTO 1F-106-609.

06 02 1382-1A

Figure 1-10. Access and Inspection Provisions, Missile Bay F-106A (Sheet 1 of 2)

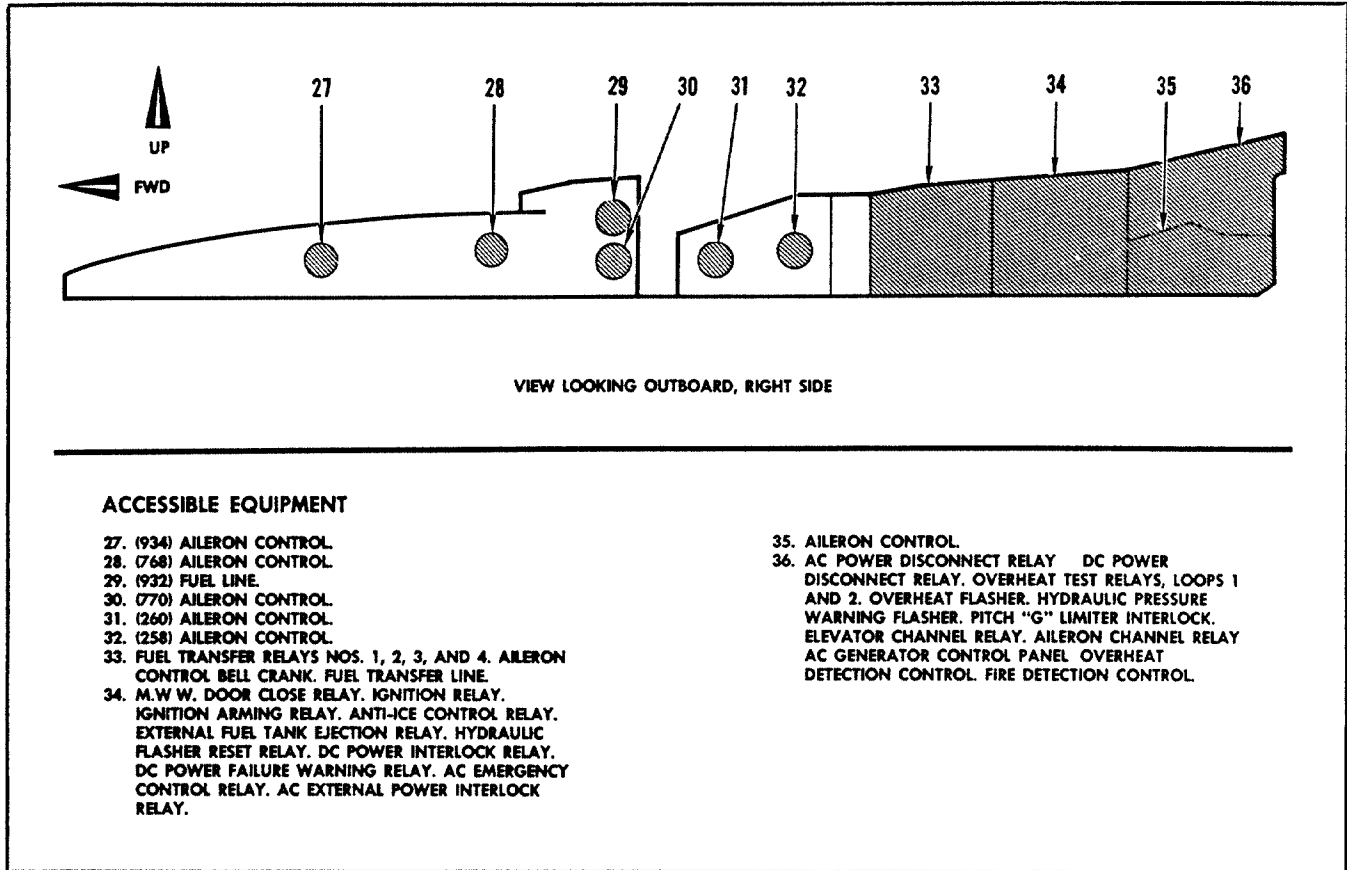
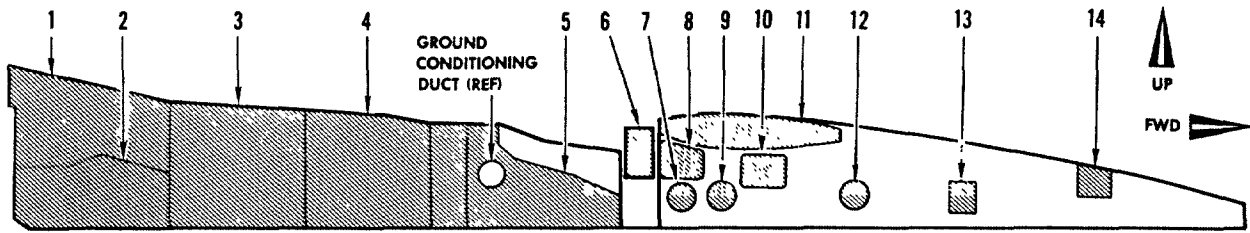
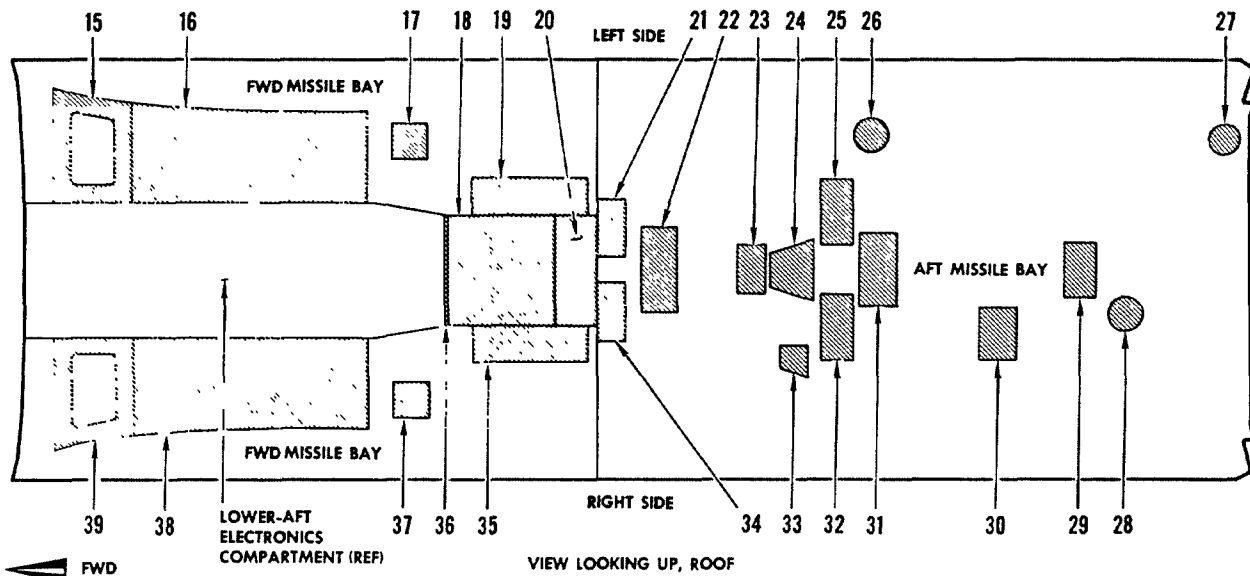

Figure 1-10. Access and Inspection Provisions, Missile Bay F-106A (Sheet 2 of 2)



VIEW LOOKING OUTBOARD, LEFT SIDE



VIEW LOOKING UP, ROOF

ACCESSIBLE EQUIPMENT

- | | |
|--|---|
| <p>1 PNEUMATIC LINES. HYDRAULIC LINES.
 2 ELEVATOR CONTROL
 3 ELEVATOR CONTROL PNEUMATIC LINES HYDRAULIC LINES
 4 ELEVATOR CONTROL FUEL TRANSFER LINE PNEUMATIC LINES HYDRAULIC LINES
 5 ELEVATOR CONTROL GROUND CONDITIONING DUCT PNEUMATIC LINES. HYDRAULIC LINES
 6 (589) AIR CONDITIONING DUCTING.
 7 (549) ELEVATOR CONTROL. FUEL VENT LINE.
 8 (547) FUEL VENT LINE.
 9 (591) ELEVATOR CONTROL. VARIABLE RAMP SYSTEM DRAIN VALVE
 10 (545) FUEL VENT LINE
 11 VARIABLE RAMP, LOWER-AFT ACTUATOR JACK. RUDDER CABLE PULLEY.
 12 (543) ELEVATOR CONTROL.
 13 (541) ELEVATOR CONTROL. FUEL DRAIN VALVE.
 14 (537) ELEVATOR CONTROL. FUEL DRAIN VALVE.
 15 (559) ELECTRICAL HARNESSSES AIR CONDITIONING DUCTING. RUDDER CABLES. PNEUMATIC LINES HYDRAULIC LINES THROTTLE TELEFLEX CONDUIT.
 16 (575) PNEUMATIC LINES. HYDRAULIC LINES BALLISTIC HOSES. THROTTLE TELEFLEX CONDUIT.
 17 (569) VARIABLE RAMP, LOWER-FORWARD ACTUATOR JACK.
 18 (373) AIR CONDITIONING SYSTEM COMPONENTS PNEUMATIC SYSTEM AIR FLASKS. VARIABLE RAMP, UPPER ACTUATOR JACKS.</p> | <p>19. (596) CABIN AIR SENSOR AND SHUTOFF VALVE CABIN TEMPERATURE CONTROL VALVE.
 20. (597) HEAT EXCHANGER.
 21. (599) GROUND COOLING CHECK VALVE DUCT LIP ANTI-ICE REGULATOR
 22. TURBINE DISCHARGE, AIR TEMPERATURE CONTROL VALVE.
 23. PNEUMATIC SYSTEM AIR FLASK FITTING
 24. (619) PNEUMATIC SYSTEM AIR FLASK FITTING.
 25. (611) FUEL TRANSFER LINE.
 26. (623) THROTTLE TELEFLEX CONDUIT
 27. (627) THROTTLE TELEFLEX CONDUIT.
 28 ELECTRICAL HARNESS CONDUIT (SEE NOTE 3).
 29. (641) COOLING LINE.
 30. (1 001) REFUEL PRESSURE LINE.
 31. (621) PNEUMATIC SYSTEM AIR FLASK FITTING.
 32. (612) FUEL TRANSFER LINE
 33. (683) ELECTRICAL HARNESS.
 34. (600) VARIABLE RAMP AIR FLASK DUCT LIP ANTI-ICE REGULATOR. GROUND COOLING CHECK VALVE
 35. (595) ELECTRONIC COOLING AIRFLOW CONTROL
 36. (601) ELECTRICAL HARNESSSES. AIR CONDITIONING DUCTING SEE NOTE 2.
 37. (570) VARIABLE RAMP, LOWER-FORWARD ACTUATOR JACK.
 38. (576) RUDDER CABLES. FUEL SYSTEM DRAIN LINES.
 39. (560) ELECTRICAL HARNESSSES. PNEUMATIC LINES HYDRAULIC LINES AIR CONDITIONING DUCTING RUDDER CABLES</p> |
|--|---|

NOTES

1. NUMBERS WITHIN PARENTHESES ARE DOOR STENCIL NUMBERS.
 2. DOOR IS LOCATED ADJACENT TO AFT FACE OF ELECTRONICS COMPARTMENT AND ROOF OF MISSILE BAY
 3. APPLICABLE TO 57-2508 THRU -2515, -2523, -2528, 57-2532 AND SUBSEQUENT; AND 57-2516 THRU -2522, -2524 THRU -2527, -2529 THRU 57-2531 AFTER INCORPORATION OF TCTO 1F-106-609.

06 02 1383 1A

Figure 1-11. Access and Inspection Provisions, Missile Bay F-106B (Sheet 1 of 2)

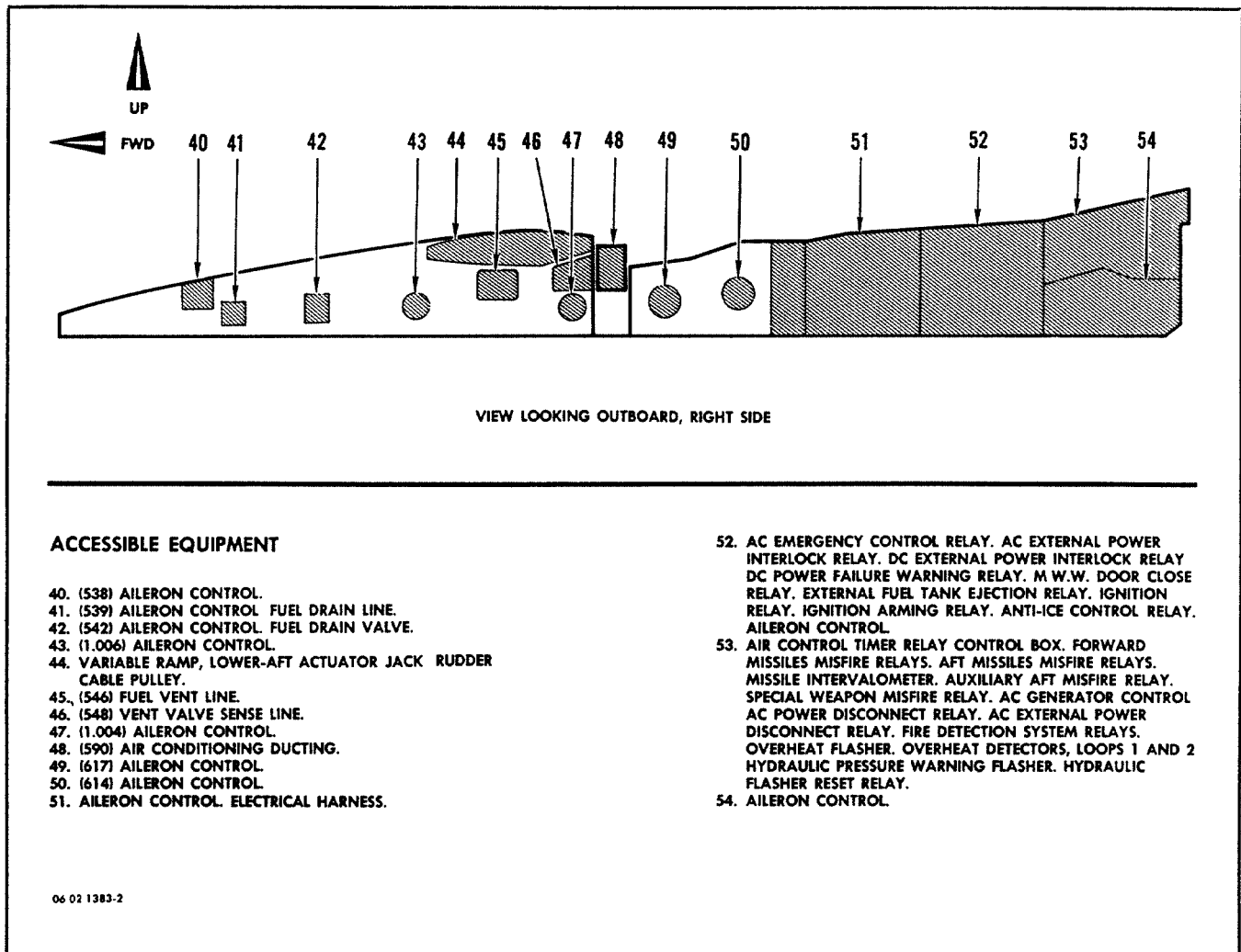

Figure 1-11. Access and Inspection Provisions, Missile Bay F-106B (Sheet 2 of 2)

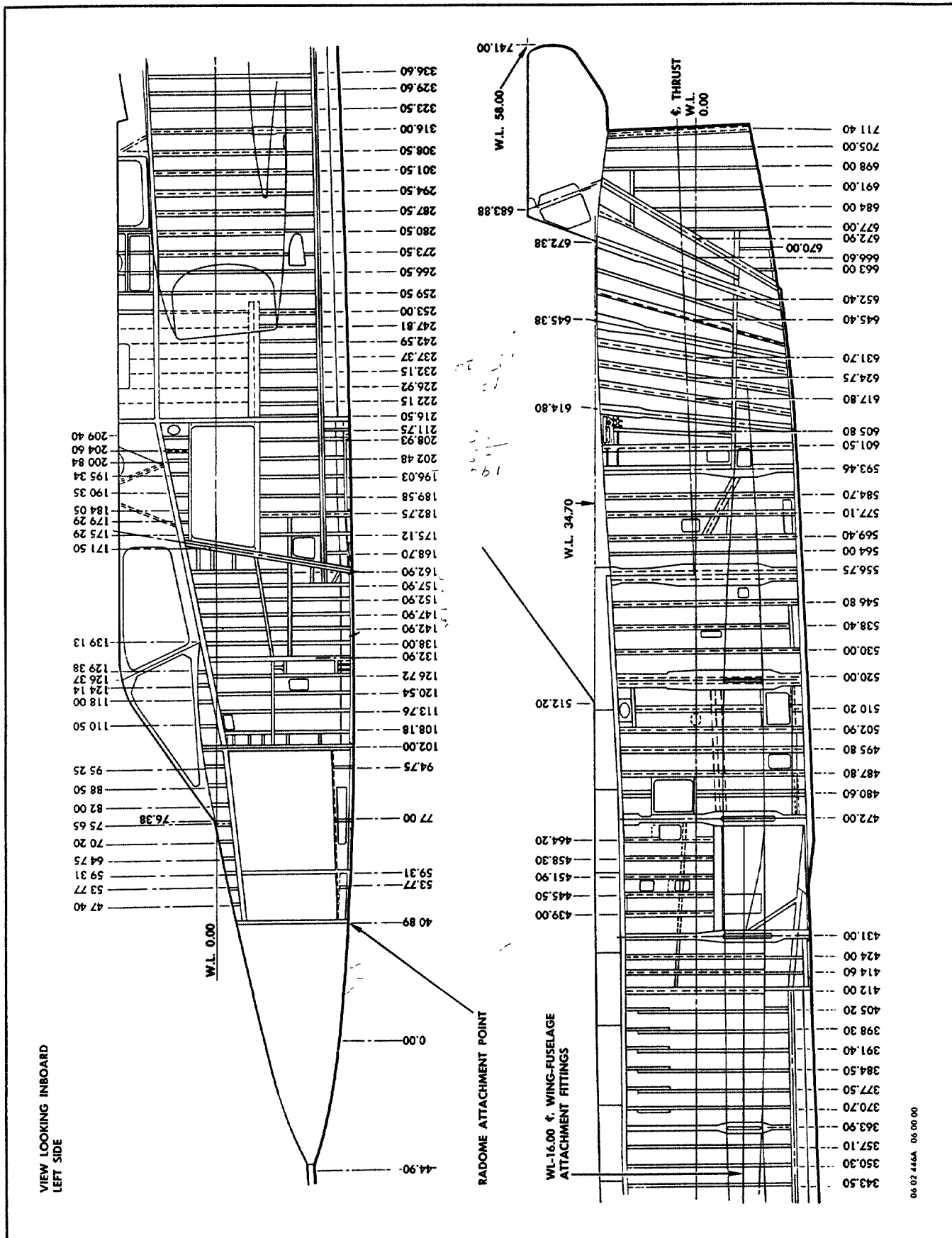

Figure 1-12. Fuselage Stations Diagram, F-106A

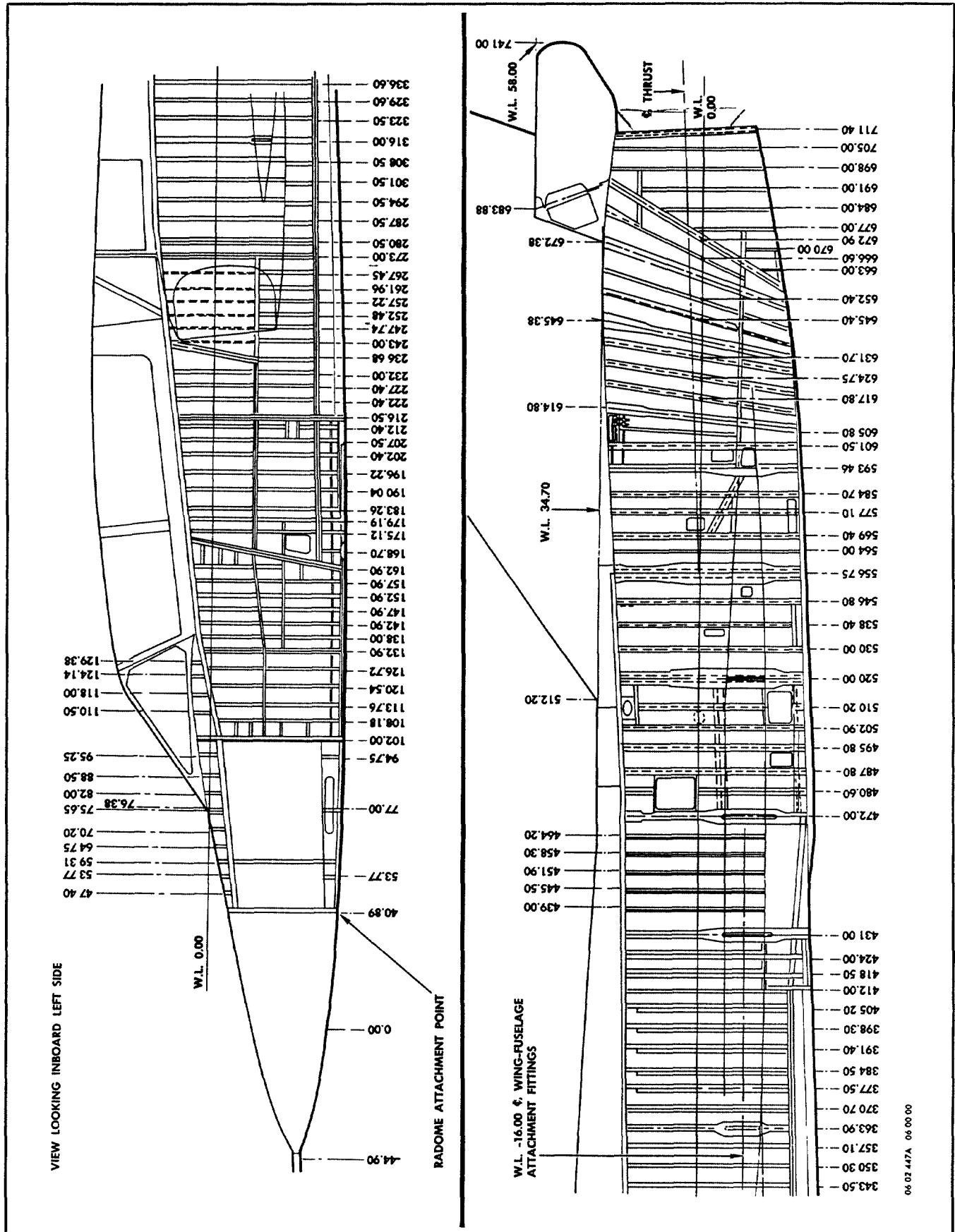

Figure 1-13. Fuselage Stations Diagram, F-106B

Section II

GROUND HANDLING, SERVICING, AND LUBRICATION

<i>Contents</i>	<i>Page</i>
Ground Handling	2-1
Servicing	2-1
Lubrication	2-2
Special Tools and Ground Support Equipment	2-2
General Maintenance Information	2-4

GROUND HANDLING

2-1. GENERAL.

Ground handling operations are defined as towing, parking, jacking, hoisting, servicing, and securing the airplane. Procedures for proper ground handling will vary greatly with existing conditions. For example, adverse weather conditions may require using various protective covers and plugs, releasing tires frozen to the ground, heating the cockpit, or any one of a great many other operations. The performance of some ground handling operations will require several persons to assure that the airplane is not damaged in the process. See figure 2-1 for an illustration showing personnel required for normal towing operations. Refer to T.O. 1F-106A-2-2 when handling the airplane under conditions other than normal or routine. T.O. 1F-106A-2-2 gives detailed ground handling procedures for all conditions which may be

expected to arise and, in addition, gives information on such normal operations as cockpit entry procedure and the installation of ground safety locking devices.



When using slings, dollies, jacks, stands, tools, and other equipment, exercise care to avoid damaging the skin in interior or exterior areas, and especially in pressurized areas. A dent, scratch or cut weakens the skin and may cause subsequent failure.

When parking airplane where overhead clearance is critical, install jack at nose jack point to prevent damage to the vertical stabilizer should nose shock strut or tires deflate.

SERVICING

2-2. GENERAL.

Servicing is divided into two main categories: replenishing and cleaning. Replenishing consists of draining and filling all the components shown on figure 2-2 as required. Detailed information for servicing these components will

be found in T.O. 1F-106A-2-2. Proper servicing includes cleaning the airplane internally as well as externally. Proper materials must be used in cleaning, and adequate precautions must be taken to prevent damage to the airplane and injury to personnel. The proper materials and procedures are outlined in T.O. 1F-106A-2-2.

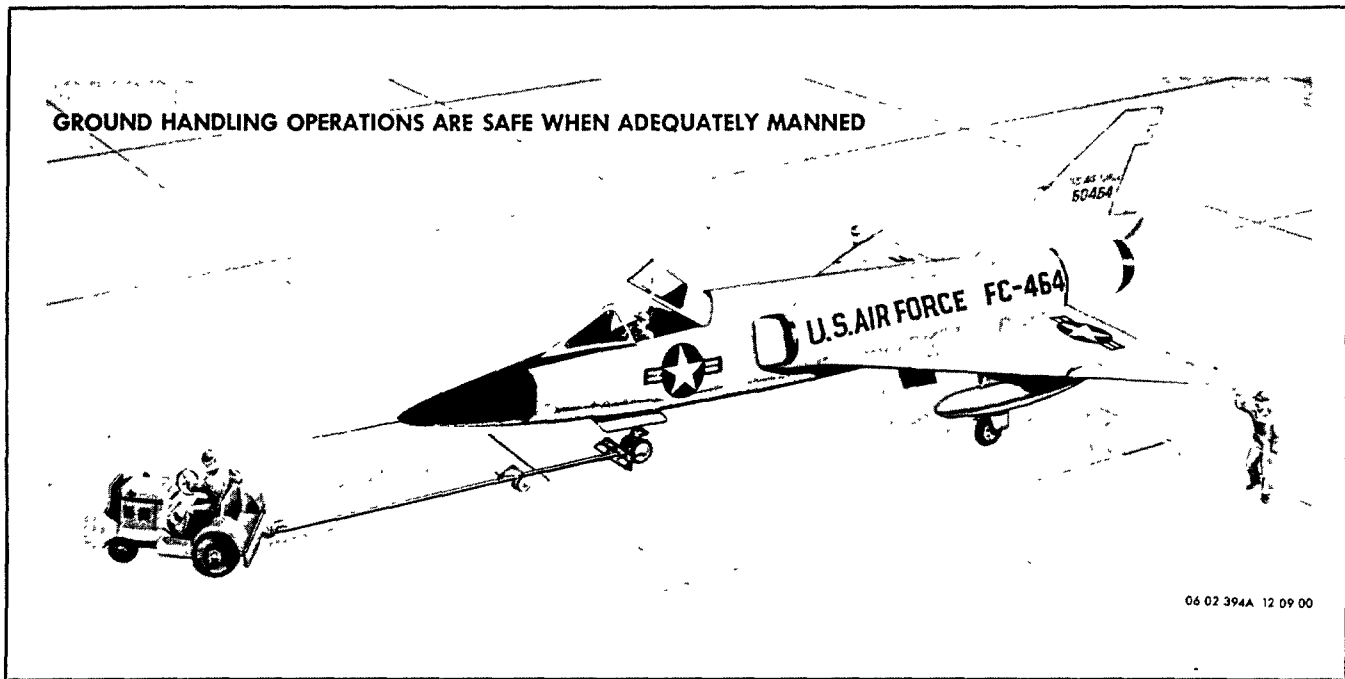

Figure 2-1. Ground Handling

LUBRICATION

2-3. GENERAL.

The airplane areas requiring periodical lubrication are those shown on figure 2-3. Application of the lubricant is accomplished by pressure grease gun, oil can, hand application, or brush application. Detailed procedures

and types of lubricants are outlined in T.O. 1F-106A-2-2. Many components require lubrication during assembly and installation. The manual covering the functional system containing the component in question will outline the procedure for lubrication.

SPECIAL TOOLS AND GROUND SUPPORT EQUIPMENT

2-4. GENERAL.

The list of special tools and ground support equipment required to support the F-106A and F-106B airplane covers a variety of items. This equipment includes items in the nature of tools for performing specific maintenance operations, such as the tool for removing landing gear trunnion pins; safety devices to protect personnel and airplane during maintenance operations; airplane

protective devices such as covers and plugs; and airplane operational equipment such as the high pressure pneumatic system ground air compressor used to charge the high pressure pneumatic system, and the portable generator set used for electrical power. A complete list of special tools and ground support equipment, with information as to their use, will be found in T.O. 1F-106A-2-2.

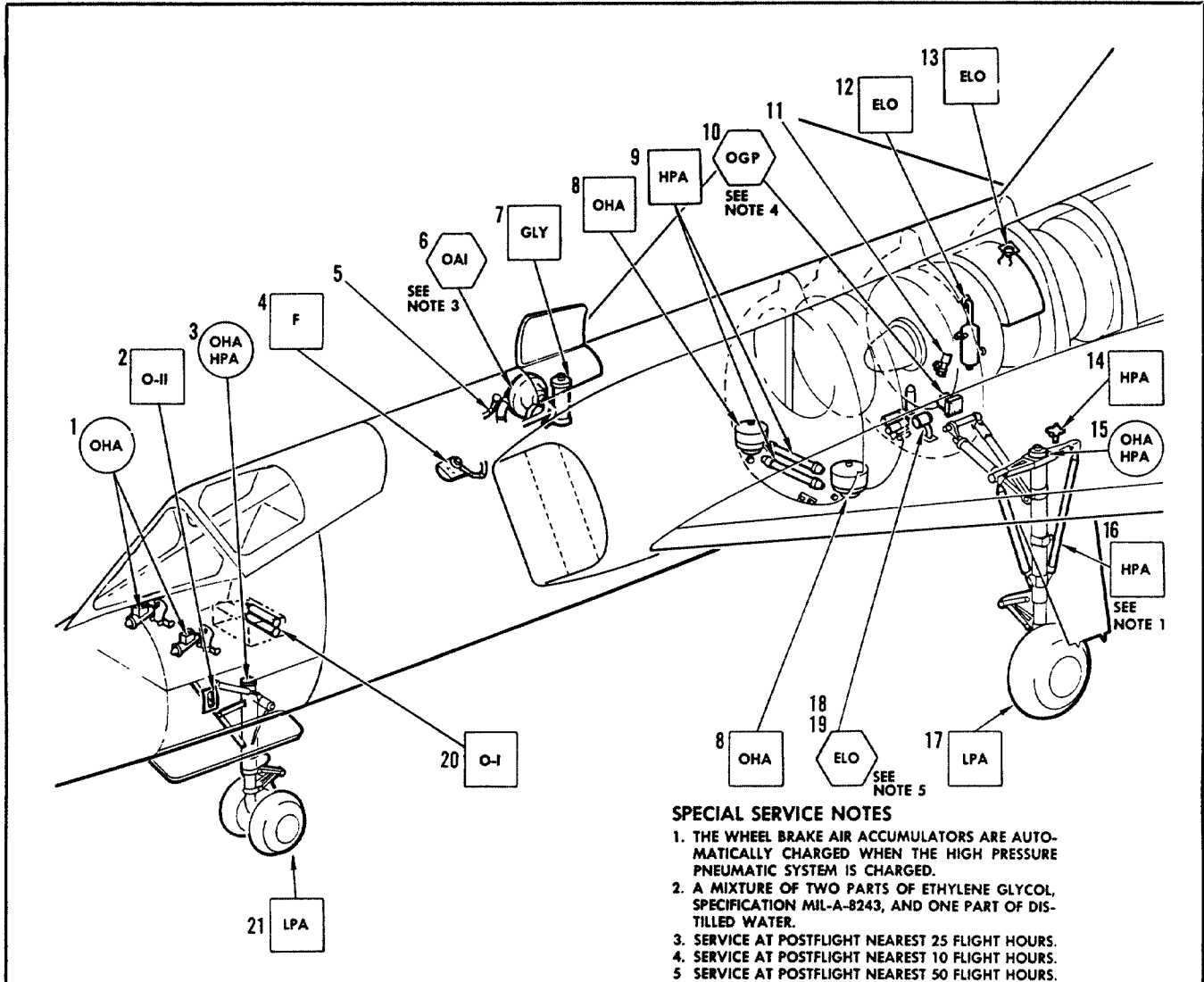

SPECIAL SERVICE NOTES

1. THE WHEEL BRAKE AIR ACCUMULATORS ARE AUTOMATICALLY CHARGED WHEN THE HIGH PRESSURE PNEUMATIC SYSTEM IS CHARGED.
2. A MIXTURE OF TWO PARTS OF ETHYLENE GLYCOL, SPECIFICATION MIL-A-8243, AND ONE PART OF DISTILLED WATER.
3. SERVICE AT POSTFLIGHT NEAREST 25 FLIGHT HOURS.
4. SERVICE AT POSTFLIGHT NEAREST 10 FLIGHT HOURS.
5. SERVICE AT POSTFLIGHT NEAREST 50 FLIGHT HOURS.

LIST OF SERVICING MATERIALS

MATERIAL	SYMBOL	SPECIFICATION	TYPE
FUEL	F	MIL-J-5624	GRADE JP4
ENGINE OIL	ELO	MIL-L-7808	
ANTI-ICING FLUID	GLY	SEE NOTE 2	GRADE A TYPE I GRADE A TYPE II
HYDRAULIC OIL	OHA	MIL-H-5606	
LUBRICATING OIL	OAI	MIL-L-6085	
LUBRICATING OIL	OGP	MIL-L-7870	
OXYGEN (GASEOUS)	O-I	BB-O-925	
OXYGEN (LIQUID)	O-II	BB-O-925	
DRY HIGH PRESSURE AIR	HPA		
LOW PRESSURE AIR	LPA		

FREQUENCY SYMBOLS (DENOTE REFILLING ONLY)

POST FLIGHT (DAILY)

PERIODIC (100 FLIGHT HOURS)

SPECIAL

- | | | |
|---|--|---|
| <ol style="list-style-type: none"> 1. WHEEL BRAKE RESERVOIRS. 2. OXYGEN SYSTEM FILLER CONNECTIONS. 3. NOSE GEAR STRUT. 4. REFUELING FITTING. 5. DEFUELING AIR FITTING. 6. REFRIGERATION UNIT. 7. ANTI-ICING TANK. 8. HYDRAULIC SYSTEM RESERVOIRS. | <ol style="list-style-type: none"> 9. HYDRAULIC SYSTEM ACCUMULATORS. 10. EMERGENCY A/C GENERATOR DRIVE 11. DE-FUELING FITTING. 12. CONSTANT SPEED UNIT OIL TANK. 13. ENGINE OIL TANK. 14. HIGH PRESSURE PNEUMATIC SYSTEM FILLER CONNECTION. 15. MAIN GEAR STRUTS. | <ol style="list-style-type: none"> 16. WHEEL BRAKE AIR ACCUMULATORS. 17. MAIN WHEEL TIRES. 18. PNEUMATIC STARTER. 19. COMBUSTION STARTER 20. SURVIVAL KIT EMERGENCY OXYGEN BOTTLES. 21. NOSE WHEEL TIRES. |
|---|--|---|

06 02 389H 12 00 00

Figure 2-2. Airplane Servicing Points

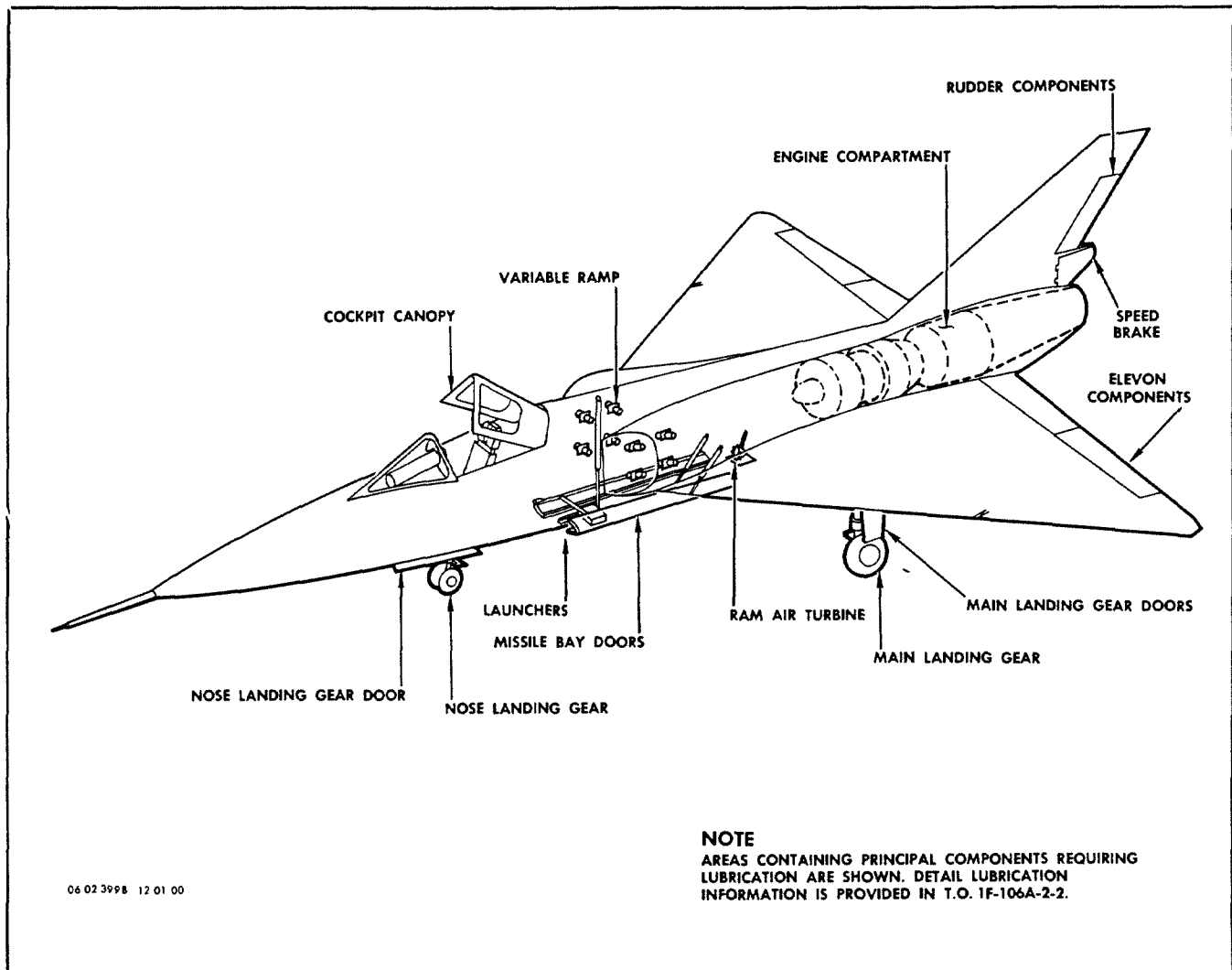

Figure 2-3. Lubrication

GENERAL MAINTENANCE INFORMATION

2-5. WALKWAYS.

There are no marked walkways on the airplane. The following precautions must be taken whenever it is necessary to walk on wings for cleaning or maintenance purposes: Place protective pads on the wing surface, or wear suitable cloth-shoe moccasins; do not step near the leading edge, elevon, or wing tip installations; walk along spars or ribs, which can be identified by lateral or longitudinal rivet patterns in the skin. Areas alongside the fuselage may be walked on if properly protected, but do not use the tail cone fairing as a foot support while working on the vertical fin. Do not, under any circumstances, step or crawl over the bleed air duct dorsal fairing on top of the fuselage.

2-6. PERSONNEL SAFETY.

Various clamps, lockpins, and other safety devices are provided for protection of personnel while performing maintenance on the airplane. Install applicable safety device prior to starting work. Some of these safety devices are illustrated on figures 2-4 and 2-5. When working with pneumatically operated systems, the following precautions must be observed to prevent injuries due to air blast, and to prevent inadvertent operation of the system in work, or other pneumatically operated systems not in work:

- a. Bleed high pressure pneumatic system prior to disconnecting lines or removing components in any system powered by high pressure air. Refer to T.O. 1F-106A-2-3 for procedure.

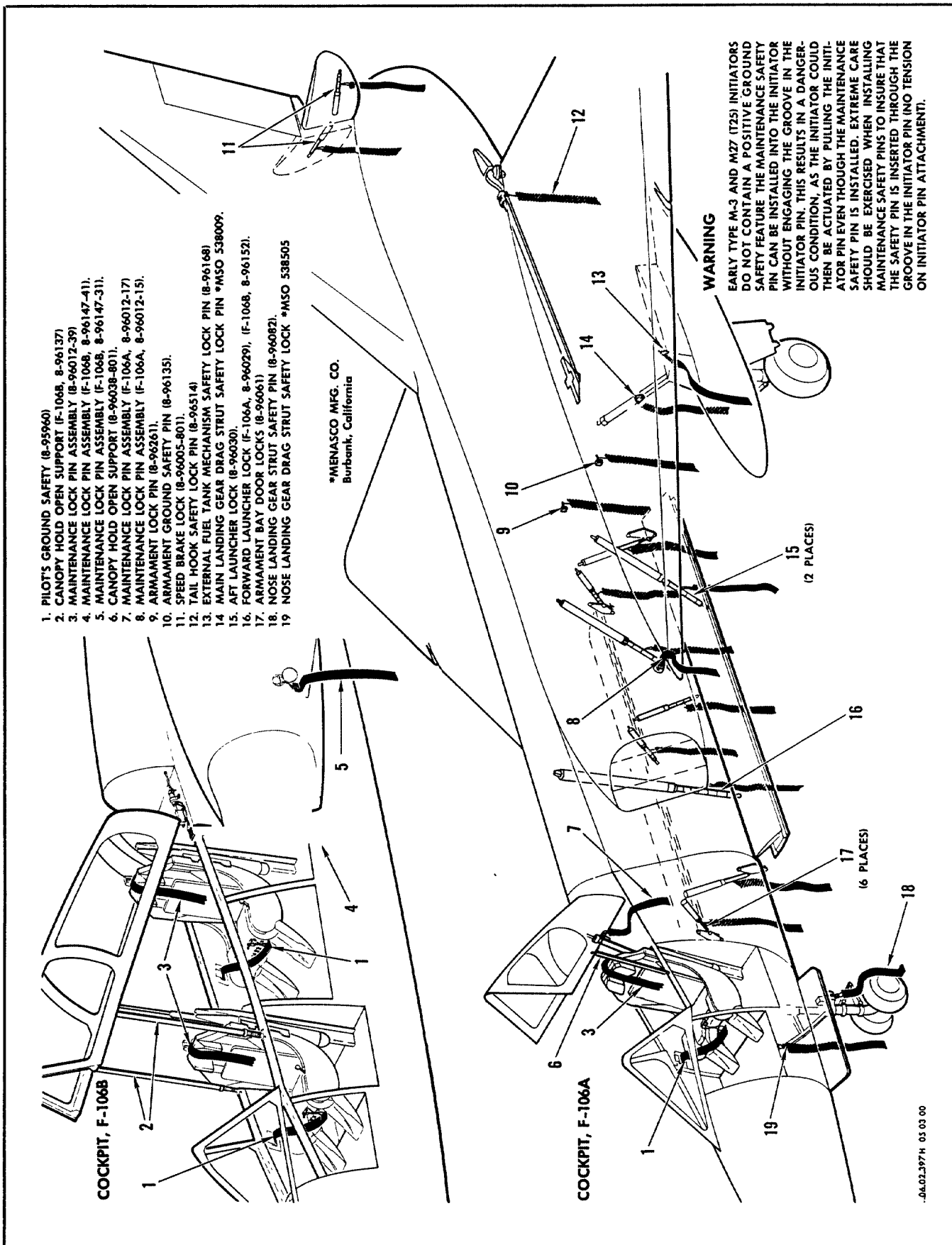

Figure 2-4. Safety Locks

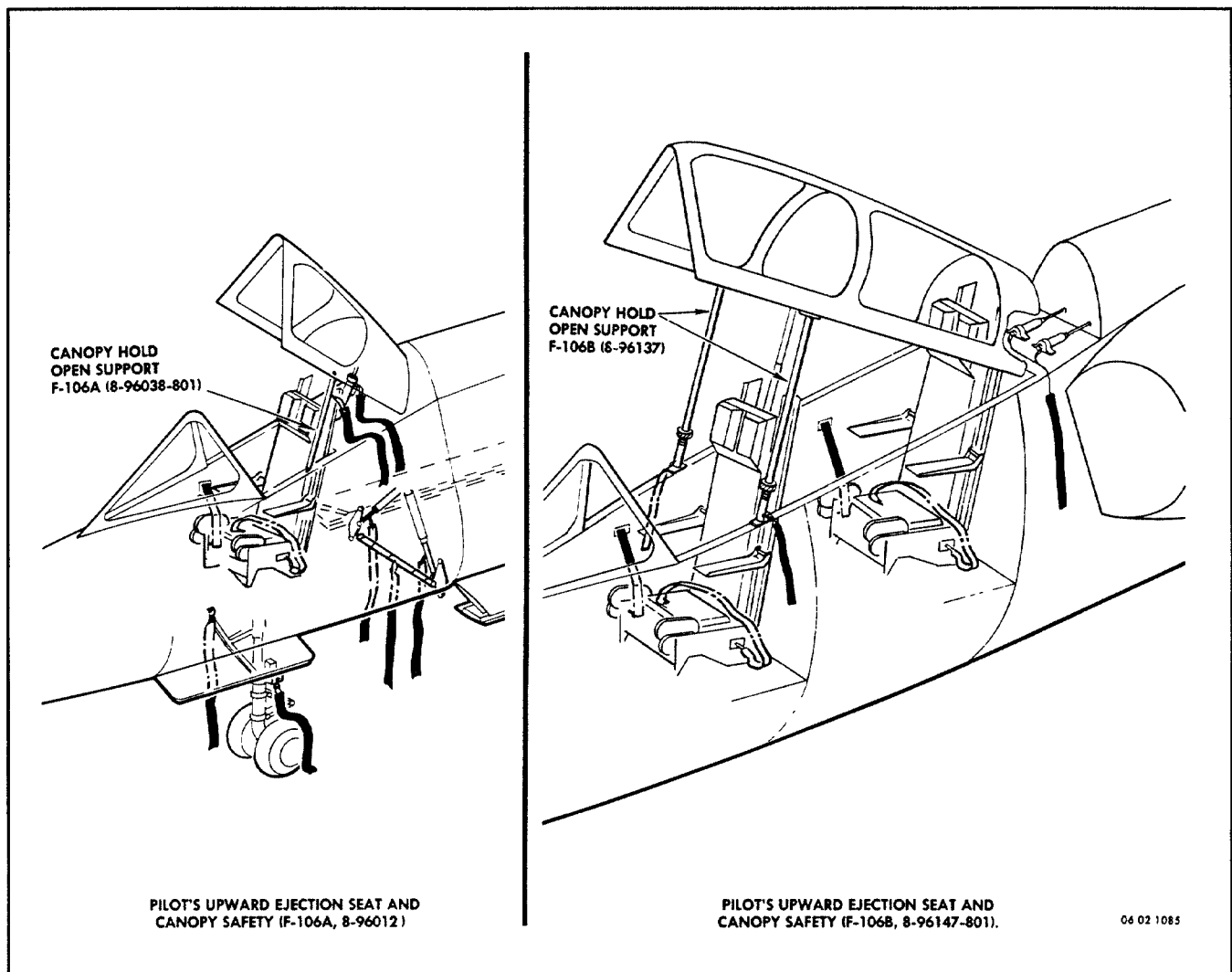

Figure 2-5. Pilot's Upward Ejection Seat and Canopy Safety

b. Check that all components of systems powered by high pressure air are properly connected and that control valves and switches for all pneumatically-operated systems are properly positioned before charging the high pressure pneumatic system. Refer to T.O. 1F-106A-2-3 for charging procedure.

2-7. ENGINE AIR INLET AND TAIL PIPE DANGER AREAS.

The dangers existing in the engine air inlet and tail pipe areas during engine run-up must constantly be kept in mind. The tail pipe area can be unsafe up to 15 minutes after engine shutdown. Awareness of this danger must become a fixed habit similar to the habit of not getting too near the propeller of a propeller driven airplane. Figure 2-6 illustrates the danger areas and should be referred to frequently to remind personnel of the areas in which this danger exists.

2-8. BOLT TORQUE VALUES.

Tightening of nut-bolt combinations must be accomplished by rotating the nut in all cases except where

inaccessibility or fixed anchorage of the nut requires rotating the bolt head. A general rule is to tighten the nut-bolt combination to the low side of the torque range shown on figure 2-7. This must be the rule for cold weather operations, to allow for expansion that will occur as the temperature rises.

2-9. When using cotter pins or lockwire to safety nut-bolt combination, tighten nuts to low side of torque range, as shown on figure 2-7, unless otherwise noted, and, if necessary, continue tightening until next slot aligns with hole. Nuts must not be loosened to obtain alignment.

2-10. When it is necessary to torque bolts from the head side, determine whether bolt turns freely in hole, or whether friction exists between bolt and hole before nut is engaged; then proceed as follows:

a. If bolt turns freely in hole before engaging nut, high side of torque range should be approached whenever possible, but should not be exceeded unless otherwise noted.

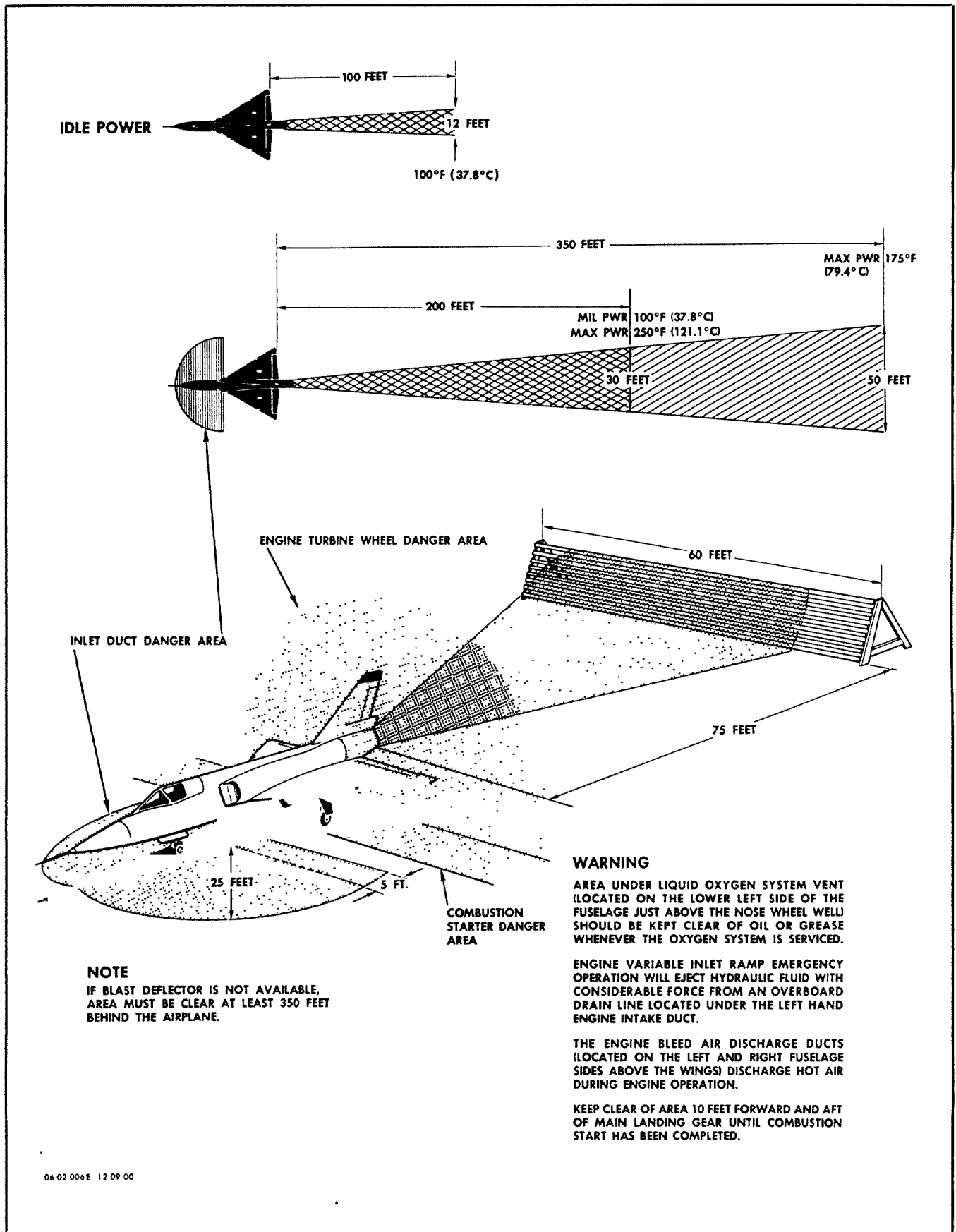

Figure 2-6. Danger Areas

BOLT SIZE	STEEL BOLTS				ALUMINUM ALLOY BOLTS (AN365D NUTS)		
	NUT TYPES AN365 AND AN310		NUT TYPES AN364 AND AN320		BOLT SIZE	INCH LBS	FOOT LBS
	INCH LBS	FOOT LBS	INCH LBS	FOOT LBS			
10-32	20-25	—	12-15	—	3/16	10-14	—
1/4-28	50-70	—	30-40	—	1/4	20-35	—
5/16-24	100-140	9-12	60-85	5-7	5/16	50-75	4-6
3/8-24	160-190	13-16	95-110	8-9	3/8	80-110	7-9
7/16-20	450-500	38-42	270-300	23-25	7/16	100-140	8-12
1/2-20	480-690	40-57	290-410	24-34	1/2	170-220	14-18
9/16-18	800-1000	67-83	480-600	40-50	5/8	400-460	34-38
5/8-18	1100-1300	92-108	660-780	55-65			
3/4-16	2300-2500	192-208	1300-1500	109-125			
7/8-14	2500-3000	209-250	1500-1800	125-150			
1-14	3700-5500	308-458	2200-3300	184-275			
1-1/8-12	5000-7000	417-583	3000-4200	250-350			
1-1/4-12	9000-11000	750-916	5400-6600	450-550			

When using torque wrench adapters, if the desired torque is known, the torque wrench dial reading may be found as follows

T_w = Wrench dial reading.

T_a = Desired torque at end of adapter.

L = Lever length of torque wrench.

A = Length of adapter (center distance).

FORMULA — $T_w = \frac{T_a \times L}{L + A}$

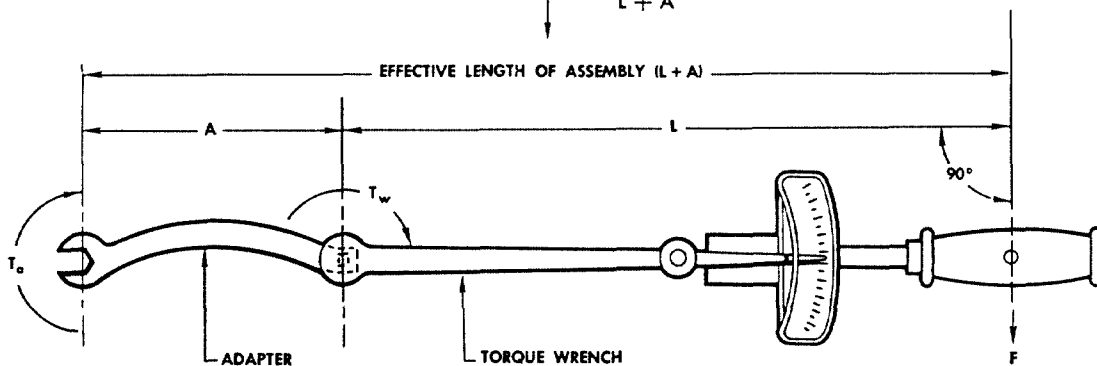

06 02 026A 12 09 00

Figure 2-7. Bolt Torque Values

b. If friction exists between bolt and hole, torque bolt in hole before engagement of nut, and note torque reading as bolt starts to turn. Add this value to high side of appropriate torque value, and use the total for final torque value. Do not exceed this total unless otherwise noted.

2-11. LUBRICATION OF BOLT THREADS.

The lubrication of bolt threads is as follows:

- a. Lubricate threads only of aluminum alloy bolts with anti-seize compound, Specification MIL-T-5544.
- b. Do not lubricate the threads of steel bolts.

2-12. TUBING AND HOSE MAINTENANCE.

When performing maintenance involving tubing or hose assemblies, it is well to keep in mind the system involved, and what function the tube or hose performs in the system. Only in this way can you know what to expect when you disconnect a tube or hose assembly. Identification and system function is provided by code bands installed around tubing and hoses. Figure 2-8 illustrates these bands and explains the code. When working with oxygen lines it is extremely important that no oil, grease, or other petroleum base substances come in contact with the tubing or hose fittings. Hydraulic lines must be kept absolutely free of foreign matter which might clog minute openings in hydraulic components and thereby impair the function of the system involved. Whenever a tube or hose assembly is disconnected, the end fittings and the openings on the component must be capped immediately. These caps must remain in place until the tube or hose assembly is reconnected. Replacement tubing and hose assemblies must be kept capped until installed and ready to be connected to the end fittings. When connecting hose assemblies, do not allow the hose to kink or twist. See figure 2-9 for torque values. When a hose assembly is tempo-

rarily removed from the airplane, avoid placing it where it may be damaged by heat, oil, or grease. Heat can cause deterioration, not immediately apparent, that may cause the hose to fail later while in service.

2-13. QUICK-DISCONNECT COUPLINGS.

Quick-disconnect couplings are used on various systems of the F-106A and F-106B airplanes. These couplings are of the self-sealing type, and are used where frequent uncoupling of lines is required. The coupling consists of two self-sealing halves, which will automatically seal and prevent draining of the system when disconnected. Extreme caution must be taken to keep couplings free of foreign matter which would prevent continuity of the system. See figure 2-10 for an illustration of quick-disconnect couplings.

2-14. SAFETY WIRING.

Safety wire is used on various assemblies throughout the airplane to prevent components from loosening or changing position due to stress and vibration. Assemblies that require safetying may include items such as locking collars, nuts, wing nuts, switches, switch covers, plugs, and cannon plugs. All assemblies that require safetying will have provisions (holes) for safety wire. Ascertain that all assemblies requiring safetying are secure and safetyed before completion of maintenance. The manual covering the assembly in question will contain the procedure for safetying. See figure 2-11 for approved methods of safety wiring.

2-15. ELECTRICAL SYMBOLS.

Electrical symbols are illustrated and explained on figure 2-12. The symbols facilitate the use of wiring diagrams when performing maintenance involving electrical circuits.

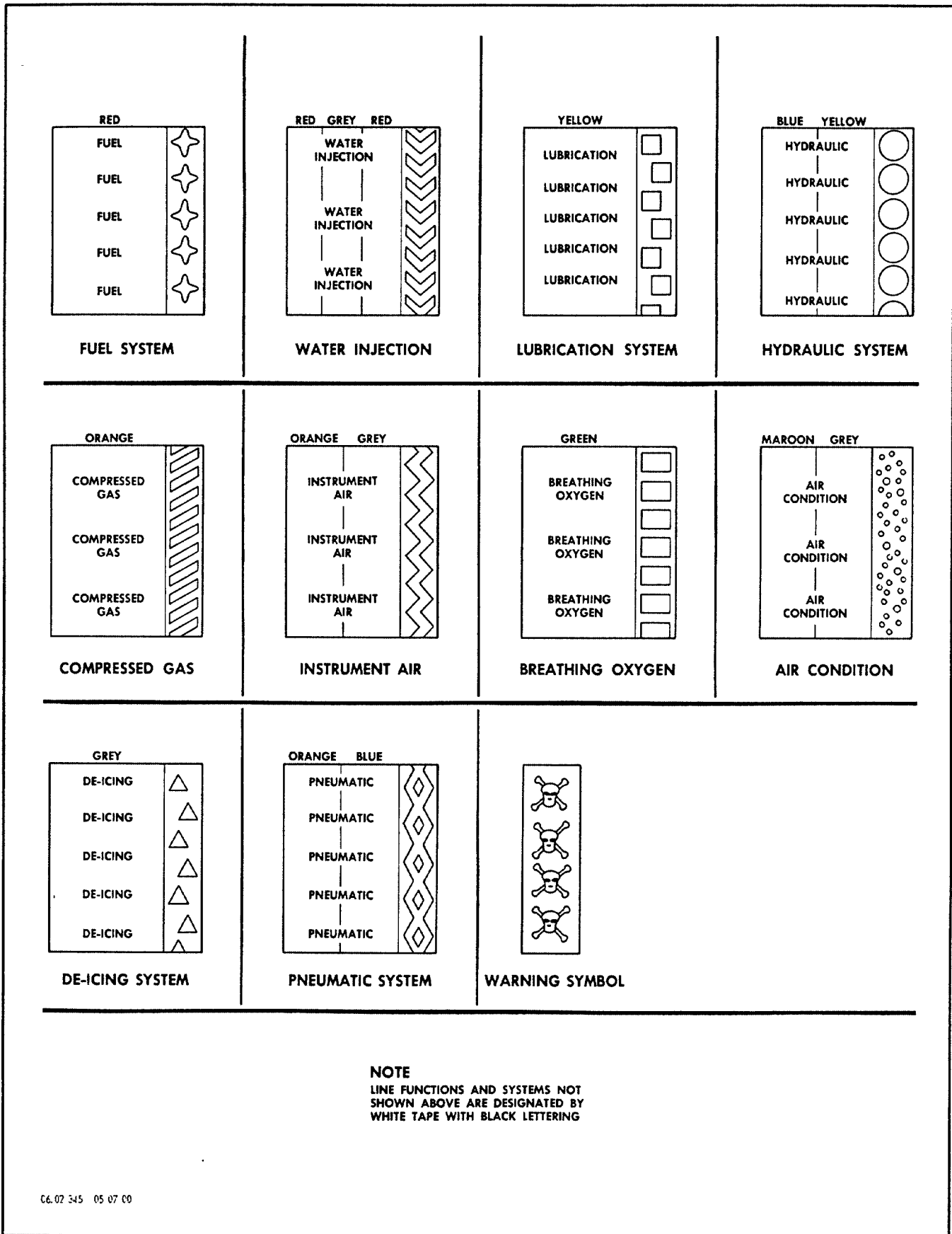

NOTE
LINE FUNCTIONS AND SYSTEMS NOT SHOWN ABOVE ARE DESIGNATED BY WHITE TAPE WITH BLACK LETTERING

Figure 2-8. Identification of Tube Coding

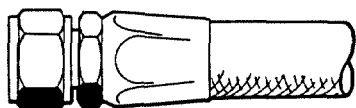

INSTALLATION OF HOSE ASSEMBLIES

- a. Lubricate threads on hydraulic hose fittings with the system hydraulic fluid.
- b. Lubricate threads on pneumatic hose fittings with grease, Specification MIL-L-4343.
- c. Lubricate threads on oxygen hose fittings with MIL-T-5542; see warning.
- d. Torque hose assembly fittings to values shown in right-hand column of table below.

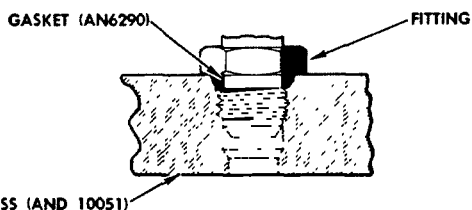

INSTALLATION OF FLARED NON-POSITIONING TYPE FITTINGS

- a. Lubricate gasket with applicable lubricant; see sheet 2 and warning.
- b. Install gasket in groove on fitting.
- c. Screw fitting assembly into boss until it bottoms tightly against boss.

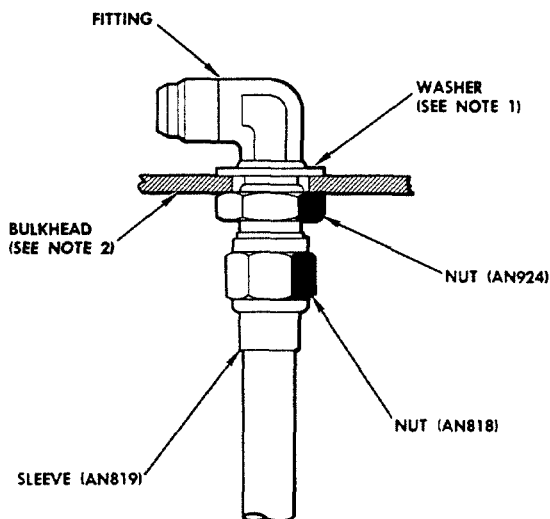

**INSTALLATION OF FLARED-TUBE,
STRAIGHT-THREADED CONNECTORS**

NOTES

- 1. USE AN AN690 WASHER, 1/16 INCH THICK FOR FITTINGS SIZE —6 OR SMALLER, AND A WASHER 3/32 INCH THICK FOR FITTINGS LARGER THAN SIZE —6. A WASHER IS NOT REQUIRED WHERE FITTING END HAS HEX INSTEAD OF FLANGE SHOWN.
- 2. FITTING WITH BULKHEAD END CONFORMING TO AND 10057 IN SIZE —6 AND SMALLER MAY BE USED THROUGH BULKHEADS UP TO 3/16 INCH MAXIMUM THICKNESS. FITTING WITH BULKHEAD END CONFORMING IN SIZE —8 AND LARGER, AND ALL SIZES OF AN832 FITTINGS MAY BE USED THROUGH BULKHEADS UP TO 3/8 INCH MAXIMUM THICKNESS.

WRENCH TORQUE VALUES FOR FLARED TUBING NUTS (INCH-POUNDS)

TUBING OD INCHES (HOSES ID)	5052-0 ALUMINUM ALLOY TUBING FLARE AND 10061 OR AND 10078		6061-T6 ALUMINUM ALLOY TUBING FLARE AND 10061 OR AND 10078		STEEL AND TITANIUM TUBING FLARE AND 10061		HOSE ASSEMBLY FITTINGS MS28740 AN6292 AN6270	
	MIN	MAX	MIN	MAX	MIN	MAX	MIN	MAX
3/16	35	60	35	70	90	100	70	100
1/4	40	65	70	120	135	150	70	120
*5/16	60	80	80	130	180	200	85	180
*3/8	75	125	130	180	270	300	100	250
*1/2	150	250	300	400	450	500	210	420
5/8	200	350	430	550	650	700	300	480
3/4	300	500	650	800	900	1000	500	850
1	500	700	900	1100	1200	1400	700	1150
1-1/4	600	900	—	—	—	—	—	—
1-1/2	600	900	—	—	—	—	—	—

* SEE NOTE 3

NOTES

- 1. WHERE ALUMINUM ALLOY TUBING IS USED IN STEEL FITTINGS, TORQUE VALUES FOR ALUMINUM ALLOY TUBING WILL APPLY.
- 2. WHERE ALUMINUM ALLOY THREADED PARTS ARE MATED WITH STEEL THREADED PARTS, TORQUE VALUES FOR ALUMINUM ALLOY TUBING WILL APPLY.
- 3. APPLICABLE TO 5052-0 ALUMINUM ALLOY TUBING USED IN LIQUID OXYGEN SYSTEM ONLY, SUBSTITUTE THE FOLLOWING VALUES:
5/16 — 100 MIN, 125 MAX
3/8 — 200 MIN, 250 MAX
1/2 — 300 MIN, 400 MAX

WARNING

DO NOT USE PETROLEUM LUBRICANTS WITH OXYGEN FITTINGS

06 02 025-1C 03 24 00

Figure 2-9. Tubing Torque Values (Sheet 1 of 2)

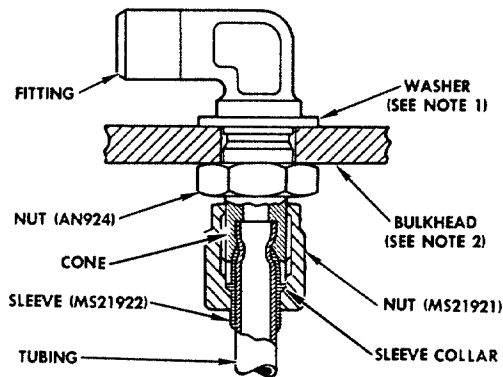

NOTES:

- 1 USE WASHER AN960, .062 THICK FOR FITTINGS SIZE -6 OR SMALLER, AND .031 THICK FOR FITTINGS SIZE -8 OR LARGER WHEN BULKHEAD IS .187 THICK OR LESS. WHEN BULKHEAD IS THICKER THAN .187, WASHER IS NOT REQUIRED PROVIDED HOLE IN BULKHEAD IS EQUAL TO THE HOLE IN APPLICABLE AN960 WASHER. SIZES -8 AND LARGER MAY BE USED THROUGH BULKHEADS UP TO 281 MAXIMUM THICKNESS. ENDS IN ACCORDANCE WITH MS33515, STYLE E, MAY BE USED THROUGH BULKHEADS UP TO 187 MAXIMUM. WASHER IS NOT REQUIRED WHERE FITTING END HAS HEX INSTEAD OF FLANGE SHOWN, PROVIDED HOLE IN BULKHEAD IS EQUAL TO HOLE SIZE IN APPLICABLE AN960 WASHER.
- 2 FITTING WITH BULKHEAD END CONFORMING TO MS33515, STYLE S, IN SIZES -6 AND SMALLER MAY BE USED THROUGH BULKHEADS UP TO 250 MAXIMUM THICKNESS. SIZES -8 AND LARGER AND ALL SIZES OF MS21903 MAY BE USED THROUGH BULKHEADS UP TO 375 MAXIMUM THICKNESS.

**INSTALLATION AND TORQUE PROCEDURES FOR
FLARELESS TUBE FITTINGS**

- a. Check that all parts are free from dirt, burrs and foreign particles.
- b. Lubricate fittings and tube sleeve. See gasket selection table.
- c. Install tube in fitting. Check that sleeve is in full contact with cone seat and that nut makes full contact with sleeve collar.
- d. Tighten tube nut with wrench until sleeve is in full contact with tube. This will be indicated by a sharp rise in torque. Nut must tighten smoothly until this contact is made.

CAUTION

NEVER OVERTIGHTEN A LEAKING MS FITTING. THIS WILL DEFORM THE SLEEVE OR TUBE AND CAUSE ADDITIONAL LEAKS.

- e. Tighten nut an additional 1/8 turn more (two hex flats of nut), no more or less. Fittings must be firmly held during this procedure to prevent rotation.
- f. If leak occurs after installation, disconnect fitting and check for foreign material that may prevent tight seal. Check inside diameter of the affected tube at the sleeve area using ball gage test. If tube collapse is too great, replace tube. If tube passes test, reinstall and repeat tightening procedures.

TUBE BALL GAGE TEST CHART

TUBE O.D.	WALL THICKNESS					
	.022	.028	.035	.042	.049	.058
BALL SIZE						
3/16	1/8	7/64	3/32	5/64	1/16	-
1/4	3/16	11/64	5/32	9/64	1/8	7/64
3/8	5/16	19/64	9/32	17/64	1/4	15/64
1/2	7/16	27/64	13/32	25/64	3/8	23/64
5/8	9/16	35/64	17/32	33/64	1/2	31/64
3/4	11/16	43/64	21/32	41/64	5/8	39/64
1	15/16	59/64	29/32	57/64	7/8	55/64
1-1/4	1-3/16	1-11/64	1-5/32	1-9/64	1-1/8	1-7/64
1-1/2	1-7/16	1-27/64	1-13/32	1-25/64	1-3/8	1-23/64

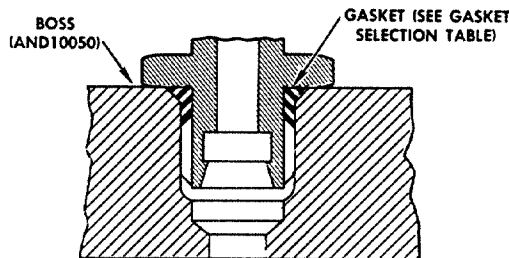

**INSTALLATION OF FLARELESS NON-POSITIONING
TYPE FITTINGS**

- a. Lubricate the gasket in appropriate liquid (see table).
- b. Install gasket on the fitting as shown in detail.
- c. Screw the fitting assembly into the boss until it bottoms tightly on the boss as shown.

GASKET SELECTION TABLE

APPLICATION	GASKET AN OR MS NO.	APPROPRIATE LUBRICANT FOR GASKETS AND TUBE FITTINGS
HYDRAULIC	AN6290	MIL-H-5606
PNEUMATIC	AN6290	MIL-L-4343
ENGINE OIL	AN6290	MIL-L-7808
FUEL	MS29512	MIL-H-5606
OXYGEN	AN6290	MIL-T-5542
OTHER USES	AN6290	FLUID USED IN SYSTEM

WARNING

DO NOT USE PETROLEUM LUBRICANTS WITH OXYGEN FITTINGS.

06 02 025 2F 03 24 00

Figure 2-9. Tubing Torque Values (Sheet 2 of 2)

CAUTION

INSPECT LOCK TEETH ON LOCK SPRING FOR EVIDENCE OF DAMAGE BEFORE MAKING A CONNECTION. COUPLINGS SHOULD ALWAYS BE COVERED WHEN DISCONNECTED TO PREVENT CONTAMINATION BY FOREIGN MATTER.

**QUICK DISCONNECT COUPLING
TORQUE VALUES**

COUPLING DASH NO.	COUPLING SIZE	FOOT LBS.
-4	1/4	10
-5	5/16	10
-6	3/8	15
-8	1/2	15
-10	5/8	20
-12	3/4	20
-16	1	30
-20	1-1/4	30
-24	1-1/2	30

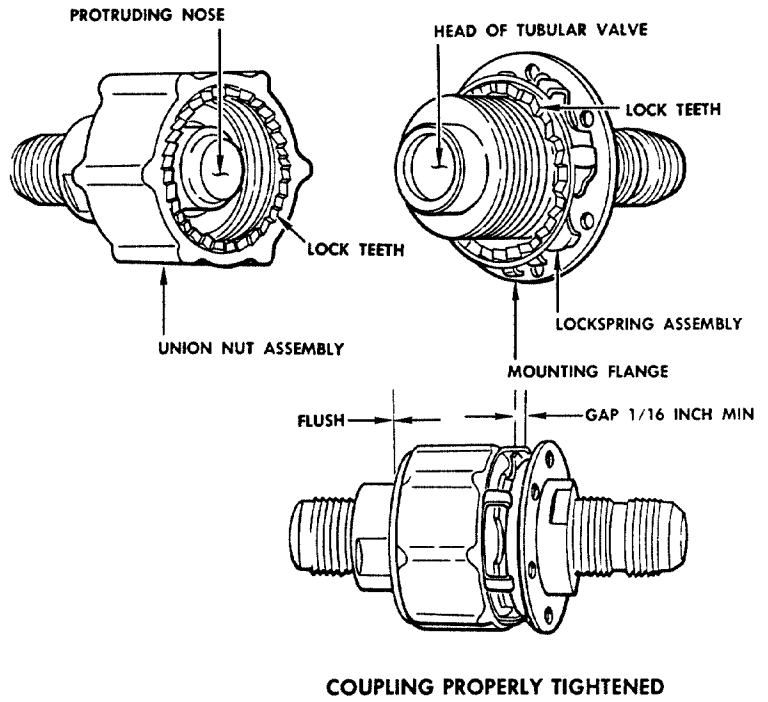

06 02 0278 05 08 00

Figure 2-10. Quick Disconnect Couplings

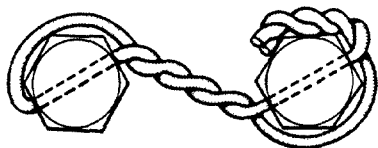

TWO UNIT SAFETY-WIRING

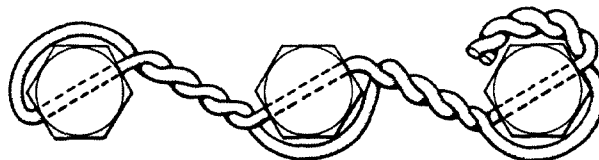

THREE UNIT SAFETY-WIRING

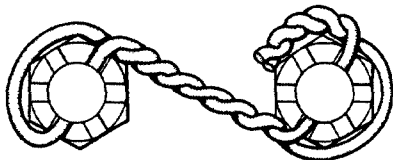

SAFETY-WIRING CASTELLATED NUT

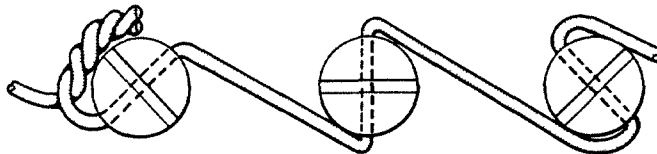

SINGLE STRAND SAFETY-WIRING

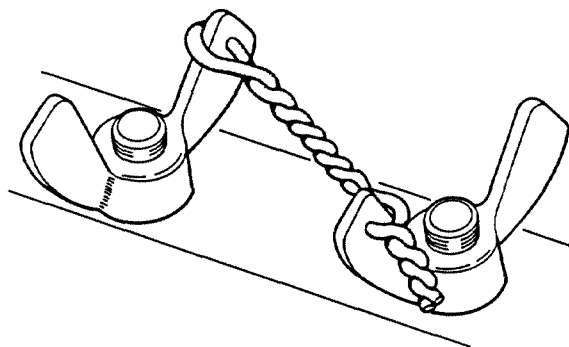

SAFETY-WIRING WING NUTS

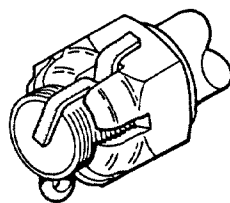

COTTERING OF
CASTELLATED NUT

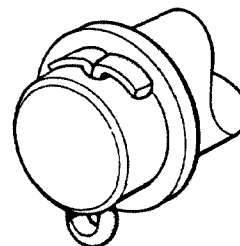

CLEVIS PIN COTTERING

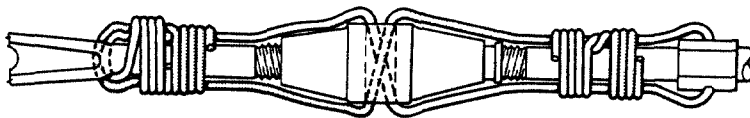

NOTE
BEFORE ADJUSTING TURNBUCKLES, INSURE THAT TURNBUCKLES ARE STARTED EVENLY, HOLD BOTH TERMINALS TO PREVENT TWISTING OF CABLES AND TIGHTEN TURNBUCKLES WITH A TOOL INSERTED THROUGH THE SAFETY WIRE HOLE OF THE TURNBUCKLE. AFTER FINAL ADJUSTMENT, THE MAXIMUM EXPOSED THREADS ON EITHER END OF THE TURNBUCKLE IS THREE FULL THREADS.

TURNBUCKLE SAFETYING

Figure 2-11. Safety Wiring

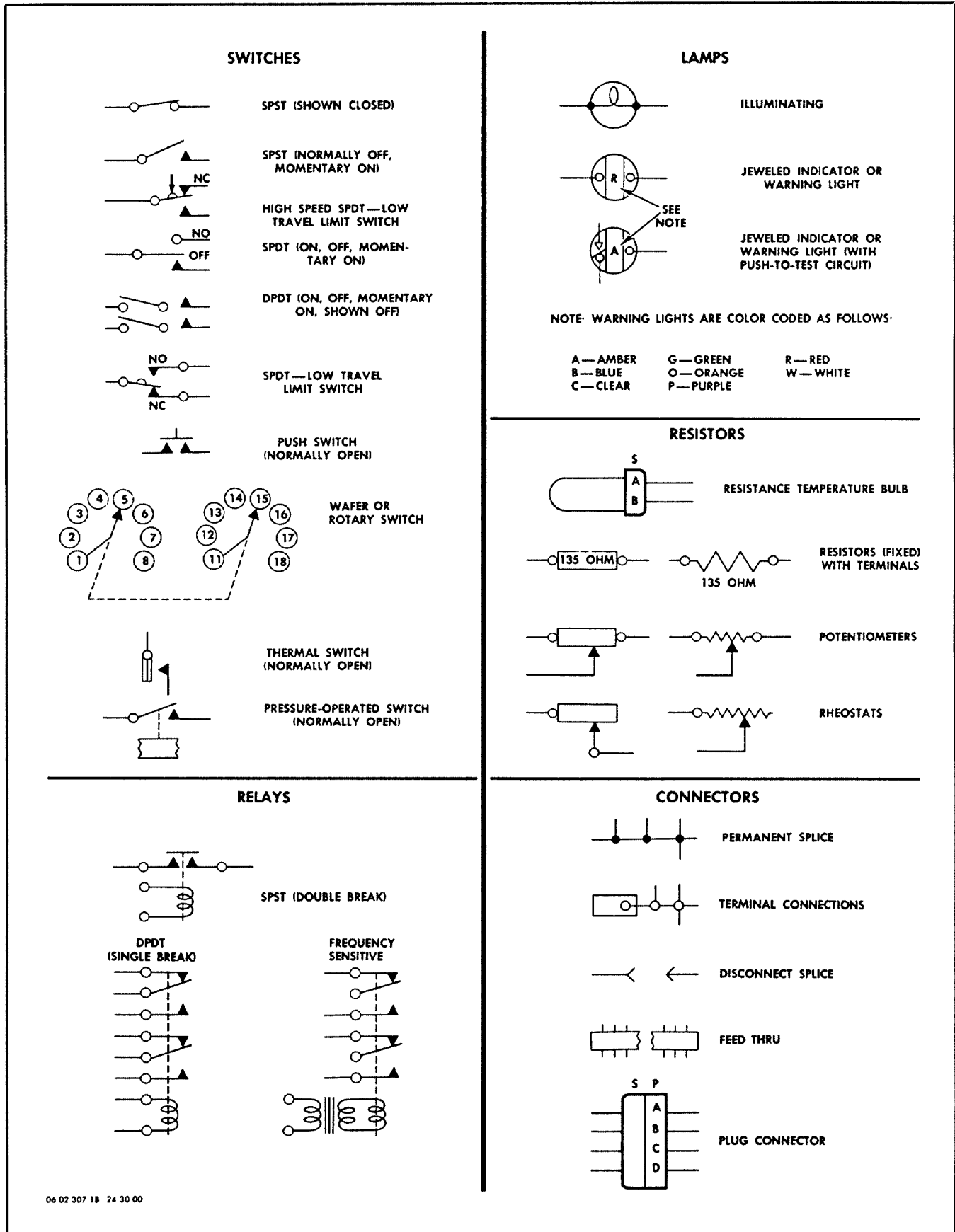

06 02 307 18 24 30 00

Figure 2-12. Electrical Symbols (Sheet 1 of 2)

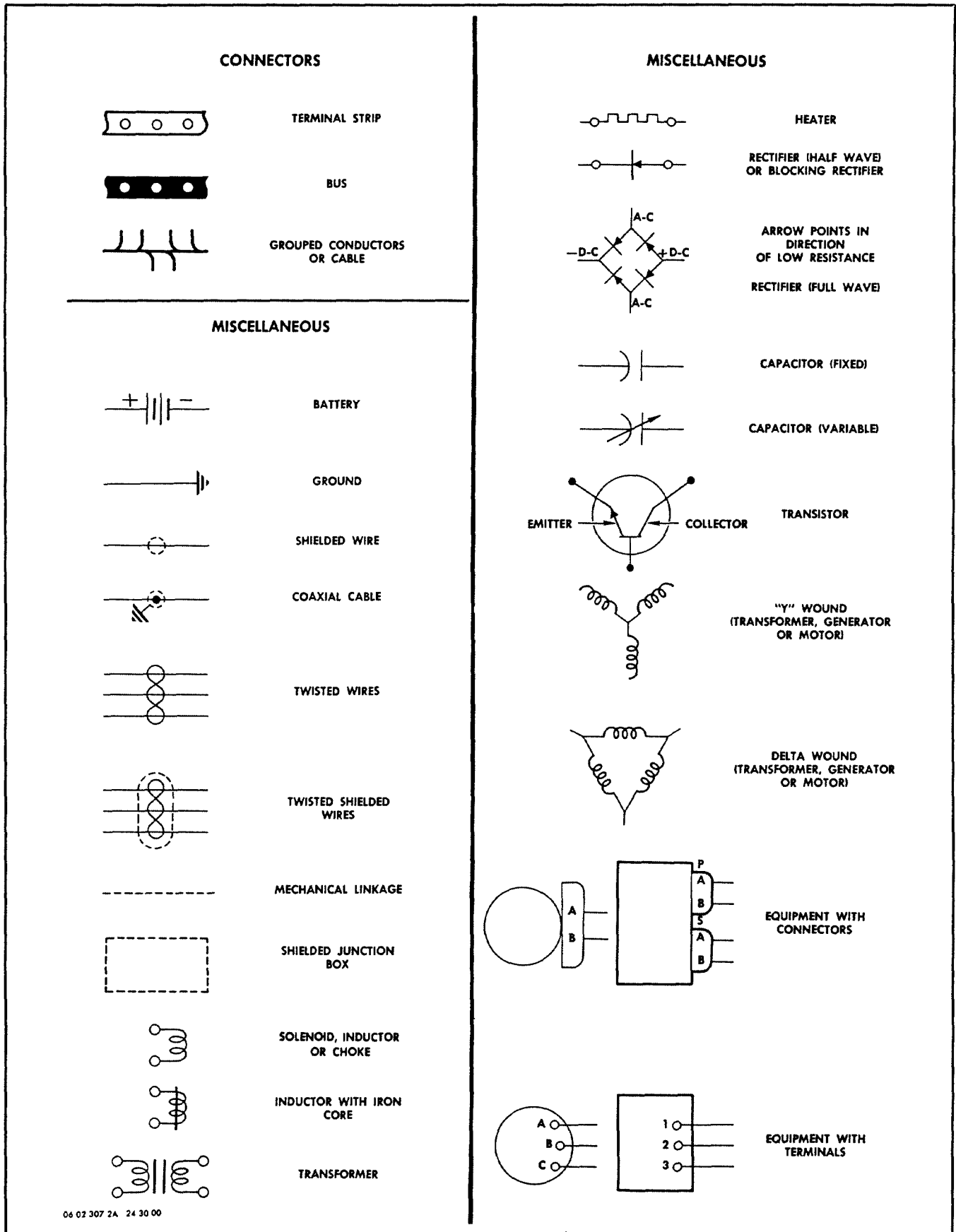

04 02 307 2A 24 30 00

Figure 2-12. Electrical Symbols (Sheet 2 of 2)

Section III

AIRFRAME GROUP

<i>Contents</i>	<i>Page</i>
Fuselage	3-1
Fuselage Compartment Doors	3-1
Wing	3-1
Canopy and Seat Operating Systems	3-2
Pilot Escape System (Upward Ejection)	3-11
Pilot Escape System (Rotational Upward Ejection)	3-12
Emergency Arresting System	3-14

FUSELAGE

3-1. GENERAL.

The fuselage is distinguished by its "waisted" configuration, and by the cheek-located engine air inlet ducts. The three major sections which make up the fuselage are: the radome, the main fuselage section, and the tail cone. The radome and tail cone are attached to the main fuselage section with bolts and are readily detachable. The

main fuselage section includes the cockpit with its jettisonable canopy, the nose and main wheel wells, the forward electronics compartment, the aft electronics compartment, the fuselage fuel tank, the air conditioning compartment, the missile bay, the hydraulic accessories compartment and the engine compartment. T.O. 1F-106A-2-2 contains specific information concerning the airframe of the F-106A and F-106B airplanes.

FUSELAGE COMPARTMENT DOORS

3-2. GENERAL.

The fuselage compartment doors are secured in place by latches or stressed panel fasteners to provide easy access to compartments for servicing and maintenance. Many smaller access doors, fastened with screws, provide access to individual items of equipment. Most fuselage doors are sealed by the "formed gasket" method. The remaining doors are sealed by either tubular or diaphragm type seals.

Compartment doors should not be left open unless necessary, since open doors permit dust and foreign matter to enter the compartments. Also, the sharp corners of some doors can be a hazard to personnel working in the area. When a door is opened or removed, examine the seal for cracks or damage. If any damage is found, the seal should be replaced. T.O. 1F-106A-2-2 gives complete information on replacement or repairing all types of seals.

WING

3-3. GENERAL.

The wing is of full cantilever construction with a delta configuration, and consists of a right and left panel, removable cambered leading edges, and wing tips, inte-

gral fuel tanks, and integral trailing edges. The wing panels are bolted to the fuselage through forged fittings on the wing spars and fuselage frames. Elevons, which combine aileron and elevator action, are installed at the trailing edge of each wing panel. The elevon outboard

hydraulic actuator is housed in a fairing on the underside of the wing. Each wing incorporates a "slotted" leading edge which serves as an aid to control flight at low speeds. The main landing gear is attached to the lower surface of the wing, and retracts into the landing gear

wells in the bottom of the fuselage. Fuel tank access doors are installed in the lower surface of each wing. Wing fittings, to accommodate attachment of external tanks, are installed in the wings between spars three and four.

CANOPY AND SEAT OPERATING SYSTEMS

3-4. GENERAL.

F-106A and F-106B airplanes are equipped with jettisonable canopies and ejection type seats which permit both normal and emergency exit. In normal operation the canopy is raised or lowered with the aid of a combination electric-ballistic actuating cylinder. When closed, the canopy is locked by latching hooks, operated by a control handle inside the cockpit or an external handle located beneath the left windshield. A "CANOPY UNLOCKED" warning light illuminates when the canopy is not firmly latched in the closed position. Under emergency conditions, the canopy can be jettisoned, and the seat and pilot ejected, by means of a ballistic system operated from controls on the pilot's seat. The canopy can also be jettisoned by means of an external emergency handle. The following paragraphs describe the canopy and seat subsystems. Refer to T.O. 1F-106A-2-2 for detailed information regarding these systems.

3-5. ELECTRIC CANOPY ACTUATING SYSTEM.

The cockpit canopy is normally opened or closed by operation of the combination electric-ballistic actuating cylinder. The canopy is controlled from within the cockpit by a toggle switch mounted on the pilot's right-hand console. An identical switch is located adjacent to the exterior canopy latch control handle. Electrical power may be furnished by the airplane's generating system, from an external ground unit, or from a battery which is a component of the canopy power package. The canopy actuation may be stopped at any position during ground operation by releasing the toggle switch. See figures 3-1 thru 3-4 for illustrations of the electric canopy normal operation and system schematic.

3-6. CANOPY SEAL SYSTEM.

The airplane canopy is sealed against rain, dust, leakage, and loss of cockpit pressurization by two rubber seals, one of which is inflatable. The non-inflatable seal is installed at the aft edges of the windshield while the inflatable seal is installed around the edges of the canopy. When the canopy is closed and locked, partially cooled low pressure air (engine bleed air) from the heat exchanger will inflate the canopy seal. A canopy seal selector valve is connected to the canopy latch mechanism. The valve opens to allow the seal to inflate when the

canopy latching hooks are in the locked position. Relief and safety valves regulate seal pressure and prevent over-pressurization. An emergency pressurization system for the cockpit and canopy seal will provide air pressure to the canopy seal system in event a loss of normal supply pressure occurs at high altitudes. A test fitting is located in the nose wheel well to facilitate operational checkout of the canopy seal system. Refer to T.O. 1F-106A-2-2 and T.O. 1F-106A-2-6 for complete coverage of this system.

3-7. PILOT'S SEAT (UPWARD EJECTION).

The pilot's seat assembly is of the ballistic ejection type. The seat is equipped with canopy jettison and seat ejection controls, a height adjustment mechanism, a seat belt, shoulder straps, an inertia reel, and pilot's personal leads disconnect assemblies. The belt and shoulder straps are fastened by a single clasp in the pilot's lap. The clasp is normally released by hand, and is automatically released during seat ejection. The shoulder straps are attached to the spring-loaded inertia reel, which allows the pilot limited shoulder movement, but prevents his being thrown forward in case of an accident. The inertia reel is attached to the back of the seat, and is locked automatically when a rapid pull (equivalent to 2 or 3 "G" deceleration) force is exerted on the harness assembly. An electrical actuator and two screw jacks at the top of the seat provide the pilot with 4.25 (± 0.03) inches of vertical seat adjustment. The actuator is controlled by a switch on the right-hand armrest. The arm guards protect the pilot's arms during seat ejection. These guards are stowed in the down position by latches which are released when either of the two canopy jettison and seat ejection control handles is raised. This permits them to swing into an upright position and lock in place for seat ejection. See figure 3-5 for an illustration of the upward ejection seat. Refer to T.O. 1F-106A-2-2 for complete coverage of this system.

3-8. PILOT'S SEAT (ROTATIONAL UPWARD EJECTION).

The rotational upward ejection seat assembly is equipped with a canopy jettison (only) control handle, a canopy jettison and seat ejection (both) control ring, and an emergency harness release handle. Other controls located on the seat assembly are the seat adjustment control switch, rudder pedal adjustment switch and the inertia

WARNING

CANOPY HOLD-OPEN SUPPORTS MUST BE INSTALLED TO PREVENT INADVERTENT CANOPY CLOSING UNLESS THE CANOPY IS OPENED ONLY MOMENTARILY.

CAUTION

DO NOT OPERATE CANOPY ACTUATOR FOR MORE THAN 3 MINUTES IN ANY 20 MINUTE PERIOD AS DAMAGE TO THE ACTUATOR MOTOR WILL RESULT.

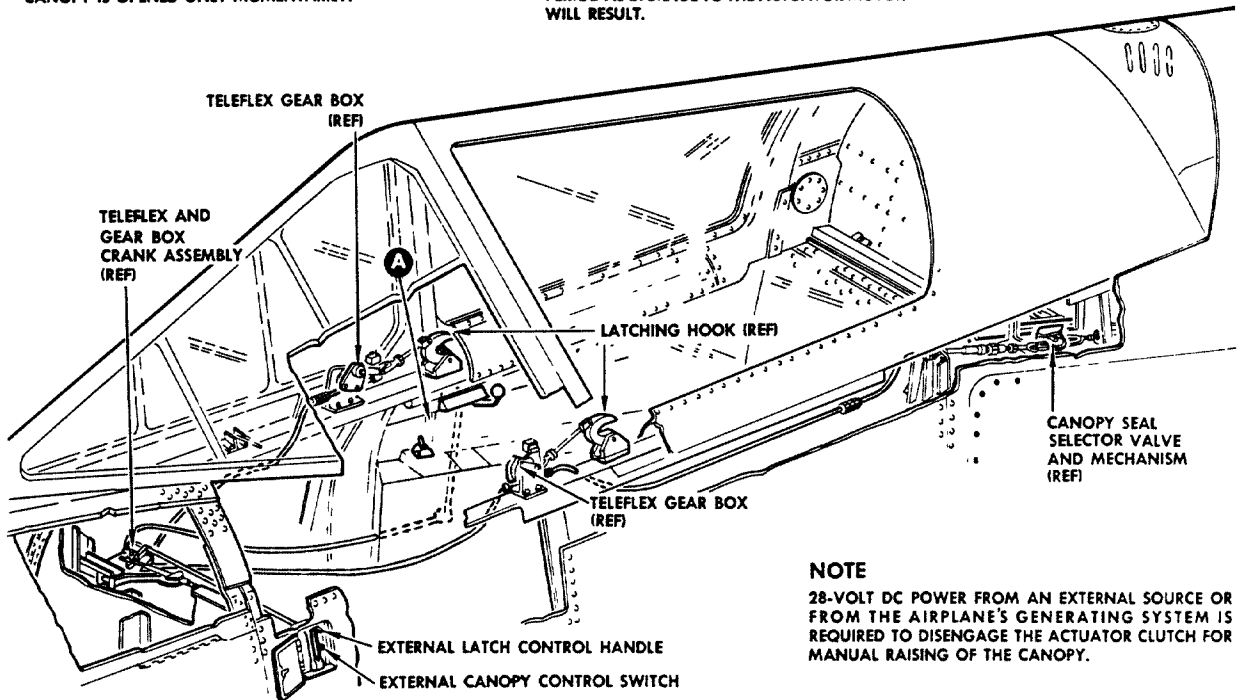
**NOTE**

28-VOLT DC POWER FROM AN EXTERNAL SOURCE OR FROM THE AIRPLANE'S GENERATING SYSTEM IS REQUIRED TO DISENGAGE THE ACTUATOR CLUTCH FOR MANUAL RAISING OF THE CANOPY.

TO OPEN CANOPY FROM OUTSIDE COCKPIT

- Open access door beneath left windshield and pull external latch control handle outboard to unlock canopy.
- Manually raise canopy to full open position or hold control switch at "OPEN" position for electrical operation. See note and see caution.

TO CLOSE COCKPIT FROM OUTSIDE COCKPIT

- Open access door beneath left windshield and hold control switch at "CLOSE" position.
- Rotate handle 90° clockwise and push handle inboard (approximately 4 inches) to lock canopy. Rotate handle 90° counterclockwise and place in stowed position.

TO OPEN CANOPY FROM INSIDE COCKPIT

- Pull pilot's latch control handle to extreme aft position to unlock canopy.
- Manually raise canopy to full open position or hold pilot's canopy control switch at "OPEN" position for electrical operation. See note and see caution.

TO CLOSE CANOPY FROM INSIDE COCKPIT

- Hold pilot's canopy control switch at "CLOSE" position.
- Push pilot's latch control handle to forward position to lock canopy.

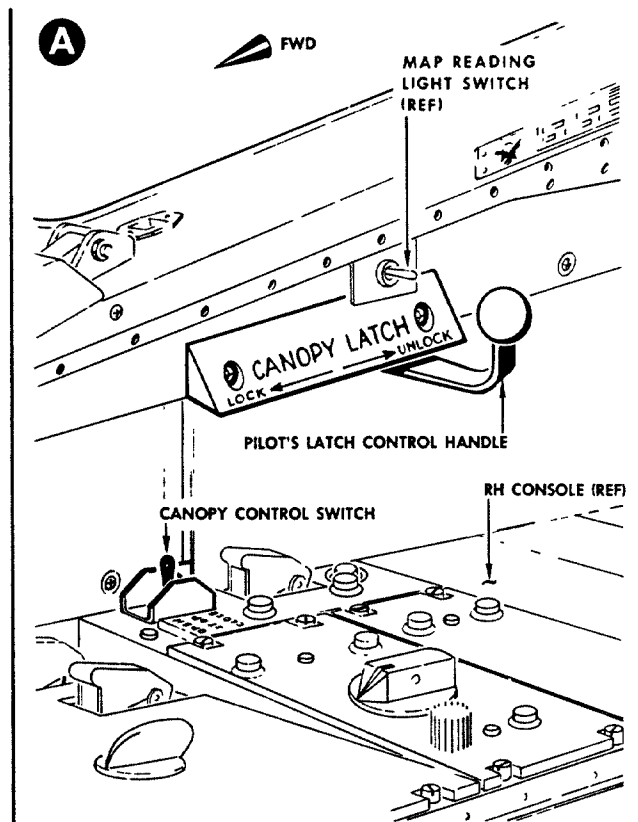

.06 02 5898 53 25 00

Figure 3-1. Canopy Actuating System Operation, F-106A

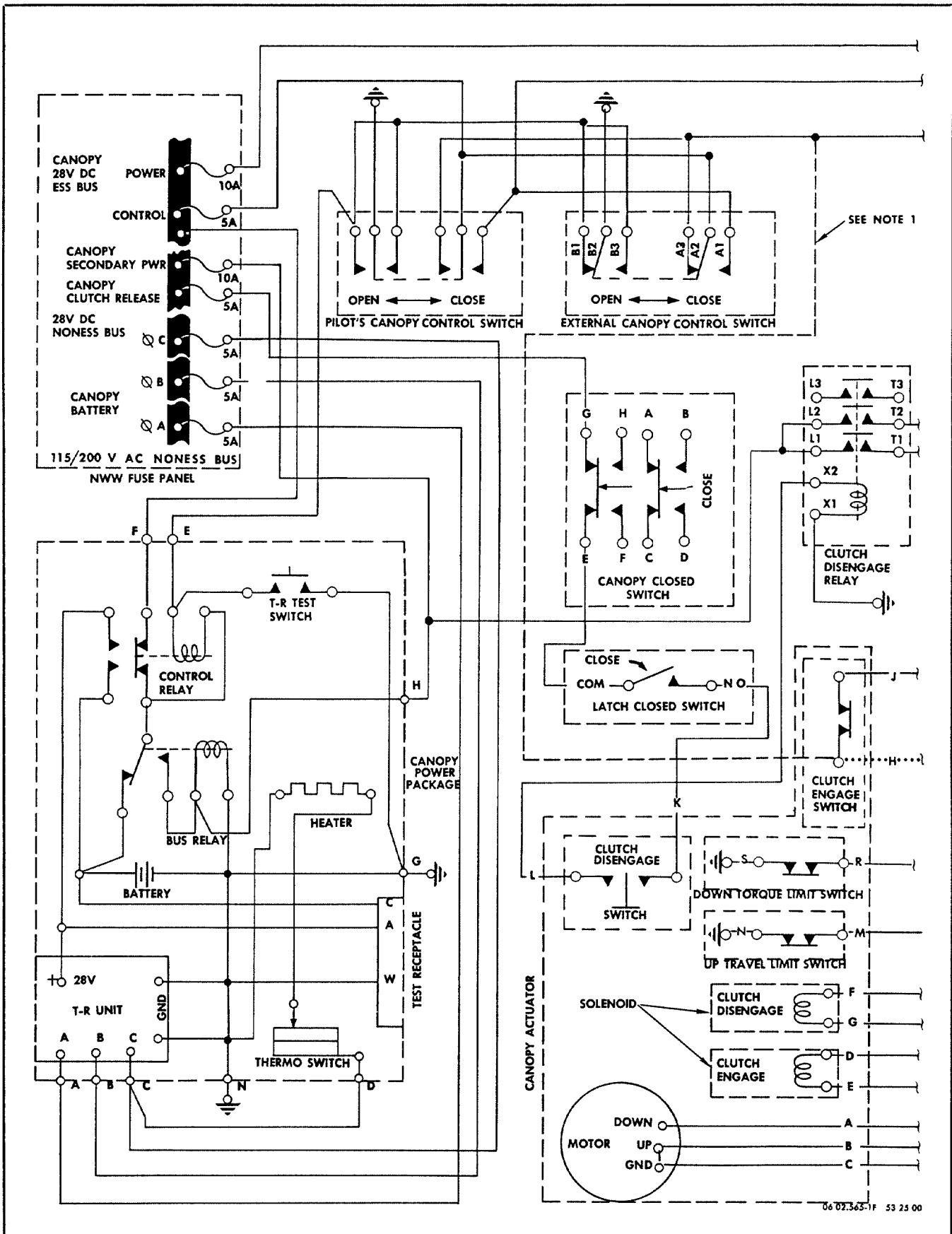

Figure 3-2. Canopy Actuating System Schematic, F-106A (Sheet 1 of 2)

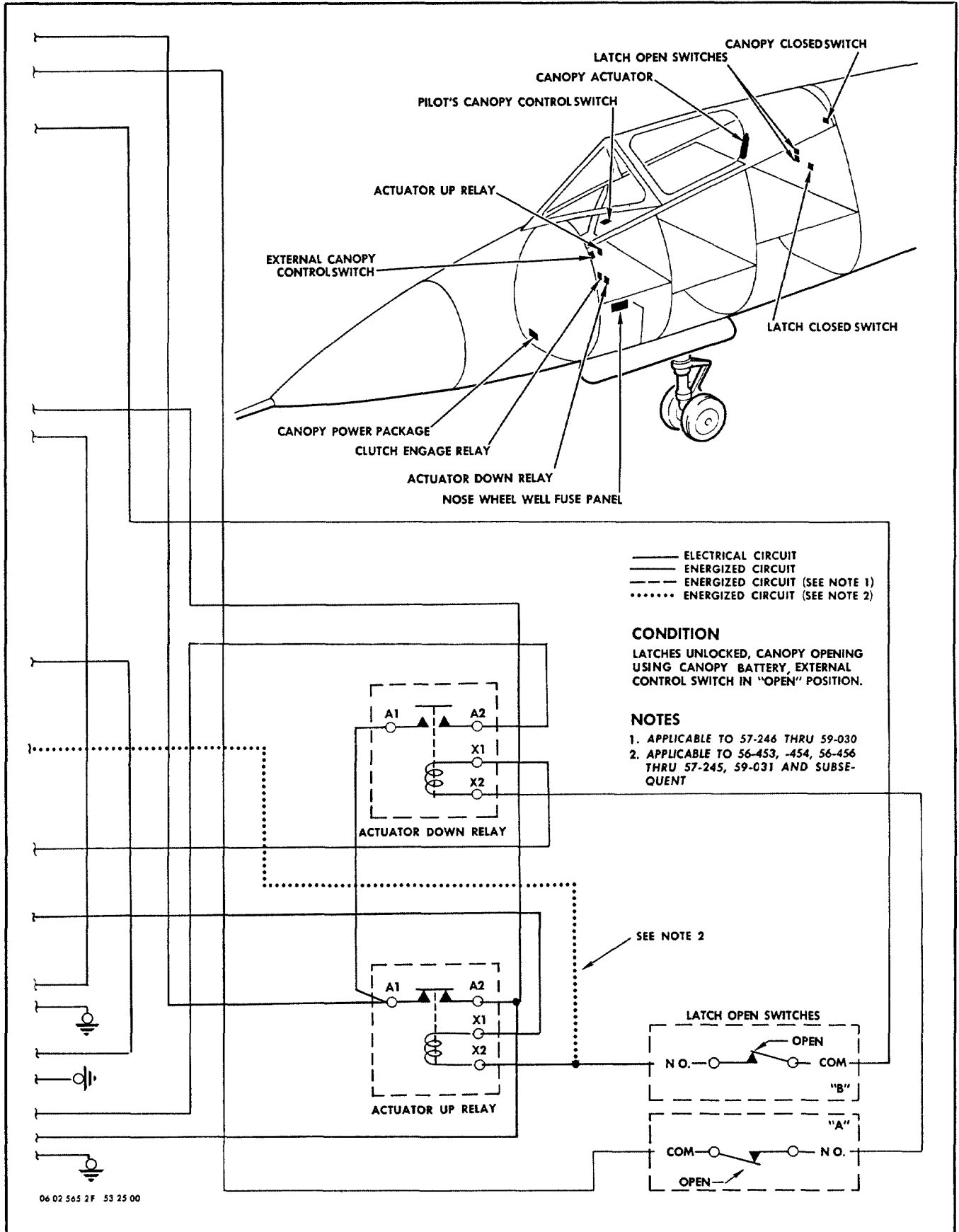
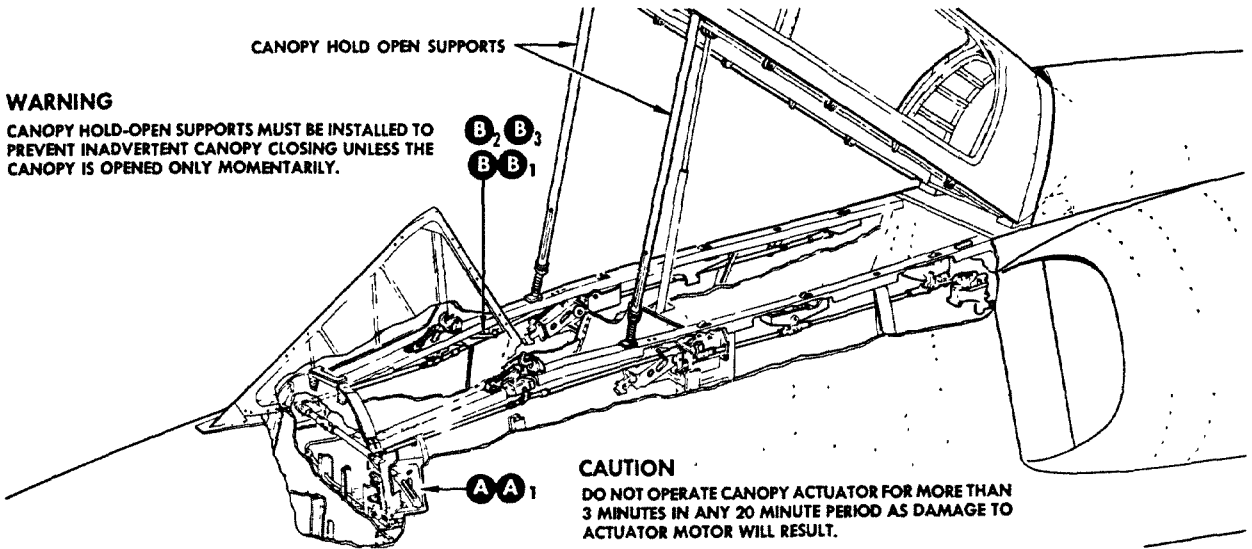

Figure 3-2. Canopy Actuating System Schematic, F-106A (Sheet 2 of 2)

WARNING

CANOPY HOLD-OPEN SUPPORTS MUST BE INSTALLED TO PREVENT INADVERTENT CANOPY CLOSING UNLESS THE CANOPY IS OPENED ONLY MOMENTARILY.

CANOPY HOLD OPEN SUPPORTS



CAUTION

DO NOT OPERATE CANOPY ACTUATOR FOR MORE THAN 3 MINUTES IN ANY 20 MINUTE PERIOD AS DAMAGE TO ACTUATOR MOTOR WILL RESULT.

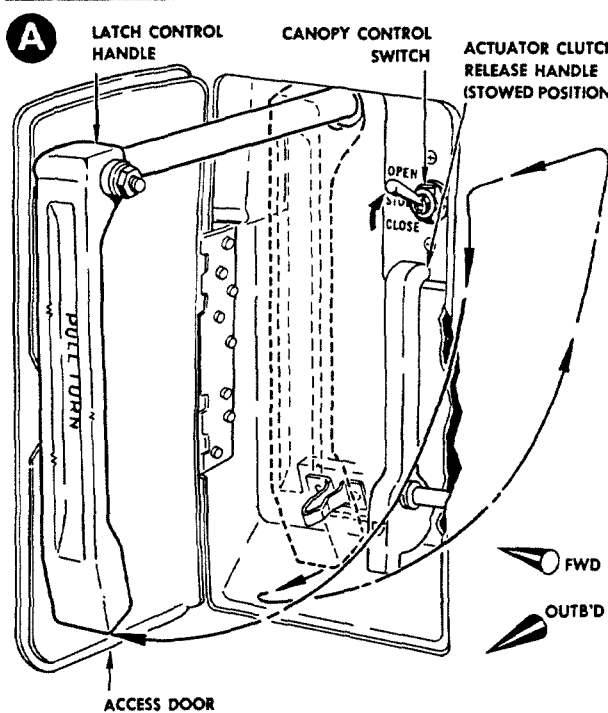

OPENING CANOPY FROM OUTSIDE COCKPIT

- a. Open access door below left windshield, pull latch control handle out, rotate handle 100° counterclockwise, pull handle out again, and then rotate handle 100° clockwise to unlock latches.
- b. Hold canopy control switch at "OPEN" position for electrical operation. Install canopy hold-open supports. For manual operation, pull actuator clutch release handle down to release clutch, hold handle in this position, raise canopy manually, place handle in stowed position to engage clutch and hold canopy open. Install canopy hold-open supports.

.06 02 1019 18

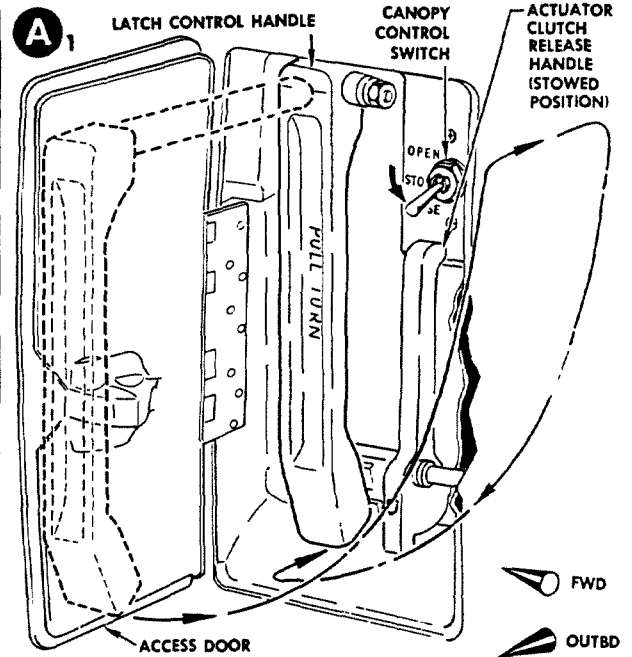

CLOSING CANOPY FROM OUTSIDE COCKPIT

- a. Remove canopy hold-open supports. Open access door below left windshield. Hold canopy control switch at "CLOSE" position until forward end of canopy reaches a point approximately 2 inches from full closed; release switch, wait until canopy movement stops, then reactuate switch and operate canopy to full closed position.

CAUTION

DO NOT OPERATE CANOPY TO FULL CLOSED POSITION WITHOUT STOPPING; DAMAGE TO ACTUATOR WILL RESULT.

- b. Pull latch control handle out then rotate handle 100° counterclockwise to lock latches. Push handle in 1 inch, rotate handle 100° clockwise, and place handle in stowed position. Close access door.

Figure 3-3. Canopy Actuating System Operation, F-106B (Sheet 1 of 2)

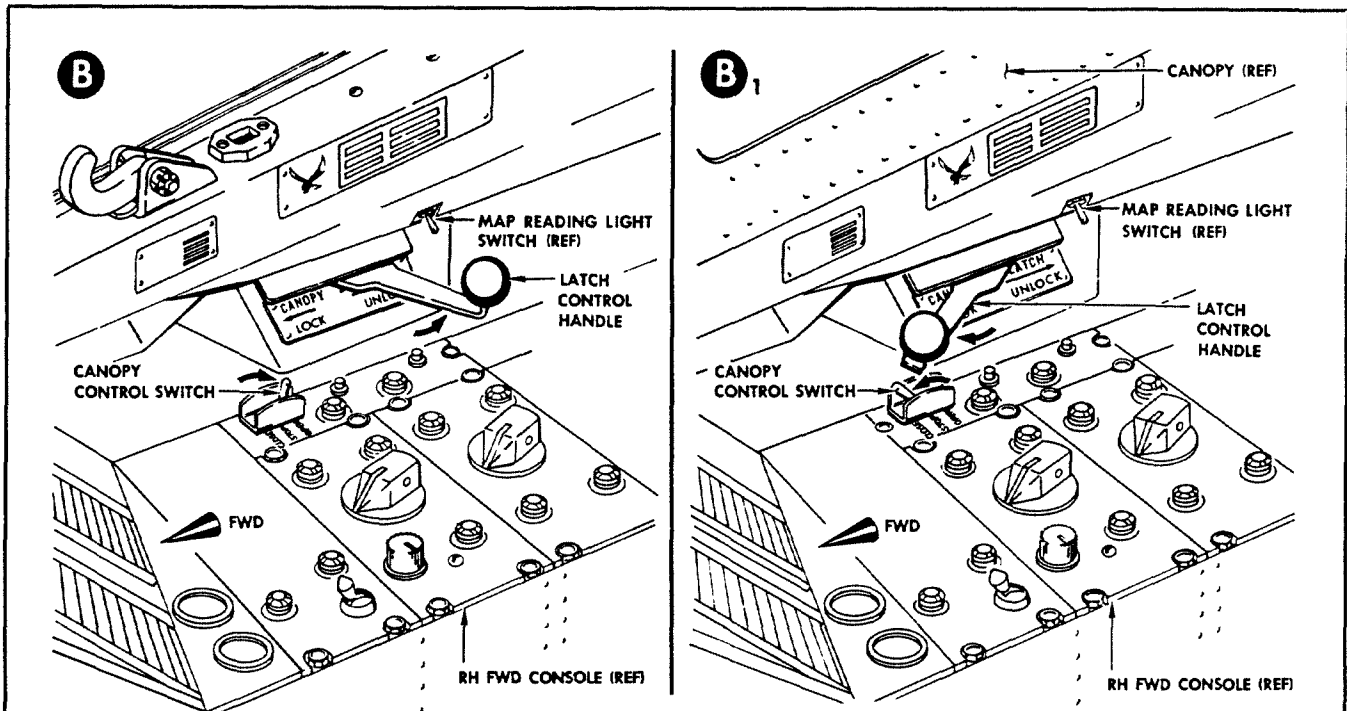

APPLICABLE TO 57-2508 THRU 57-2515, 57-2520 AND SUBSEQUENT.

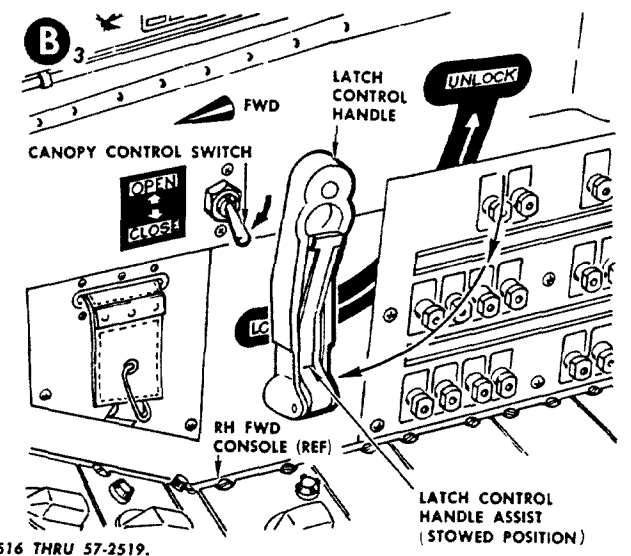
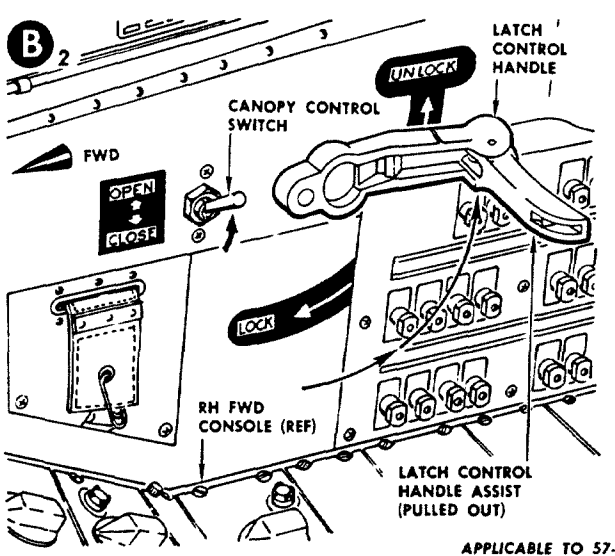

APPLICABLE TO 57-2516 THRU 57-2519.

OPENING CANOPY FROM INSIDE COCKPIT

- a. Operate latch control handle to "UNLOCK" position.
- b. Hold canopy control switch at "OPEN" position. Install canopy hold-open supports.

CLOSING CANOPY FROM INSIDE COCKPIT

- a. Remove canopy hold-open supports. Hold canopy control switch at "Close" position until forward end of canopy reaches a point approximately 2 inches from full closed position; release switch, wait until canopy movement stops, then reactuate switch and operate canopy to full closed position.

CAUTION

DO NOT OPERATE CANOPY TO FULL CLOSED POSITION WITHOUT STOPPING; DAMAGE TO ACTUATOR WILL RESULT.

- b. Operate latch control handle to "LOCK" position.

06 02 1019-28 53 25 00

Figure 3-3. Canopy Actuating System Operation, F-106B (Sheet 2 of 2)

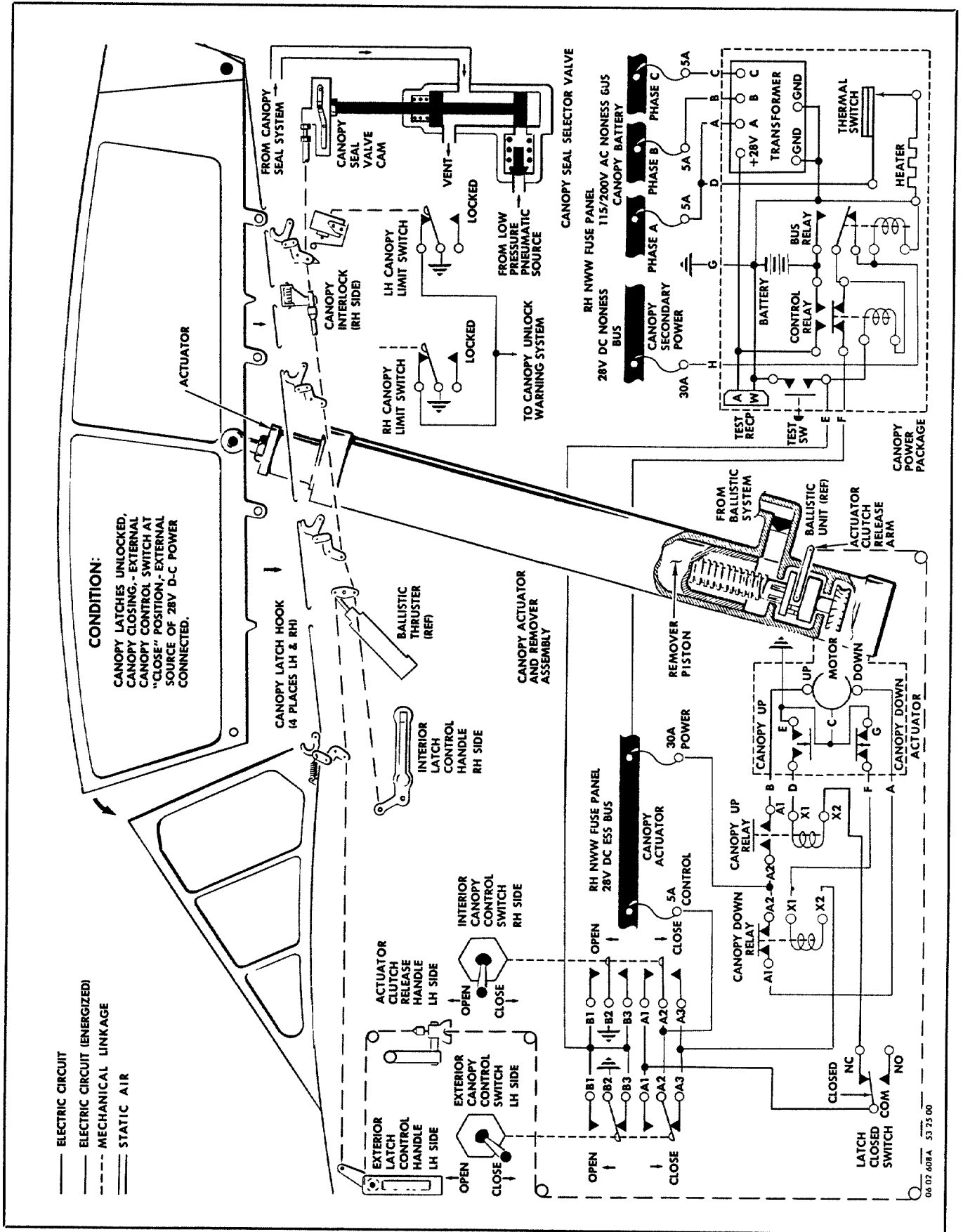
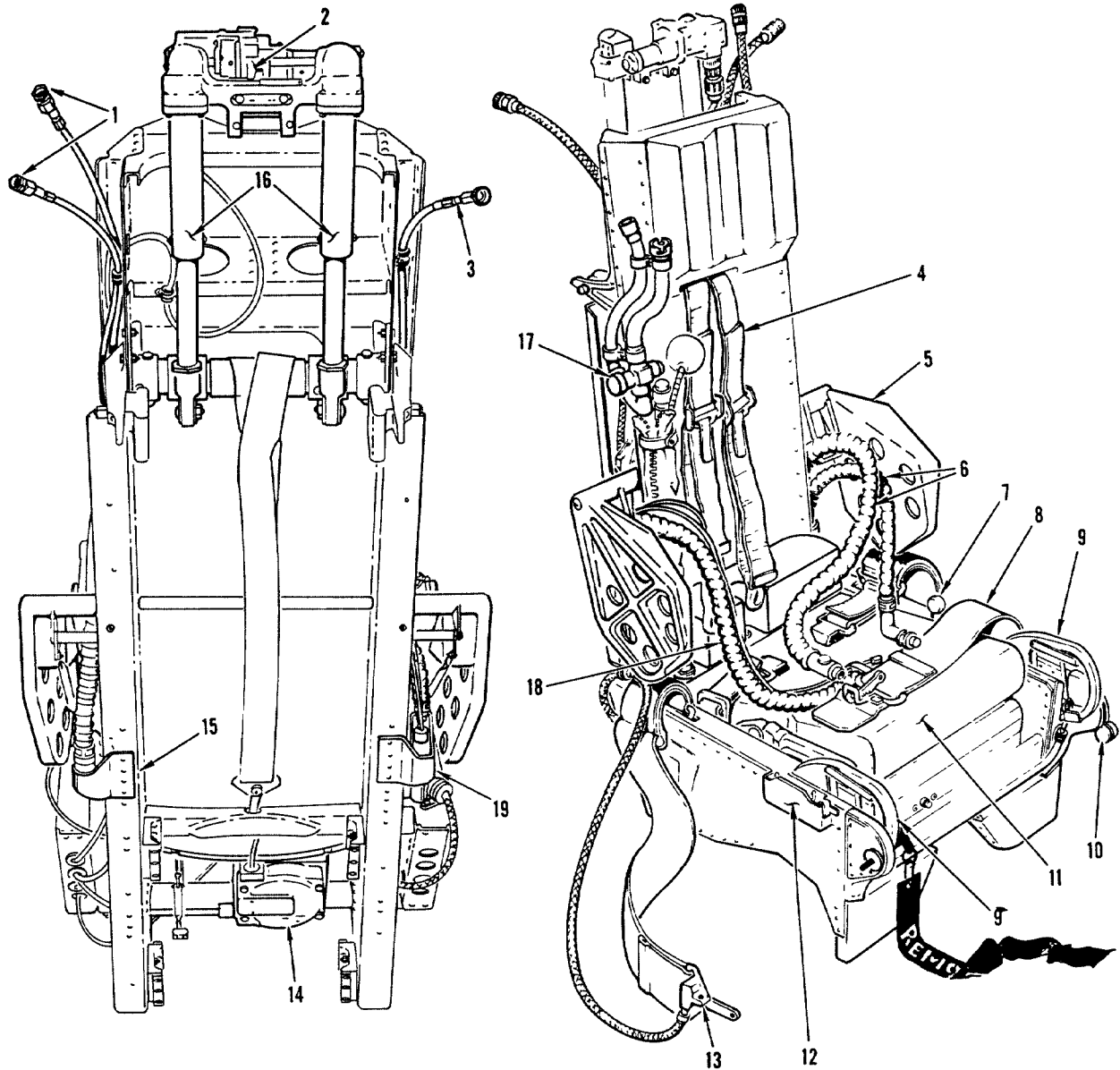

Figure 3-4. Canopy Actuating System Schematic, F-106B

**NOTE**

APPLICABLE TO F-106A AIRPLANES 57-2478 AND SUBSEQUENT; AND F-106B AIRPLANES 57-2527 AND SUBSEQUENT.

- | | |
|--|---|
| 1 BALLISTIC HOSES. | 11. SURVIVAL KIT |
| 2 SEAT ADJUSTING ACTUATOR. | 12. SEAT ADJUSTING SWITCH. |
| 3. BALLISTIC HOSE. | 13. LAP BELT AUTOMATIC RELEASE MECHANISM. |
| 4. SHOULDER HARNESS. | 14. INERTIA REEL. |
| 5. ARM GUARD (RAISED DURING EJECTION). | 15. LH QUICK-DISCONNECT ASSEMBLY (FOR PILOT'S ANTI-G AND VENT SUIT TUBING). |
| 6. ANTI-G SUIT AND VENT SUIT TUBING. | 16. SEAT ADJUSTING SCREW JACK. |
| 7. INERTIAL REEL LOCK. | 17. "KIT-TO-MAN" PERSONAL LEADS. |
| 8. LAP BELT. | 18. OXYGEN TUBE AND ELECTRICAL LEADS (SEE NOTE) |
| 9. CANOPY JETTISON AND SEAT EJECTION CONTROL HANDLE. | 19. QUICK-DISCONNECT ASSEMBLY FOR PILOT'S OXYGEN AND ELECTRICAL LEADS (SEE NOTE). |
| 10. CANOPY JETTISON CONTROL. | |

Figure 3-5. Upward Ejection Seat

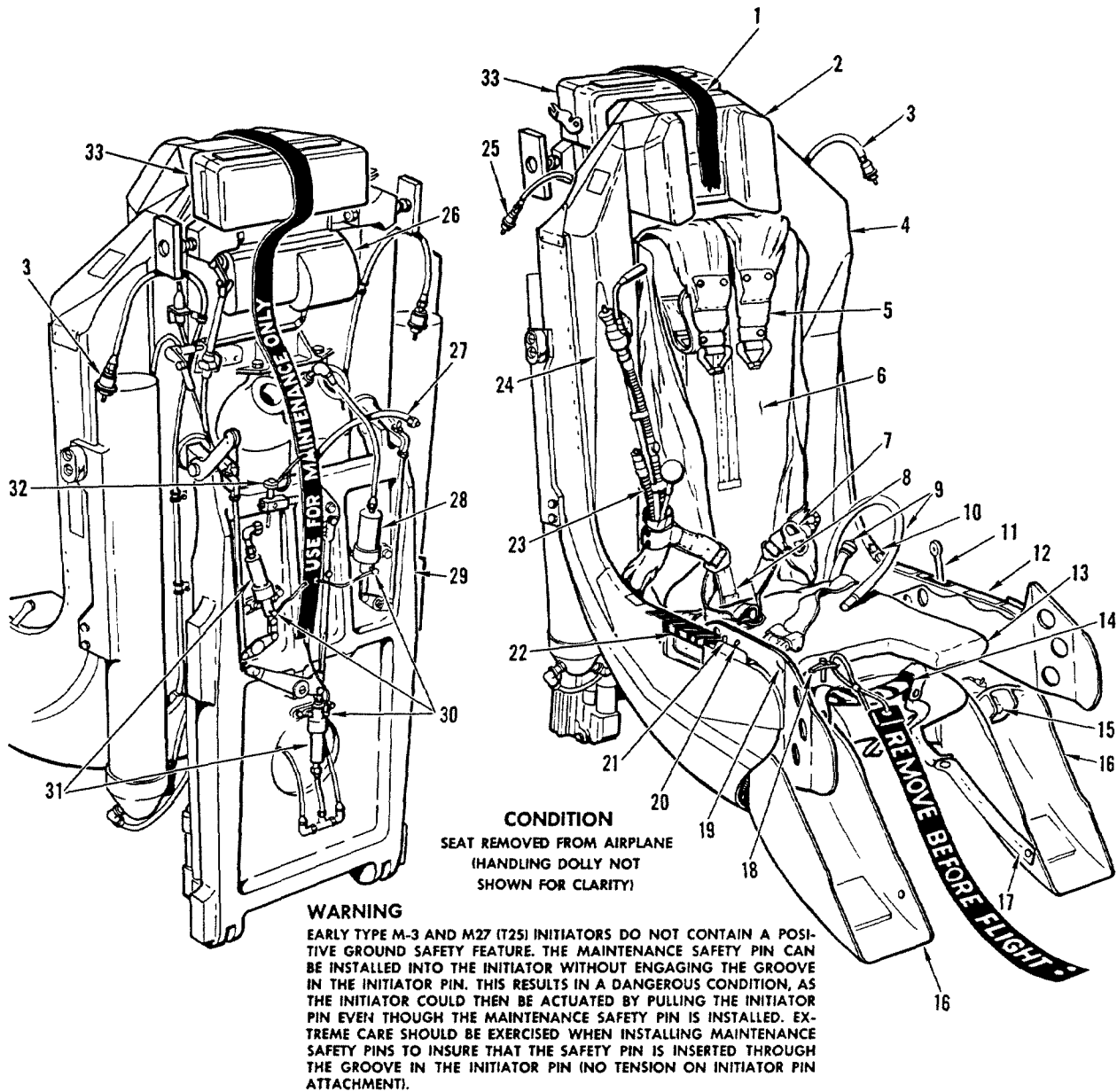

- | | |
|---|---|
| <ol style="list-style-type: none"> 1. WARNING STREAMER OF MAINTENANCE SAFETY PIN ASSEMBLY. 2. HEADREST. 3. BALLISTIC HOSE QUICK-DISCONNECT COUPLING (AFT SEAT OF F-106B AIRPLANES ONLY) 4. LEFT SURVIVAL PACK 5. SHOULDER HARNESS AND PARACHUTE ATTACHMENT STRAPS 6. PARACHUTE. 7. PARACHUTE D-RING. 8. LAP BELT. 9. ANTI-G AND VENT SUIT LEADS 10. THRUSTER OIL TEST LIGHT AND TEST SWITCH 11. INERTIA REEL CONTROL HANDLE. 12. CANOPY JETTISON ALTERNATE CONTROL HANDLE 13. SEAT PAD. 14. CANOPY JETTISON AND SEAT EJECTION CONTROL RING 15. FOOT RETRACTING CABLES. 16. FOOT PANS. | <ol style="list-style-type: none"> 17. FOOT PAN MANUAL RAISING LANYARD 18. PILOT'S GROUND SAFETY PIN 19. LEG GUARD. 20. RUDDER PEDAL ADJUSTMENT SWITCH. 21. SEAT ADJUSTMENT (VERTICAL) SWITCH. 22. EMERGENCY HARNESS RELEASE HANDLE 23. PERSONAL LEADS. 24. RIGHT SURVIVAL PACK 25. BALLISTIC HOSE QUICK-DISCONNECT COUPLING (ALL SEATS) 26. INERTIA REEL. 27. BALLISTIC HOSE (AFT SEAT OF F-106B AIRPLANES ONLY) 28. M-3A1 INITIATOR. 29. SEAT CARRIAGE 30. MAINTENANCE SAFETY PINS. 31. INITIATORS (M-27 OR M-3A1) 32. PIP TYPE MAINTENANCE SAFETY PIN 33. CHAFF DISPENSER |
|---|---|

06 02 1060E

Figure 3-6. Rotational Upward Ejection Seat

reel control handle. The shoulder harness straps are connected to the back type parachute and the inertia reel. The spring loaded inertia reel allows the pilot limited shoulder movement, but prevents him from being thrown forward in case of an accident. The inertia reel locks automatically when a rapid pull (equivalent to 2 or 3G deceleration) is exerted on the shoulder harness or during seat ejection. The seat's back type parachute, a survival pack located at each side of the parachute, the lap safety belt and the shoulder harness straps are provided with connectors which are connected to the pilot's USAF integrated harness. An electrical actuator, located on the bottom of the seat, provides the pilot with vertical seat adjustment. The actuator is controlled by the seat's vertical adjustment switch. The airplane's "G" and vent suit

system, electrical system, and the oxygen system are connected to the seat by quick-disconnect couplings. The seat contains an oxygen regulator and two emergency oxygen bottles. During normal flight, gaseous oxygen from the airplane's oxygen supply is routed to the regulator within the seat. The regulator provides 100% oxygen at a positive pressure and with continuous flow to the pilot at all altitudes. The emergency oxygen bottles are used if the airplane's system is exhausted or after seat ejection. The seat also contains numerous ballistic devices which are used in the pilot escape system. See figure 3-6 for an illustration of the rotational upward ejection seat. Refer to T.O. 1F-106A-2-2 for complete coverage of this system.

PILOT ESCAPE SYSTEM (UPWARD EJECTION)

3-9. GENERAL.

The canopy jettison and seat ejection systems provide the pilot with a means of emergency exit from the airplane during flight and while on the ground. A ballistic system which is completely independent of any of the airplane's power sources is employed to unlock and jettison the canopy and to eject the pilot and seat from the airplane. Controls for placing the system in operation are located on the seat. An exterior control is also provided to jettison the canopy from the airplane for emergency access to the cockpit from the ground. This control is located on the left side of the fuselage forward of the wing. A ground safety pin installed in the right ejection control handle of the seat will immobilize all controls on the seat, but operation of the canopy jettison system by means of the exterior control will still be possible.

WARNING

The safety pin in the right ejection control handle of the seats must not be removed until just prior to flight.

3-10. CANOPY JETTISON SYSTEM.

At the pilot's option (either pilot on F-106B airplanes), the canopy can be jettisoned without ejecting the pilot's seat. This is accomplished by squeezing and raising the split knob handle at the forward left side of the seat. After the canopy is jettisoned, the seat may be ejected by raising one of the two seat ejection control handles. The canopy may also be jettisoned in flight (forward pilot only on F-106B airplanes) by manually operating the canopy latch handle to the unlocked position. When the air loads jettison the canopy, the seat(s) are armed for ejection. Refer to T.O. 1F-106A-2-2 for complete coverage of this system.

3-11. CANOPY JETTISON AND SEAT EJECTION.

The canopy can be jettisoned and the seat ejected by raising one of two ejection control handles on the seat. Raising either handle will lock the shoulder harness, raise the arm guards, release the initiator safety lock for seat ejection and fire the canopy unlatch initiator. This action in turn fires the ballistic units to jettison the canopy and eject the seat. The upward movement of the seat disconnects the pilot's personal leads, ballistic hoses and fires a delay initiator to open the pilot's lap belt about one second after seat ejection. *Applicable to airplanes equipped with survival kit*, the upward seat movement will also disconnect the survival kit. When this is accomplished, the survival kit automatically furnishes the pilot with gaseous oxygen during bailout. A ground safety pin is installed in the right side of the seat(s) while the airplane is on the ground; the safety pin(s) prevent the accidental operation of the ejection system. Refer to T.O. 1F-106A-2-2 for complete coverage of this system.

3-12. CANOPY GROUND EMERGENCY OPERATION.

The canopy can be opened or jettisoned from outside the airplane during a ground emergency. Actuating the external release handle, located at the left side of the fuselage directly below the windshield, will unlock the canopy latches and permit manual raising of the canopy. See figures 3-1 or 3-3 for the procedure to open the canopy from the outside. In event the canopy cannot be raised manually, an emergency ground control handle can be used to jettison the canopy. This handle is located under a door on the left side of the fuselage directly forward of the wing. The canopy will jettison when the handle and attaching cable (approximately six feet) is pulled taut and then pulled outboard. When the canopy is jettisoned, the seat ejection system is armed.

WARNING

Rescue personnel must check that both ejection control handles on the seat (both seats *on F-106B airplanes*) are in "down" position before pulling out the emergency ground control handle. If ejection control handle is raised, seat ejection will occur after the canopy is jettisoned.

3-13. BAILOUT SEQUENCE WARNING SYSTEM, F-106B.

The bailout sequence warning system has two functions: to provide visual indication to both pilots when either pilot deems it necessary to eject; to provide visual indication to the pilot in the forward cockpit when the pilot in the aft cockpit has ejected. The system consists of a red bailout warning light on the forward and aft instrument panel, a bailout signal switch on the forward and aft left-hand consoles, a flasher unit, a "seat gone" switch located on the aft seat ejection rail and the necessary electrical circuitry. In event either bailout signal switch is placed to "ON" position, the bailout warning lights will flash on and off. When the aft seat is ejected, the "seat gone" switch will actuate and cause steady illumination of the bailout warning lights. This indicates to the pilot in the forward cockpit that the aft seat has ejected. The system receives 28-v dc power through a "BAILOUT WARN" fuse on the forward cockpit left-hand fuse panel. Refer to T.O. 1F-106A-2-9 for complete coverage of this system.

3-14. SURVIVAL KIT.

The survival kit is installed in place of the seat cushion. The kit consists of an interconnected, two-piece reinforced fiberglass container and a cushion that provides a seat pack for the pilot(s). The container is equipped with the following items:

- a. Oxygen system components for normal and emergency operations.
- b. Life raft and CO₂ bottle to inflate raft.
- c. Radio, radar and sun reflector.
- d. Rifle and fishing gear.
- e. Water purifier.
- f. Sleeping bag.
- g. Food.
- h. First aid kit and other items required for survival peculiar to the area in which the airplane is based.

A multipurpose quick-disconnect fitting on the bottom of the container connects the kit, through a hole in the seat, to the airplane's oxygen system, communication system, and helmet face plate defog system. Straps attached to the pilot's parachute harness are attached to each side of the kit. Refer to T.O. 1F-106A-2-2 for detailed descriptions of the normal and emergency operation of the survival kit. Refer to T.O. 1F-106A-2-6 for detailed information on the oxygen system.

PILOT ESCAPE SYSTEM (ROTATIONAL UPWARD EJECTION)

3-15. GENERAL.

The pilot escape system provides a means for jettisoning the canopy, ejecting the flight stable seat and pilot, actuating the chaff dispenser, furnishing the pilot with oxygen when he is above 15,000 feet altitude, separating the pilot and his gear from the seat at or below 15,000 feet, and deploying his parachute after separation from the seat. This system is of the ballistic (explosive) type and is completely independent of any airplane power. The system is operated mechanically by controls located on the pilot's seat. When the canopy jettison and seat ejection control ring (located on the forward edge of the seat) is operated, the canopy is jettisoned and the seat ejected. A canopy jettison (only) control handle is located on the left arm rest of the seat. When this control is operated, the canopy is jettisoned and the seat is armed, however, seat ejection and subsequent events will not occur until the seat ejection control ring is pulled. The canopy (only) can be jettisoned when the airplane is

ground borne by actuation of the external canopy jettison control handle. This handle is located at the left side of the fuselage near the leading edge of the wing and is used by ground personnel during an emergency. Refer to T.O. 1F-106A-2-2 for complete coverage of this system.

3-16. CANOPY JETTISON SYSTEM.

The canopy can be ballistically jettisoned (either pilot on F-106B) without ejecting the seat while the airplane is either airborne or on the ground. This is accomplished by depressing the canopy jettison control handle stowage lock, then pulling aft on the control handle located on the seat left arm rest. Non-ballistic airborne jettisoning of the canopy can be accomplished (forward pilot only F-106B) by manually operating the canopy latches to the unlocked position. The canopy lifts sufficiently for the airstream to catch and lift the canopy from the airplane. Refer to T.O. 1F-106A-2-2 for complete coverage of this system.

3-17. Canopy Jettison and Seat Ejection.

The pilot can jettison the canopy and eject the seat by pulling the canopy jettison and seat ejection control ring located on the forward edge of the seat. The initial pull on the control ring opens the seat AFCS switch which electrically disengages the AFCS and mechanically closes an electrical switch in the low speed ejection system.

NOTE

The electrical circuit of the low speed ejection system includes two switches; both switches must be closed to complete the circuit. One of these switches is pressure-actuated to the closed position by the airplane's pitot-static system at 280 (± 20) knots (IAS); the other switch is mechanically closed when the canopy jettison and seat ejection control ring is pulled. If ejection takes place at an airspeed lower than 280 (± 20) knots (IAS), the circuit will be completed. The completed circuit causes a ballistic cutter, in the headrest of the seat, to fire and cut the hesitation risers. This action causes the pilot's parachute to deploy without the 1.5 second delay period that is required for higher speed ejections.

The initial pull also mechanically fires an explosive cartridge. Gases from the cartridge cause the foot and seat pan actuator shaft and pulleys to rotate. This action mechanically actuates and locks the inertia reel, retracts the cables connected to the pilot's feet and raises the foot pans and leg guards. When the pilot's feet are both fully retracted, the ejection control ring mechanism safety locks are released. The initial pull on the control ring also fires the canopy unlatch initiator. High pressure gases from the initiator fires a cartridge in the canopy unlock thruster which extends and unlocks the canopy. This action in turn fires ballistic units to jettison the canopy and arm the seat. A continued pull on the canopy jettison and seat ejection control ring fires the ballistic units to disconnect the seat from the vertical adjustment actuator, and extends the vertical thruster which moves the seat and carriage upward on the seat rails. The upward movement of the seat disconnects the ballistic hoses and ship-to-seat personal leads. Separation of the personal leads automatically actuates the emergency oxygen system shutoff valve. This oxygen system furnishes the pilot and his partial pressure suit with oxygen until the pilot is separated from the seat. Continued upward movement of the seat actuates the chaff dispenser. The upward movement of the seat also releases the anti-rotation mechanism and fires an initiator to extend the rotational thruster piston, which rotates the seat to the launch position. Rotation of the seat will arm the drag chute ejector and fire the ballistic units to extend the telescopic flight stabilizer booms. Further rotation of the seat fires ballistic units to separate the seat from the seat carriage, and ignites the rocket motors. After separation, the rocket motors deliver a continuous upward and forward thrust until rocket burnout. As the seat leaves the airplane, the drag chute ejector mechanism is armed. If ejection takes place

above 15,000 feet altitude, the aneroid control of the drag chute ejector will not actuate until the pilot and seat have descended to 15,000 feet altitude. If the ejection takes place at 15,000 feet altitude or below, the aneroid control will actuate immediately. When the aneroid control actuates, ballistic units are fired to deploy the drag chute, disengage the lap belt, and to disconnect the shoulder straps and the personal leads. These actions free the pilot from all attachments to the seat except those of his feet. The pull of the drag chute releases the headrest container latch and separates it from the seat. As the headrest is separated from the seat, it mechanically fires a 1.5 second delay cartridge in each of the hesitation riser cutters.

NOTE

If ejection takes place under 280 (± 20) knots (IAS), the hesitation risers were previously cut, as described in the preceding note, and the force exerted by the drag chute is applied directly to a line. This force on the line deploys the pilot's parachute and fires an 0.8 second delay cartridge in the first stage line cutter. When the pilot's parachute deploys, the pilot and his lanyard-connected survival packs are pulled clear of the seat. After this is accomplished, the subsequent sequence of events is identical for both low and high speed ejections.

During this time delay period, the forces exerted by the drag chute on the hesitation risers pulls the pilot, his parachute, and his lanyard-connected survival packs clear of the seat. At this time the hesitation risers are cut, thus transferring the force exerted by the drag chute to a line which deploys the pilot's parachute. The parachute deployment line is cut; this separates the drag chute from the pilot's chute. The pilot descends with the lanyard-connected survival packs suspended below him. Refer to T.O. 1F-106A-2-2 for complete coverage of this system.

3-18. CANOPY GROUND EMERGENCY OPERATION.

For information on canopy ground emergency operations, refer to paragraph 3-12. Information contained in paragraph 3-12 is applicable to the canopy ground emergency operation for both pilot escape systems (upward ejection or rotational upward ejection).

WARNING

Rescue personnel must check that the pilot (*both pilots, F-106B airplanes*) has not pulled or is not holding the seat ejection control ring. *In aft cockpit of F-106B airplanes*, check that pilot's feet are not retracted. These checks must be made before pulling the emergency ground control handle. If either of these conditions exist, seat ejection will occur after the canopy is jettisoned.

3-19. BAILOUT WARNING SYSTEM, F-106B.

The bailout warning system provides either pilot with a means of signaling the other that bailout is imminent. The system is controlled by the manually operated bailout signal switches, one on each left console. When either switch is placed in the "ON" position, both bailout warning lights (one on each instrument panel) will flash. In this condition, 28-volt dc electrical power from the essential bus energizes the bailout warning flasher unit. Intermittent electrical power is then supplied to the warning lights. A 5-ampere "BAILOUT WARN" fuse on the cockpit left forward fuse panel protects the circuit. Refer to T. O. 1F-106A-2-9 for complete coverage of this system.

3-20. SURVIVAL PACKS (ROTATIONAL UPWARD EJECTION SEAT).

Two triangular shaped fiberglass constructed survival packs are installed in the seat, one on each side of the

back type parachute. Each pack is connected to the pilot's parachute container. The right pack is designed to contain a life raft and a CO₂ bottle for life raft inflation. The left pack may contain survival items such as a radio, radar and sun reflector, sleeping bag, rifle, fishing tackle, water purifier and first aid kit.

NOTE

Survival items contained within the survival packs may vary according to the area in which the airplane is based.

The survival packs are normally connected and/or disconnected manually by the pilot to his harness. During an emergency such as a crash, over the side bailout, or after ejection, both packs may be released mechanically by operating the emergency harness release handle. Refer to T. O. 1F-106A-2-2 for complete coverage of the survival packs.

EMERGENCY ARRESTING SYSTEM

3-21. GENERAL.

The emergency arresting system is used after the normal arresting devices such as speed brakes, drag chute, and wheel brakes have failed to stop the airplane. The system consists of a spring steel tail hook assembly, the tail hook latch assembly, an electrically operated solenoid and an electrical push button type switch. The forward end of the tail hook assembly is connected to the bottom center line of the fuselage at station 520.0. The solenoid is installed within the engine compartment and is mechanically linked to the tail hook latch assembly which holds the tail hook in the retracted position. The push button switch is located on the left side of the pilots' instrument panel(s). See figure 3-7 for a schematic illustration of

this system. The tail hook is extended by depressing the "TAIL HOOK DOWN" switch. When the switch is depressed, 28-volt dc power from the airplane's battery bus flows through the "TAIL HOOK RELEASE" fuse of the nose wheel well right-hand fuse panel to the solenoid. The solenoid is energized, the tail hook latching assembly is unlatched and the tail hook extends due to spring action. The tail hook wear plate is held against the surface of the runway by spring action to permit engagement with arresting cables stretched across the runway. An energy absorbing device attached to each end of the cable provides the cushioned force required to stop the airplane. Refer to T. O. 1F-106A-2-2 for detailed information on the emergency arresting system.

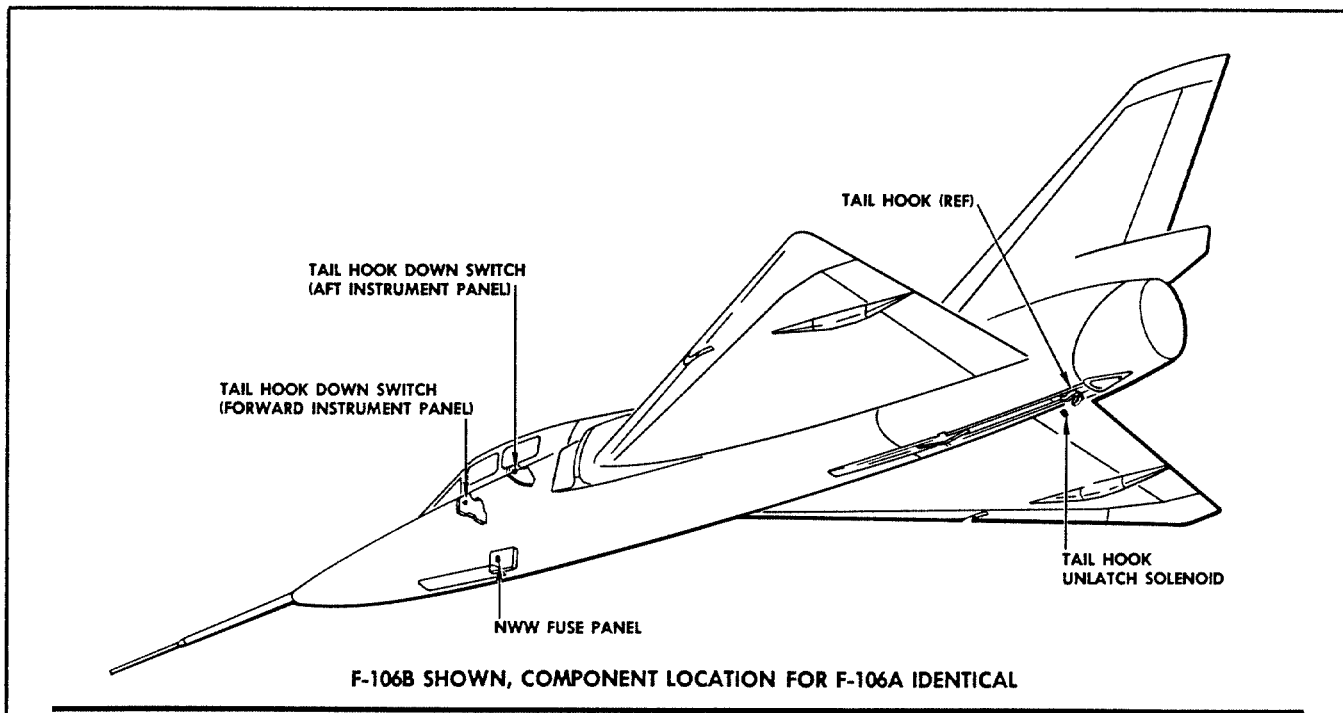

TAIL HOOK RELEASE

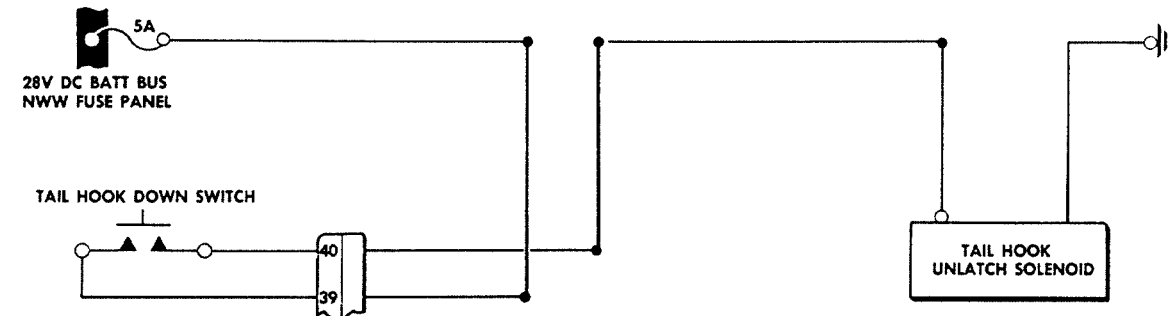

APPLICABLE TO 56-453, -454, 56-456 THRU 57-245, 59-001 AND SUBSEQUENT, AND 57-246 THRU 58-798 AFTER INCORPORATION OF TCTO 1F-106-579.

F-106A

TAIL HOOK RELEASE

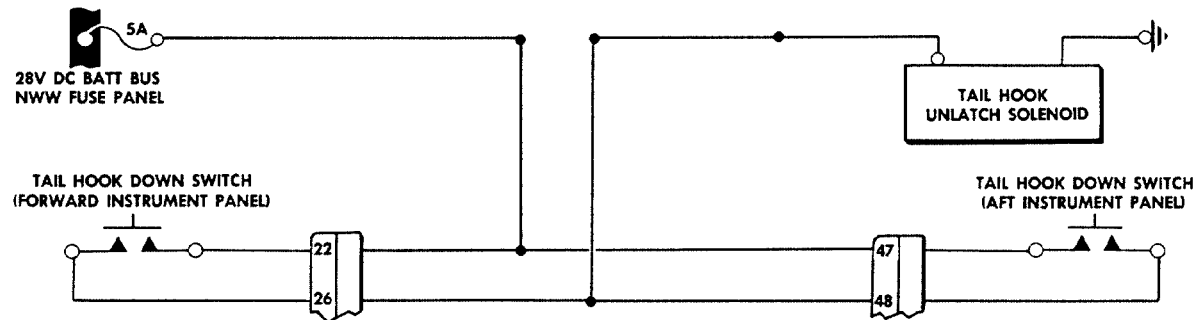

APPLICABLE TO 57-2508 THRU -2515, 57-2542 AND SUBSEQUENT; AND 57-2516 THRU 57-2541 AFTER INCORPORATION OF TCTO 1F-106-579.

F-106B

Figure 3-7. Emergency Arresting System, Schematic

Section IV

HYDRAULIC AND PNEUMATIC POWER SYSTEMS

<i>Contents</i>	<i>Page</i>
Hydraulic Power Systems	4-1
Hydraulic Sub-Systems	4-1
High Pressure Pneumatic Supply System	4-6
High Pressure Pneumatic Sub-Systems	4-9
Low Pressure Pneumatic Supply System	4-11
Low Pressure Pneumatic Sub-Systems	4-11

HYDRAULIC POWER SYSTEMS

4-1. GENERAL.

The hydraulic power systems consist of the primary, secondary, and emergency systems. The primary system develops and furnishes hydraulic power used to operate the flight control surfaces. The secondary system furnishes power to the control surfaces in conjunction with the primary system, and provides the only source of hydraulic power for operation of the landing gear, nose wheel steering, speed brakes, emergency ac generator, and the variable inlet ramp. Each system has an independent hydraulic pressure indicator and a common low pressure warning light in the cockpit. The light will illuminate and flash in event the hydraulic pressure in either system drops below 900 (± 100) psi. In event the hydraulic pressure in both systems drops below 900 (± 100) psi, the warning light will illuminate and remain steady. A thermostatic switch, installed in each hydraulic system, will actuate a cockpit warning light which provides the pilot with a visual indication of hydraulic oil overtemperatures. The red "HYD OIL HOT" warning

light will illuminate when the temperature in either system reaches $135^{\circ} + 5.55^{\circ}$, -2.8°C ($275^{\circ} + 10^{\circ}$, -5°F). Refer to T.O. 1F-106A-2-9 for complete coverage of the hydraulic oil hot warning system. The emergency system develops hydraulic power by means of a hydraulic pump driven by a ram air turbine extended into the slipstream. This system is used in flight if the engine becomes inoperative or a malfunction of the primary hydraulic pump occurs. See figures 4-1 and 4-2 for schematic illustrations of the hydraulic power system. T.O. 1F-106A-2-3 contains specific information pertaining to the F-106A and F-106B hydraulic systems.

NOTE

"Power Systems" are those portions of the hydraulic systems which provide filtered, pressure-regulated fluid: the reservoirs, pumps, filters, accumulators, and main relief valves. These components are included in both the primary and secondary hydraulic systems.

HYDRAULIC SUB-SYSTEMS

4-2. GENERAL.

The hydraulic sub-systems consist of the landing gear hydraulic system, the flight controls hydraulic system, the nose wheel steering hydraulic system, the speed brake hydraulic system, the emergency ac generator hydraulic system, and the variable ramp hydraulic system. These sub-systems use hydraulic power supplied by the hydraulic power systems discussed in paragraph 4-1. For descriptions of each hydraulic sub-system, refer to the following:

a. Landing Gear Hydraulic System.

1. Brief description in paragraph 9-3.

2. Complete coverage in T.O. 1F-106A-2-8.

b. Flight Controls and Speed Brake Hydraulic System.

1. Brief description in paragraphs 8-5 and 8-22.
2. Complete coverage in T.O. 1F-106A-2-7.

c. Emergency AC Generator Hydraulic System.

1. Brief description in paragraph 11-7.
2. Complete coverage in T.O. 1F-106A-2-10.

d. Variable Ramp Hydraulic System.

1. Brief description in paragraph 5-7.
2. Complete coverage in T.O. 1F-106A-2-4.

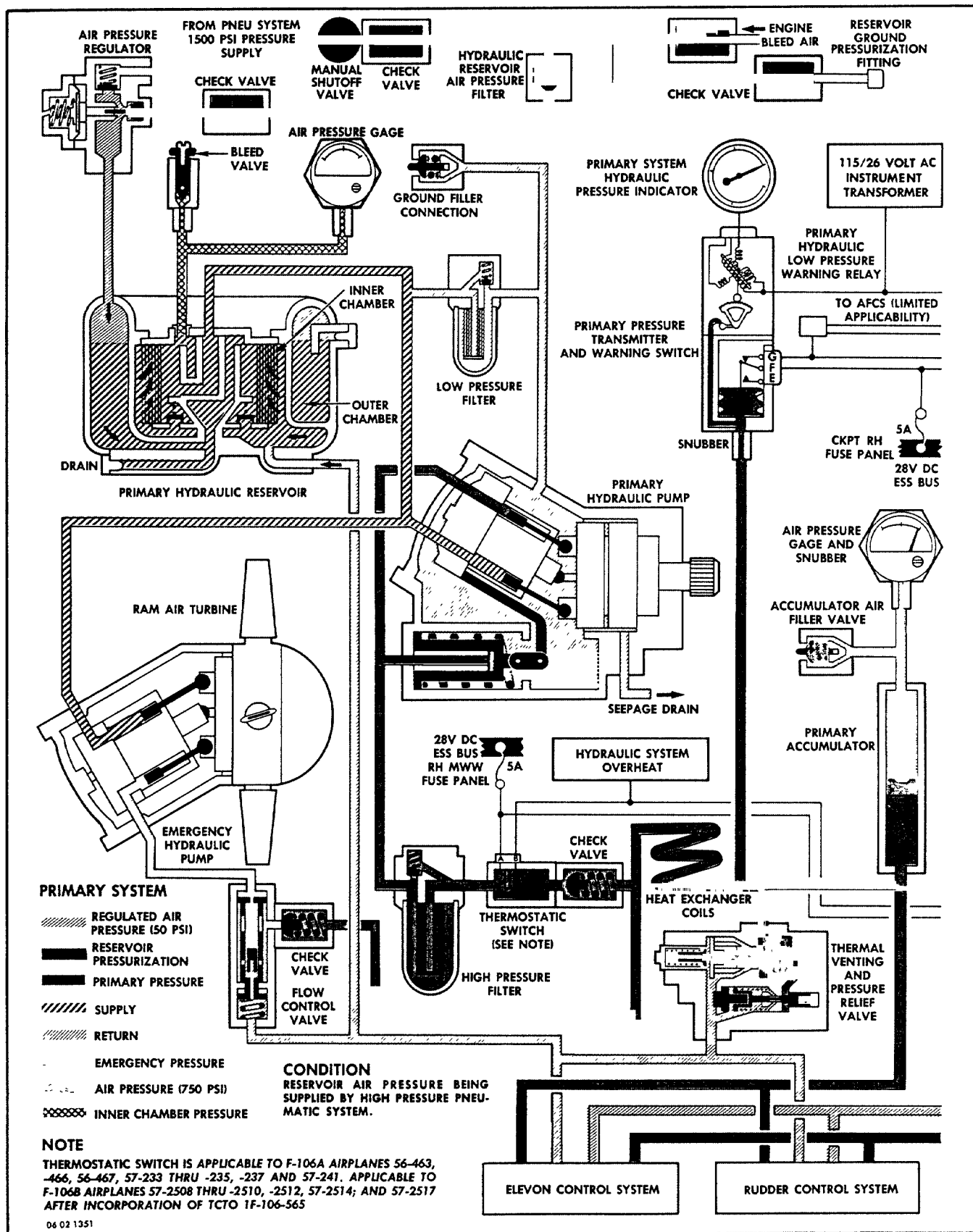
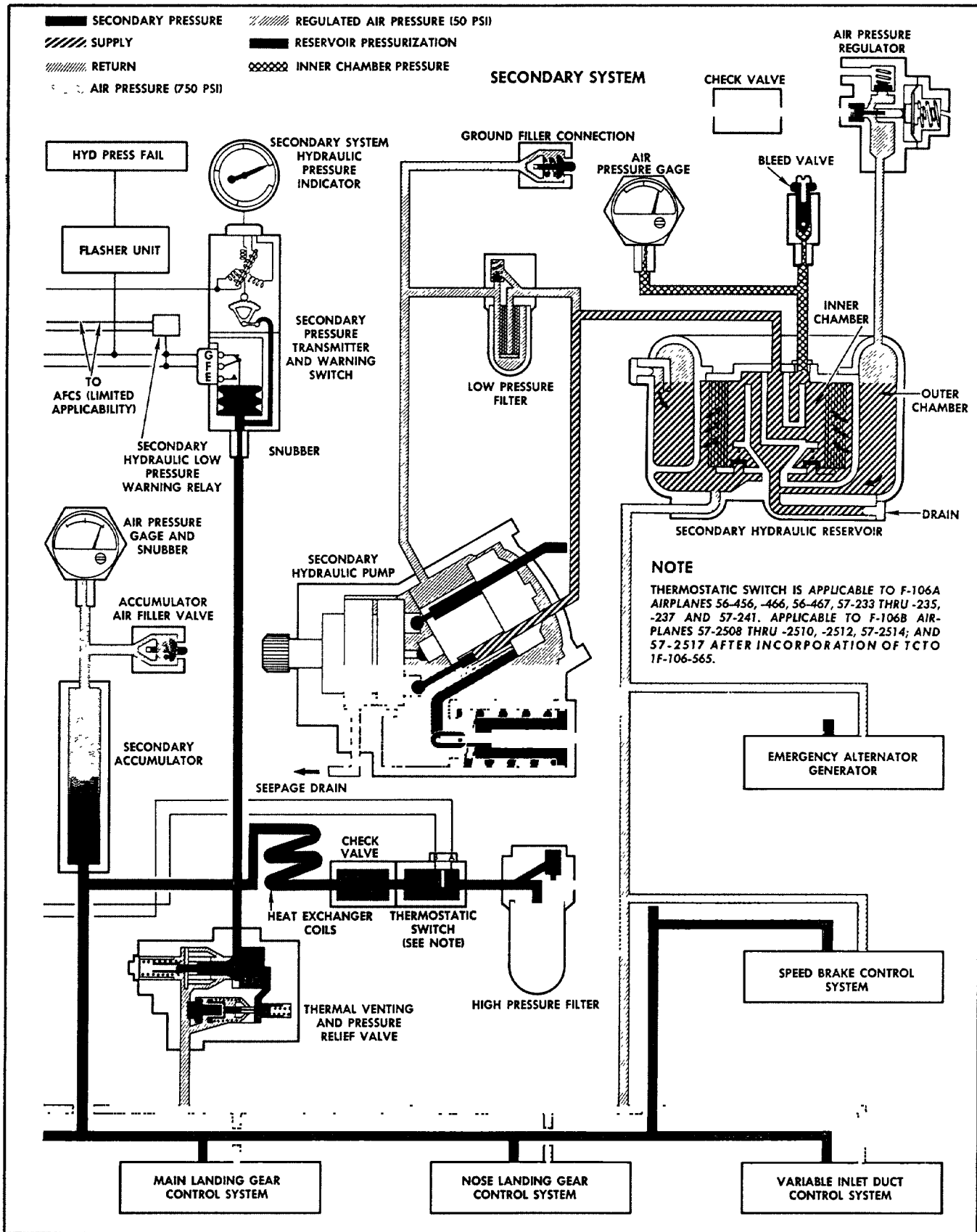

Figure 4-1. Hydraulic Power Supply System (Sheet 1 of 2)

Applicable to F-106A airplanes 56-463, -466, 56-467, 57-233 thru 57-235, 57-237, 57-241, and F-106B airplanes 57-2508 thru 57-2510, -2512, -2514 and 57-2517; and all other airplanes after incorporation of TCTO 1F-106-631.



06 02 1352

Figure 4-1. Hydraulic Power Supply System (Sheet 2 of 2)
 Applicable to F-106A airplanes 56-463, -466, 56-467, 57-233 thru 57-235, 57-237, 57-241, and F-106B airplanes 57-2508 thru 57-2510, -2512, -2514 and 57-2517; and all other airplanes after incorporation of TCTO 1F-106-631.

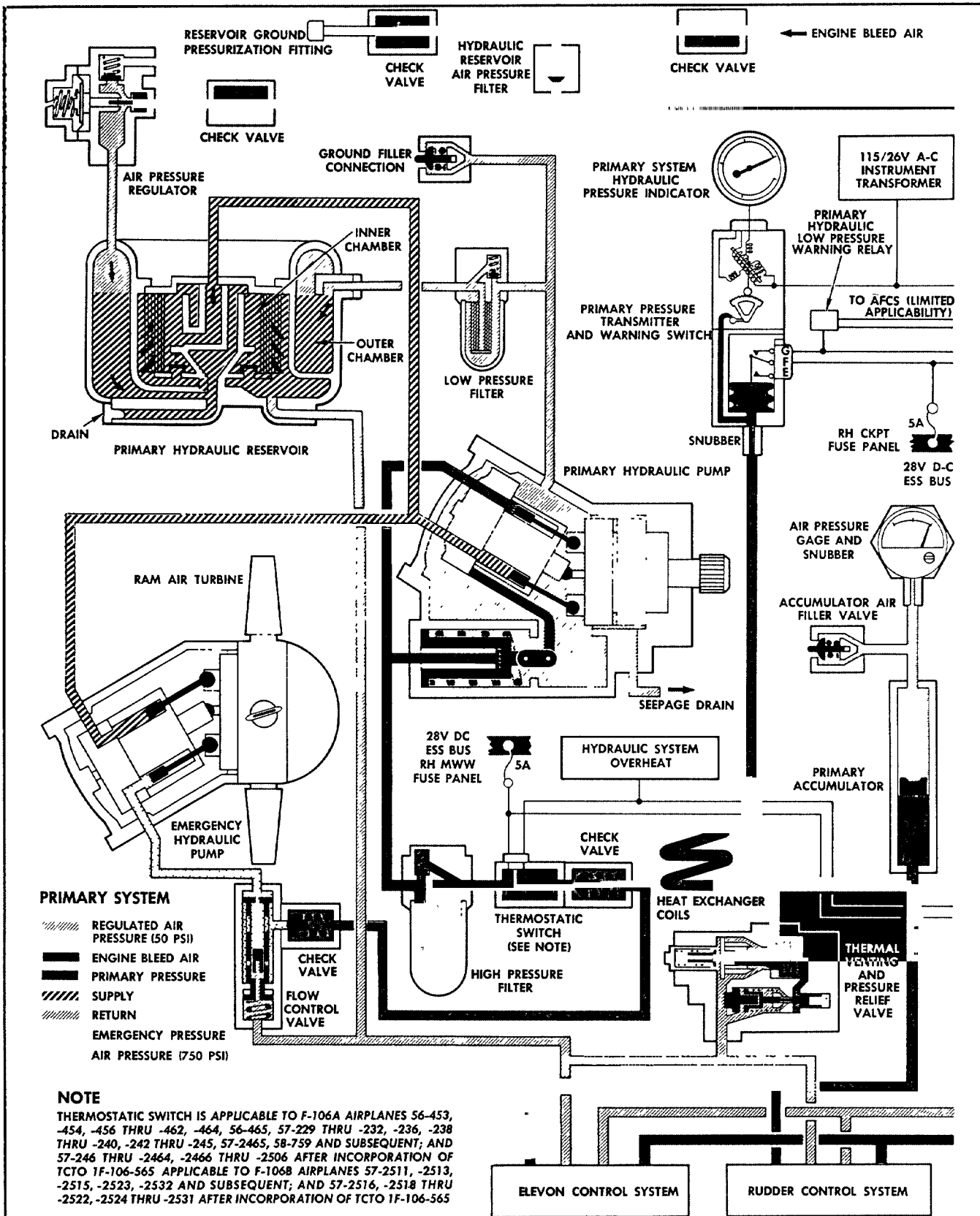

.06 02 019-1G 29 00.00

Figure 4-2. Hydraulic Power Supply Systems (Sheet 1 of 2)

Applicable to F-106A airplanes 56-453, -454, -456 thru -462, -464, 56-465, 57-229 thru -232, -236, -238 thru -240, 57-242 and subsequent, and F-106B airplanes 57-2511, -2513, -2515, -2516, 57-2518 and subsequent prior to incorporation of TCTO 1F-106-631.

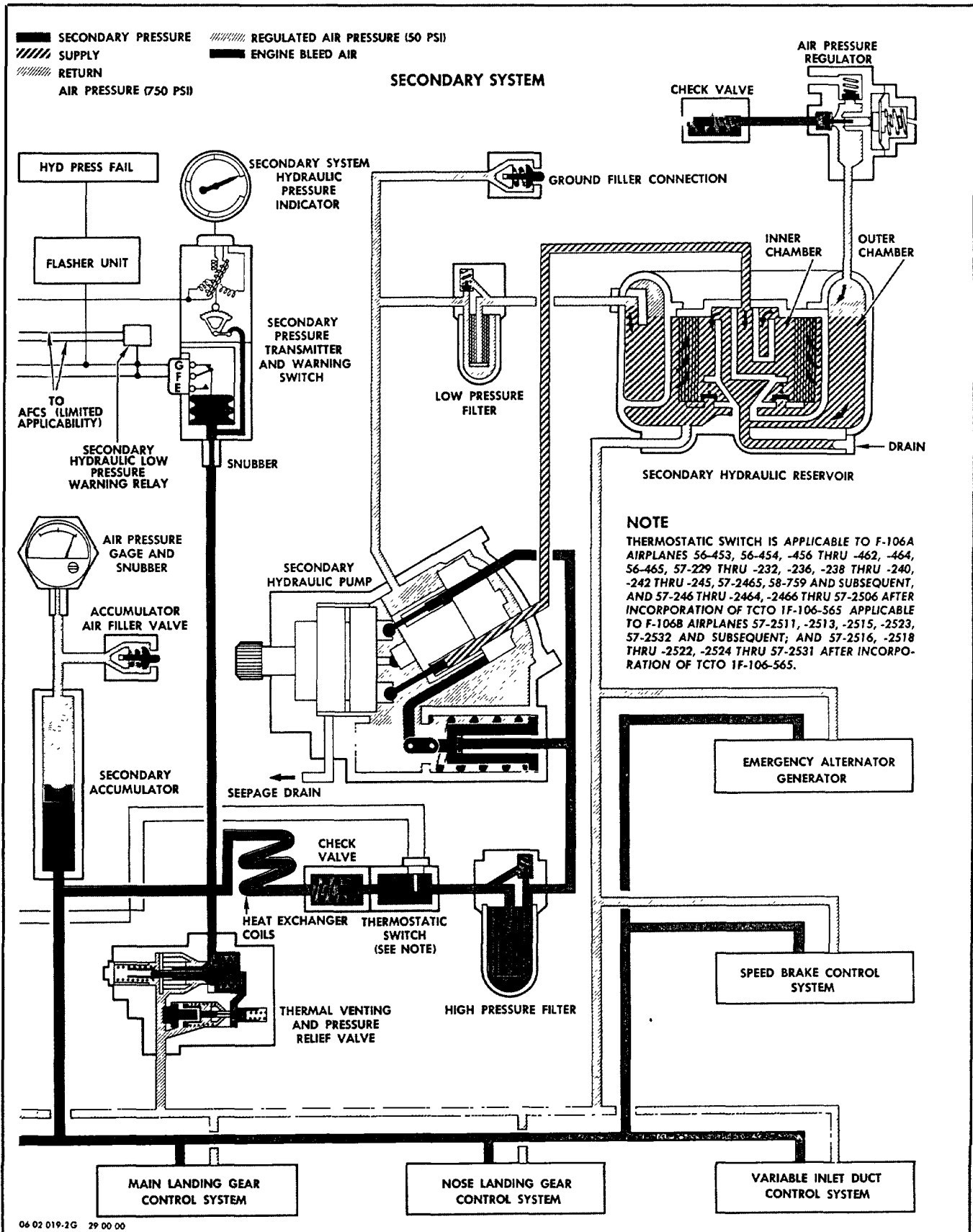

Figure 4-2. Hydraulic Power Supply Systems (Sheet 2 of 2)
 Applicable to F-106A airplanes 56-453, -454, -456 thru -462, -464, 56-465, 57-229 thru -232, -236, -238 thru -240, 57-242 and subsequent, and F-106B airplanes 57-2511, -2513, -2515, -2516, 57-2518 and subsequent prior to incorporation of TCTO 1F-106-631.

HIGH PRESSURE PNEUMATIC SUPPLY SYSTEM

4-3. GENERAL.

High pressure air is used to operate various sub-systems. Ground connections are provided for recharging the high pressure system. However, no provisions are made for recharging the system while the airplane is airborne.

WARNING

Operation of the equipment of this system involves the use of extremely dangerous high air pressures. Make sure that all pressure has been relieved from equipment or tubing before removing or disconnecting components.

The high pressure pneumatic system is divided into four supply systems, as follows: main system, main landing gear brake system, variable ramp emergency retraction system and the 3000 psi reserve system. The main supply system provides air pressure to operate several sub-systems. Air pressure for the main system is stored in two large fiberglass flasks and two landing gear drag brace accumulators. The air flasks are located in the air conditioning compartment; the drag brace accumulators are located on the forward side of the main landing gear. Air pressure is stored at 3000 psi, and is routed to the sub-systems through an air pressure regulator. The regulator furnishes two outlet pressures, 3000 psi and 1500 psi, to applicable sub-systems. The combined capacity of the large fiberglass flasks is 5100 cubic inches. Capacity of each drag brace accumulator is 100 cubic inches. A pressure gage is located in the main wheel well to indicate air pressure in the main system. A warning light is located on the warning indication panel. This light illuminates when system pressure drops below 1700 (± 50) psi. Following is a list of sub-systems that receive air pressure from the main supply system under normal operating conditions.

- a. Missile bay doors and missile launching system (1500 psi).
- b. Hydraulic reservoir pressurization (1500 psi). *Applicable to airplanes equipped with a reservoir servicing panel.*
- c. Emergency cg fuel transfer system (1500 psi).
- d. Rudder artificial feel system (1500 psi).
- e. Emergency control of the constant speed air-oil cooler valve (1500 psi).
- f. Cockpit emergency pressurization (1500 psi).
- g. Drag chute release system (3000 psi).
- h. Speed brake emergency extension system (3000 psi).
- i. Combustion starter system (3000 psi).

- j. Ram air turbine extension system (3000 psi).
- k. Landing gear emergency extension system (3000 psi).
- l. Variable ramp emergency retraction system (3000 psi).

4-4. The main landing gear brake supply system uses air pressure stored in two drag brace accumulators, located on the aft side of each main landing gear. Air pressure in the accumulators is supplied and maintained by the main pneumatic system. If air pressure in the main system should become exhausted, a check valve installed in the inlet port of each drag brace accumulator will isolate sufficient pressure in the drag brace accumulators for braking the airplane. A relief valve installed in the tubing on the outlet side of each drag brace accumulator prevents over pressurization. Each accumulator supplies 3000 psi air pressure to the adjacent brake only. Air pressure for the variable ramp emergency retraction system is stored in a small fiberglass flask. Variable ramp air pressure is isolated from the main supply system by a check valve. Capacity of the container is 100 cubic inches at 3000 psi. The container is located in the air conditioning compartment.

4-5. The 3000 psi reserve system pressure is contained in the two forward drag brace accumulators. Under normal conditions the accumulators supply pressure in conjunction with the main system storage flask for operation of the 3000 psi sub-systems. The forward drag brace accumulators act as a reserve system only when air pressure in the main system storage flask becomes exhausted due to a leak or by extended operation of the 1500 psi subsystems. Under this condition the cockpit low-pressure warning light will illuminate, although sufficient pressure is still available for operation of the following subsystems: drag chute release, speed brake emergency extension, ram air turbine extension, and landing gear emergency extension. This reserve pressure is isolated in the forward drag brace accumulators by a single check valve installed in the tubing between the accumulators and the main system storage flask.

4-6. The main storage flasks, drag brace accumulators, and the variable ramp system flask are charged through a single ground filler connection in the left main wheel well. The air in the main storage flasks and the forward drag brace accumulators may be completely bled by opening a bleed valve in the forward bulkhead of the left main wheel well. Refer to T.O. 1F-106A-2-3 for the procedure for bleeding the air pressure remaining in the aft drag brace accumulators. Refer to T.O. 1F-106A-2-3 for the procedure for bleeding the air from the variable ramp system flask. The high pressure pneumatic system is shown on figures 4-3 and 4-4 and is discussed in detail on T.O. 1F-106A-2-3.

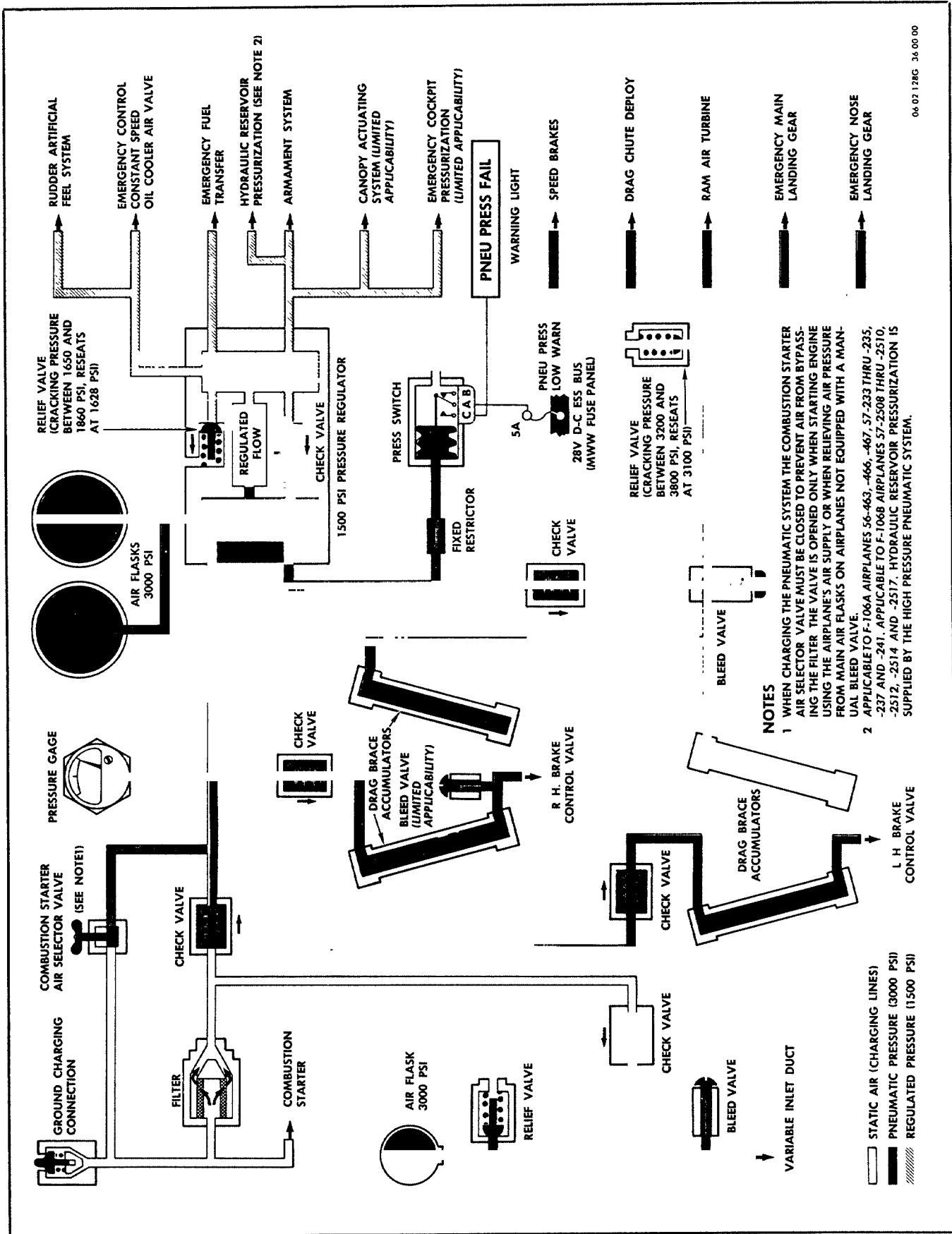

NOTES

- 1 WHEN CHARGING THE PNEUMATIC SYSTEM THE COMBUSTION STARTER AIR SELECTOR VALVE MUST BE CLOSED TO PREVENT AIR FROM BYPASSING THE FILTER. THE VALVE IS OPENED ONLY WHEN STARTING ENGINE USING THE AIRPLANE'S AIR SUPPLY OR WHEN RELIEVING AIR PRESSURE FROM MAIN AIR FLASKS ON AIRPLANES NOT EQUIPPED WITH A MANUAL BLEED VALVE.
- 2 APPLICABLE TO F-106A AIRPLANES 56-463, -466, -467, -57-233 THRU -235, -237 AND -241. APPLICABLE TO F-106B AIRPLANES 57-2508 THRU -2510, -2512, -2514 AND -2517. HYDRAULIC RESERVOIR PRESSURIZATION IS SUPPLIED BY THE HIGH PRESSURE PNEUMATIC SYSTEM.

Figure 4-3. High Pressure Pneumatic Supply System

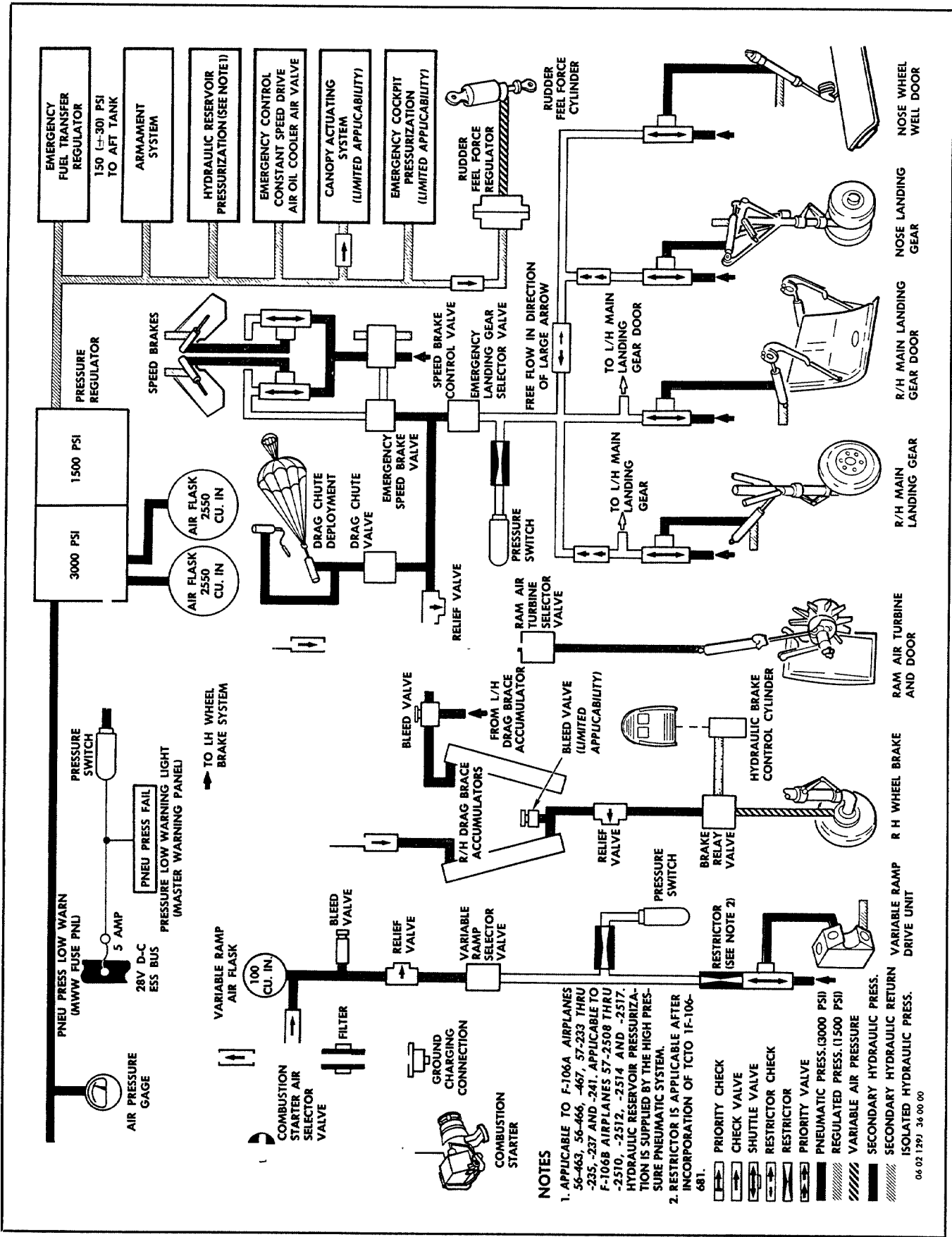

- NOTES**
1. APPLICABLE TO F-106A AIRPLANES 56-463, 56-466, -467, 57-233 THRU -235, -237 AND -241. APPLICABLE TO F-106B AIRPLANES 57-2508 THRU -2510, -2512, -2514 AND -2517. HYDRAULIC RESERVOIR PRESSURIZATION IS SUPPLIED BY THE HIGH PRESSURE PNEUMATIC SYSTEM.
 2. RESTRICTOR IS APPLICABLE AFTER INCORPORATION OF TCTO 1F-106-681.
- PRIORITY CHECK
 - CHECK VALVE
 - SHUTTLE VALVE
 - RESTRICTOR CHECK
 - RESTRICTOR
 - PRIORITY VALVE
 - PNEUMATIC PRESS. (3000 PSI)
 - REGULATED PRESS. (1500 PSI)
 - VARIABLE AIR PRESSURE
 - SECONDARY HYDRAULIC PRESS.
 - ISOLATED HYDRAULIC RETURN.

Figure 4-4. High Pressure Pneumatically Operated Systems

HIGH PRESSURE PNEUMATIC SUB-SYSTEMS

4-7. GENERAL.

The sub-systems and the pressures they require are listed in paragraph 4-3. Refer to the manuals referenced in the following paragraphs for a detailed description of any component or sub-system of the high pressure pneumatic system.

4-8. MISSILE BAY DOOR AND MISSILE LAUNCHING PNEUMATIC SYSTEM.

The high pressure pneumatic system furnishes 1500-psi air pressure to operate the missile bay doors and missile launching system. An electrical signal to the master door selector valve directs high pressure air to door selector slave valves which in turn control air pressure to missile bay door cylinders. A signal to solenoid "A" of the master door selector valve ports "extend pilot" pressure to the door selector slave valves. The slave valves move to the detented extend position directing 1500 psi air to the extend side of the door cylinders. This air unlocks the internal up-lock latches and extends the cylinder actuators for a door open operation. Retract pressure is always present at the door cylinders; therefore it is only necessary for the slave valves to vent the extend pressure for a door close operation. This is accomplished when solenoid "B" of the master selector is electrically operated to port "retract pilot" pressure to the slave valves. A pneumatic interlock exists between launchers and doors. Launchers cannot extend until "extend pilot" pressure is available from the door selector valve. The operation of the missile launching system begins after the doors have reached the full open position because of the electrical interlocking circuit. Electrical operation of solenoid "A" to either the forward or aft launcher solenoid operated selector valves routes high pressure air to the extend side of the displacement assembly cylinders to extend the launchers. When solenoid "B" of either the forward or aft solenoid operated selector valves is operated, high pressure air is routed to the retract side of the cylinders for retracting the launchers. Air on the extend side of the cylinders is then vented to atmosphere. Refer to T.O. 1F-106A-2-12 for complete coverage of the armament system.

4-9. RUDDER ARTIFICIAL FEEL SYSTEM.

The rudder artificial feel system consists of a variable air pressure regulator, a feel force cylinder, and pneumatic tubing. This system provides the pilot with an artificial feel of aerodynamic forces. The feel force cylinder, actuated by regulated high pressure air from the high pressure pneumatic system, is a cylinder and piston assembly. The air pressure in the cylinder varies in proportion to ram air pressure which is a function of air speed and altitude. As the air pressure in the cylinder varies, the force on the piston varies. This force is felt

by the pilot as resistance to movement of the rudder pedals. The variable air pressure regulator consists of a spring-loaded diaphragm and pressure regulator. Variations of ram air pressure imposed on the diaphragm cause variations in high pressure air, which is routed to the rudder feel force cylinder. The output pressures range from 40 to 1100 psi. Refer to T.O. 1F-106A-2-7 for complete coverage of this system.

4-10. EMERGENCY COCKPIT PRESSURIZATION SYSTEM.

The emergency cockpit pressurization system will automatically maintain cockpit pressure in event of a loss of normal supply pressure at high altitudes. The emergency system is activated when the cockpit low pressure warning system is energized. When activated, regulated high pressure pneumatic system air (1500 psi) is supplied to the cockpit and canopy seal pressurization systems. The emergency system receives electrical power from the 28-v dc essential bus through the "CKPT PRESS WARN" fuse on the cockpit right-hand fuse panel. Refer to T.O. 1F-106A-2-6 for detailed description and operation of this system.

4-11. EMERGENCY CG FUEL TRANSFER SYSTEM, F-106A.

The emergency CG fuel transfer system is provided to transfer fuel forward from the transfer tanks to the fuselage tank. This system operates in the event of an engine flame out, or loss of normal tank pressurization after a fuel transfer aft to the transfer tanks has been completed. This system is provided as an aid in preserving the flight stability of the airplane during other than normal operating conditions. The high pressure pneumatic system provides sufficient air for one transfer operation. Refer to T.O. 1F-106A-2-5 for complete coverage of the fuel transfer system.

4-12. CONSTANT SPEED DRIVE AIR-OIL COOLER EMERGENCY VALVE.

Low pressure, engine N₂ bleed air is normally used as a source of pneumatic power for operating the constant speed drive air-oil cooler air valve. This bleed air is tapped off the aft section of the bleed air ducting. In the event of failure in the N₂ bleed air supply, or any other failure that would cause the pressure in the engine accessory compartment to rise to 3.0 psi, an emergency control system is automatically actuated. The emergency system uses high pressure pneumatic power to close the constant speed drive air-oil cooler air valve. When the pressure in the engine accessory compartment has been reduced to 0.75 psi, the emergency control system will be deactuated to restore normal system operation. Refer to T.O. 1F-106A-2-4 for complete coverage of the constant speed drive air-oil cooler system.

4-13. DRAG CHUTE RELEASE SYSTEM.

After landing, the airplane can be slowed and its landing roll shortened by deploying the drag parachute. The drag chute deploy and jettison mechanism is electrically controlled, and pneumatically actuated. The drag chute is controlled through the T-shaped control handle on the pilot's instrument panel(s). Pulling the handle energizes the solenoid of the drag chute control valve. The control valve connects high pressure pneumatic power to the drag chute release mechanisms, and the drag chute is deployed. Pushing in the control handle de-energizes the control valve solenoid, and pneumatic power is vented from the release mechanisms. The drag chute is then jettisoned automatically. Refer to T.O. 1F-106A-2-7 for complete coverage of the drag chute system.

4-14. SPEED BRAKE EMERGENCY EXTENSION SYSTEM.

The speed brakes can be extended pneumatically in the event of a hydraulic power failure. If the drag chute control handle is pulled straight out, rotated 90-degrees to the right, and pulled again, pneumatic power will be applied to the speed brake actuators. When the speed brakes pass the 30-degree open position, the drag chute will be automatically deployed. The speed brakes cannot be retracted pneumatically. Refer to T.O. 1F-106A-2-7 for complete coverage of the speed brake system.

4-15. MAIN LANDING GEAR BRAKE SYSTEM.

Air pressure for landing gear brake operation is stored in the aft drag brace accumulator, on each main landing gear. These accumulators are charged simultaneously with the main air flasks and the forward drag braces. A check valve for each aft drag brace isolates the accumulator to its respective brake. When the brake pedals are depressed, the master brake cylinder pistons force hydraulic fluid to the relay valves mounted on each of the main landing gear struts. The relay valves are then actuated, and admit high pressure air from the drag brace accumulators to the wheel brakes. When the pedals are released, the relay valves are deactuated, and return to the spring-loaded, off position. Refer to T.O. 1F-106A-2-8 for complete coverage on the landing gear brake system.

4-16. COMBUSTION STARTER PNEUMATIC SYSTEM.

The combustion starter for the airplane engine uses pneumatic power supplied from the airplane high pressure pneumatic system, or from an external air compressor unit. A manually operated air valve in the left main wheel well permits the combustion starter to be operated by air connected from the airplane high pressure pneu-

matic system. The valve must be in the "OFF" position at all times, except when it is necessary to start the engine using the airplane's source of high pressure compressed air. Refer to T.O. 1F-106A-2-4 for complete coverage on the combustion starter.

4-17. RAM AIR TURBINE EXTENSION SYSTEM.

The ram air turbine and hydraulic pump assembly supplies emergency hydraulic pressure to the lines of the primary hydraulic power system. The turbine is extended into the airstream by applying high pressure pneumatic power to the turbine extension actuator. The extension control handle is installed in the cockpit. Refer to T.O. 1F-106A-2-3 for complete coverage of the ram air turbine.

4-18. VARIABLE RAMP EMERGENCY RETRACTION SYSTEM.

The high pressure pneumatic system provides 3000-psi air pressure to operate the engine air inlet duct variable ramps during emergency operation. This system is used in the event of a hydraulic system power failure and provides a source of power to drive the ramps to the fully retracted position (ducts open). Air for emergency operation of the variable ramps is obtained from an isolated flask in the airplane high pressure pneumatic system. The flask is isolated by a check valve. A pressure relief valve is installed in the system adjacent to the flask to relieve pressure in excess of 3200-psi. The flask is installed in the right side of the refrigeration compartment at station 316.0. A screw type air bleed valve is installed in the forward side of the left main wheel well to bleed air pressure from the flask and system. Filling of the ramp pneumatic system is accomplished by normal filling of the airplane high pressure pneumatic system. Refer to T.O. 1F-106A-2-4 for complete coverage on this system.

4-19. EMERGENCY LANDING GEAR EXTENSION SYSTEM.

The high pressure pneumatic system provides power for extending the landing gear in case of electrical or hydraulic system failure. No provision is made for pneumatically retracting the landing gear. Emergency landing gear extension is initiated by pushing down and then pulling aft on the emergency gear control handle. *Applicable to F-106A airplanes 59-031 and subsequent, and F-106B airplanes 59-149 and subsequent*, the emergency handle is moved inboard prior to pulling aft to prevent accidental change in throttle setting. The handle actuates the landing gear emergency control valve, and pneumatic power is applied to the landing gear actuating cylinders. Shuttle valves in the supply lines prevent the inter-mixing of air and hydraulic fluid. Refer to T.O. 1F-106A-2-8 for complete coverage of the landing gear system.

LOW PRESSURE PNEUMATIC SUPPLY SYSTEM

4-20. GENERAL.

The low pressure pneumatic supply system conducts compressed air bled from the N₂ compressor stage of the airplane engine to various sub-systems. Most of this air passes through a refrigeration unit where it is cooled for use in the cockpit and electronics compartments air conditioning and pressurization system. Hot bleed air is used in the following systems: engine anti-ice system, inlet duct lip anti-ice system, windshield rain-clearing system, elevator artificial feel system, and engine and accessory cooling system. Hot bleed air is also used to pressurize

the primary and secondary hydraulic reservoirs. Partly cooled bleed air is obtained from the heat exchanger of the refrigeration unit, and is used to pressurize the canopy seal, the pilot's anti-G suit, the inlet duct variable ramp seal, the fuel system, and the radome anti-ice fluid tank. *Applicable to F-106B airplanes 57-2516 thru 57-2522*, partially cooled air from the heat exchanger is supplied to the control head of the electronics compartment pressure regulator for use as an actuating force. A schematic illustration of the low pressure pneumatic supply system is shown on figure 4-5.

LOW PRESSURE PNEUMATIC SUB-SYSTEMS

4-21. GENERAL.

The low pressure pneumatic sub-systems use bleed air from the N₂ compressor stage of the airplane engine. This air is distributed by the low pressure pneumatic supply system. For complete coverage of the sub-systems, refer to the maintenance manuals referenced in the following paragraphs.

4-22. AIR CONDITIONING SYSTEM.

The cockpit and the electronics compartments are supplied with refrigerated engine bleed air conditioned by passage through the refrigeration unit. Refrigerated air supplied to the electronics compartments and to the cockpit is temperature regulated by the addition of controlled amounts of hot engine bleed air. Ram air is available, at the option of the pilot, for cockpit and electronics compartments ventilation. Refer to T.O. 1F-106A-2-6 for coverage of the air conditioning system.

4-23. HOT AIR ANTI-ICE AND DEFOG SYSTEM.

The engine anti-ice system taps hot compressed air from the engine diffuser section. The engine inlet duct lip anti-ice system and the windshield rain clearing system use hot engine bleed air tapped from the low pressure pneumatic supply ducting near the refrigeration unit. The radome anti-ice fluid tank is pressurized by partially cooled bleed air from the heat exchanger. Refer to T.O. 1F-106A-2-6 for complete coverage of the anti-ice and defog systems.

4-24. ELEVATOR ARTIFICIAL FEEL SYSTEM.

The elevator artificial feel system uses engine N₂ bleed air to actuate a valve within the feel-force regulator. Control of the valve is accomplished by differential pressure between ram air and static air pressure. Refer to paragraph 8-11, and to T.O. 1F-106A-2-7 for complete coverage of the elevator feel system.

4-25. HYDRAULIC RESERVOIRS PRESSURIZATION SYSTEM.

The primary and secondary hydraulic reservoirs are pressurized to 50 psi by regulated engine bleed air tapped from the aft section of the low pressure pneumatic supply system ducting. The bleed air is supplied to the reservoirs through check valves and a pneumatic filter. Each reservoir has its own pressure regulator and check valve. The check valve prevents back flow from the reservoir when the bleed air supply pressure drops below 50 psi. The pressure regulator and relief valve assembly vents excessive reservoir pressures. Refer to T.O. 1F-106A-2-3 for complete coverage of the hydraulic reservoirs pressurization system.

4-26. FUEL PRESSURIZATION SYSTEM.

The airplane fuel tanks are pressurized by partially cooled air tapped from the refrigeration system heat exchanger. Air from the heat exchanger is supplied to the system through a check valve and the primary air pressure regulator. Pressurization reduces fuel vaporization, and provides the motive power for both normal and center of gravity control fuel transfer operations. Refer to T.O. 1F-106A-2-5 for complete information relating to the fuel pressurization system.

4-27. PILOT'S ANTI-G SUIT PRESSURIZATION SYSTEM.

The pilot's anti-G suit is automatically pressurized during flight maneuvers exceeding 1½ to 2 Gs. Partially cooled air, from the refrigeration unit heat exchanger, is routed to the suit through an air pressure regulator. The anti-G regulator is located on the left side of the cockpit. The regulator incorporates a manually operated button. When the button is depressed, air pressure from the heat exchanger will bypass the regulator to pressurize the suit. *Applicable to F-106B airplanes*, the aft cockpit is

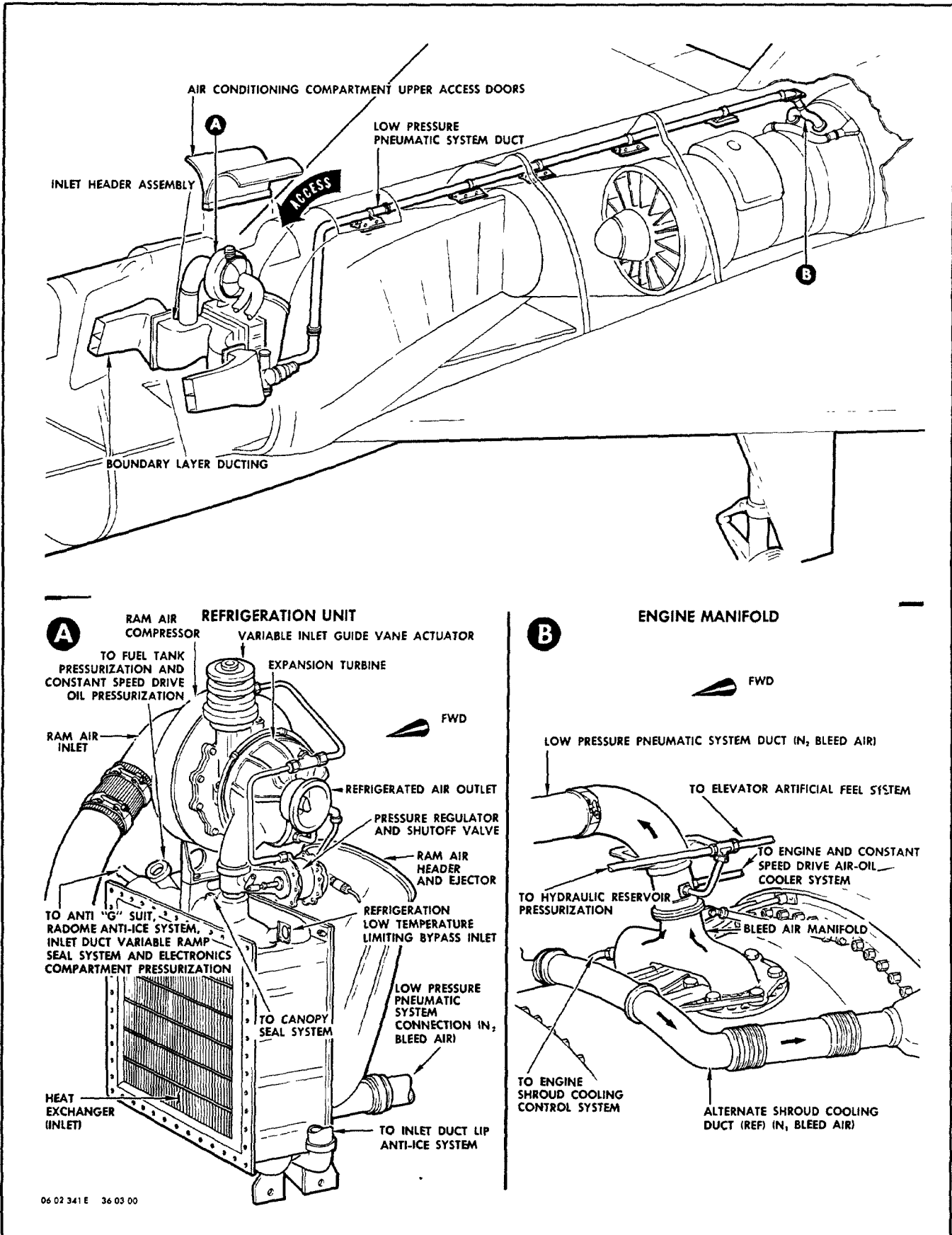

Figure 4-5. Low Pressure Pneumatic Supply System

furnished with an identical system. Refer to T.O. 1F-106A-2-2 for information regarding the pilot's suit anti-G system.

4-28. ENGINE AND ACCESSORY COOLING SYSTEM.

The engine compartment cooling airflow is divided into two flow systems that are provided to cool two separated engine area compartments. The first compartment consists of the engine accessory area which is normally cooled by air received through the constant speed drive unit air-oil cooler. The second compartment consists of the combustion chamber and the turbine area. Cooling air for this area is normally ducted from a scroll which encircles the engine air inlet duct. Under certain conditions, such as ground operation or in flight, when necessary to prevent a negative pressure in the engine shroud area, low pressure air tapped from the forward (N_1) engine compressor is supplied to the shroud area for cooling and pressurization. The combustion chamber and turbine compartment cooling air is vented overboard between the afterburner nozzle and the engine shroud. Cooling air from the accessory compartment passes between the fuselage and turbine area shroud and is vented overboard between the fuselage tail cone and shroud. Engine N_2 bleed air, tapped from the aft section of the low pressure pneumatic system ducting, actuates an electrically controlled valve which controls the flow of air to each air-oil cooler. Refer to T.O. 1F-106A-2-4 for complete coverage of this system.

4-29. CANOPY SEAL PRESSURIZATION SYSTEM.

The canopy seal system uses partially cooled bleed air tapped from the refrigeration unit heat exchanger to

automatically inflate the rubber seal installed around the edge of the cockpit canopy. The seal prevents the loss of cockpit pressure. Refer to paragraph 7-5 for a brief description, and to T.O. 1F-106A-2-2 for complete information relating to the canopy seal pressurization system.

4-30. INLET DUCT VARIABLE RAMP SEAL PRESSURIZATION SYSTEM.

A variable ramp is provided in each of the two engine inlet ducts to control engine inlet pressure. Above certain airspeeds, the ramps are extended into the ducts to restrict the airflow, and to reduce the turbulence of air entering the engine. An inflatable seal is secured to the upper and lower edges of each ramp and the ramp hinge areas. When inflated, the seal prevents ram air from entering the area behind the extended ramp. The seal is pressurized while the engine is running by partially cooled bleed air tapped from the refrigeration unit heat exchanger. Refer to T.O. 1F-106A-2-4 for further information on the variable ramp pressurization system.

4-31. CONSTANT SPEED DRIVE OIL SYSTEM PRESSURIZATION.

The constant speed drive lubrication system is pressurized to 5 psi to maintain operating efficiency of the oil pumps at high altitudes. Engine bleed air is tapped from the main fuel supply system tank pressurization line to pressurize the oil system. The system is pressurized only when the airplane is at altitudes above 22,000 feet. Air pressure is also supplied to all generators to prevent oil leakage past the generator seals. Refer to T.O. 1F-106A-2-4 for detailed description of this system.

Section V

POWER PLANT

<i>Contents</i>	<i>Page</i>
Power Plant General	5-1
Main Fuel System	5-5
Afterburner Systems	5-5
Air Induction Systems	5-6
Starting and Ignition Systems	5-7
Lubrication System	5-8
Anti-Surge Bleed System	5-8
Engine Anti-Icing System	5-8
Constant Speed Generator Drive System	5-9
Engine Drainage Provisions	5-9

POWER PLANT GENERAL

5-1. DESCRIPTION.

The F-106A and F-106B airplanes are powered by Pratt and Whitney, J-75 continuous flow gas turbine engines equipped with afterburners. The J-75 engine is composed of the following four major sections as illustrated on figure 5-1: the compressor section, turbine and afterburner diffuser section, accessory section, and the afterburner section. The compressor section supplies the burner section of the engine with a high velocity flow of compressed air. The compressor itself is divided into two sections: the low-pressure or N_1 compressor which consists of eight compression stages; and the high-pressure or N_2 compressor, which is made up of seven compression stages. The N_2 compressor section also supplies bleed air pressure for the airplane's low pressure pneumatic system. Combustion of fuel-air mixture occurs in the turbine and afterburner diffuser section. The afterburner section consists of the afterburner duct and the variable area two-position exhaust nozzle assembly at the aft end of the engine. The afterburner section is described in paragraph 5-5. The accessory section is located at the bottom of the engine in the area of the smallest engine diameter. Components making up the accessory section are the oil pump

and accessory drive housing, the fuel pressurizing and dump valve, the fuel pump, the fuel transfer valve, the fuel control, the afterburner fuel control, the afterburner nozzle actuator control, two hydraulic pumps, the constant speed drive unit gear box, the engine starter, and the tachometer generator. Power for driving the engine accessories is provided by interconnecting shafts between the N_2 compressor rotor and the oil pump and accessory drive housing. The engine is illustrated on figure 5-2. Refer to T.O. 1F-106A-2-4 for specific information concerning the F-106A and F-106B engines.

5-2. ENGINE DIRECTIONAL REFERENCES.

Engine directional references such as right and left, clockwise and counterclockwise, upper and lower, apply to the engine as viewed from the rear or afterburner end. The engine is in the normal horizontal position with the N_2 accessory at the bottom. Direction of rotation of compressor and turbine assemblies is clockwise. The combustion chambers are numbered from one through eight in a clockwise direction, with the number one burner located to the right of the engine top centerline.

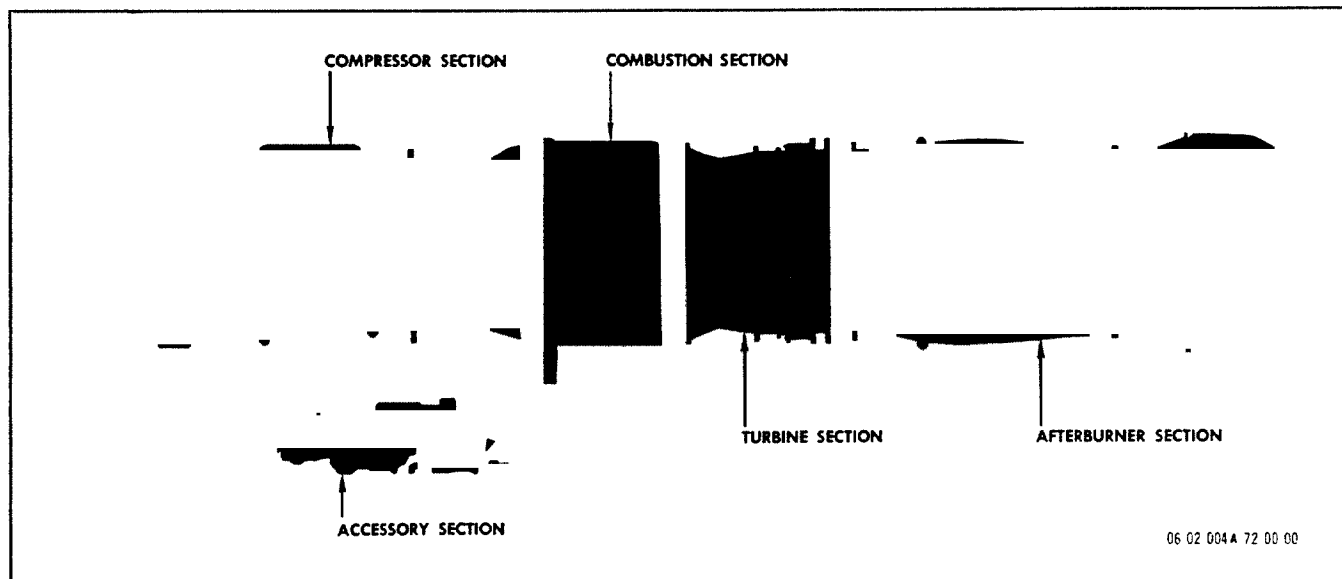

Figure 5-1. Engine Sections

5-3. ENGINE INSTRUMENTS AND WARNING SYSTEMS.

The engine instruments and warning systems provide the pilot with a continuous indication of engine oper-

ating conditions. The indicators for these systems are grouped together in the cockpit for easy reference. Refer to T.O. 1F-106A-2-9 for specific information concerning the engine instruments. These systems and their functions are as follows:

UNIT	LOCATION	FUNCTION
Tachometer Indicator	Main instrument panel	To provide pilot with an indication of N_2 compressor rpm.
Pressure Ratio Indicator	Main instrument panel	To provide pilot with an indication of engine thrust output.
Exhaust Temperature Indicator	Main instrument panel	To provide pilot with an indication of engine exhaust gas temperature.
Fuel Flow Indicator	Main instrument panel	To provide pilot with an indication of fuel consumption of the engine.
N_1 Compressor Overspeed Warning Light	Master warning panel	To provide pilot with an indication of N_1 compressor overspeed.
Engine Oil Pressure Indicator	Main instrument panel	To provide pilot with an indication of engine oil pressure.
Engine Oil Low Pressure Warning Light	Master warning panel	To provide pilot with a warning indication of low engine oil pressure.
Variable Ramp Not Retracted Warning Light	Main instrument panel	To provide pilot with an indication that the ramps are not fully retracted.

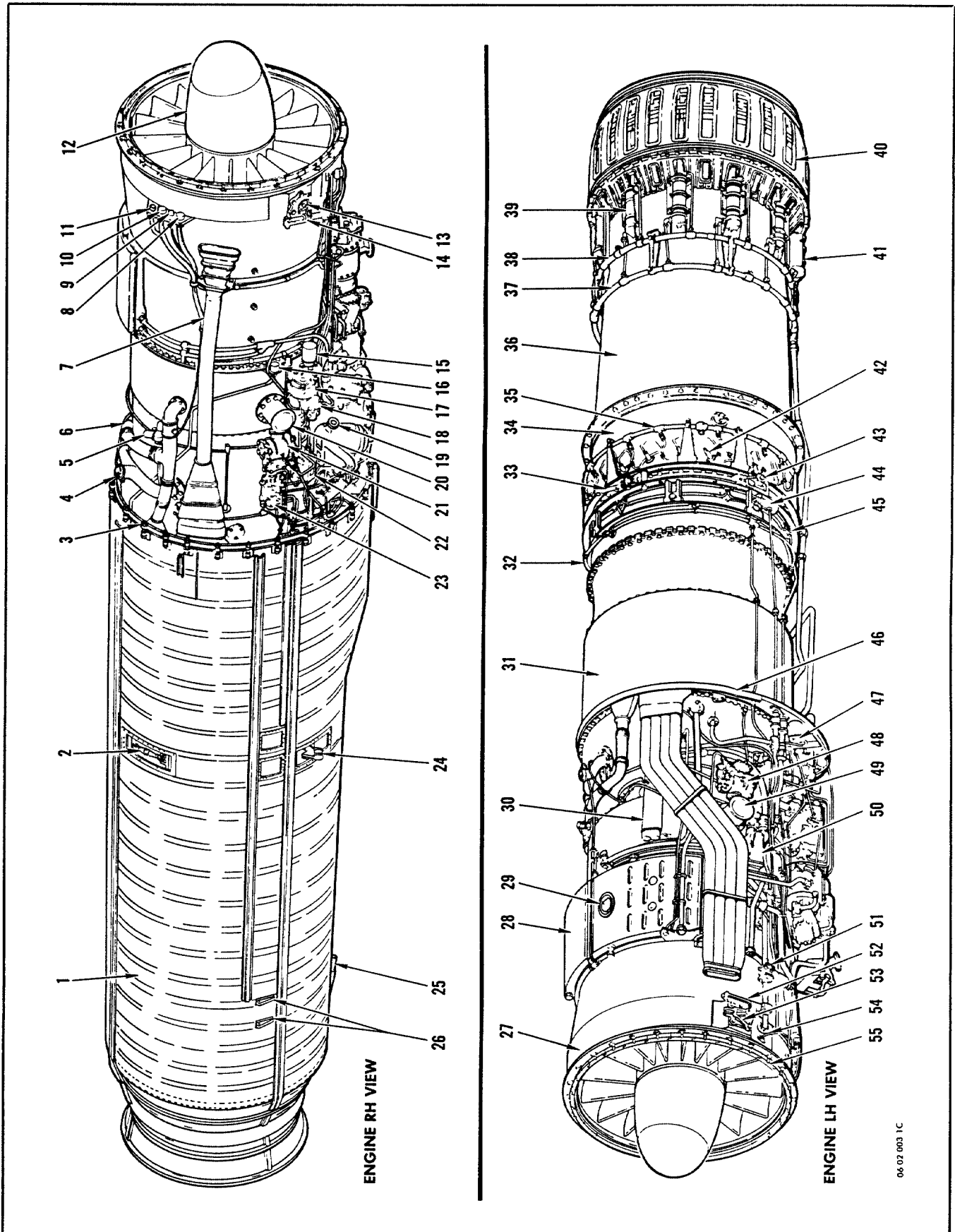
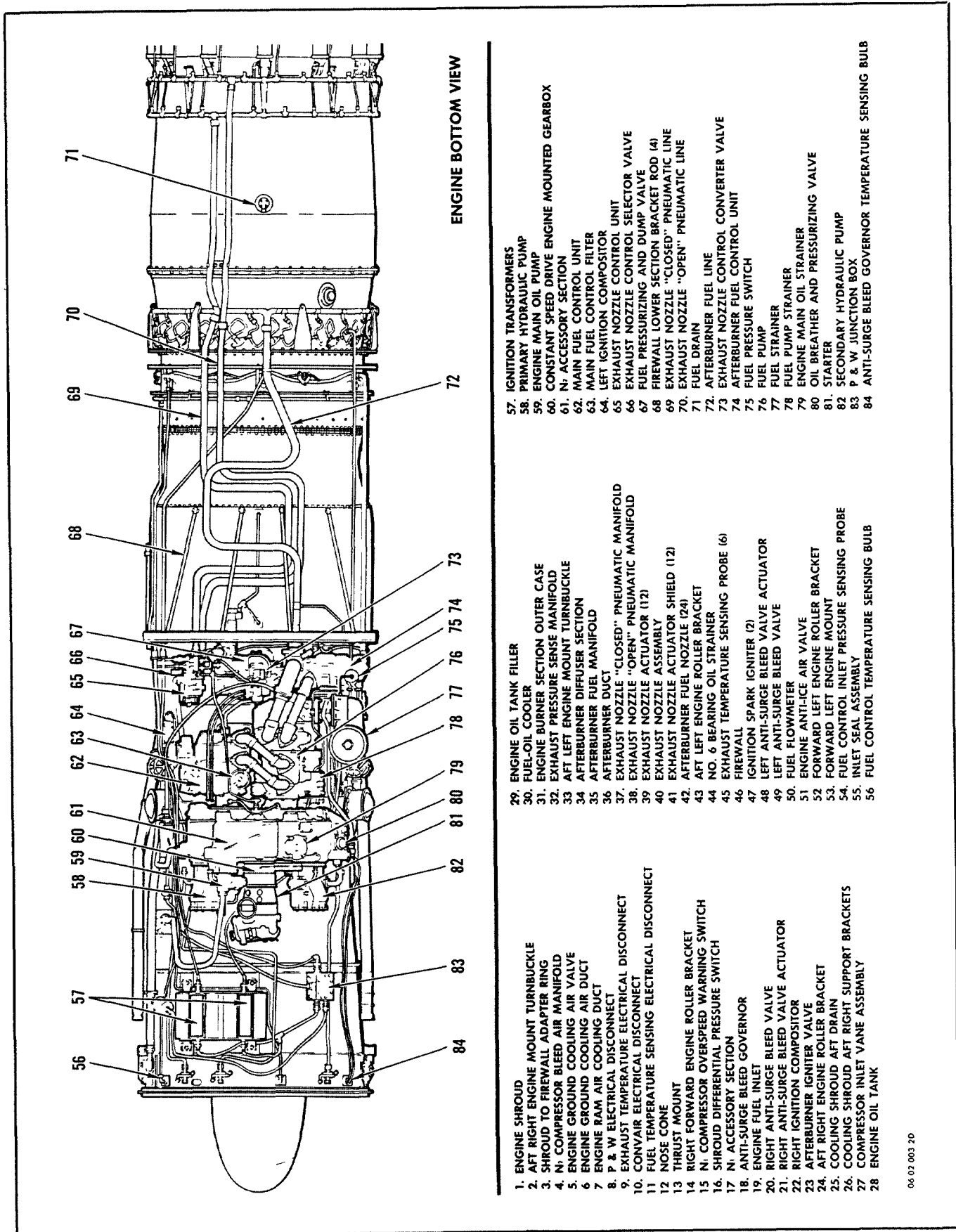

Figure 5-2. Engine Accessories (Sheet 1 of 2)

06 02 003 1C



ENGINE BOTTOM VIEW

- | | | |
|--|--|--|
| <p>1. ENGINE SHROUD
2. AFT RIGHT ENGINE MOUNT TURNBUCKLE
3. SHROUD TO FIREWALL ADAPTER RING
4. N. COMPRESSOR BLEED AIR MANIFOLD
5. ENGINE GROUND COOLING AIR VALVE
6. ENGINE GROUND COOLING AIR DUCT
7. ENGINE RAM AIR COOLING DUCT
8. P & W ELECTRICAL DISCONNECT
9. EXHAUST TEMPERATURE ELECTRICAL DISCONNECT
10. CONVAIR ELECTRICAL DISCONNECT
11. FUEL TEMPERATURE SENSING ELECTRICAL DISCONNECT
12. NOSE CONE
13. THRUST MOUNT
14. RIGHT FORWARD ENGINE ROLLER BRACKET
15. N. COMPRESSOR OVERSPEED WARNING SWITCH
16. SHROUD DIFFERENTIAL PRESSURE SWITCH
17. N. ACCESSORY SECTION
18. ANTI-SURGE BLEED GOVERNOR
19. ENGINE FUEL INLET
20. RIGHT ANTI-SURGE BLEED VALVE
21. RIGHT ANTI-SURGE BLEED VALVE ACTUATOR
22. RIGHT IGNITION COMPOSITOR
23. AFTERBURNER IGNITER VALVE
24. AFT RIGHT ENGINE ROLLER BRACKET
25. COOLING SHROUD AFT DRAIN
26. COOLING SHROUD AFT RIGHT SUPPORT BRACKETS
27. COMPRESSOR INLET VANE ASSEMBLY
28. ENGINE OIL TANK</p> | <p>29. ENGINE OIL TANK FILLER
30. FUEL-OIL COOLER
31. ENGINE BURNER SECTION OUTER CASE
32. EXHAUST PRESSURE SENSE MANIFOLD
33. AFT LEFT ENGINE MOUNT TURNBUCKLE
34. AFTERBURNER DIFFUSER SECTION
35. AFTERBURNER FUEL MANIFOLD
36. AFTERBURNER DUCT
37. EXHAUST NOZZLE "CLOSED" PNEUMATIC MANIFOLD
38. EXHAUST NOZZLE "OPEN" PNEUMATIC MANIFOLD
39. EXHAUST NOZZLE ACTUATOR (12)
40. EXHAUST NOZZLE ASSEMBLY
41. EXHAUST NOZZLE ACTUATOR SHIELD (12)
42. AFTERBURNER FUEL NOZZLE (24)
43. AFT LEFT ENGINE ROLLER BRACKET
44. NO. 6 BEARING OIL STRAINER
45. EXHAUST TEMPERATURE SENSING PROBE (6)
46. FIREWALL
47. IGNITION SPARK IGNITER (2)
48. LEFT ANTI-SURGE BLEED VALVE ACTUATOR
49. LEFT ANTI-SURGE BLEED VALVE
50. FUEL FLOWMETER
51. ENGINE ANTI-ICE AIR VALVE
52. FORWARD LEFT ENGINE ROLLER BRACKET
53. FORWARD LEFT ENGINE MOUNT
54. FUEL CONTROL INLET PRESSURE SENSING PROBE
55. INLET SEAL ASSEMBLY
56. FUEL CONTROL TEMPERATURE SENSING BULB</p> | <p>57. IGNITION TRANSFORMERS
58. PRIMARY HYDRAULIC PUMP
59. ENGINE MAIN OIL PUMP
60. CONSTANT SPEED DRIVE ENGINE MOUNTED GEARBOX
61. N. ACCESSORY SECTION
62. MAIN FUEL CONTROL UNIT
63. MAIN FUEL CONTROL FILTER
64. LEFT IGNITION COMPOSITOR
65. EXHAUST NOZZLE CONTROL UNIT
66. EXHAUST NOZZLE CONTROL SELECTOR VALVE
67. FUEL PRESSURIZING AND DUMP VALVE
68. FIREWALL LOWER SECTION BRACKET ROD (4)
69. EXHAUST NOZZLE "CLOSED" PNEUMATIC LINE
70. EXHAUST NOZZLE "OPEN" PNEUMATIC LINE
71. FUEL DRAIN
72. AFTERBURNER FUEL LINE
73. EXHAUST NOZZLE CONTROL CONVERTER VALVE
74. AFTERBURNER FUEL CONTROL UNIT
75. FUEL PRESSURE SWITCH
76. FUEL PUMP
77. FUEL STRAINER
78. FUEL PUMP STRAINER
79. ENGINE MAIN OIL STRAINER
80. OIL BREATHER AND PRESSURIZING VALVE
81. STARTER
82. SECONDARY HYDRAULIC PUMP
83. P & W JUNCTION BOX
84. ANTI-SURGE BLEED GOVERNOR TEMPERATURE SENSING BULB</p> |
|--|--|--|

06 07 003 20

Figure 5-2. Engine Accessories (Sheet 2 of 2)

5-3. ENGINE INSTRUMENTS AND WARNING SYSTEMS (CONT).

UNIT	LOCATION	FUNCTION
Fire and Overheat Detection Warning Light and Test Switch	Pilot's panel	To provide pilot with a warning indication of fire or overheat conditions around the engine.

MAIN FUEL SYSTEM**5-4. GENERAL.**

The engine main fuel system schedules fuel to the engine according to engine requirements under varying operating conditions, thereby controlling engine power output in accordance with throttle setting. The engine main fuel system consists of an engine-driven fuel pump and afterburner fuel pump, a transfer valve, a main fuel control unit, a fuel flowmeter, a fuel strainer, a fuel-oil cooler, a pressurizing-and-dump valve, and burner nozzles and manifolds. The main fuel control unit is the heart of the system and is directly controlled by the pilot by means of the throttle lever and accompanying Teleflex linkage. An emergency feature is incorporated in the fuel control unit in event of malfunction during normal operation. Emergency operation is controlled by a switch on the throttle quadrant. A warning light is located on the instrument panel to provide indication when the unit is in emergency operation. Fuel drawn from the wing fuel tanks by the engine and afterburner fuel pump is used to fulfill the requirements of the main fuel system and afterburner fuel system. During non-afterburning operations, the fuel routed to the afterburner fuel system is

directed to the inlet side of the engine and afterburner fuel pump. A transfer valve is integral with the fuel pump. In event of malfunction in the main fuel section of the pump, the transfer valve will route some fuel scheduled for the afterburner fuel system to the main fuel system. Under this condition, fuel supply to the afterburner fuel system will be reduced, resulting in reduced efficiency during afterburner operation. Main fuel system fuel flow is from the engine and afterburner fuel pump to the main fuel control. Fuel flow is metered by the fuel control, routed through the fuel flow meter and the fuel-oil-cooler to the fuel pressurizing-and-dump valve. The pressurizing-and-dump valve accomplishes two functions: it controls the fuel flow to the primary and secondary injector nozzles in the engine burners, and it dumps the nozzle manifold fuel when the engine has been shut down. The shrouded dual fuel manifold interconnects the 48 dual fuel nozzles. This manifold is built up as one complete assembly. Fuel metering for the engine fuel system terminates at eight combustion chambers, each of which has six dual nozzles. Refer to T.O. 1F-106A-2-4 for specific information concerning the engine main fuel system.

AFTERBURNER SYSTEMS**5-5. ENGINE AFTERBURNER.**

The engine afterburning system is used to increase thrust during takeoff, climb and maximum performance flight. This is accomplished by introducing fuel into the engine exhaust section where it mixes with the hot exhaust gases and is ignited. Afterburner operation is controlled by an electrical switch that is actuated when the throttle is moved to the "AFTERBURNING" section of the throttle quadrant.

No provisions are made for emergency starting of afterburner operation; however, emergency mechanical provi-

sions are incorporated to shutoff afterburning in case of electrical cutoff system failure. The afterburner portion of the engine consists of the afterburner duct and the variable area, two position exhaust nozzle assembly. The exhaust nozzle assembly is composed of iris type shutters, operated by pneumatic actuating cylinders. The cylinders, which are mounted around the outer diameter of the afterburner duct, are actuated by N₂ compressor bleed air metered by the exhaust nozzle control valve. During normal engine operation, the cylinders hold the nozzle iris in the closed position. When afterburning occurs, the

cylinders open the nozzle to permit the less restricted passage of afterburning gases. Refer to T. O. 1F-106A-2-4 for specific afterburner information.

5-6. AFTERBURNER FUEL CONTROL SYSTEM.

The afterburner fuel control system consists of the engine and afterburner fuel pump, an afterburner fuel control, an afterburner igniter valve, an exhaust nozzle control valve, a manual shutoff valve, and the fuel spray bars and manifolds. The engine and afterburner fuel pump also functions as part of the engine main fuel system. After-

burner fuel flow is from the engine and afterburner fuel pump to the afterburner fuel control unit. During non-afterburning operation, the fuel is routed back to the engine and afterburner fuel pump. During afterburner operation, the afterburner fuel control routes metered fuel, under pressure, to the afterburner fuel manifold. Fuel is then routed to 24 afterburner spray bars and discharged into the afterburner duct where it is ignited. Fuel, under pressure from the afterburner fuel manifold, also initiates the afterburner ignition cycle. Refer to T.O. 1F-106A-2-4 for complete coverage of this system.

AIR INDUCTION SYSTEMS

5-7. VARIABLE RAMP SYSTEM.

The variable ramp system is provided to control and position shock waves at the inlet duct lip during flight operations. Control of the shock waves is necessary in order to provide the engine with a stable, constant flow of air regardless of airplane speed, and to prevent air spillage at the intake duct lip with resultant aerodynamic drag. The variable ramp assembly in each duct is composed of three hinged, interlocked sections. These sections are automatically positioned to reduce the size of the duct passage and to control the shock wave pattern, providing a subsonic airflow to the engine for optimum engine operation. The variable ramp system is controlled by a two position switch located on the cockpit left-hand switch panel. Switch positions are provided for automatic and emergency operation. The forward edge of the forward ramp section is hinged to the inlet duct, the angle of which may be varied with respect to the airplane centerline. The center ramp section is hinged to the aft side of the forward ramp section and provides a slight diverging area passage through the inlet duct throat. The third section (diverging flow ramp) incorporates a slip joint connection to the aft side of the center section and provides a smooth contour to fair the ramp to the duct wall regardless of the ramp position. The aft side of the aft ramp section is hinged to the inlet duct. The ramp sections are sealed to the top and bottom of the intake ducts by inflatable seals. These seals are inflated automatically at all times during engine operation, by the airplane low pressure pneumatic system. A pitot-static probe is installed in the throat of each inlet duct to sense air velocity and pressure through the duct. A normal air flow rate through the ducts is maintained by automatic hydraulic-mechanical positioning of the ramps resulting in peak engine performance at full power. The ramp total pressure (P_t) and static pressure (P_s) shuttle valves and the afterburner time delay circuit are incorporated in the system to minimize the effects of ramp duct instability which arise from airflow transients and flight attitudes. Openings are provided in each ramp

assembly to bleed low energy boundary layer air out of the intake ducts. This air is routed to the lower side of the fuselage where it is vented overboard. Each variable ramp is extended and retracted by four screw jacks driven by flexible shafts from a single hydraulic motor. Hydraulic power for motor operation is derived from the airplane secondary hydraulic system. In the event of hydraulic pressure failure, an emergency source of high pressure air, stored in a 100 cu. in. flask, can be selected to drive the ramps to the fully retracted position (ducts open).

5-8. A variable ramp not retracted warning system is incorporated with the variable ramp control circuit. An amber warning light is located on the main instrument panel, on *F-106A* airplanes; on the forward and aft main instrument panel, on *F-106B* airplanes. This light will illuminate in event the variable ramps do not automatically retract when required. The light will also illuminate when the emergency variable ramp system is activated, and will remain illuminated until the ramps have fully retracted. Refer to T.O. 1F-106A-2-4 for complete coverage of the variable ramp system.

5-9. ENGINE COOLING SYSTEM.

The engine compartment cooling air flow is divided into two flow systems that cool two separate engine areas. The first area is the engine accessory section. This area receives cooling air through the constant speed generator drive unit air-oil cooler, and the engine air-oil cooler. The second area is the combustion chamber and turbine section. This area is separated from the engine accessory area by a titanium shroud and firewall. Cooling air for the shrouded area is normally ducted from a scroll that encircles the engine air inlet duct. During engine ground run operation, cooling air for this area is ducted from the engine N_1 compressor section. The combustion chamber and turbine area cooling air is vented overboard between the afterburner nozzle and the engine shroud. Operation of the cooling air flow is automatic with the operation of the engine and the airplane.

5-10. COMBUSTION CHAMBER AND TURBINE COMPARTMENT COOLING.

5-11. Normal Cooling In-Flight.

The combustion chamber and turbine area is normally cooled in flight by air ducted from the engine air inlet duct. The air is routed aft to the engine shroud through two ducts. A check valve is installed in each duct, immediately forward of the shroud, to prevent the reverse flow of cooling air during ground operation.

5-12. Ground Cooling or Pressure Augmentation During Flight.

For ground cooling or for pressure augmentation of the shrouded combustion chamber and turbine compartment, a supply of cooling air is ducted from the N_1 compressor. During certain flight maneuvers, such as a climb with the afterburner on, the pumping action of the engine exhaust tends to pull the air from within the shroud. This creates a negative pressure that could collapse the shroud if it were permitted to continue. To prevent a severe negative pressure condition, a solenoid air valve controls the air flow from the engine N_1 compressor bleed air port. The valve receives power from two switches wired in series; the main landing gear door open limit switch, and a pressure switch mounted in the engine compartment. The landing gear door limit switch prevents the valve from closing when the landing gear is extended. During flight operation, the pressure switch actuates the valve when the pressure differential within the shroud reaches 2.5 psi. When the valve is actuated, N_1 compressor bleed air is ducted into the shroud. The valve will be deactivated when the pressure differential is reduced to 1.3 psi, or when the landing gear is retracted.

5-13. ENGINE ACCESSORY COMPARTMENT COOLING.

The engine accessory area is cooled by air leaving the engine air-oil cooler, and the constant speed generator drive air-oil cooler. The air flows through the engine accessory compartment, passing over the burner and turbine shroud, and exhausts at the aft end of the airplane between the tail cone and the shroud. Some flight conditions increase the pressure in the tail cone area, and tend to increase the pressure in the engine accessory compartment. To protect the fuselage from high pressures resulting from this condition, pressure control is provided by modulating type air valves in the engine and constant speed generator drive oil cooling systems. The constant speed generator drive air-oil cooler air valve is open as long as the differential pressure between engine accessory compartment and ambient pressures is below 1.0 psi. The valve closes as the engine accessory compartment pressure differential increases to 1.5 psi. The engine air-oil cooler is regulated by the fuel temperature sensing phase of the system. It remains under this control as long as the engine accessory compartment pressure is less than 2.0 psi. At 2.0 psi, the fuel temperature control is overridden by the pressure control, and the engine air-oil cooler valve is closed. At this point, the compartment ventilation is completely shut off, with the exception of the fixed amount of air permitted to leak past the closed constant speed generator drive oil cooler air valve. At 1.5 psi, the fuel temperature control again becomes operative, and the engine air-oil cooler air valve opens. The source of power for valve operation is engine high pressure bleed air controlled by solenoid valves.

STARTING AND IGNITION SYSTEMS

5-14. GENERAL.

The engine starting and ignition systems are interrelated in that the operation of one system is dependent upon the other for completion of electrical circuits and starting of the engine. Switches for actuation of the starter and the ignition components are incorporated as a part of the pilot's throttle quadrant assembly. *On F-106B airplanes*, airplane starter actuation is accomplished from the front cockpit only. *On all airplanes*, ignition is used only during starts, and functions only while the pilot depresses the ignition button, which is located on top of the throttle lever. The starter is supplied with fuel from the airplane fuel system, and high-pressure air from the airplane high-pressure pneumatic system or from an external compressed air source. The adapter for attach-

ment of external air source and a manual air selector valve is located in the left main wheel well. The manual air selector valve is used for selection of either source of compressed air. The fuel and air mixture is ignited by the starter ignition system. The starter is actuated by holding the ignition button on the throttle lever depressed, and moving the throttle lever to the "START" position. Engine ignition is supplied to sparkigniters, located in number four and number five combustion chambers, by transformers located on the under side of the engine. Power for transformer operation is supplied from the airplane 28-volt, dc power system. Refer to T.O. 1F-106A-2-4 for detailed coverage of the starting and ignition systems.

LUBRICATION SYSTEM

5-15. GENERAL.

The engine lubrication system is a hot tank type oil pressure system. The hot tank system increases altitude performance by providing better de-aeration of the oil, due to air escaping more readily from hot oil. This is accomplished by routing oil, Specification MIL-L-7808, from the engine scavenge pumps, directly to the oil tank where de-aeration occurs. From the tank, the oil is gravity fed to an engine driven boost pump which forces the oil through the air-oil cooler, fuel-oil cooler, and into the main oil pressure pump. This system provides a positive inlet pressure for the main pump under all operating conditions. The oil passes through the pump and is routed through the bypass equipped main oil strainer to the pressure distribution system. The oil is then routed through the engine bearings and accessory drive section and is picked

up by the scavenge pumps and returned to the oil tank. An integral breather pressurizing system regulates air pressure in the system to maintain proper oil flow at all altitudes. An engine oil low pressure warning system is provided to warn the pilot of engine low oil pressure. Refer to T.O. 1F-106A-2-4 for detailed coverage of the lubrication system.

WARNING

Engine oil, Specification MIL-L-7808, is detrimental to paint and rubber materials. Spilled oil should be wiped up immediately. This oil has an irritating effect on human skin; prolonged contact should be avoided.

ANTI-SURGE BLEED SYSTEM

5-16. GENERAL.

The engine anti-surge system is provided to prevent surging, pulsating, and possible compressor stalling during engine operation. During acceleration or rapid engine speed changes, the forward or N_1 compressor supplies a greater volume of air than can be readily used by the aft or N_2 compressor. The anti-surge system operates at such times, bleeding off excess air until the compressors are balanced. The system consists essentially of a bleed governor, two bleed valves and actuators, screen assemblies, and ducting. In operation, the compressor bleed

governor, driven by the N_1 compressor, senses changes in rpm, air pressure, and temperature in the engine compressor inlet. These sensed conditions are translated into a pneumatic pressure signal to the bleed valve actuators. The pressure signal in turn, actuates the valves to the desired open or closed position. The bleed governor temperature bulb is located in the right-hand side of the engine air inlet guide vane assembly, and is an integral part of the bleed governor assembly. Openings in the fuselage skin vent the bleed air to atmosphere. Refer to T.O. 1F-106A-2-4 for detailed coverage of the anti-surge bleed system.

ENGINE ANTI-ICING SYSTEM

5-17. GENERAL.

The engine anti-icing system is provided to prevent the formation of ice on the engine inlet guide vanes and nose section fairing. The system utilizes engine bleed air controlled by an electrically actuated valve which operates in conjunction with the airplane's automatic anti-ice

system. The system consists of a bleed air transfer line on the left side of the engine, and an electrically actuated valve. The air line routes engine N_2 bleed air, heated by compression, forward to the engine inlet guide vanes. Control of the air flow is accomplished by the electrically actuated valve installed in this line. When the valve is open, the heated air flows into the engine inlet guide

vane manifold at approximately the nine o'clock position on the inlet case. The air passes inward through the guide vanes and is routed forward into the engine nose cone. The cone then vents the air aft into the engine intake air stream. Refer to T. O. 1F-106A-2-4 for detailed coverage of the engine anti-ice system. The engine inlet duct lip anti-ice system is provided to prevent formation of ice on the leading edges of the engine air inlet ducts. Hot

engine bleed air is routed from the bleed air duct at the cockpit air conditioning system heat exchanger, through tubing to the duct leading edges. Air flow is controlled by a combination solenoid-controlled, pneumatically-actuated pressure regulator and shutoff valve. The system is controlled by the anti-ice switch in the cockpit. Refer to T.O. 1F-106A-2-6 for detailed description and operation of this system.

CONSTANT SPEED GENERATOR DRIVE SYSTEM

5-18. GENERAL.

The constant speed generator drive system uses mechanical power from the airplane engine to drive the airplane generators. The system consists of an engine-mounted gear box, a fuselage mounted transmission and remote gearbox assembly, and an interconnecting drive shaft. The drive shaft transmits mechanical power to the transmission of the remote gear box assembly. The airplane generators are mounted on the drive pads of the remote gear box. The output to the generators is maintained at a constant speed despite variations in electrical power loading, and regardless of variations in the input speeds from the engine-mounted gear box. The remote gear box assures constant output speeds regardless of changes in the input speed above certain low limits. The following Protective devices are incorporated in the transmission and remote gear box: the overspeed device, the underspeed device, and the input spline shear section. The overspeed device automatically limits generator speeds, and trips the generators from the line when the generator speeds reach 107.5 to 117.5 percent of their normal rate.

The underspeed device actuates under pressure from the speed governor to trip the generators from the line when generator speeds drop below 92.5 to 87.5 percent of their rated speed. The generators are restored to the line when their input speeds rise to 92.5 percent of the rated speed. The input spline section and the engine-mounted gear box output shaft will shear to decouple the gear box from the engine when severe overloads occur, or when the gear box is not operating properly. The input spline shear section will shear at 1100 (± 80) foot pounds; the gear box output shaft section will shear at 4000 (± 400) inch pounds. The generators are automatically removed from the line when either section is sheared. The constant speed generator drive oil system supplies the oil necessary for operating and lubricating the two gear boxes and the generator bearings, and to cool the generators. Each gear box is equipped with a low point chip detector magnetic drain plug. Refer to T.O. 1F-106A-2-4 and T.O. 1F-106A-2-10 for detailed description and operation of this system.

ENGINE DRAINAGE PROVISIONS

5-19. GENERAL.

Liquid leakage from engine-mounted components and accessories is manifolded and drained overboard through drain ports along the lower side of the fuselage, adjacent to the engine. Each of the drain lines is equipped with disconnect points, to facilitate removal of the engine. The function and operation of drainage from the various components is governed by the type of system involved. Some areas drain only when the engine is not operating. These eliminate the accumulation of liquids,

some of which are normally used during engine operation. The drains may be classified as two types: the first as weep drains which permit elimination of liquids at any time, independent of engine operation; the second as those permitting drainage only during certain engine operating configurations. An abnormal amount of drainage at any of the drain points indicates engine component malfunction or possible impending failure. Refer to T.O. 1F-106A-2-4 for complete coverage on engine drainage provisions.

Section VI

FUEL SUPPLY SYSTEM

<i>Contents</i>	<i>Page</i>
Fuel System	6-1
Pressurization and Venting	6-2
Main Fuel System	6-2
Center of Gravity Control Transfer System	6-2
External Fuel Tank System	6-2
Fuel Quantity Indication System	6-2
Refueling	6-9
Defueling	6-9

FUEL SYSTEM

6-1. FUEL SYSTEM GENERAL.

The F-106A and F-106B airplanes incorporate nine integral fuel tanks. Four tanks are located in each wing and one tank is located in the fuselage. The wing tanks are identified as tank No. 1, tank No. 2, tank No. 3, and the transfer tank. The tank in the fuselage is identified as the fuselage tank. Provisions are also incorporated for installing an external jettisonable fuel tank to the underside of each wing. All integral fuel tanks are built as a part of the basic structure of the airplane. See figures 6-1 and 6-2 for location of fuel tanks and components. Each tank is provided with large structural access doors that are installed with flush screws and self-sealing dome-type nutplates. All fuel tanks are normally closed to atmosphere except during refueling, fuel transferring, and extreme flight maneuvers. The pressure required to force the fuel from one tank to another is obtained from engine bleed air. Bellmouth transfer tubes are provided to transfer the fuel between tanks. Air pressure regulators maintain the pressure differential necessary for sequencing fuel flow to the proper tanks. Two boost pumps provide additional motive power to ensure adequate fuel supply to the engine. A fuel flow equalizer maintains a balanced flow from the No. 3 tanks in each wing and directs the fuel to the engine driven fuel pump. The fuel system includes a normal fuel transfer system, a center of gravity control

transfer system, a replenishing-fuel transfer system, and fuel scavenge and low warning system. Automatic transfer of fuel between the tanks in each wing is referred to as normal fuel transfer. *On applicable airplanes*, a cg control fuel transfer system is incorporated in the fuel system to maintain correct airplane center of gravity location under varying flight conditions. This is accomplished by moving the fuel in the fuselage tank aft to the transfer tanks or forward from the transfer tanks to the fuselage tank. *Applicable to all F-106A airplanes*, the fuselage and transfer tanks replenish the main fuel system when specified fuel levels are reached. *On applicable airplanes*, the fuel scavenge and low warning system indicates when the fuel level is low by means of warning lights on the forward and aft warning indication panels. When the warning lights illuminate, the fuel scavenge system is energized, opening the scavenge fuel valve and the scavenge air valve, forcing residual fuel into the No. 3 tank. Refueling of the integral fuel tanks is accomplished through a single point pressure fitting at the lower right side of the engine inlet duct fairing. The external tanks must be refueled individually through a filler opening on the upper surface of each tank. The fuel used is JP-4, Specification MIL-J-5624. Alternate fuels may be used under specified conditions. Refer to T.O. 1F-106A-2-5

for this information. Defueling of the airplane is accomplished by connecting a defueling truck to the manual defueling valve in the engine accessory compartment. Motive power for defueling may be provided by external pressurization of the fuel tanks, by the airplane fuel boost pumps, or by suction from the defueling truck. See figures 6-3 and 6-4 for a diagram of the fuel system. Refer to T.O. 1F-106A-2-5 for complete coverage of the fuel system.

6-2. PRESSURIZATION AND VENTING.

NOTE

All references to air pressure in the following descriptions are gage pressures unless otherwise noted.

Engine bleed air, supplied to the primary air pressure regulator, is reduced to 21.0 (± 1.0) psi and routed to a main air pressure line. All air pressure used in the fuel pressurization system is tapped from the main air pressure line. Pressurization reduces fuel vaporization and provides motive power for transferring fuel. Vent and pressure relief components in the system prevent excessive positive pressure build-up in the fuel tanks; vacuum relief valves prevent negative pressures within the tanks. All tanks are normally closed to atmosphere except during refueling, fuel transferring, and extreme flight maneuvers. Each wing system is provided with an air pressure regulator connected to the main air pressure line. These regulators are set at 4.5 (± 1.0) psi to pressurize tanks No. 1, No. 2, and No. 3 for normal fuel transfer. The fuselage tank and each transfer tank is provided with a combination air pressure regulator-and-shutoff valve, connected to the main air pressure line. The fuselage tank regulator is set at 13.0 (± 1.0) psi. The transfer tank regulators are set at 17.0 (± 1.0) psi. The shutoff portion of these units are opened and closed by controlling air pressure. When opened, air pressure is routed through the regulators to pressurize respective tanks. A regulator crossfeed line is connected to the outlet line of each transfer tank regulator. In the event one of the regulators fails in the closed position, the opposite regulator will provide pressurization for both transfer tanks. Refer to T.O. 1F-106A-2-5 for complete coverage of the pressurization and venting system.

6-3. MAIN FUEL SYSTEM.

The main fuel system consists of three integral fuel tanks in each wing, that incorporate tubing and components necessary to supply the engine with all available fuel. Various subsystems are required to perform this function. The three tanks, in each wing, are identified as Tank No. 1, Tank No. 2 and Tank No. 3. These tanks are interconnected with bellmouth transfer tubes. *Applicable to all airplanes after incorporation of TCTO 1F-106-693*, a fuel hopper is installed in the aft inboard corner of each No. 3 tank. During maneuvers which tend to force the fuel forward or outboard, fuel is trapped within the hopper to supply the engine. Refer to 1F-106A-2-5 for complete coverage of this system.

6-4. CENTER OF GRAVITY CONTROL TRANSFER SYSTEM.

The cg fuel transfer system consists of the fuselage tank, a transfer tank in each wing, and tubing and components to accomplish cg fuel transfer. The fuselage tank is connected to each transfer tank by the cg fuel transfer line. The cg fuel transfer system controls the center of gravity of the airplane at specific altitudes and airspeeds. This is accomplished by moving the fuel in the fuselage tank aft to the transfer tanks or forward from the transfer tanks to the fuselage tank. *Applicable to F-106A airplanes*, the system is activated by the air data computer system in series with an altitude-pressure-ratio-switch. A three-position manually operated "CG CONTROL" switch is used to control this system. *Applicable to F-106B airplanes*, the center of gravity of the airplane is automatically controlled by sequencing of fuel transfer in the following order. After the external tanks are depleted and 35 gallons removed from each No. 1 tank, the fuselage tank replenishes the No. 1 tanks at approximately engine consumption rate. When the fuselage tank is empty, the remainder of fuel in the No. 1 tanks is used, all fuel in No. 2 tanks and the transfer tanks, then fuel in the No. 3 tanks. This sequence maintains balance of the airplane at all times. The pressurization system provides motive power for normal cg fuel transfer. Power for emergency cg transfer is supplied by the high pressure pneumatic system. Refer to T.O. 1F-106A-2-5 for complete coverage of this system.

6-5. EXTERNAL FUEL TANK SYSTEM.

The external fuel tanks, when installed, become a part of the main fuel system for each wing. These tanks will replenish the respective No. 1 tanks on demand. The fuel tank pressurization system provides the motive power for this transfer. The external fuel tanks have a capacity of 230 US gallons each, and increase the airplane's usable fuel capacity by approximately 460 US gallons. The tank/pylon assembly is jettisoned from the wing by a release mechanism containing an ejector gun and ballistic charge which is electrically controlled. The external tank ejection switch is labeled "WING TANK RELEASE." The release mechanism has manual release provisions for ground handling. Quick disconnect fittings are provided to facilitate ejection. Spring-loaded flaps close the openings in the wing when the tanks are ejected or are not installed. T.O. 1F-106A-2-5 contains complete coverage of the external fuel tank system.

6-6. FUEL QUANTITY INDICATION SYSTEM.

The airplane incorporates a transistorized capacitance type fuel quantity gaging system with probes in all of the integral tanks. The external fuel tanks do not have a quantity indicating system. The pilot may manually select fuel quantity indications for left wing tanks, right wing tanks, fuselage tank or total of all integral fuel tanks. The wing tank indication includes the respective transfer tank when it contains fuel. All fuel quantity indications are calibrated in pounds. Power for the system is supplied

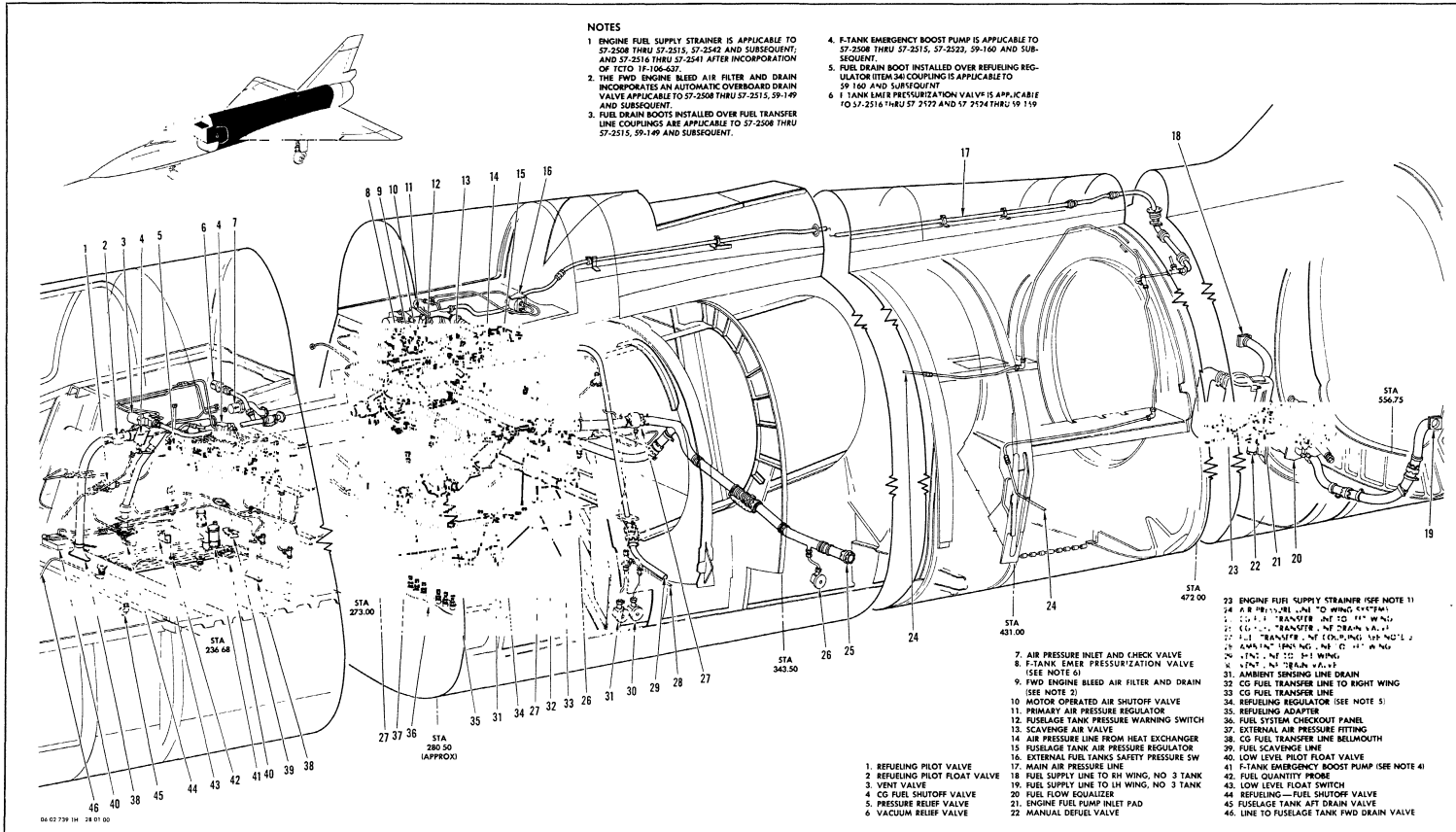

Figure 6-2. Location of Fuel Tanks and Components, F-106B (Sheet 1 of 2)

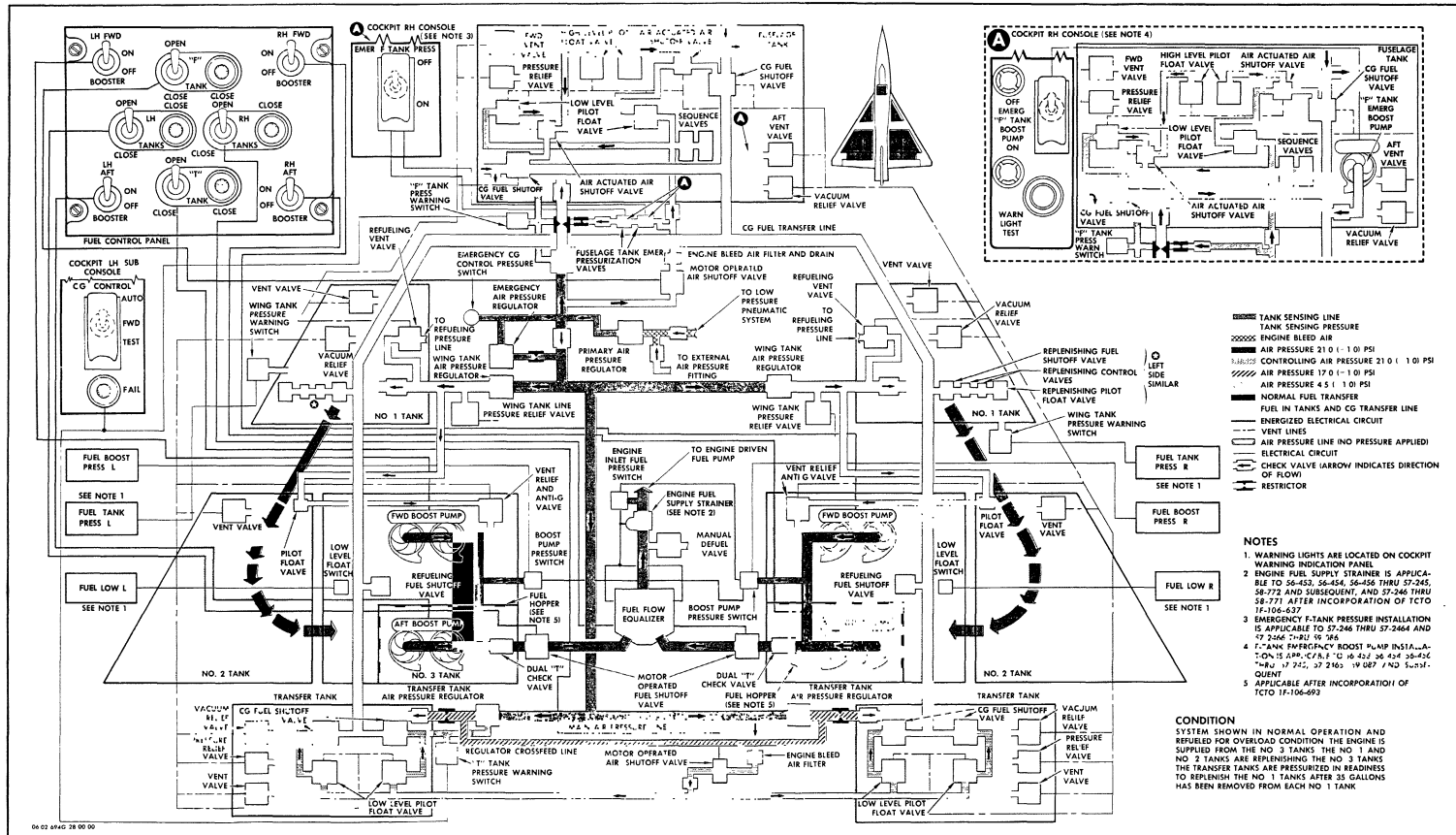
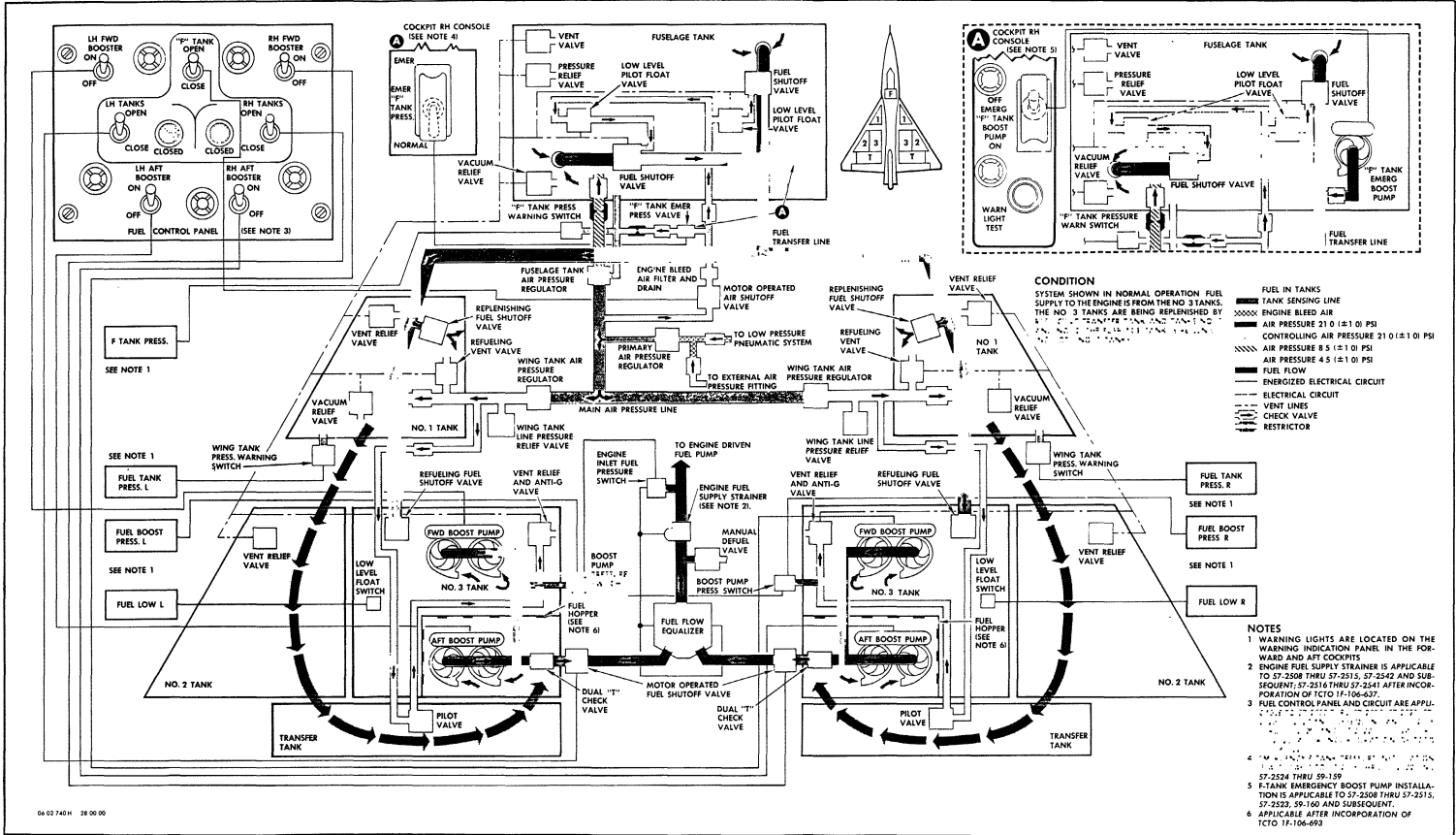

Figure 6-3. Fuel System Diagram, F-106A
 Applicable to 56-453, -454, 56-456 thru 57-245, 57-2453, 57-2456 and subsequent.
 Refer to T.O. 1F-106A-2-5 for other versions



06 02 740H 28 00 00

Figure 6-4. Fuel System Diagram, F-106B

from the 115-volt ac essential bus. This system is covered in detail in T.O. 1F-106A-2-9.

6-7. REFUELING.

The airplane is refueled through a single point refueling adapter, located at the lower right side of the engine inlet duct fairing. The refueling adapter is a standard bayonet lock-type fitting, containing an internal shutoff valve. This valve is open only when the refueling nozzle is

locked to the adapter. Refer to T.O. 1F-106A-2-5 for a complete procedure on refueling the F-106A and F-106B airplanes.

6-8. DEFUELING.

Defueling fuel flow is identical to the main system-to-engine fuel flow except that fuel is routed to a defuel truck through the manual defuel valve. T.O. 1F-106A-2-5 contains the complete procedure for defueling the F-106A and F-106B airplanes.

Section VII**AIR CONDITIONING, ANTI-ICING, AND OXYGEN SYSTEMS**

<i>Contents</i>	<i>Page</i>
Air Conditioning and Pressurization System	7-1
Anti-Icing and Defog Systems	7-7
Oxygen System	7-11

AIR CONDITIONING AND PRESSURIZATION SYSTEM

7-1. GENERAL.

The cockpit and the electronics compartments are supplied with engine bleed air cooled by passage through the refrigeration unit. The air directed to the cockpit and electronics compartments is temperature-regulated by the addition of hot (unrefrigerated) engine bleed air. Ram air for cockpit and electronics compartments ventilation is available at the pilot's option. The air conditioning and pressurization system is covered in detail in T.O. 1F-106A-2-6.

7-2. COCKPIT AIR CONDITIONING AND PRESSURIZATION.

The cockpit is normally supplied with temperature-regulated bleed air obtained from the N₂ compressor section of the airplane engine. Bleed air is conducted through the low pressure pneumatic system tubing to the heat exchanger where it is partially cooled. The air then passes through the pressure regulator-and-shutoff valve to the expansion turbine where the air is cooled by expansion. A compressor, mounted on a common shaft with the turbine, rotates with the expansion turbine. A portion of ram or ambient air is tapped from the engine inlet headers and drawn into the compressor. This air is compressed and discharged through jet pump nozzles downstream of the heat exchanger. The accelerated flow of compressed air creates a low pressure area downstream of the heat exchanger. This condition insures cooling air flow over the heat exchanger tubes when the ram air through the engine inlet headers is at a low velocity.

The refrigerated air is then delivered to the cockpit and the electronic compartments. The rate of flow of refrigerated air into the cockpit varies with the altitude of the airplane. Refrigerated air in excess of that required to cool the cockpit, is automatically conducted to the electronic compartments during normal flight operations. *Applicable to F-106A airplanes*, see figures 7-1 and 7-2 for perspective and schematic illustrations of the air conditioning and pressurization system. *Applicable to F-106B airplanes*, see figures 7-3 and 7-4 for perspective and schematic illustrations of the air conditioning and pressurization system.

7-3. COCKPIT LOW PRESSURE WARNING SYSTEM.

A low pressure warning system is installed in the cockpit to give warning of inadequate cockpit pressurization. The system consists of a pressure switch and a "CABIN PRESS LOW" warning light. A loss of cockpit pressure will cause the pressure switch vented diaphragm to contract. Mechanical linkage attached to the diaphragm completes the electrical circuit causing the "CABIN PRESS LOW" warning light to illuminate. The warning system receives 28-v dc power through the "CKPT PRESS WARN" fuse (cockpit RH fuse panel) on some airplanes; through the "CAB VENT AND PRESS WARN" fuse (NWW fuse panel) on other airplanes. Refer to T.O. 1F-106A-2-6 for complete coverage of this system.

**7-4. COCKPIT AND CANOPY EMERGENCY
SEAL PRESSURIZATION SYSTEM.**

The cockpit emergency pressurization system automatically maintains cockpit and canopy seal pressure in event of normal system failure at high altitude. This system is activated by the cockpit low pressure warning switch at the same time as the "CABIN PRESS LOW" warning light is illuminated. Refer to paragraph 7-3 for cockpit low pressure warning system operation. When the cockpit emergency pressurization system is activated, an emergency air pressure control valve is opened. This allows air from the high pressure pneumatic system (1500 psi manifold) to be metered to the canopy seal system and cockpit pressurization system. Restrictor orifices control the volume of air from the high pressure pneumatic system; flapper check valves prevent back flow into the normal system during emergency operation. The cockpit emergency pressurization will not operate when the cabin air switch is in "RAM" position. Prolonged emergency operation is not recommended due to the possibility of depleting high pressure air source for all systems using air pressure from the main system air flask. Refer to T.O. 1F-106A-2-6 for complete coverage of this system.

7-5. CANOPY SEAL SYSTEM.

The airplane canopy is sealed against loss of pressurization by an inflatable seal around the edges of the canopy. When the canopy is closed and locked, the seal will be inflated providing engine bleed air is available. Partially cooled engine bleed air is used to inflate the seal and is controlled by a canopy seal selector valve located in the air supply line to the seal. The selector valve is connected to the canopy latch mechanism. The valve opens when the canopy latching hooks are in the locked position to allow the low pressure air to inflate the seal. Relief and safety valves regulate seal pressure and prevent overpressurization. On airplanes equipped with cockpit emergency pressurization provisions, the canopy seal system receives air pressure from the high pressure pneumatic system in event of an emergency.

**7-6. ELECTRONIC COMPARTMENTS AIR
CONDITIONING AND PRESSURIZATION.**

The forward and aft electronics compartments and the IFF compartments are normally supplied with refrigerated air from the refrigeration unit. *Applicable to F-106A airplanes 57-246 thru 59-111, and F-106B airplanes 57-2516 thru 59-159*, the temperature of refrigerated air supplied to the electronic compartments is limited to -40°C (-40°F). A mechanical thermostat in the refrigeration turbine discharge duct bleeds control pressure to a pneumatic bypass valve. When open, the bypass valve adds sufficient hot bleed air to turbine inlet air to raise turbine

discharge temperatures above -40°C (-40°F). *Applicable to F-106A airplanes 56-453 thru 57-245, 59-112 and subsequent, and F-106B airplanes 57-2508 thru 57-2515, 59-160 and subsequent*, the temperature of refrigerated air is regulated to a low of -17.8°C (0°F) in the turbine discharge duct. *Applicable to 56-453, -454, 56-456 thru 57-245, 57-2454, -2472, 57-2474, 59-112 and subsequent; and 57-246 thru -2453, 57-2455 thru 57-2471, 57-2473, 57-2475 thru 59-111 after incorporation of TCTO 1F-106-641 and -641A. Applicable to F-106B airplanes 57-2508 thru -2515, 57-2528, 59-160 and subsequent; and 57-2516 thru -2527, 57-2529 thru 59-159 after incorporation of TCTO 1F-106-641.* A second thermostat, in the electronics cooling ducting, regulates another hot air shutoff valve and maintains air temperature in the electronics cooling ducting at a temperature of $+10.0^{\circ}\text{C}$ ($+50^{\circ}\text{F}$). *On all airplanes during flight condition*, ram air is used for electronic compartment cooling in event the refrigeration switch is placed in OFF position. *Applicable to all airplanes*, air conducted to the forward electronic compartment discharges into the nose wheel well, after passing through the compartment, and mixes with air discharged from the cockpit. If the nose wheel well door is closed, the air mixture flows aft into the aft electronics compartment where it aids in compartment cooling. If the nose wheel well door is open, the air mixture is discharged overboard. *Applicable to F-106B airplanes 57-2516 thru 57-2522.* Air pressure in the electronic compartments is regulated by two outflow valves and a control head mounted in the aft bulkhead of the aft electronic compartment. The control head senses compartment pressure, and regulates the outflow valves to control the rate of flow through the valves. The pressure in the electronic compartments is thus regulated to maintain a maximum pressure differential of approximately 1.4 psi above ambient. *Applicable to all F-106A airplanes, and F-106B airplanes 57-2508 thru -2515, 57-2523 and subsequent*, two flapper type check valves allow conditioned air to purge the area around the fuselage tank and missile bay. The check valves prevent back flow of contaminated air from the fuselage tank area. *Applicable to all airplanes*, air flows from the aft electronics compartment into the area around the fuselage fuel tank. Some of this air enters the missile bay, and flows overboard through the fuselage purge vents. The remainder of the air flows aft to the hydraulic accessories compartment where it is discharged overboard. In addition to cooling the compartment this flow of air also prevents the accumulation of dangerous fuel vapors in the fuselage tank area. During normal ground operation with engine operating, the flow of conditioned air to the electronic compartments is diverted by simultaneous operation of two shutoff valves. The valves insure proper cooling of the essential communications equipment during low engine rpm. Refer to T.O. 1F-106A-2-6 for complete coverage of this system.

7-6A. *Applicable to F-106A airplanes 56-453, 56-454, 56-456 thru 57-245, 57-2453; and 57-246, 57-2454 and subsequent after incorporation of TCTO 1F-106-621. Applicable to F-106B airplanes 57-2508 thru 57-2515 and 57-2517; and 57-2516, 57-2518 and subsequent after incorporation of TCTO 1F-106-621.* The bleed air ejector system provides increased boundary layer ram airflow across

the heat exchanger during ground operation when the engine is operating at idle rpm. The increased ram airflow lowers the temperature of refrigerated air delivered to the electronics compartment, permitting continuous operation of electronic equipment when ambient temperatures do not exceed 39.4°C (103°F). When engine bleed air (N₂) pressure exceeds 35 psig, the bleed air ejector system is deactivated as it is no longer required.

NOTES

1. ADJUSTABLE (EYEBALL TYPE) AIR OUTLETS AND TUBING ARE INSTALLED IN 57-246 THRU 57-2464, 57-2466 THRU 57-2506.
2. THE ELECTRONIC COOLING HOT AIR BYPASS SYSTEM IS APPLICABLE TO 56-453, -454, 56-456 THRU 57-245, 57-2454, 57-2475, 57-2476, 59-112 AND SUBSEQUENT, AND 57-246 THRU -2453, 57-2455 THRU 57-2471, 57-2473, 57-2475 THRU 59-111 AFTER INCORPORATION OF TC TO 1F-106-441 AND -441A.
3. THE ELECTRONICS COOLING OVERHEAT WARNING (ELECTRONICS BTU SENSOR) SYSTEM IS APPLICABLE TO 56-453, -454, 56-456 THRU 57-245, -2454, -2465, 57-2478 AND SUBSEQUENT, AND 57-246 THRU -2453, -2455 THRU -2464, -2466 THRU 57-2477 AFTER INCORPORATION OF TC TO 1F-106-649.
4. BLEED AIR EJECTOR SYSTEM IS APPLICABLE TO 56-453, 56-454, 56-456 THRU 57-245, AND 57-2452, AND 57-246, 57-2454 AND SUBSEQUENT AFTER INCORPORATION OF TC TO 1F-106-621.

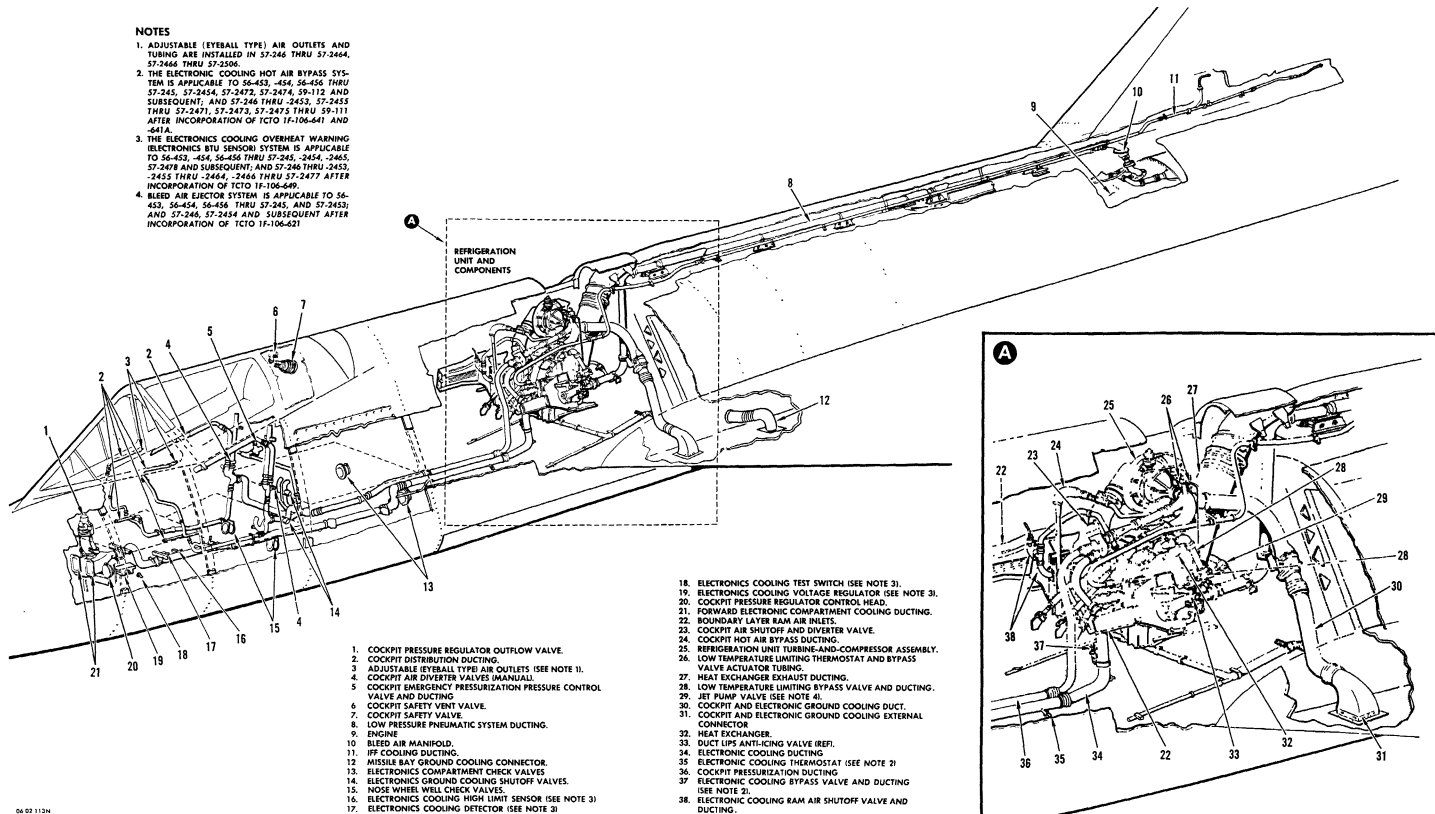

1. COCKPIT PRESSURE REGULATOR OUTFLOW VALVE.
2. COCKPIT DISTRIBUTION DUCTING.
3. ADJUSTABLE (EYEBALL TYPE) AIR OUTLETS (SEE NOTE 1).
4. COCKPIT AIR DIVERTER VALVES (MANUAL).
5. COCKPIT EMERGENCY PRESSURIZATION PRESSURE CONTROL VALVE AND DUCTING.
6. COCKPIT SAFETY VENT VALVE.
7. COCKPIT SAFETY VALVE.
8. LOW PRESSURE PNEUMATIC SYSTEM DUCTING.
9. ENGINE.
10. BLEED AIR MANIFOLD.
11. IFF COOLING DUCTING.
12. INFLATOR BAY GROUND COOLING CONNECTOR.
13. ELECTRONICS COMPARTMENT CHECK VALVES.
14. ELECTRONICS GROUND COOLING SHUTOFF VALVES.
15. NOSE WHEEL WELL CHECK VALVES.
16. ELECTRONICS COOLING HIGH LIMIT SENSOR (SEE NOTE 3).
17. ELECTRONICS COOLING DETECTOR (SEE NOTE 3).

18. ELECTRONICS COOLING TEST SWITCH (SEE NOTE 3).
19. ELECTRONICS COOLING VOLTAGE REGULATOR (SEE NOTE 3).
20. COCKPIT PRESSURE REGULATOR CONTROL HEAD.
21. FORWARD ELECTRONIC COMPARTMENT COOLING DUCTING.
22. BOUNDARY LAYER RAM AIR INLETS.
23. COCKPIT AIR SHUTOFF AND DIVERTER VALVE.
24. COCKPIT HOT AIR BYPASS DUCTING.
25. REFRIGERATION UNIT TURBINE-AND-COMPRESSOR ASSEMBLY.
26. LOW TEMPERATURE LIMITING THERMOSTAT AND BYPASS VALVE ACTUATOR TUBING.
27. HEAT EXCHANGER EXHAUST DUCTING.
28. LOW TEMPERATURE LIMITING BYPASS VALVE AND DUCTING.
29. JET RAMP VALVE (SEE NOTE 4).
30. COCKPIT AND ELECTRONIC GROUND COOLING DUCT.
31. COCKPIT AND ELECTRONIC GROUND COOLING EXTERNAL CONNECTOR.
32. HEAT EXCHANGER.
33. DUCT LIPS ANTI-ICING VALVE (REF).
34. ELECTRONIC COOLING DUCTING.
35. ELECTRONIC COOLING THERMOSTAT (SEE NOTE 2).
36. COCKPIT PRESSURIZATION DUCTING.
37. ELECTRONIC COOLING BYPASS VALVE AND DUCTING (SEE NOTE 2).
38. ELECTRONIC COOLING RAM AIR SHUTOFF VALVE AND DUCTING.

Figure 7-1. Air Conditioning and Pressurization System, F-106A

CONDITION
AIRPLANE SHOWN IN NORMAL,
IN-FLIGHT CONDITION

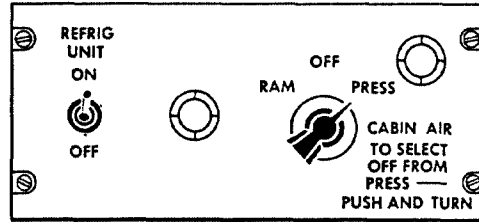

COCKPIT AIR CONTROL PANEL

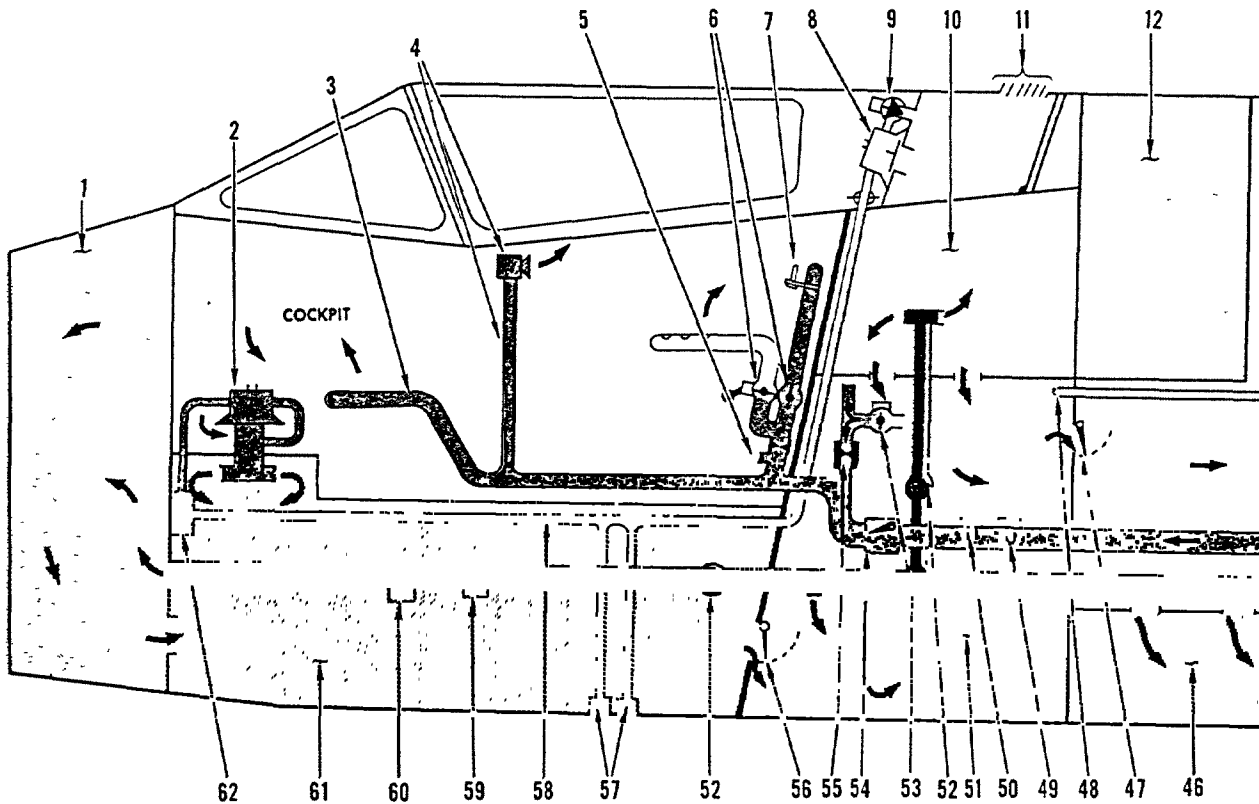

1. FORWARD ELECTRONICS COMPARTMENT
2. COCKPIT PRESSURE REGULATOR OUTFLOW VALVE (PNEUMATIC)
3. COCKPIT AIR DISTRIBUTION DUCTS
4. ADJUSTABLE EYEBALL OUTLET AND DUCTING (SEE NOTE 3)
5. PILOT'S VENT SUIT CONNECTION
6. COCKPIT AIR DIVERTER VALVE (MANUAL)
7. COCKPIT TEMPERATURE SENSOR (REF) (SEE NOTE 1)
8. COCKPIT AIR SAFETY VALVE (PNEUMATIC)
9. COCKPIT SAFETY VENT VALVE (ELECTRICAL)
10. UPPER AFT ELECTRONICS COMPARTMENT
11. DUMP LOUVERS
12. FUSELAGE FUEL TANK (REF)
13. COCKPIT AIR SHUTOFF-AND-DIVERTER VALVE (ELECTRICAL)
14. AIR FLOW SENSOR

15. AIR CONDITIONING COMPARTMENT
16. ELECTRONIC COOLING RAM AIR VALVE
17. FLOW CONTROL VALVE (PNEUMATIC)
18. ACTUATOR TUBING, LOW TEMPERATURE LIMITING BYPASS VALVE
19. LOW TEMPERATURE LIMITING THERMOSTAT
20. REFRIGERATION UNIT PRESSURE REGULATOR-AND-SHUTOFF VALVE (ELECTRICAL-PNEUMATIC)
21. REFRIGERATION UNIT TURBINE-AND-COMPRESSOR ASSEMBLY
22. HEAT EXCHANGER, COOLING AIR EXHAUST
23. FUME-TIGHT BULKHEAD (REF)
24. LOW PRESSURE PNEUMATIC SYSTEM DUCT
25. ENGINE N₁ COMPRESSOR SECTION
26. IFF COMPARTMENT
27. ENGINE N₂ COMPRESSOR SECTION
28. MAIN WHEEL WELL (REF)

.06 02 035 1H 21 00 00

Figure 7-2. Air Conditioning and Pressurization System Schematic, F-106A (Sheet 1 of 2)

- BLEED AIR (HOT)
- ▨ COOLED BLEED AIR
- REFRIGERATED AIR
- RAM AIR
- TEMPERATURE-REGULATED AIR
- ▨ COMPRESSOR DISCHARGE AIR
- PURGE AIR FLOW

NOTES

1. THE COCKPIT TEMPERATURE SENSOR INSTALLATION ON THE RIGHT-HAND VERTICAL PICCOLO TUBE IS APPLICABLE TO 57-246 THRU 59-111.
2. THE BTU SENSOR INSTALLATION IS APPLICABLE TO 56-453, -454, 56-456 THRU 57-245, -2454, -2465, 57-2478 AND SUBSEQUENT; AND 57-246 THRU -2453, 2455 THRU -2464, -2466 THRU 57-2477 AFTER INCORPORATION OF TCTO 1F-106-649.
3. ADJUSTABLE (EYEBALL TYPE) AIR OUTLETS AND TUBING ARE APPLICABLE TO 57-246 THRU -2464, -2466 THRU 57-2506.
4. THE COCKPIT TEMPERATURE ANTICIPATOR SENSOR IS APPLICABLE TO 57-246 THRU 59-111.
5. THE ELECTRONICS COOLING HOT AIR BYPASS SYSTEM IS APPLICABLE TO 56-453, -454, 56-456 THRU 57-245, 57-2454, 57-2472, 57-2474, 59-112 AND SUBSEQUENT; AND 57-246 THRU -2453, 57-2455 THRU 57-2471, 57-2473, 57-2475 THRU 59-111 AFTER INCORPORATION OF TCTO 1F-106-641 AND -641A
6. BLEED AIR EJECTOR SYSTEM IS APPLICABLE TO 56-453, 56-454, 56-456 THRU 57-245, AND 57-2453; AND 57-246, 57-2454 AND SUBSEQUENT AFTER INCORPORATION OF TCTO 1F-106-621.

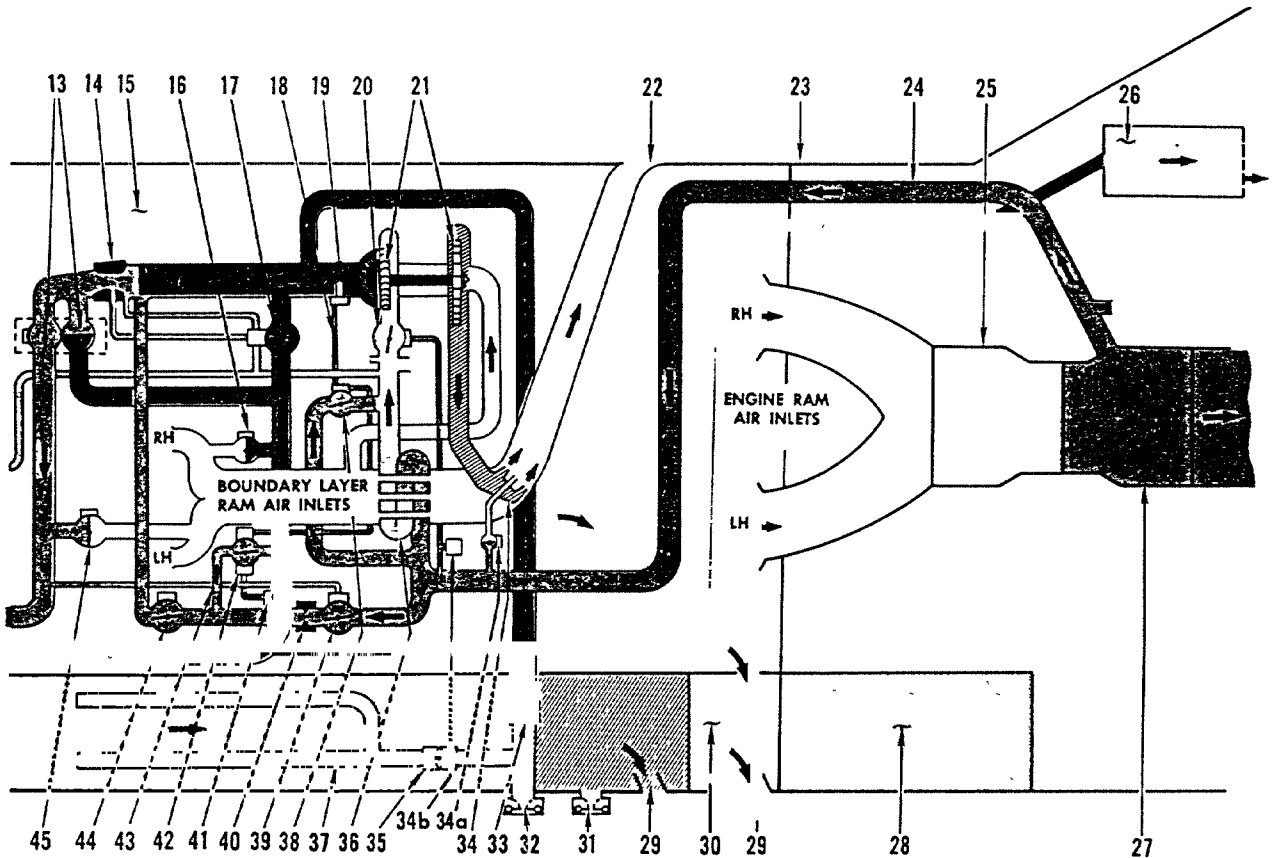

- 29. FUSELAGE PURGE VENTS
- 30. HYDRAULICS ACCESSORY COMPARTMENT
- 31. MISSILE BAY GROUND COOLING CONNECTION
- 32. COCKPIT AND ELECTRONICS COMPARTMENTS GROUND COOLING CONNECTION
- 33. GROUND COOLING CHECK VALVE
- 34. HEAT EXCHANGER COOLING AIR JET NOZZLES
- 34a. JET PUMP VALVE (ELECTRICAL-PNEUMATIC; SEE NOTE 6)
- 34b. BLEED AIR EJECTOR SYSTEM PRESSURE SWITCH (ELECTRICAL-PNEUMATIC; SEE NOTE 6)
- 35. MISSILE BAY GROUND CONDITIONING VALVE
- 36. HEAT EXCHANGER
- 37. MISSILE BAY GROUND COOLING AIR DISTRIBUTION DUCTING
- 38. LOW TEMPERATURE LIMITING BYPASS VALVE
- 39. BYPASS AIR PRESSURE REGULATOR-AND-SHUTOFF VALVE (ELECTRICAL-PNEUMATIC)
- 40. RESTRICTOR ORIFICE
- 41. ELECTRONIC COOLING THERMOSTAT (SEE NOTE 5)
- 42. ELECTRONIC COOLING BYPASS VALVE (SEE NOTE 5)
- 43. ELECTRONIC COOLING BYPASS DUCTING (SEE NOTE 5)

- 44. COCKPIT TEMPERATURE CONTROL VALVE (ELECTRICAL)
- 45. COCKPIT RAM AIR VALVE (ELECTRICAL)
- 46. MISSILE BAY
- 47. ELECTRONICS COMPARTMENT CHECK VALVES (2)
- 48. TO "G" SUIT REGULATOR (REF)
- 49. COCKPIT TEMPERATURE ANTICIPATOR SENSOR (REF) (SEE NOTE 4)
- 50. COCKPIT TEMPERATURE HIGH LIMIT SENSOR (REF)
- 51. LOWER AFT ELECTRONICS COMPARTMENT
- 52. ELECTRONICS COOLING VALVES
- 53. EMERGENCY AIR PRESSURE CONTROL VALVE
- 54. COCKPIT AIR CHECK VALVE
- 55. RESTRICTOR ORIFICE
- 56. ELECTRONICS COMPARTMENT CHECK VALVES (2)
- 57. STATIC PRESSURE SENSING PORTS (2)
- 58. STATIC PRESSURE SENSING LINE
- 59. ELECTRONICS COOLING BTU SENSOR (SEE NOTE 2)
- 60. ELECTRONICS COOLING BTU SENSOR CONTROL (SEE NOTE 2)
- 61. NOSE WHEEL WELL
- 62. COCKPIT PRESSURE REGULATOR CONTROL HEAD

04 02 035-24

Figure 7-2. Air Conditioning and Pressurization System Schematic, F-106A (Sheet 2 of 2)

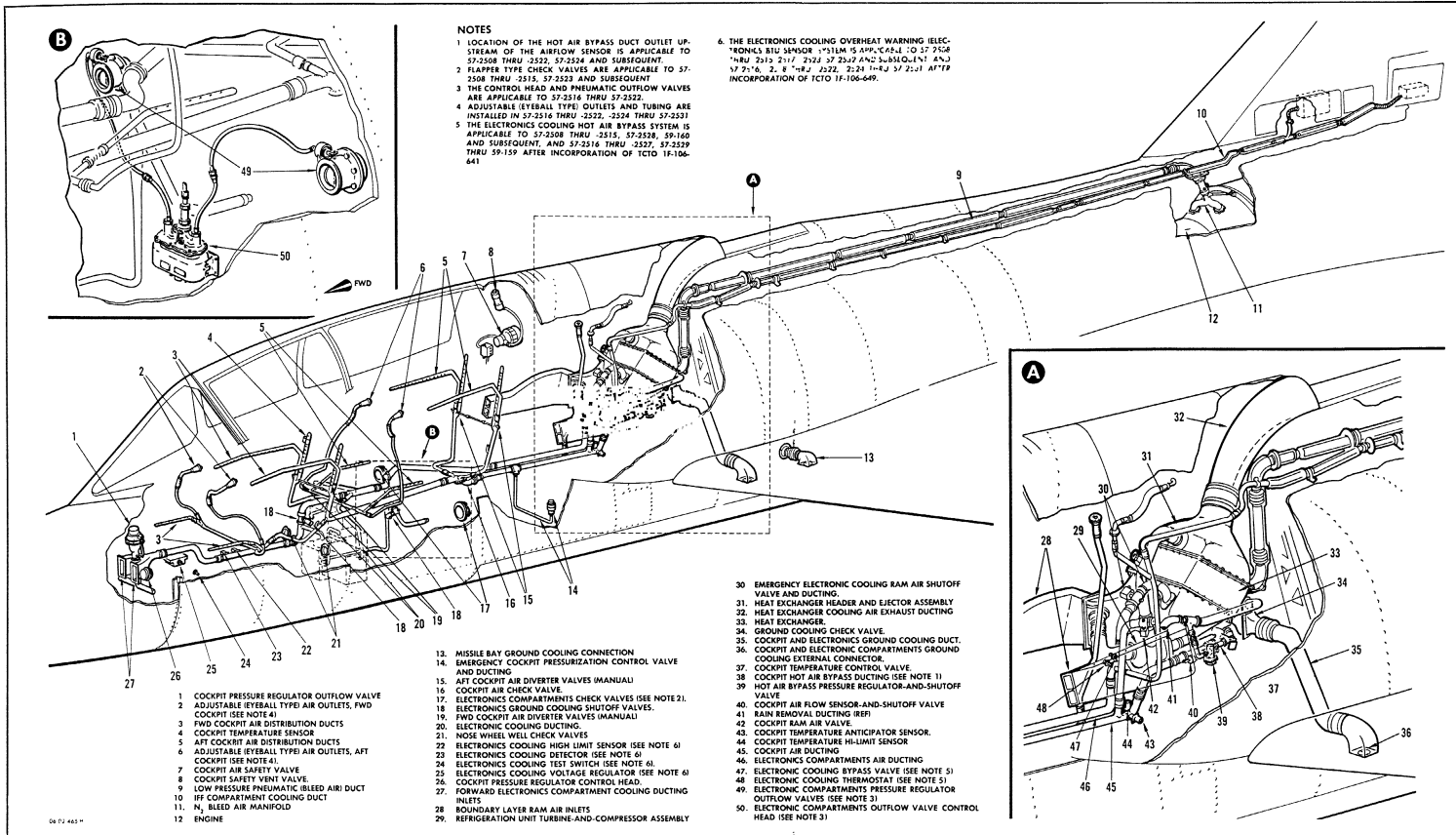

Figure 7-3. Air Conditioning and Pressurization System, F-106B

- █ BLEED AIR (HOT)
- ▨ COOLED BLEED AIR
- ▩ REFRIGERATED AIR
- ▧ RAM AIR
- ▦ COMPRESSOR DISCHARGE AIR
- ▥ TEMPERATURE-REGULATED AIR
- PURGE AIR FLOW

NOTES

- 1 THE COCKPIT TEMPERATURE SENSOR INSTALLATION ON THE RIGHT VERTICAL PICCOLO TUBE IS APPLICABLE TO 57-2516 THRU 59-159.
- 2 FLAPPER TYPE CHECK VALVES ARE APPLICABLE TO 57-2508 THRU -2515, 57-2523 AND SUBSEQUENT.

- 3 THE BTU SENSOR INSTALLATION IS APPLICABLE TO 57-2508 THRU -2515, -2517, -2523, 57-2532 AND SUBSEQUENT; AND 57-2516, -2518 THRU -2522, -2524 THRU 57-2531 AFTER INCORPORATION OF TCTO 1F-106-649
- 4 ADJUSTABLE (EYEBALL TYPE) OUTLETS AND TUBING ARE APPLICABLE TO 57-2516 THRU -2522, -2524 THRU 57-2531.
- 5 LOCATION OF THE HOT AIR BYPASS DUCT UPSTREAM OF THE AIRFLOW SENSOR IS APPLICABLE TO 57-2508 THRU -2522, 57-2524 AND SUBSEQUENT.
- 6 THE COCKPIT TEMPERATURE ANTICIPATOR SENSOR IS APPLICABLE TO 57-2516 THRU 59-159.
- 7 THE ELECTRONICS COOLING HOT AIR BYPASS SYSTEM IS APPLICABLE TO 57-2508 THRU -2515, 57-2528, 59-160 AND SUBSEQUENT, AND 57-2516 THRU -2527, 57-2529 THRU 59-159, AFTER INCORPORATION OF TCTO 1F-106-641.
- 8 BLEED AIR EJECTOR SYSTEM IS APPLICABLE TO 57-2508 THRU 57-2515, AND 57-2517; AND 57-2516, 57-2518 AND SUBSEQUENT AFTER INCORPORATION OF TCTO 1F-106-621

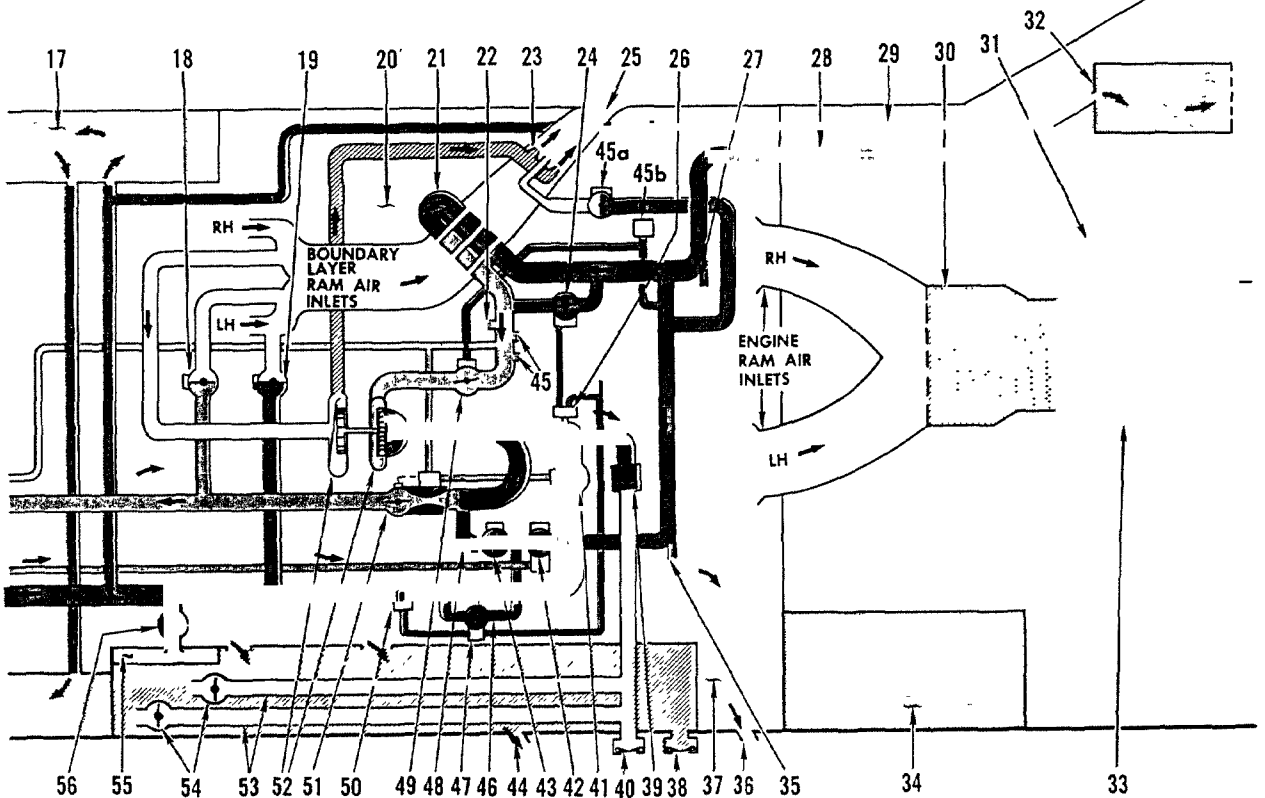

- | | |
|--|---|
| <ol style="list-style-type: none"> 41 FLOW CONTROL VALVE (PNEUMATIC). 42 BYPASS AIR PRESSURE REGULATOR-AND-SHUTOFF VALVE (ELECTRIC-PNEUMATIC) 43 COCKPIT TEMPERATURE CONTROL VALVE (ELECTRIC). 44 MISSILE BAY PURGE VENT 45 FUEL SYSTEM PRESSURIZATION AND RADOME ANTI-ICE FLUID TANK PRESSURIZATION CONNECTIONS. 45a JET PUMP VALVE (ELECTRIC-PNEUMATIC; SEE NOTE 8). 45b BLEED AIR EJECTOR SYSTEM PRESSURE SWITCH (ELECTRIC-PNEUMATIC; SEE NOTE 8). 46 ELECTRONIC COOLING BYPASS DUCTING (SEE NOTE 7) 47 ELECTRONIC COOLING BYPASS VALVE (SEE NOTE 7). 48 COCKPIT HOT AIR BYPASS DUCTING (SEE NOTE 5) 49 REFRIGERATION UNIT PRESSURE REGULATOR-AND-SHUTOFF VALVE (ELECTRIC-PNEUMATIC). 50 ELECTRONIC COOLING THERMOSTAT (SEE NOTE 7). 51 COCKPIT AIRFLOW SENSOR AND SHUTOFF VALVE (ELECTRIC-PNEUMATIC). 52 REFRIGERATION UNIT TURBINE-AND-COMPRESSOR ASSEMBLY 53 MISSILE BAY COOLING AIR DISTRIBUTION DUCTING. 54 MISSILE BAY GROUND CONDITIONING VALVES (2 EACH). 55 LOWER AFT ELECTRONICS COMPARTMENT 56 AFT ELECTRONICS COOLING VALVE 57 COCKPIT AIR DUCT. | <ol style="list-style-type: none"> 58 COCKPIT AIR CHECK VALVE 59 FROM HIGH PRESSURE PNEUMATIC SYSTEM 60 EMERGENCY COCKPIT PRESSURIZATION CONTROL VALVE (ELECTRIC-PNEUMATIC) 61 TO CANOPY SEAL SYSTEM 62 PILOT'S "G" SUIT PRESSURE REGULATOR (REF). 63 CHECK VALVES (SEE NOTE 2) 64 TO RADOME ANTI-ICE SYSTEM. 65 ELECTRONIC COOLING AIR DUCT. 66 LOWER MID ELECTRONIC COMPARTMENT 67 FWD ELECTRONICS COOLING VALVE. 68 ELECTRONIC COMPARTMENT CHECK VALVES (2 EA) 69. STATIC PRESSURE SENSING PORTS (2 EA) 70. CANOPY SEAL TEST FITTING 71. CABIN PRESSURE TEST FITTINGS (2 EA). 72. ELECTRONICS COOLING BTU SENSOR (SEE NOTE 3) 73. ELECTRONICS COOLING BTU SENSOR CONTROL (SEE NOTE 3) 74. NOSE WHEEL WELL. 75. COCKPIT PRESSURE REGULATOR CONTROL HEAD 76 ELECTRONIC COMPARTMENTS PRESSURE REGULATOR OUTFLOW VALVES (2 EA. PNEUMATIC; SEE NOTE 2). 77 ELECTRONIC COMPARTMENTS PRESSURE REGULATOR CONTROL HEAD (SEE NOTE 2) |
|--|---|

06 02 464-2K

Figure 7-4. Air Conditioning and Pressurization System Schematic, F-106B (Sheet 2 of 2)

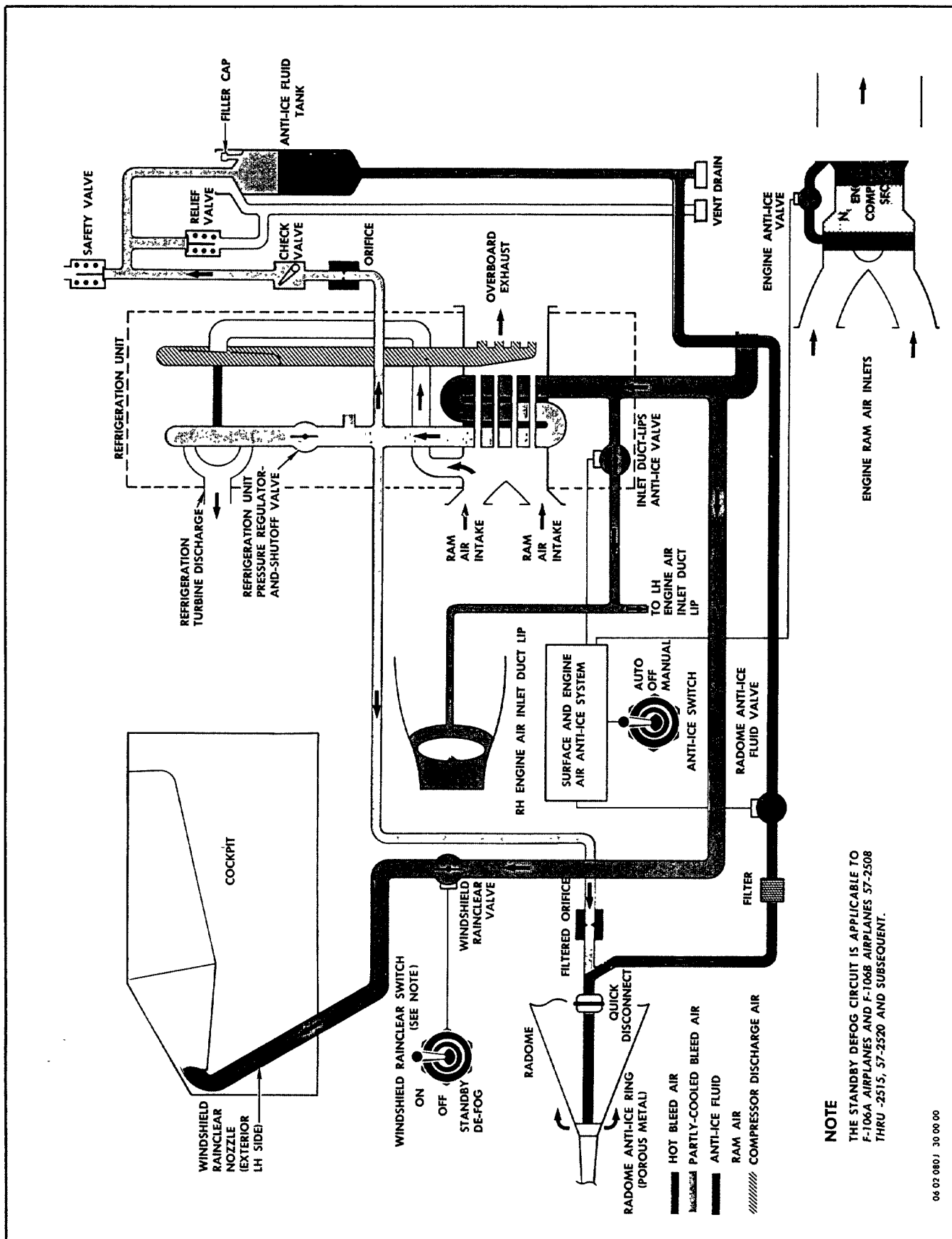

Figure 7-5. Anti-Icing and De-Fog Systems Using Bleed Air

7-14. RADOME ANTI-ICE SYSTEM.

The exterior surfaces of the radome are protected against ice formation by anti-icing fluid from the anti-ice fluid tank, located in the refrigeration compartment. The fluid is forced through a porous metal ring at the base of the pitot static boom. The airstream distributes the fluid evenly over the surface of the radome to form an anti-icing film. Operation of the radome anti-ice system is controlled by the surface and engine anti-ice system discussed in T.O. 1F-106A-2-6. Power for the radome anti-ice system is connected from the 28-volt dc "RADOME ANTI-ICE" fuse on the main wheel well fuse panel.

7-15. WINDSHIELD RAINCLEARING SYSTEM.

The windshield rainclearing system uses hot bleed air tapped from the low pressure pneumatic system duct near the refrigeration unit. The system forms a layer of hot air across the exterior surfaces of the left windshield panel that prevents rain from reaching the panel. Power for the windshield rainclearing system is connected from the 28-volt dc "RAIN REMOVAL" fuse on the cockpit left fuse panel. Refer to T.O. 1F-106A-2-6 for information regarding this system.

7-16. WINDSHIELD ELECTRICAL ANTI-ICE, ANTI-FOG SYSTEM.

The windshield panels are equipped with a conductive coating imbedded between the inner and outer layers of glass. Electrical current passing through the coating prevents the formation of ice and mist on the windshield. This system receives power from the 115/200-v ac non-essential bus through four "WINDSHIELD ANTI-ICE," "ANTI-FOG" fuses. Refer to T.O. 1F-106A-2-6 for complete description of this system. *Applicable to all F-106A airplanes and F-106B airplanes 57-2508 thru -2515, 57-2520 and subsequent*, the entire left and right windshield panels are anti-iced and anti-fogged electrically. *Applicable to F-106B airplanes 57-2516 thru 57-2519*, only the

aft two-thirds of the left and right windshield panels are electrically anti-iced.

7-17. CANOPY ELECTRICAL ANTI-FOG SYSTEM.

The canopy anti-fog system prevents formation of mist on the inner surface of the canopy panels. This is accomplished by electrical current passing through conductive coatings imbedded between the inner and outer layers of the transparent plastic canopy panels. The canopy anti-fog system should be turned on at least two minutes prior to takeoff or landing. The system receives electrical power from the 115-v ac nonessential bus through "CANOPY ANTI-FOG" fuses. Refer to T.O. 1F-106A-2-6 for complete description and operation of this system.

7-18. PITOT-STATIC TUBE ANTI-ICE SYSTEM.

The pitot-static tube on the nose boom and the two pitot-static tubes in the engine inlet ducts are anti-iced by electrical heating elements. These elements are manually controlled by the "PITOT HEAT" switch in the cockpit. Electrical power for the nose boom pitot-static element is taken from the 115-v ac essential bus through the "PITOT HEATER" fuse. The two variable ramp pitot-static elements receive electrical power from the 115-v ac nonessential bus through the LH and RH "VAR INLET PITOT HEATER" fuses on the cockpit right fuse panels. Refer to T.O. 1F-106A-2-6 for complete description and operation of this system.

7-19. PILOT'S OXYGEN MASK DEFOG SYSTEM.

The pilot's oxygen mask is equipped with a clear plastic face plate containing electrical heating elements. These elements receive power from the 28-v dc essential bus through the "MASK DEFOG" fuse on the cockpit left fuse panel. The elements are controlled by a rheostat knob on the left console. *Applicable to F-106B airplanes*, the forward and aft cockpits are furnished with identical systems. Refer to T.O. 1F-106A-2-6 for description and operation of this system.

OXYGEN SYSTEM

7-20. GENERAL.

Applicable to airplanes equipped with the upward ejection seat. A low pressure (70 psi) liquid oxygen supply system supplies the pilot with gaseous breathing oxygen. The supply system consists of a vacuum insulated converter, a filler valve, a buildup-and-vent valve and the necessary plumbing. Various external attachments to the converter are: relief valves, pressure opening and pressure closing valves, evaporating coils, and a differential check valve. Liquid oxygen is metered by demand into

the evaporating coils where it evaporates at an expansion ratio of one part liquid to about 860 parts gas (by volume). The supply will last for 6 to 25 hours of continuous use, depending on the flight altitude. When not in use, the liquid will evaporate, or boil off, and be vented overboard automatically at a maximum rate of one liter per day. The oxygen system supplies the pilot with 100% oxygen at all times. The pilot's seat contains a survival kit incorporating components of the oxygen system. F-106B airplanes have a kit installed in both the forward and aft

seats. These components include a pressure regulator, a press-to-test button, two 25-cubic inch gaseous-oxygen emergency-supply cylinders, a pressure gage, a filler valve, and a shutoff valve. A control panel, on the cockpit left console, contains a liquid quantity gage, a gaseous-pressure gage and an "on-off" valve. An oxygen supply hose, from the control panel, connects to the survival kit through a disconnect fitting at the bottom of the kit. The "PRESS TO TEST" button, located on the right forward side of the survival kit, tests proper operation of the oxygen regulator. The pilot is automatically supplied with oxygen from the emergency supply cylinders during bailout. A "green apple" control, on the personal leads bundle, allows the pilot to manually turn on the emergency supply in case of normal system failure. A shuttle type check valve prevents the emergency system from bleeding into the normal system. The emergency cylinders contain sufficient oxygen for 10 to 15 minutes of continuous use. For further information on the survival kit, refer to T.O. 1F-106A-2-2. The oxygen converter assembly consists of a vacuum-insulated container, pressure closing and pressure opening valves, two relief valves, an integral capacitance probe, a build-up coil and a supply coil. These airplanes are equipped with an electric, capacitance type quantity gaging system. A survival kit, as described in paragraph 3-16, is installed in the pilot's seat. *F-106B airplanes* have a survival kit installed in both forward and aft seats. *All F-106A airplanes* are equipped with a 5-liter converter. A large container, installed in *F-106B airplanes*, has a 10-liter capacity. *Applicable to F-106A airplanes 57-2478 thru 58-798, and F-106B airplanes 57-2527 thru 58-904*, a dual oxygen system is installed. *Applicable to F-106A airplanes 58-759 thru 58-798, and F-106B airplanes 57-2532 thru 58-904*, components of the dual oxygen system are installed but the diluter-demand system is deactivated. *Applicable to F-106A airplanes 57-2478 thru 57-2506 and F-106B airplanes 57-2527 thru 57-2531*, optional outlets allow the pilot use of a pressure demand or diluter demand oxygen regulator. A single supply system provides gaseous oxygen for either regulator. The diluter-demand oxygen regulator is installed in a control panel mounted on the cockpit left console. *In F-106B airplanes*, the control

panel is installed in the forward and aft cockpit. On all airplanes equipped with the diluter demand regulator, oxygen outlets for the pilot's mask are attached to the right side of the ejection seat. This system is intended for use with the oxygen mask only. If the airplane is to be flown at higher altitudes, or if the pilot is equipped with a pressure suit and helmet, the pressure demand regulator in the survival kit is utilized. The electric, capacitance type, quantity gage is mounted outboard of the cockpit left console. A quantity gage is installed in the forward cockpit only in *F-106B airplanes*. A direct reading, differential type, pressure gage is mounted on the diluter-demand control panel on the cockpit left console. *On F-106B airplanes*, both the forward and aft cockpits are provided with pressure gages. A control lever for the pressure demand system is located on the forward end of the left subconsoles. All controls for the diluter-demand system are located on the left main consoles. Refer to T.O. 1F-106A-2-6 for complete coverage of the oxygen system. See figures 7-6 and 7-7 for schematic illustrations of the liquid oxygen supply system.

7-21. *Applicable to airplanes equipped with the rotational upward ejection seat.* The oxygen equipment on these airplanes is identical to that described in paragraph 7-20, except the equipment is contained in the ejection seat instead of the survival kit. Operation of the system is the same except that during bailout, the entire seat, rather than the survival kit remains attached to the pilot. At an altitude of approximately 15,000 feet, where further descent without oxygen is safe, the seat with the oxygen equipment separates from the pilot and the pilot breathes ambient air.

7-22. LIQUID OXYGEN.

Liquid oxygen is an extremely cold, colorless liquid. When exposed, the liquid turns slightly blue. Liquid oxygen is supplied at a temperature of approximately -184°C (-299°F). Because of this extreme temperature, liquid oxygen is very dangerous and must be handled with care. When working with liquid oxygen, observe all safety precautions outlined in T. O. 1F-106A-2-6.

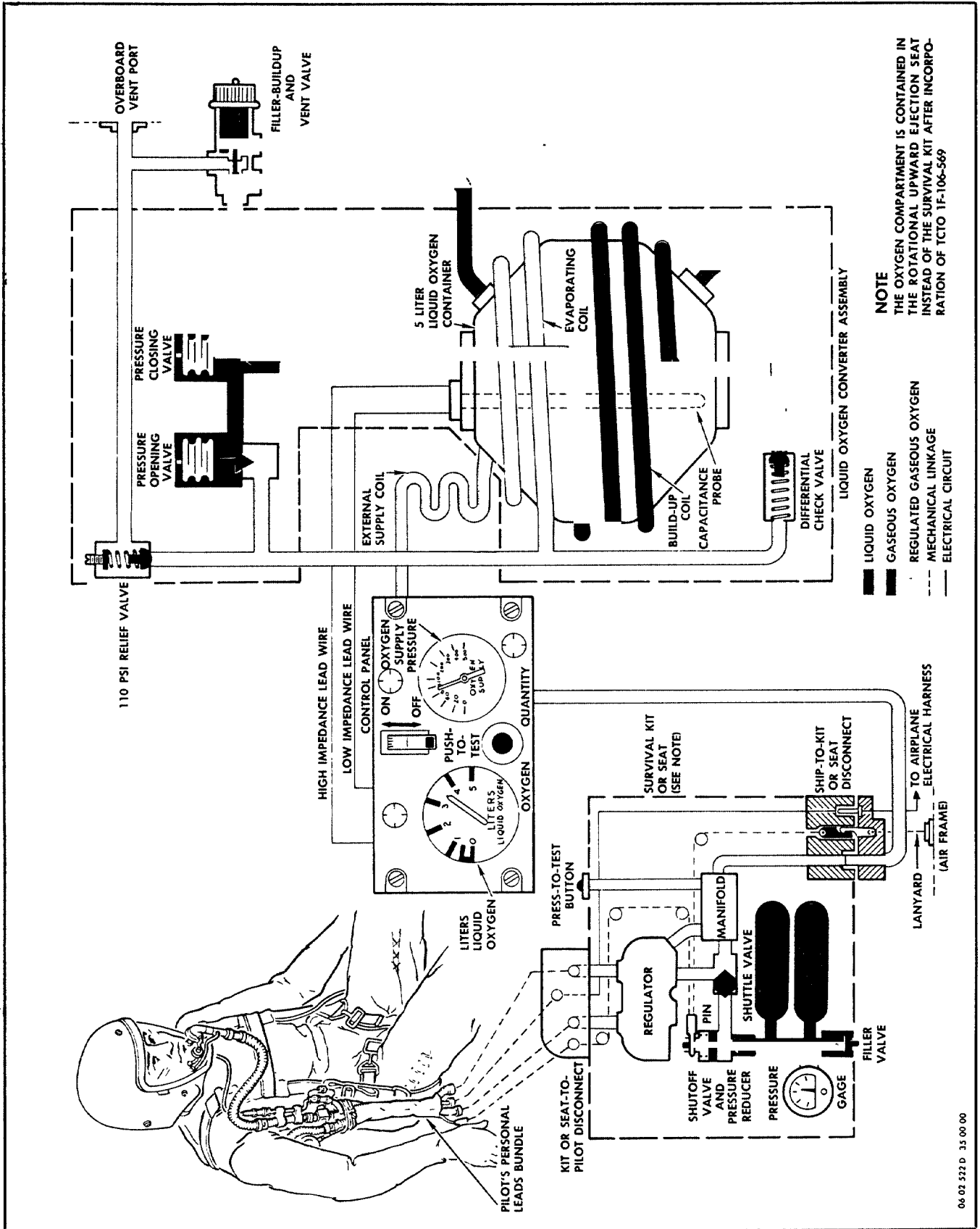

Figure 7-6. Liquid Oxygen Supply System Schematic, F-106A
 Applicable to 56-453, -454, 56-456 thru 57-2477, 59-001 and subsequent.
 Refer to T. O. 1F-106A-2-6 for other versions

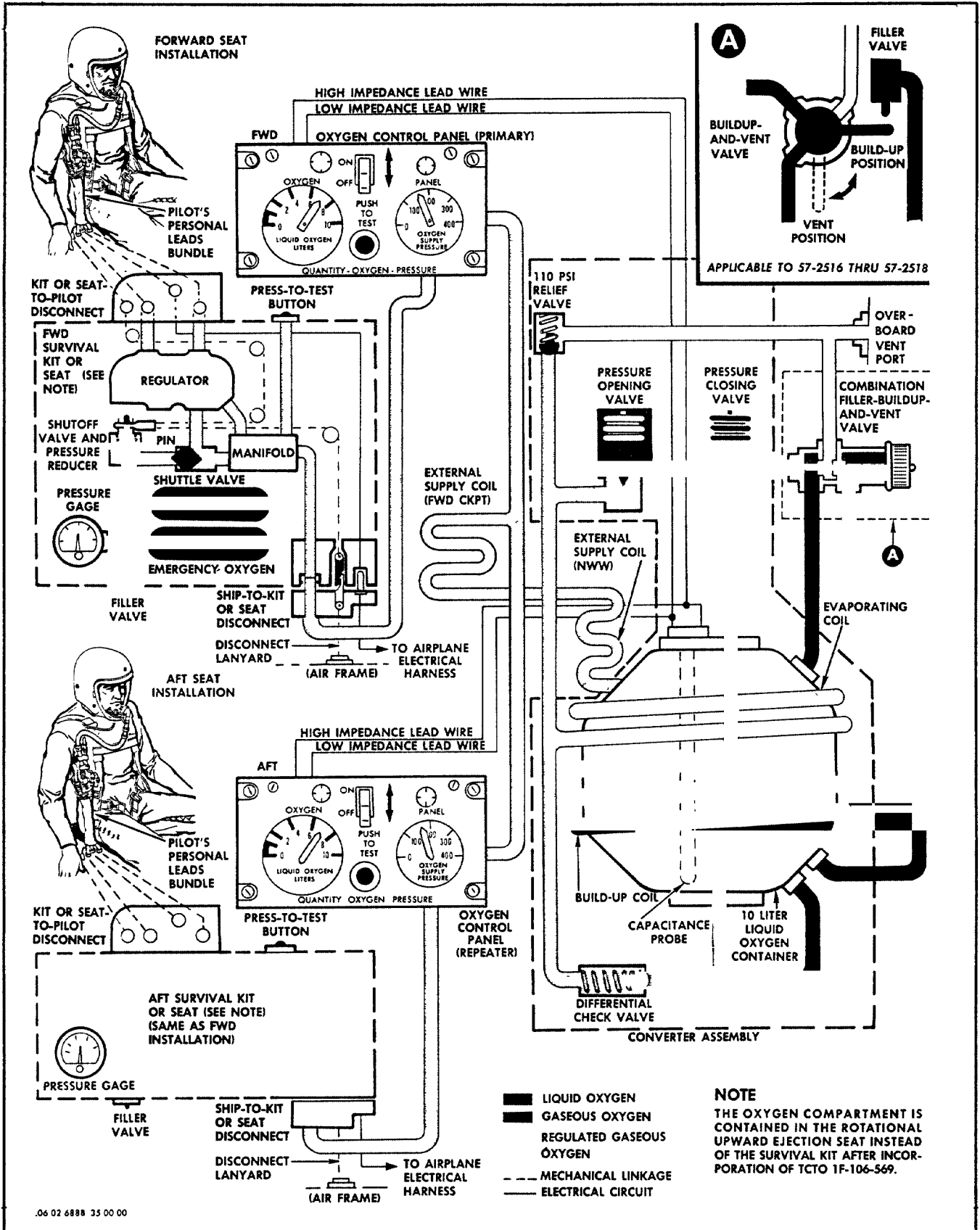

Figure 7-7. Liquid Oxygen Supply System Schematic, F-106B
Applicable to 57-2508 thru 57-2526, 59-149 and subsequent.
Refer to T.O. 1F-106A-2-6 for other versions

Section VIII

FLIGHT CONTROL SYSTEMS

<i>Contents</i>	<i>Page</i>
General	8-1
Mechanical Systems	8-2
Hydraulic System	8-2
Trim Systems	8-5
Artificial Feel System	8-5
Automatic Flight Control System	8-6
Speed Brake System	8-9
Drag Chute System	8-9

GENERAL

8-1. FLIGHT CONTROL SYSTEM DESCRIPTION.

The F-106A and F-106B airplanes are equipped with hydraulically powered flight control surfaces that are manually and/or automatically controlled. The flight control system is made up of the following component sub-systems: mechanical systems, hydraulic systems, trim systems, artificial feel system, automatic flight control system, speed brake system, and drag chute system. See figures 8-1 and 8-2 for a block diagram illustrating the inter-relationship of these sub-systems. Refer to T.O. 1F-106A-2-7 for a complete description of the flight controls system.

8-2. The control surfaces consist of two elevons and a rudder. The elevons combine the function of elevator and aileron surfaces. Each elevon is actuated by two dual-type hydraulic actuators. The rudder is conventional in its control function, and is actuated by one dual-type hydraulic actuator. The flight controls mechanical system transmits control inputs from the control stick(s) and rudder pedals to the control valves of the flight controls hydraulic system. The hydraulic actuators move the control sur-

faces when hydraulic power is applied. The trim system is pilot initiated and electrically actuated. The system is incorporated in the mechanical linkage so that trim is superimposed on the controls. The entire control surface is moved to trim the airplane; trim tabs are not incorporated on the surface. The artificial feel system applies artificial control loads to the elevator function of the control stick(s) and rudder pedals proportional to the aerodynamic forces being encountered by the respective control surfaces. Aileron feel is provided by a centering cam and springs and does not vary with changes of speed or altitude. Artificial feel systems are necessary to offset the complete lack of feel produced by the hydraulic actuation of the control surfaces. The automatic flight control system stabilizes the airplane about its pitch and yaw axes, co-ordinates elevon and rudder movements during turn maneuvers, and controls the airplane in response to command signals from ground control stations or the Aircraft and Weapons Control Interceptor System (AWCIS). The speed brake system is used to slow the airplane. When deployed after touchdown, the drag chute further slows the airplane and shortens its landing roll.

MECHANICAL SYSTEMS

8-3. ELEVON CONTROL SYSTEM.

Elevon control inputs originate at the pilot's control stick(s), and are transmitted aft to the hydraulic control valves through a series of control rods, torque tubes, and bellcranks. Control stick movements are conventional: that is, elevator control is applied by moving the control stick forward or aft, and aileron control is applied by moving the control stick to the left or right. Elevon control inputs are transmitted aft from the control stick(s) to the elevon hydraulic control valves through a series of push-pull control rods, torque tubes, bellcranks and a controls mixer assembly, located at station 476.0. When necessary, the mixer assembly combines the elevator and aileron inputs, and the sum of such inputs is applied to the mechanical linkage aft of station 476.0. Centering springs return the controls to neutral when the control stick loads are removed. A fiberglass cover is installed above the controls mixer assembly to prevent foreign objects from falling into the mechanism.

8-4. RUDDER CONTROL SYSTEM.

Rudder control inputs originate at the rudder pedals in the cockpit. During ground operations, with nose wheel steering engaged, the rudder pedals are used to control the position of the nose wheel. The tops of the rudder pedals actuate the airplane wheel brakes system. Rudder control inputs are transmitted aft through control cables that extend from the pedals to the tension regulator in the base of the vertical stabilizer. The tension regulator maintains a cable tension of from 20 to 40 pounds. Tubular control rods transmit rudder control inputs from the tension regulator to the rudder hydraulic control valve and actuator assembly. A centering spring returns the rudder controls to neutral when the pedal forces are removed. Forward and aft adjustment of the rudder pedals is controlled by a switch in the right armrest of the pilot's seat(s).

HYDRAULIC SYSTEM

8-5. GENERAL

The airplane rudder and elevons are operated by hydraulic actuating cylinders supplied with pressure from the primary and secondary hydraulic power supply systems. Hydraulic flow to the actuating cylinders is controlled by hydraulic control valves. These valves operate in response to manual control inputs from the control stick or rudder pedals and/or in response to electrical signals from the automatic flight control system (AFCS). The primary hydraulic system powers only the flight control system; the secondary system supplies all other hydraulic systems in addition to the flight control system. When one of the supply systems is disabled, the remaining system continues to power the flight controls but with slower response and a possible slight increase in stick operating force. Loss of primary hydraulic system pressure will cause loss of yaw damper operation of the rudder.

8-6. Each elevon is moved by two actuating cylinders; one mounted inboard in the fuselage and the other mounted outboard on the underside of the wing. The

rudder is actuated by a single actuating cylinder. Hydraulic flow to the elevon actuating cylinder is controlled by two hydraulic control valves, one for each elevon. Hydraulic oil to the elevon control valves passing through tubing in the No. 3 fuel tank, lowers the oil temperature to prevent control valve malfunctioning. A control valve, integral with the rudder actuating cylinder, controls hydraulic flow to the rudder cylinder actuating chambers. With the engine running, hydraulic pressure is always present in both of the elevon hydraulic control valves and in the rudder control valve. Manual and/or electrical control inputs align the ports of the control valves causing metered hydraulic flow to the appropriate side of the double-acting piston in each hydraulic actuating cylinder. The actuators then move the control surfaces to the position required to satisfy the control input. As the control surfaces move to the desired position, mechanical feedback from the control surface causes the control valve to close; hydraulic flow is then shut off from the actuators.

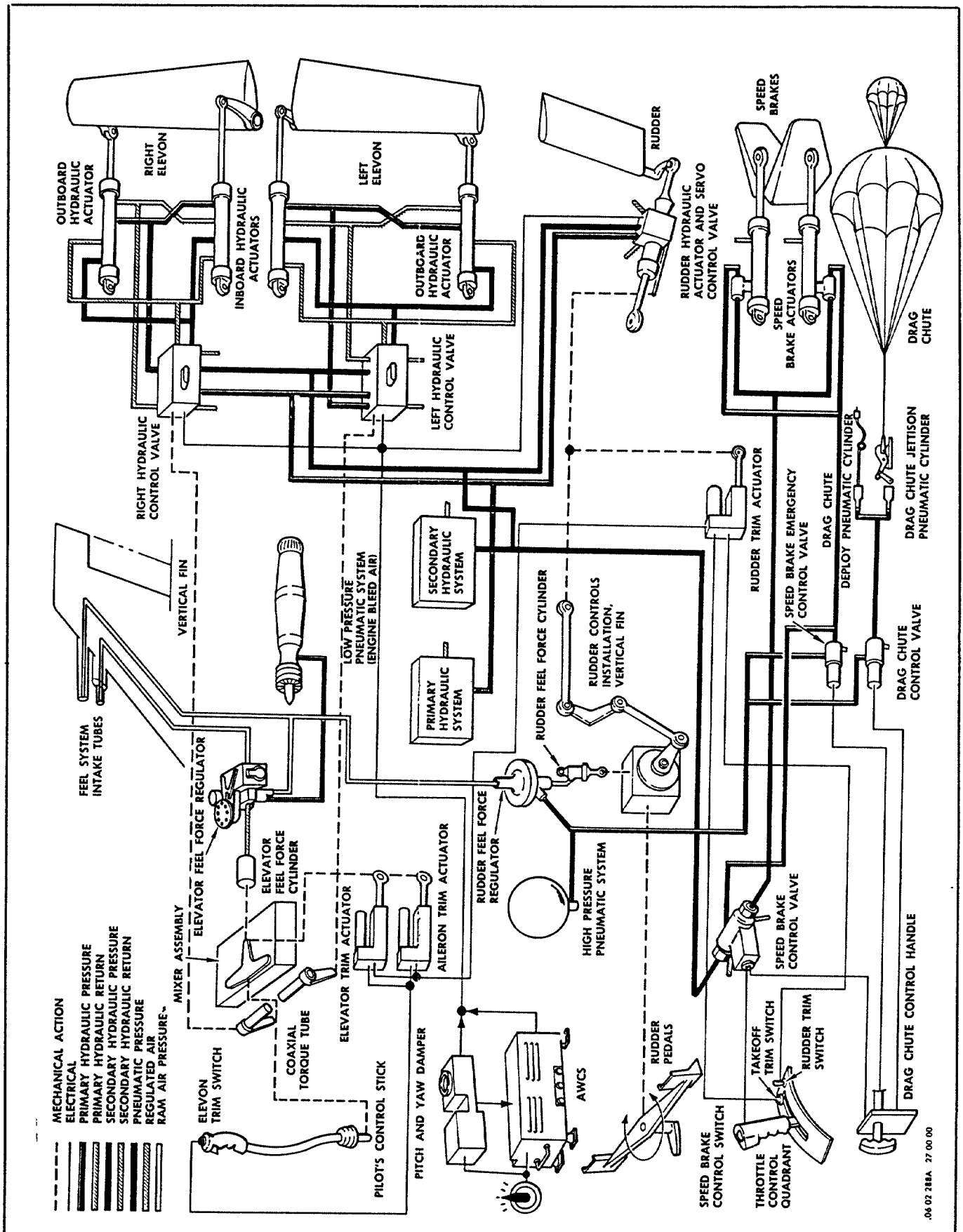
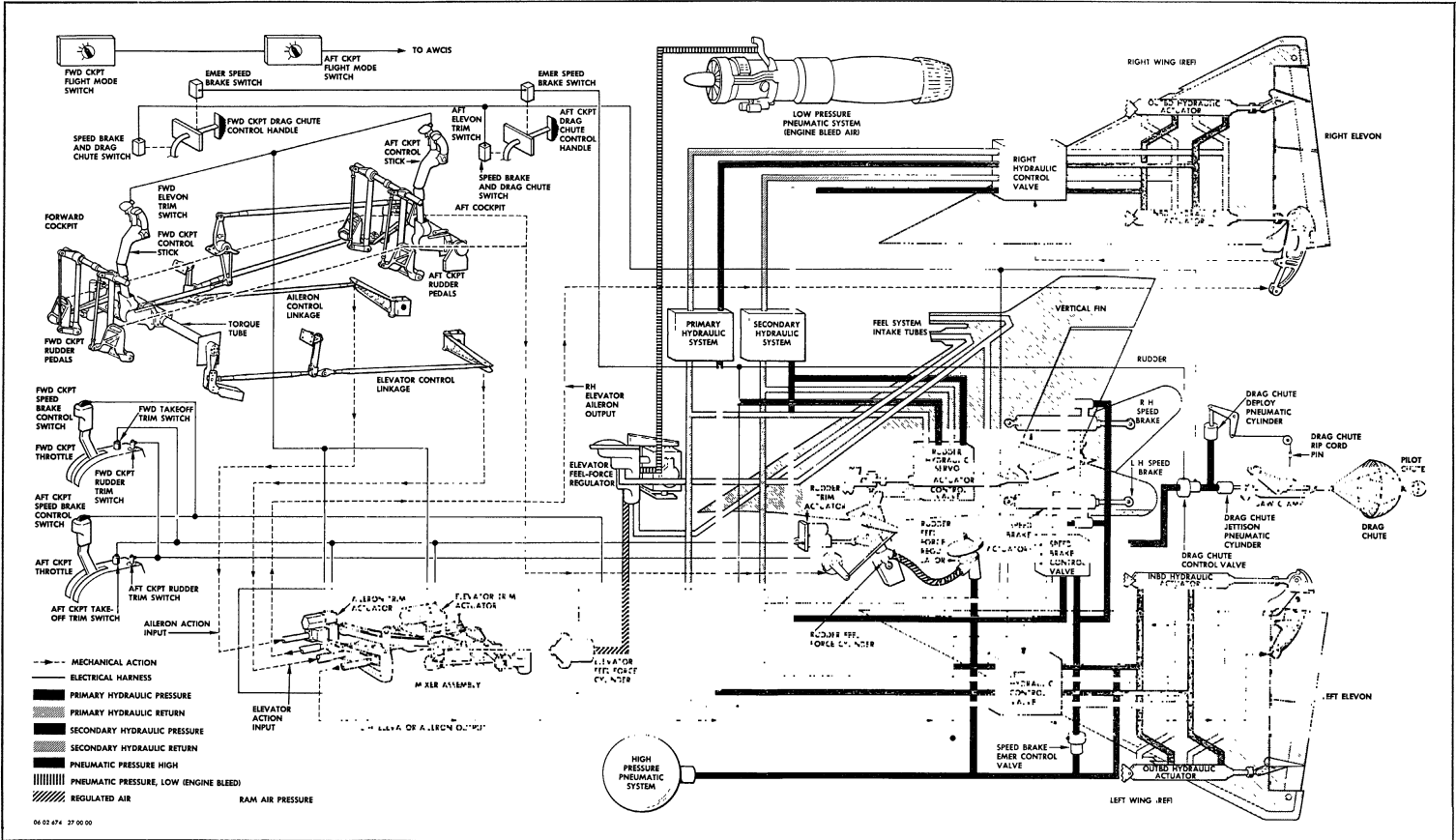

Figure 8-1. Flight Controls System Functional Diagram, F-106A



06 02 874 27 00 00

Figure 8-2. Flight Controls System Functional Diagram, F-106B

TRIM SYSTEMS

8-7. GENERAL.

The trim systems are used to vary the position of the rudder and the elevons. The takeoff trim, rudder trim, and elevon trim systems operate in response to electrical trimming inputs applied at the various trim system controls in the cockpit. The takeoff trim system is used to automatically position all control surfaces for takeoff. The manually operated, electrically controlled rudder and elevon trim systems are conventional in function, and allow the pilot to neutralize control stick and pedal forces when the airplane is in the desired flight attitude. During trim inputs, the elevons are displaced through the interaction of the elevator and aileron trim

actuators upon the T-bellcrank of the controls mixer assembly. Mechanical loads are transferred from the controls mixer assembly, by mechanical linkage, to the elevon hydraulic control valves. During periods of rudder trim, electrical inputs from the cockpit trimming controls are received at the rudder trim actuator in the base of the vertical stabilizer. The rudder trim actuator transfers control forces directly to the rudder hydraulic control valve and actuator.

8-8. In all cases, the control surfaces are displaced by hydraulic power acting through the flight controls hydraulic system.

ARTIFICIAL FEEL SYSTEM

8-9. GENERAL.

The artificial feel system applies artificial control loads to the pilot's control stick and rudder pedals. The artificial loads are required to offset the complete lack of feel produced by the hydraulic actuation of the control surfaces. Loads imposed by the elevator and rudder feel system vary with the airspeed and altitude, to prevent over-control. Two feel system ram air intake tubes are mounted on the leading edge of the vertical stabilizer. Ram air from the upper intake tube is used in both the rudder feel system and the elevator feel system. Ram air from the lower intake tube is used only in the elevator feel system. In addition, the rudder feel system requires pressure from the airplane high pressure pneumatic system. The elevator feel system requires additional pressure from the airplane low pressure pneumatic system. Aileron feel is provided by a spring-loaded centering cam and roller, which are part of the elevon controls mixer assembly. The centering unit positions the mixed T-bellcrank in aileron neutral and provides an aileron "feel" force to the pilot by resisting aileron movement. Resistance of the centering cam increases with increasing control stick movement but does not vary with changes in speed or altitude.

8-10. RUDDER FEEL SYSTEM.

Ram air from the upper intake tube is applied to one side of the diaphragm-controlled variable air pressure regulator in the base of the vertical stabilizer. The ram air serves as a control force that regulates the application of high pressure pneumatic power to the rudder feel-force cylinder. As the airspeed varies, the application of pressure to the cylinder becomes greater or smaller, and a

varying force is imposed upon the rudder feel-force cylinder piston. The cylinder piston is linked mechanically to the rudder control rods. The forces acting upon the piston are felt by the pilot as resistance to pedal movement whenever the rudder is displaced from neutral.

8-11. ELEVATOR FEEL SYSTEM.

Elevator feel is provided by a centering cam and a feel-force cylinder. The centering cam is located in the elevon controls mixer assembly in the forward engine compartment. With the hydraulic system pressurized, the centering mechanism acts to return the elevon control mechanism and the elevons to the neutral position. Ram air from both of the artificial feel system intake tubes is applied through separate lines to the elevator feel-force regulator installed in the engine accessories compartment. Pressure applied to the regulator from the upper ram air intake regulates the flow of engine N_2 bleed air. The regulated N_2 air is applied to a pneumatic actuator to actuate valves and linkage within the regulator. These valves regulate the flow of ram air from the lower ram air intake to the elevator feel-force cylinder. One end of this cylinder, and the static ports of the regulator are vented to the main wheel well area. The other end of the cylinder receives the regulated ram air from the feel-force regulator. The resulting pressure differential causes movement of a piston inside the cylinder which varies the tension loads on the cylinder output cable. The cable is attached to a quadrant which in turn is connected to the elevon mixer assembly. As the control stick and mixer are actuated, the pilot feels the tension loads of the feel-force cylinder output cable. Refer to T. O. 1F-106A-2-7 for complete coverage of this system.

AUTOMATIC FLIGHT CONTROL SYSTEM

8-12. GENERAL.

The automatic flight control system provides the pilot with the following modes of flight operations:

a. **DIRECT MANUAL MODE.** In direct manual mode, the pilot controls the airplane by conventional movement of the control stick and rudder pedals.

b. **YAW DAMPER.** The yaw damper mode stabilizes the airplane about its yaw axis and coordinates rudder movement during turn maneuvers.

c. **PITCH DAMPER.** The pitch damper mode stabilizes the airplane about its pitch axis and coordinates rudder and elevon movement during turn maneuvers. Yaw damper mode remains activated when pitch damper mode is selected.

d. **PILOT ASSIST and AUTOMATIC MODES.** *Applicable to F-106A airplanes 56-453, -454, 56-456 thru 57-245, 57-2465, 58-759 and subsequent, and F-106B airplanes 57-2508 thru 57-2515, 57-2523, 57-2542 and subsequent.*

1. The pilot assist mode maintains the airplane on a preselected heading, attitude and altitude.
2. The automatic mode has three phases of operation as follows: automatic attack, automatic navigation and automatic instrument landing approach.
3. The pilot assist and automatic modes are part of, and receive command signals from, the Flight Control and Measurement subsystem of the Aircraft and Weapon Control Interceptor System (AWCIS). When pilot assist or automatic modes are selected, the yaw damper mode remains engaged, the pitch damper mode is deactivated; pitch damping is included as part of the pilot assist or automatic mode command signals. Maintenance, operation, and servicing instructions for this system and its operating modes are contained in T.O. 1F-106A-2-15 and T.O. 1F-106A-2-27.

8-13. OPERATIONS, DIRECT MANUAL MODE.

Direct manual mode is selected by placing the flight modes switch to direct manual position. When in direct manual mode, the pilot controls the airplane by conventional movement of the control stick and rudder pedals. Mechanical linkage transmits this movement to the elevon and rudder hydraulic control valves. These units meter hydraulic fluid to respective actuators which in turn deflect the control surfaces. Operation in direct manual mode does not require electrical power. Normally the flight control system uses both the primary and secondary hydraulic systems but will operate on either

hydraulic system alone. In event only the primary hydraulic system is available, the flight control system must operate in direct manual mode. In event of an emergency when the AFCS is engaged, the pilot can disengage the AFCS by momentarily depressing an "EMER DIR MAN" switch on the control stick and manually control the airplane. The system reverts to direct manual mode and remains there until another flight mode is selected. When the system is in assist or automatic modes, the pilot can temporarily return the system to pitch damper mode and manually control the airplane by depressing and holding a "MAN MODE TRIGGER" switch on the control stick. When the switch is released, the AFCS will return to the previously selected mode.

8-14. YAW DAMPER MODE.

When yaw damper mode is selected, the AFCS automatically stabilizes the airplane about its yaw axis and coordinates rudder movements to elevon movements during turn maneuvers. The AFCS components used for yaw damper operation are as follows: turn rate transmitter, pitch and yaw damper amplifier, aileron position potentiometer, rudder hydraulic control valve and actuator, and the air data converter. In operation, the rudder is moved by hydraulic pressure metered by the rudder hydraulic control valve to the actuator.

8-15. OPERATION, YAW DAMPER MODE.

When yaw damper mode is in operation, a yaw rate gyro in the turn rate transmitter senses the rate of airplane deviation about the yaw axis. The output signal of the transmitter is applied to the pitch and yaw amplifier. An amplified signal is then supplied to a torque motor in the rudder hydraulic control valve. The torque motor then positions a valve spool to port hydraulic pressure to the rudder hydraulic actuator. Mechanical feedback from the rudder re-positions the valve spool to limit rudder movement, due to yaw damping signal, to six degrees left or right from rudder neutral point. Yaw damping is provided in all operating modes of the AFCS, except during direct manual operation. Yaw damper mode is selected by positioning a flight modes switch to yaw damper position. The flight modes switch is located on the main instrument panel (forward and aft cockpit main instrument panel on F-106B airplanes). See figure 8-3 for a block diagram of damper modes.

8-16. TURN COORDINATION.

The yaw induced when the airplane rolls in response to pure aileron input is minimized by electrical signals supplied to the rudder hydraulic control valve. The electrical signals are proportional to aileron deflection and airplane

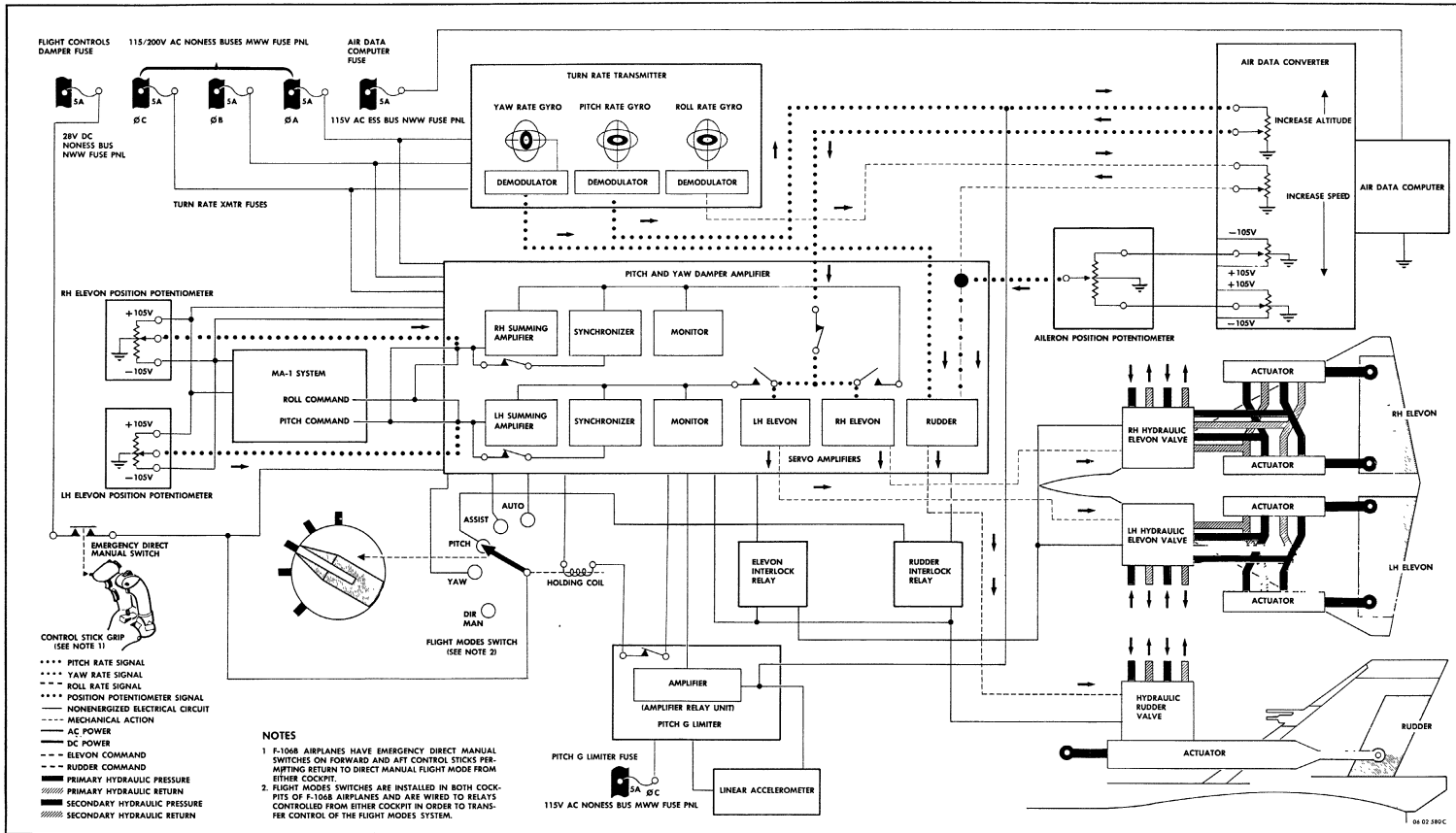

Figure 8-3. Damper Mode Diagram, F-106A

roll rate. A roll rate gyro in the turn rate transmitter senses airplane roll rate. The output signal of the transmitter is modified by the air data converter. The modified signal is added to a signal from the aileron position potentiometer and supplied to the pitch and yaw damper amplifier. An amplified signal is then supplied to a torque motor in the rudder hydraulic control valve. Operation of the torque motor and valve spool, and limited rudder movement is identical to that described in paragraph 8-15. Turn coordination is provided in all operating modes of the AFCS and is absent only during direct manual operation. Refer to T.O. 1F-106A-2-7 for complete description and operation of the yaw damper mode.

8-17. PITCH DAMPER MODE.

When pitch damper mode is selected, the AFCS automatically stabilizes the airplane about its pitch and yaw axes and coordinates rudder movement to elevon movement during turn maneuvers. Yaw damper and turn coordination are briefly described in paragraphs 8-15 and 8-16. The AFCS components used for pitch damper operation are as follows: Turn rate transmitter, pitch and yaw damper amplifier, aileron position potentiometer, right and left elevon hydraulic control valves, left and right elevon hydraulic actuators, rudder hydraulic control valve and actuator, and the air data computer system. In operation, the elevons are moved by hydraulic pressure metered by the elevon hydraulic control valves to respective elevon hydraulic actuators. Electrical power supply for Pitch Damper operation is identical to the supply for Yaw Damper operation, listed in paragraph 8-14.

8-18. OPERATION, PITCH MODE.

When the AFCS is operating in pitch damper mode, yaw damping and turn coordination are provided as described in paragraphs 8-15 and 8-16. In addition, a pitch rate gyro in the turn transmitter senses the rate of airplane deviation about the pitch axis. The output signal is supplied to the air data converter where altitude scheduling of gain and time constant provides the desired system response. The modified signal is supplied to the pitch and yaw amplifier and then to a torque motor in each elevon hydraulic control valve. Each torque motor positions a valve spool to port hydraulic pressure to the respective elevon hydraulic actuator. Mechanical feedback from the elevon position positions the respective valve spool to limit elevon movement, due to pitch damping signals, to one degree up or down from elevon trim position. Pitch damping as described in this paragraph is provided only when the pitch damper mode is selected. Pitch damper mode is selected by positioning a flight modes switch to pitch damper position. The flight modes switch is located on the main instrument panel (forward and aft cockpit main instrument panel on F-106B airplanes). See figure 8-3 for a block diagram of damper modes for specified F-106A airplanes. Refer to T.O. 1F-106A-2-7 for complete description and operation of the pitch damper mode.

8-19. OPERATION, PILOT ASSIST MODE.

The Pilot Assist mode, operating in conjunction with the Damper mode and the AWCIS system, maintains the airplane on a pilot selected heading and attitude. To operate the airplane in the pilot assist mode, the pilot first selects a course heading and attitude. With the airplane stabilized, the "FLT MODE" selector switch on the pilot's instrument panel is rotated to the "ASSIST" position. In order to move the switch from "DIR MAN" to "ASSIST," it is necessary to go through the yaw damper and pitch damper positions. This guarantees that the damper modes are engaged before the assist mode is engaged. The airplane will then continue to fly in the attitude selected until the system is disengaged. Failure of assist mode to remain engaged will cause the flight modes selector switch to return to the next lower mode that will engage. The pilot can override the AFCS by applying higher than normal force to the control stick. Refer to T.O. 1F-106A-2-15 and T.O. 1F-106A-2-27 for complete description and operation of the assist mode.

8-20. OPERATION, AUTOMATIC MODE.

Applicable to F-106A airplanes 56-453, -454, 56-456 thru 57-245, 57-2465, 58-759 and subsequent, and F-106B airplanes 57-2508 thru 57-2515, 57-2523, 57-2542 and subsequent. The Automatic mode, in conjunction with the Damper mode and the AWCIS system, will control the airplane through three phases of operation. These operating phases are as follows:

- a. The Automatic Navigation phase which controls the airplane to and from an attack area.
- b. The Automatic Attack phase which controls the airplane during an attack.
- c. The Automatic Instrument Landing Approach phase which will guide the airplane to within 200 feet of the runway.

Refer to T.O. 1F-106A-2-15 and T.O. 1F-106A-2-27 for complete description and operation of the Automatic Mode.

8-21. PITCH "G" LIMITER SYSTEM.

The pitch "G" limiter system prevents excessive structural loads that might result from electrical command signals when the AFCS is operating in the Assist or Automatic Modes. The pitch "G" limiter unit senses linear acceleration (in the airplane vertical axis) and pitch angular acceleration, and returns the AFCS to the Yaw Damper mode if the continued acceleration would result in excessive loads. The unit consists of a linear accelerometer, the pitch rate gyro in the turn rate transmitter and an amplifier-relay unit. Electrical power is supplied from the 115-volt, 400 cycle, phase "C" nonessential bus, through the "PITCH 'G' LIMITER" fuse on the main wheel well fuse panel. A pitch "G" limiter test circuit receives 28-volt dc power through the "PITCH (G) LIMITER TEST" fuse on the nose wheel well fuse panel. Refer to T.O. 1F-106A-2-7 for information regarding this system.

SPEED BRAKE SYSTEM

8-22. GENERAL.

Two speed brake doors, each hinged to the fuselage structure directly below the vertical stabilizer, can be extended a maximum of 60 degrees to slow the airplane. The speed brakes also fair in the housing for the drag chute. The speed brakes are normally extended and retracted hydraulically by power connected from the secondary hydraulic system. In an emergency in which hydraulic power is lost, the speed brakes can be extended pneumatically by power applied from the high pressure pneumatic system. However, the speed brakes cannot be retracted pneumatically. Both the hydraulic and pneumatic phases of speed brake operation require dc control power. Dc power is connected through a "SPEED BRAKES" fuse, and through an "EMER CHUTE DEPLOY" fuse. The speed brakes are normally (hydraulically) controlled from the speed brake switch on the pilot's throttle control lever. *Applicable to F-106B airplanes*, the speed brakes are normally controlled as follows:

- a. In the forward cockpit: by a holding speed brake three-position switch on the throttle lever.
- b. In the aft cockpit: by a three-position momentary speed brake switch on the throttle lever.

Actuation of forward and aft cockpit speed brake switches to opposite positions will result in no speed brake movement. One switch must be at "OFF" position before the other switch can operate the speed brakes. *Applicable to all airplanes*, during an emergency in which secondary hydraulic system power is lost, the speed brakes can be extended pneumatically and the drag chute automatically deployed. To accomplish this, the drag chute "T" handle is pulled straight out, rotated clockwise 90 degrees and then pulled again. Since the speed brakes fair in the drag chute canister housing, the speed brakes must be opened at least 30 degrees before the drag chute can be deployed. Refer to T.O. 1F-106A-2-7 for detailed information regarding the speed brake system.

DRAG CHUTE SYSTEM

8-23. GENERAL.

After landing, the drag chute can be deployed to slow the airplane, and shorten the landing roll. The drag chute is packed in a deployment bag, and stowed in the drag chute canister in the fuselage structure at the base of the vertical stabilizer. The speed brakes fair in the aft side of the drag chute canister, and must be extended at least 30 degrees before the drag chute can be deployed. When the airplane has been slowed, the drag chute can be jettisoned, and the speed brakes retracted. The drag chute mechanism is electrically-controlled, and pneumatically actuated. DC power is supplied from pin "M" on the battery, through the "EMER CHUTE DEPLOY"

fuse. The drag chute can be deployed by operating the T-shaped drag chute control handle on the pilot's instrument panel. The drag chute is normally jettisoned from the airplane by returning the drag chute control handle to the "in" position. Refer to paragraph 8-22 for a description of the emergency operation when the speed brake and drag chute systems fail to operate normally. *Applicable to F-106B airplanes*, the drag chute system is essentially the same as *on F-106A airplanes*, difference being that both the forward and aft cockpits are furnished with a T-shaped drag chute control handle. Refer to T.O. 1F-106A-2-7 for detailed information regarding the drag chute system.

Section IX

LANDING GEAR SYSTEM

<i>Contents</i>	<i>Page</i>
General	9-1
Landing Gear Hydraulic System	9-1
Landing Gear Pneumatic System	9-2
Landing Gear Normal Control Circuit	9-2
Landing Gear Emergency Control Circuit	9-5
Landing Gear Position Indicating and Warning Systems	9-6
Nose Wheel Steering System	9-6
Wheel Brake System	9-8

GENERAL

9-1. DESCRIPTION.

The F-106A and F-106B airplanes are equipped with a retractable tricycle landing gear consisting of two main landing gear assemblies, and one steerable nose landing gear assembly. The main landing gear assemblies retract inboard and up into the wheel wells in the wing-fuselage area. The nose landing gear retracts forward and up into the nose landing gear wheel well in the fuselage. The landing gear system is discussed in detail in T.O. 1F-106A-2-8.

9-2. Operating controls for the landing gear system consist of a landing gear control handle, an emergency gear-up button, and an emergency gear-down handle. All of these controls are located in the cockpit. The landing gear control handle is used for normal hydraulic exten-

sion or retraction of the landing gear. When hydraulic pressure is not available for landing gear extension, the emergency gear down handle is used to extend the landing gear pneumatically. The emergency landing gear control handle is located above the forward end of the left console, just inboard of the normal landing gear control handle. Ground safety switches (one on each main gear) are incorporated in the landing gear control circuit to prevent accidental retraction of the landing gear when the weight of the airplane is on the shock struts. In event of an emergency condition, the ground safety switches may be overridden by placing the landing gear control handle in the up position and depressing the emergency gear-up button. The gear will then retract hydraulically regardless of whether the airplane is airborne or groundborne.

LANDING GEAR HYDRAULIC SYSTEM

9-3. GENERAL.

The landing gear is hydraulically operated by the secondary hydraulic system. Control of the landing gear

hydraulic system is electrical, through connection of 28-volt dc power from the essential bus. Two electrically-controlled and sequenced selector valves direct the flow

of hydraulic fluid to the nose and main landing gear door actuating cylinders. Restrictors installed in the landing gear hydraulic lines control the speed of the gear extension and retraction. A priority valve in the nose landing gear door "open" line prevents surge pressures from opening the door. The landing gear hydraulic system is shown schematically on figure 9-1.

9-4. The nose landing gear actuating cylinder shaft retracts to extend the nose landing gear; the main landing gear actuating cylinder shafts actuate to extend the main landing gear. The nose landing gear door actuating shaft extends to open the nose landing gear door, and the main landing gear door actuating cylinder shafts retract to open the main landing gear doors. Overtravel is adjusted into each actuating cylinder to provide for airframe deflection and gear locking action.

LANDING GEAR PNEUMATIC SYSTEM

9-5. GENERAL.

The landing gear pneumatic system provides an emergency method of extending the landing gear when hydraulic power is not available. No provisions are made for retracting the landing gear pneumatically. Pressure for emergency operation of the landing gear is obtained from the high pressure pneumatic system. Pneumatic (emergency) landing gear extension is initiated by pushing down and then pulling aft on the emergency gear-down handle. *Applicable to F-106A airplanes 59-031 and subsequent, and F-106B airplanes 59-149 and subsequent,* the emergency landing gear control handle is moved inboard prior to pulling aft to prevent accidental change

in throttle setting. Pulling the handle operates the lever of the landing gear emergency control valve located forward of the instrument panel. The lever of the valve simultaneously actuates a switch mounted on the valve; this action electrically prevents hydraulic actuation of the landing gear as long as the emergency control valve is in the emergency position. When the emergency control valve is actuated, high pressure air is directed to the nose and main landing gear hydraulic systems through shuttle valves on each of the gear actuating cylinders. Priority valves and a resistor check valve control sequencing of all landing gear and landing gear doors. The landing gear pneumatic system is shown schematically on figure 9-2.

LANDING GEAR NORMAL CONTROL CIRCUIT

9-6. GENERAL.

The landing gear control circuit sequences the operation of the landing gear and the landing gear doors. Landing gear position is selected by a landing gear control handle. Positioning the handle directs electrical power through control relays and limit switches to energize the selector valves for the desired operation. The circuit receives 28-volt dc power from the essential bus through the "LANDING GEAR CONTROL" fuse on the cockpit left fuse panel. The landing gear control handle is located above the forward end of the left console. Three position lights are located on the left side of the instrument panel. The warning light is located under the position lights; refer to paragraph 9-12 for additional information on the landing gear position indicating and warning systems. *Applicable to F-106B airplanes,* a landing gear control handle is installed in each cockpit. Duplicate position and warning lights are also located in each cockpit.

9-7. LANDING GEAR NORMAL RETRACTION CYCLE.

Applicable to F-106A airplanes 59-031 and subsequent; and 57-246 thru 59-030 after incorporation of TCTO 1F-106A-574. Applicable to F-106B airplanes 57-2542 and

subsequent; and 57-2516 thru 57-2541 after incorporation of TCTO 1F-106A-574 (forward cockpit only F-106B), a spring-loaded trigger type uplock is attached to the landing gear normal control handle to prevent accidental gear extension. When the landing gear control handle is moved to the up position, with the ground safety switches actuated and the weight of the airplane is off the gear, the system operates as follows: solenoids No. 1 and No. 2 of the nose and main landing gear selector valves are energized to allow hydraulic "retract" pressure to enter the nose and main landing gear actuating cylinders, and to direct hydraulic pressure to the nose and main landing gear door actuating cylinders to hold the doors open. As the gear reaches its retracted position, the nose and main landing gear up position switches are actuated to remove electrical power from the main and nose landing gear selector valve solenoid No. 2. No. 1 solenoid remains energized to direct "closed" pressure to the door actuating cylinders. When the doors are closed, the door position switches open the circuits and both solenoids are deenergized. The hydraulic selector valves then return to neutral, and the landing gear and doors are held in the retracted position by mechanical locking mechanisms.

(BK 8)
BLACK OF 3 .06.02.156 G.32.01.00

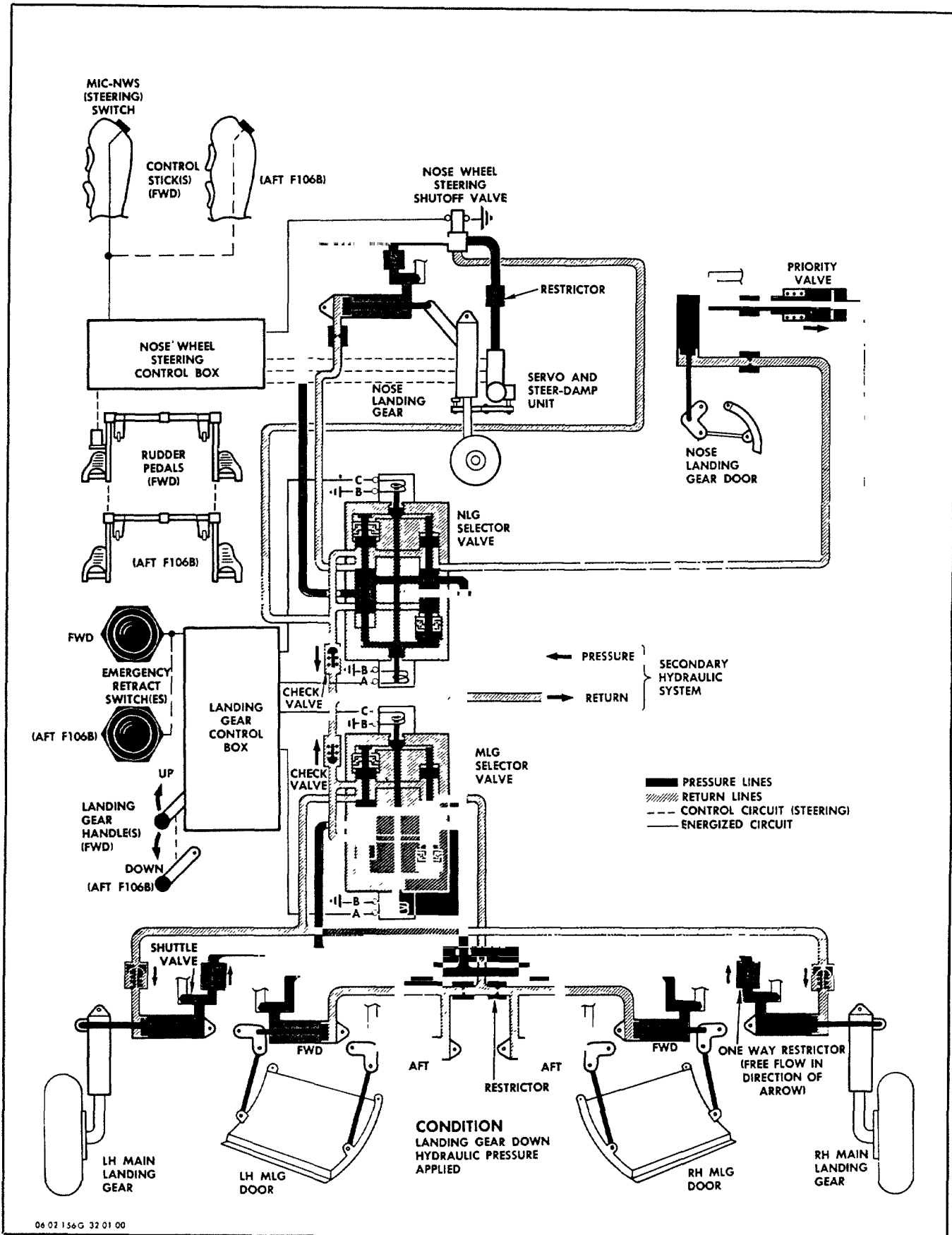

06 02 156 G 32 01 00

Figure 9-1. Landing Gear Hydraulic System

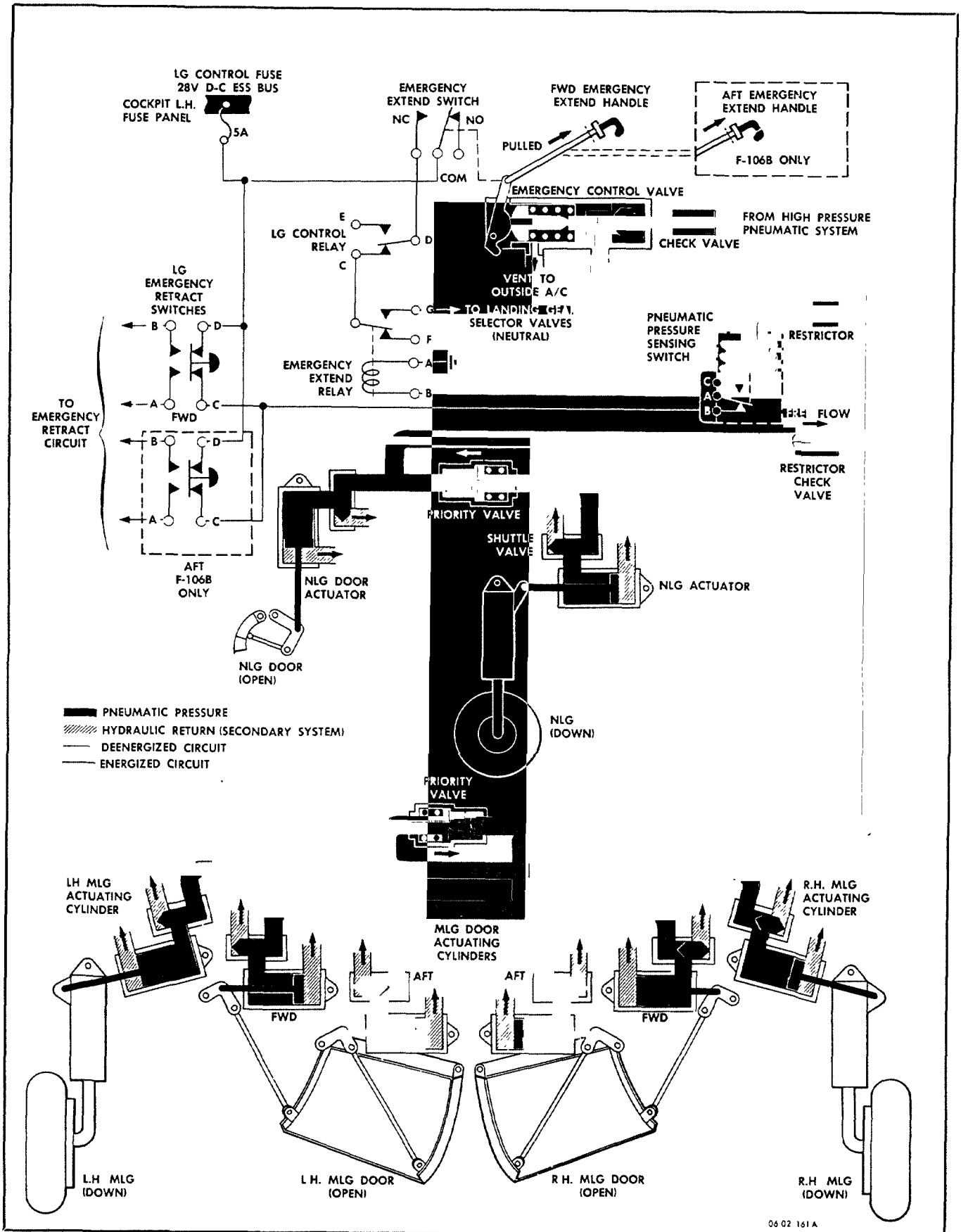

06 02 161 A

Figure 9-2. Landing Gear Emergency Pneumatic System

9-8. LANDING GEAR NORMAL EXTENSION CYCLE.

When the landing gear control handle is moved to the down position, a switch in the landing gear control box is actuated to energize solenoid No. 1 and No. 2 of the main and nose landing gear selector valves. Hydraulic pressure is then directed to the "open" side of the main and nose landing gear door actuating cylinders, and hydraulic "retract" pressure to the main landing gear actuating cylinder. The "retract" pressure removes the weight of the main gear from the main gear doors, and holds the main gear in the retracted position until the main

gear doors are fully open. The nose landing gear is held in the retracted position by a mechanical lock in the drag brace strut. When the doors reach their fully open position, the door open limit switches are actuated, and electrical power is removed from the No. 1 solenoids. No. 2 solenoids remain energized to direct hydraulic pressure to the "extend" side of the main and nose landing gear actuating cylinders while maintaining open pressure on the door cylinders. After the gear is fully extended, hydraulic pressure remains on the door and gear actuating cylinders to maintain the gear in the down and locked position, and to prevent buffeting of the gear doors.

LANDING GEAR EMERGENCY CONTROL CIRCUIT

9-9. GENERAL.

Two emergency systems are provided; one for retracting the gear, and one for extending the gear. The emergency retract provision is essentially an electrical by-pass of the ground safety switches. This system will retract the gear if the safety switches should malfunction, or if retraction is necessary as an emergency measure while the airplane is on the ground. The emergency extend provisions consist of two separate actions; pneumatic actuation of the hydraulic actuators to extend the gear, and electrical disconnection of the normal control system.

9-10. LANDING GEAR EMERGENCY EXTEND CYCLE.

The emergency extend sequence is initiated by pushing down and then pulling the emergency gear extend handle aft until the handle stop is contacted. *Applicable to F-106A airplanes 59-031 and subsequent, and F-106B airplanes 59-149 and subsequent*, the emergency handle is moved inboard prior to pulling aft to prevent accidental change in throttle setting. This operates the gear emergency control valve. The valve ports air from the high pressure pneumatic system through shuttle valves to the extend side of each landing gear hydraulic actuating cylinder. This action also operates a switch that disconnects all power from the electrical control circuits. As an additional precaution, a pressure sensing switch located in the pneumatic line downstream from the selector valve, closes as the supply line fills with air. The sensing switch completes the circuit to the emergency extend relay. When the relay is energized, the normal control circuits are disconnected from the hydraulic selector valves. This action neutralizes the selector valves allowing normal hydraulic return flow during emergency extend cycle. The emergency extend relay will remain energized until air pressure in the line is reduced by venting to 30 to 50 psi. The high pressure air is vented

by returning the emergency control handle to its forward position. At this specified pressure range, the pressure sensing switch opens, and the emergency extend relay is deenergized. The normal control circuit is then restored, and the landing gear can be actuated through the normal landing gear control handle providing hydraulic pressure is available.

CAUTION

Refer to T.O. 1F-106A-2-3 for procedure to bleed the landing gear hydraulic system of air after an emergency extend cycle has been accomplished. Improper bleeding can result in damage to system components.

9-11. LANDING GEAR EMERGENCY RETRACTION CYCLE.

The emergency retraction cycle is started by placing the landing gear control handle in gear up position. Pressing the emergency retract switch energizes and locks the emergency retract relay. Once locked, the relay cannot be de-energized until the landing gear control handle is moved to gear down position. When energized, the emergency retract relay interrupts any existing extend signal and initiates a normal retraction cycle. If emergency gear retraction is necessary after emergency gear extension, normal electrical circuits are restored before high pressure air is completely bled. The emergency retract switch breaks the circuit to the emergency extend relay, permitting the relay to drop out and restore the normal circuits. The operator must first push the emergency landing gear extend handle forward to start the venting action, and then raise the landing gear control handle to the gear up position. Raising the handle connects electrical power required to retract the gear. The emergency retract switch must be held by the operator until the retraction cycle has actually started.

LANDING GEAR POSITION INDICATING AND WARNING SYSTEMS

9-12. GENERAL.

The F-106A and F-106B airplanes are equipped with a position indicating system to indicate landing gear position, and a warning system to indicate malfunction or operational error. Landing gear position is indicated by three green lights, one for each gear. The lights are located on the left side of the instrument panel. The lights illuminate when the gear is fully down and locked. All three position lights must illuminate before it is safe to land. The warning system warns the pilot of a malfunction by a red warning light, and an audible signal in the pilot's headset. A "GEAR UNSAFE" red warning light is located under the three green position lights on the pilot's instrument panel. The light illuminates when the landing gear or gear doors are not in the position selected by the control handle. An audible signal system operates, when the landing gear and doors are not extended and locked during a landing approach. The audible signal can be silenced by means of a push button on the forward end of the left console. Duplicate controls, position lights, and warning system are located in the aft cockpit of the F-106B airplanes.

9-13. LANDING GEAR POSITION LIGHTS.

Three green position lights are installed on the left side of the instrument panel to inform the pilot when the landing gear is down and locked. Each light indicates the position of one of the landing gears. The lights are connected to the 28-volt dc essential bus through the "LDG GEAR POS" fuse on the nose wheel well fuse panel.

9-14. LANDING GEAR WARNING LIGHT.

A "GEAR UNSAFE" red warning light on the pilot's instrument panel illuminates when the landing gear or gear doors are not in the proper position in relation with

the landing gear control handle. The warning lights will also illuminate whenever the audible warning signal is heard. The warning light should never illuminate when the green position lights are illuminated. When the landing gear control handle is moved to the gear up position after the airplane is airborne, the warning light will illuminate, and remain illuminated until the gear is up and the landing gear doors are closed. Illumination of the warning light, when the gears and doors should be full-up or full-down, indicates a malfunction. The warning lights receive power from the 28-volt dc essential bus through the "LDG GEAR POS" fuse.

9-15. LANDING GEAR AUDIBLE WARNING SYSTEM.

An audible warning signal is heard in the pilot's headset whenever one or more of the landing gears are not down and locked during a landing approach. The conditions required to energize this system are as follows:

- a. The airplane's altitude must be less than 10,000 (+350, -0) feet.
- b. The airplane's airspeed must be less than 220 (+10, -10) knots.
- c. The throttle position must be below full military power.
- d. Either of main landing gear down-lock switches not in down-and-locked position or nose landing gear down position switch in up position.

Warning is provided by a landing-gear-warning signal generator, located on the left-hand side of the nose wheel compartment. The airspeed and altitude switches are a portion of the air data computer system. Refer to T.O. 1F-106A-2-8 for complete information regarding this system.

NOSE WHEEL STEERING SYSTEM

9-16. GENERAL.

Nose wheel steering is accomplished by an electro-hydraulic steering system. The system is engaged by depressing a button switch (MIC-NWS) located on the control stick grip. On F-106B airplanes, the system may be engaged by depressing the (MIC-NWS) switch on the control stick grip in either the forward or aft cockpit. When the system is engaged, steering signals are initiated by movement of the rudder pedals. *Applicable to F-106A airplanes 57-246 thru 57-2455 and F-106B airplanes 57-2516 thru 57-2526.* A dc system is employed for electrical control of nose wheel steering. The dc system con-

sists of a command potentiometer, a feedback potentiometer, a signal amplifying control box and related electrical components. *Applicable to F-106A airplanes 56-453, -454, 56-456 thru 57-245, 57-2456 and subsequent, and F-106B airplanes 57-2508 thru 57-2515, 57-2527 and subsequent,* the nose wheel steering system is controlled by 115-volt ac power in addition to 28-volt dc power. The system receives power from the 115-volt ac and 28-volt dc nonessential buses through the "NOSE WHEEL STEER" fuses on the nose wheel well fuse panel. An ac power interlock relay is installed in the nose wheel steering system to disconnect 28-volt dc power when

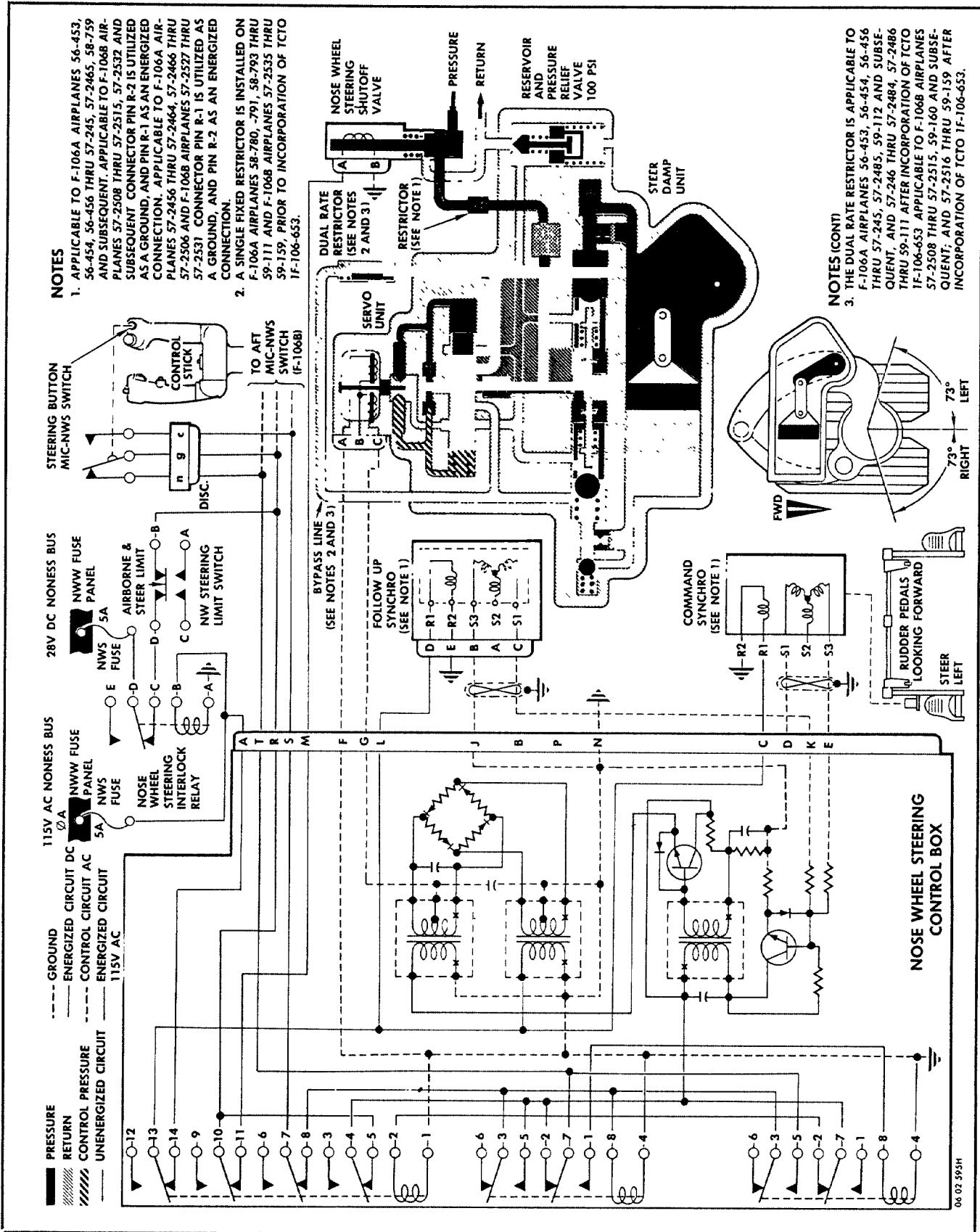

Figure 9-3. Nose Wheel Steering, AC System Schematic
 Applicable to F-106A airplanes 56-453, -454, 56-456 thru 57-245, 57-2456 and subsequent. Applicable to F-106B airplanes 57-2508 thru 57-2515, 57-2527 and subsequent. Refer to T.O. 1F-106A-2-8 for other versions.

115-volt ac power is not available. The electrical system consists of a command synchro transmitter, a follow-up synchro, a signal amplifying control box, and related electrical components. See figure 9-3 for a schematic illustration of this system. Both systems function identically; the difference in the systems being the manner of signal detection and amplification. Refer to T.O. 1F-106A-2-8 for detailed information regarding both nose wheel steering systems. There are three hydraulic components in the system: an electrically actuated, three-way, two-position shutoff valve, a steer-damp unit, and an electro-hydraulic servo valve with an integral control spool. A restrictor is located downstream of the shutoff valve to provide a maximum steering rate of approximately 20 degrees per second. The steer-damp unit is mounted on the aft side of the nose landing gear shock strut. The shutoff valve is located in the hydraulic pressure line to the steer-damp unit, and is also connected into the secondary hydraulic system return line. The servo valve is mounted on the steer damp unit. The steering system receives hydraulic pressure from the nose landing gear actuating cylinder "down" line. This arrangement prevents the operation of the steering system, when the nose landing gear is not extended. When electrically energized, the steer-damp unit functions to provide controlled steering of the nose wheel. When deenergized, the steer-damp unit serves as a shimmy damper.

CAUTION

Do not attempt to operate the nose wheel steering system electrically if the hydraulic system is depressurized as damage to the servo control valve will result.

9-17. STEERING CONTROL.

Applicable to F-106A airplanes 57-246 thru 57-2455, and F-106B airplanes 57-2516 thru 57-2526, the steering system is controlled by electrical power received through the "NOSE WHEEL STEER" fuse from the 28-volt dc nonessential bus of the nose wheel well fuse panel. The steering control system consists of a button-operated (MIC-NWS) switch mounted on the pilot's control stick grip, a command potentiometer linked mechanically to the rudder bellcrank, and a feedback potentiometer mounted on the steer-damp unit. The system also includes an amplifier control box mounted in the nose wheel well,

and an electro-hydraulic servo valve mounted on the steer-damp unit. Magnitude of the valve electrical signal, dependent on potentiometer position, determines direction of movement of the servo valve. The steering system is energized when the MIC-NWS switch is depressed and released; depressing the switch a second time will deenergize the system. When the system is energized, movement of the rudder pedals displaces the wiper of the command potentiometer. This produces an electrical unbalance between the command potentiometer and the feedback potentiometer. The unbalanced signal is amplified in the control box, and causes the servo valve solenoid to move the valve spool. The servo valve then directs hydraulic pressure to the appropriate side of the piston in the steer-damp unit. The piston then moves mechanical linkage to turn the nose wheels in the correct direction. When the wheel is in the turning angle that corresponds to the rudder pedal position, the feedback potentiometer is mechanically moved to the position required to cancel the error signal. The electrical unbalance then becomes zero, the servo valve returns to neutral, and the wheels align in their new position of turn. When the system is first energized, the steering response is immediate as long as the nose wheels are within 73 (± 1) degrees right or left of their neutral position. When the switch on the control stick grip is depressed and released, the nose wheels immediately turn to the angle demanded by the position of the rudder pedals. If the rudder pedals are positioned at full right or left rudder, the wheels turn to their full 73 (± 1) degree position, and a limit switch on the nose landing gear shock strut collar is actuated. Actuation of this limit switch deenergizes the complete nose wheel steering system. The wheels must then be returned to a position within the 73 (± 1) degree limit before the system can be re-energized.

9-18. Applicable to F-106A airplanes 56-453, -454, 56-456 thru 57-245, 57-2456 and subsequent, and F-106B airplanes 57-2508 thru -2515, 57-2527 and subsequent. Steering is controlled by 115-volt ac power through the "NOSE WHEEL STEER" 5 amp fuse on the nose wheel well fuse panel. The system functions the same as the dc controlled system except that synchro transmitters are used instead of potentiometers and a different control box is used to amplify ac signals. In this system, the electro-hydraulic servo valve position is dependent on signal magnitude and direction of current flow as determined by the synchro transmitters.

WHEEL BRAKE SYSTEM

9-19. GENERAL.

The main landing gear wheel brakes are pneumatically-powered and hydraulically-controlled. The wheel brakes

hydraulic system is independent of the other hydraulic systems on the airplane, and each wheel brake is independent of the other. The brakes are the segmented, four-rotor type, and are rigidly attached to the main landing

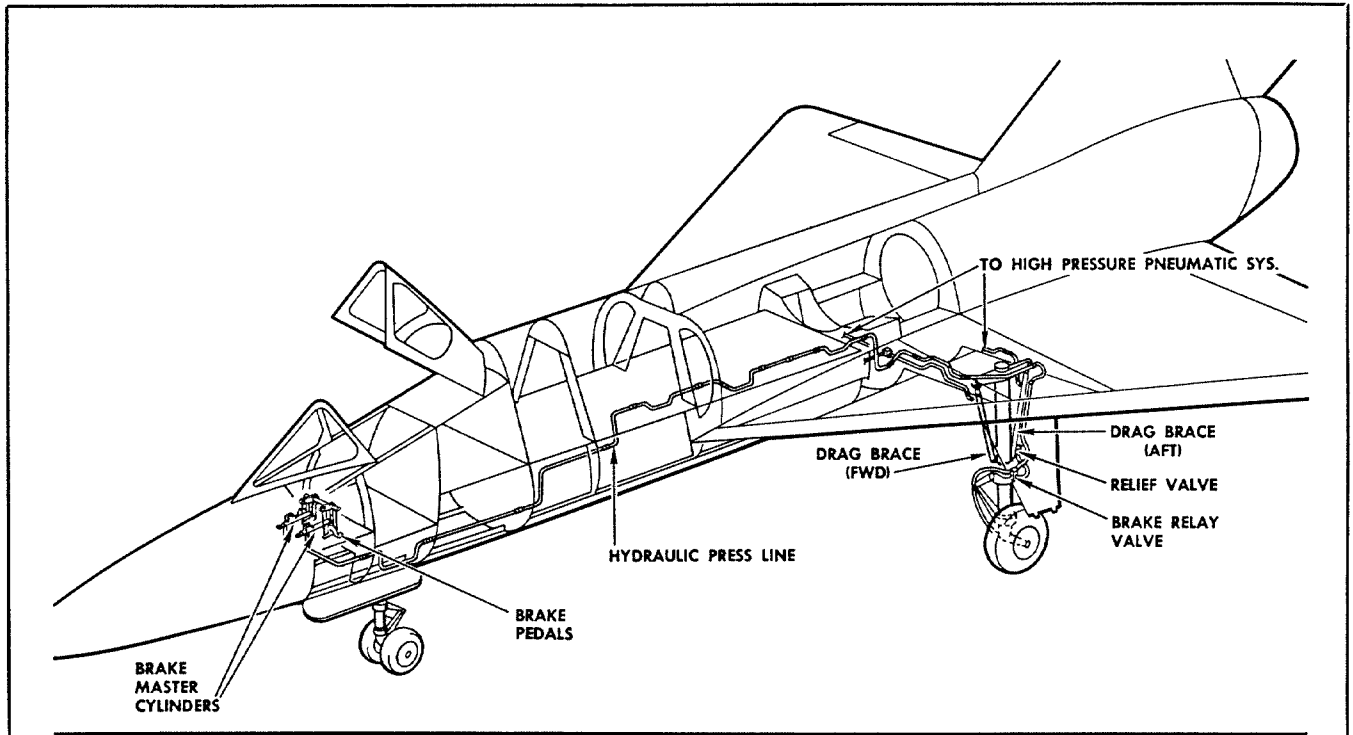

NOTE

AIR BLEED VALVES ARE INSTALLED IN AIRPLANES 57-2478 THRU 57-2506.

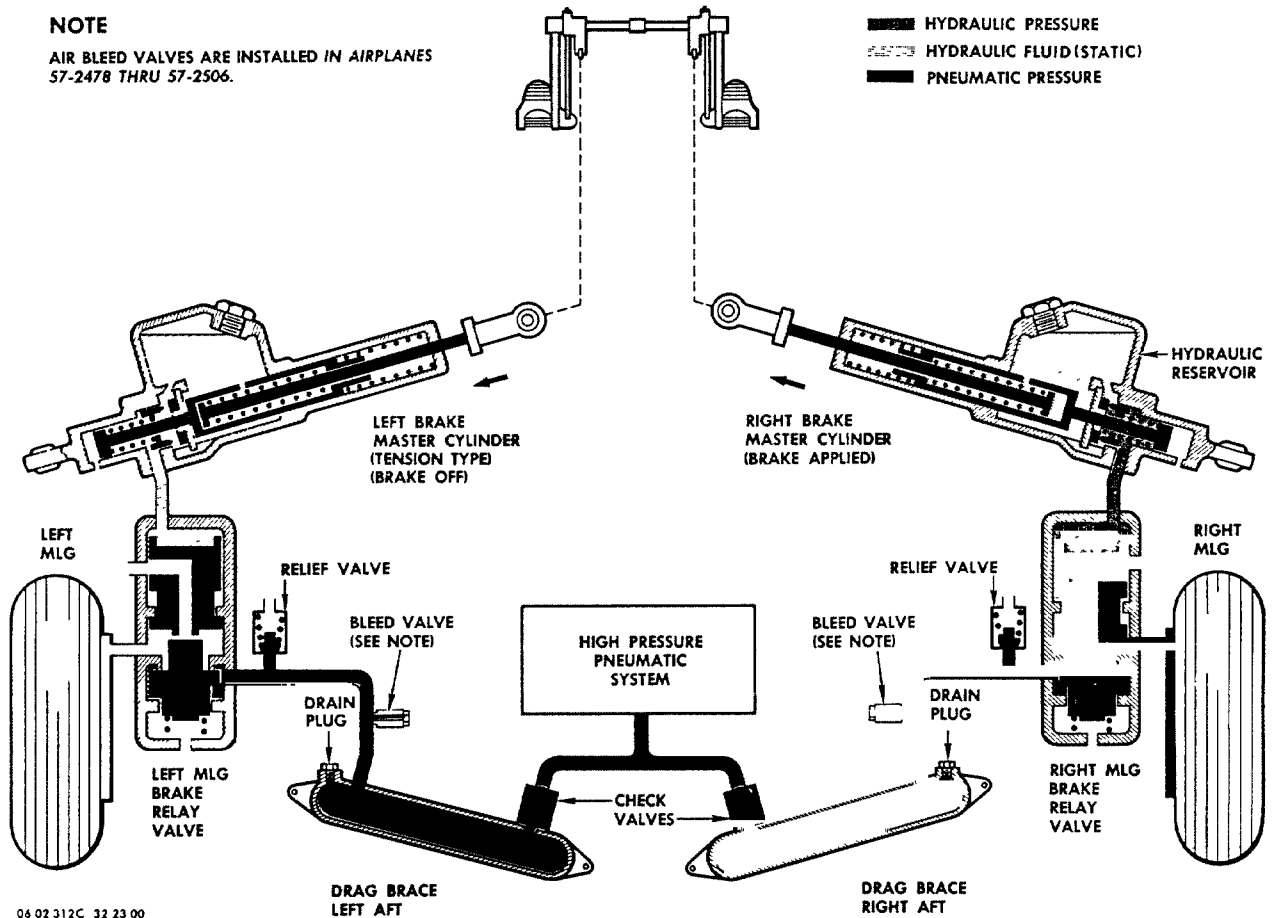

06 02 312C 32 23 00

Figure 9-4. Wheel Brake System, F-106A

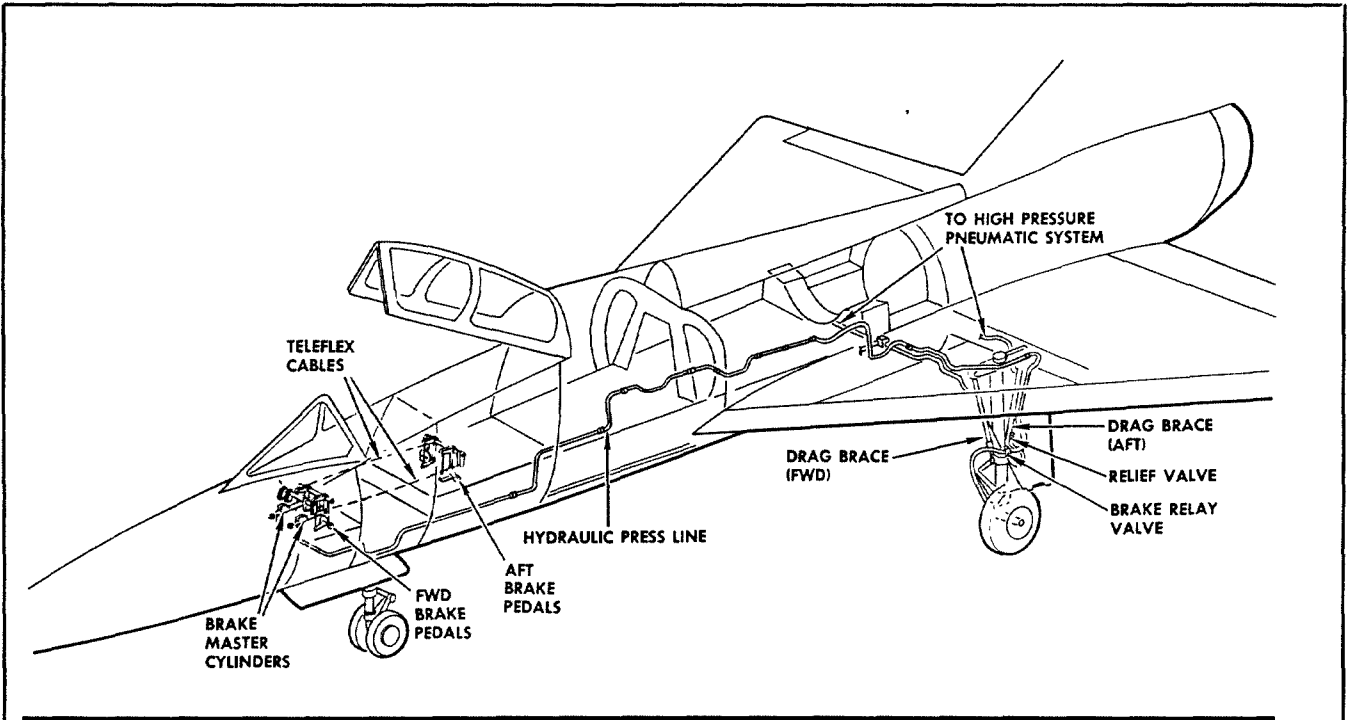

NOTE

AIR BLEED VALVES ARE INSTALLED IN AIRPLANES 57-2527 THRU 57-2531.

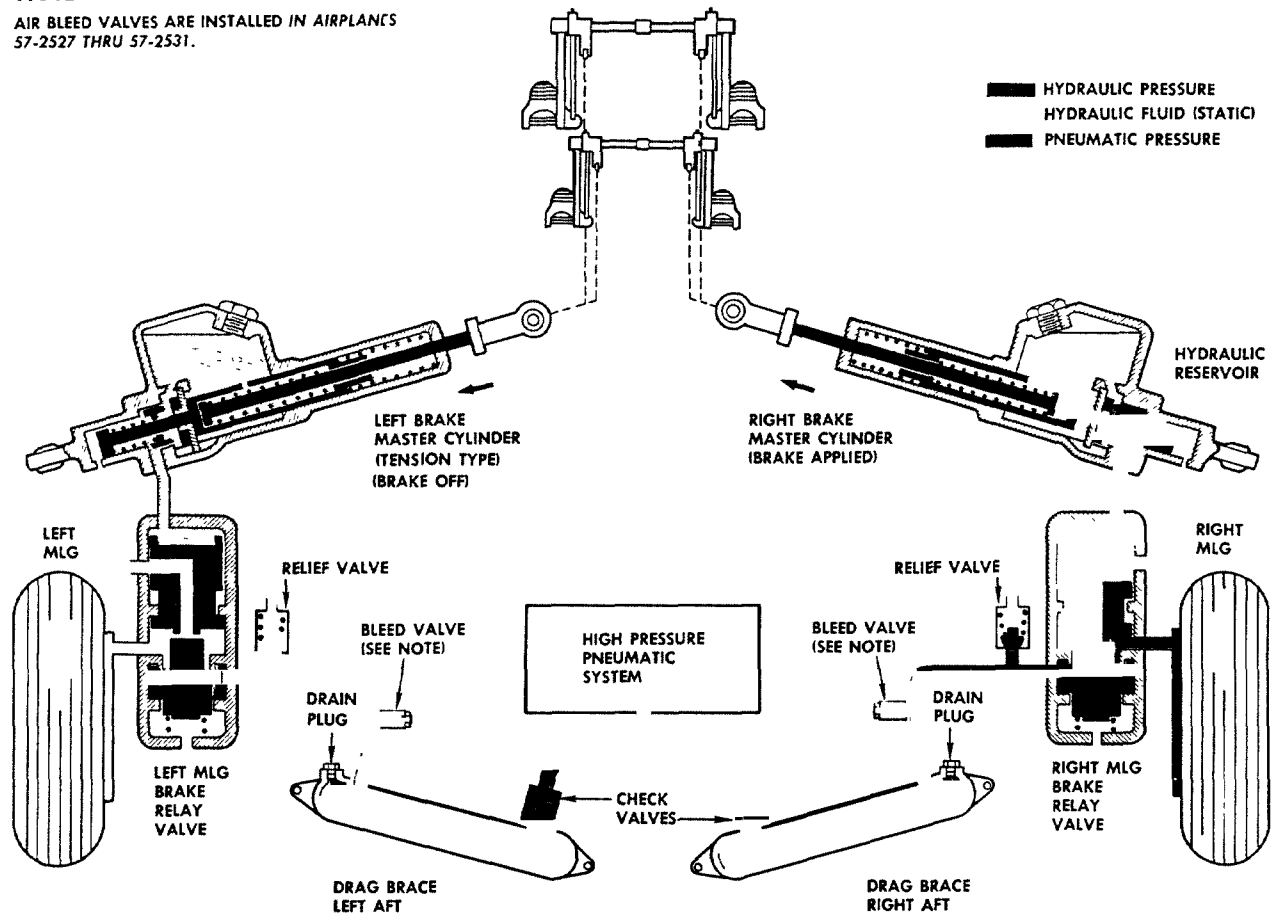

.06 02 303D 32 23 00

Figure 9-5. Wheel Brake System, F-106B

gear axles by ten drive sleeve bolts. Pneumatic pressure for operating the wheel brakes is stored at 3000 (± 100) psi in the hollow main landing gear aft drag brace accumulators. Pneumatic pressure is supplied and maintained in the accumulators by the main system storage flask. If the main system air pressure should become exhausted, a check valve installed in the inlet port of each aft drag brace accumulator, will maintain sufficient pressure in the accumulator for braking the airplane. A relief valve is installed between each aft drag brace accumulator and brake relay valve to prevent over pressurization. *Applicable to F-106A airplanes 56-453, -454, 56-456 thru 57-245, 57-2465, 57-2478 and subsequent, and F-106B airplanes 57-2508 thru -2515, 57-2523, 57-2527 and subsequent*, a bleed valve is installed between each aft drag brace accumulator and brake relay valve to relieve air pressure in the accumulator. *Applicable to F-106A airplanes 57-246, -2464, 57-2466 thru 57-2477,*

and F-106B airplanes 57-2516, -2522, 57-2524 thru 57-2526, air pressure in the aft drag brace accumulators is relieved through a moisture drain plug in the bottom of each accumulator. Hydraulic brake master cylinders, when actuated by each brake pedal, hydraulically actuate a relay valve for the corresponding brake. The relay valve pistons are displaced according to the amount of pressure being applied to the brake pedal. Pneumatic pressure is then emitted from the aft drag brace accumulators to actuate the piston in each brake assembly. The pistons force the stator and rotor plates into contact with each other to provide braking friction. When the brakes are released, the relay valves return to their spring-loaded off positions. Springs in the adjustment assemblies, integral with the brake carriers, return the plates and pistons to their proper brake-off spacing. The wheel brake system is shown schematically in figures 9-4 and 9-5. Refer to T.O. 1F-106A-2-8 for complete coverage of this system.

Section X

INSTRUMENT SYSTEMS

<i>Contents</i>	<i>Page</i>
Instrument Locations	10-1
Flight and Navigation Instruments	10-1
Engine Instruments	10-8
Fuel Quantity Indicating System	10-8
Power Supply System Instruments	10-8

INSTRUMENT LOCATIONS

10-1. GENERAL.

Instruments and warning lights are installed in the cockpit to supply the information necessary for the proper operation and navigation of the airplane. The instruments required to properly service and maintain various systems of the airplane are located in the fuselage. *On F-106A airplanes*, the instruments used during flight are located in the cockpit on the pilot's main instrument panel, the left and right auxiliary instrument panels, and the left and right consoles. The hydraulic system accumulator pressure gages and the pneumatic pressure gage are located in the hydraulic accessories compartment and the

left wheel well respectively. Figures 10-1 and 10-2 illustrate the general arrangement of the cockpit instruments on specified F-106A airplanes. *On F-106B airplanes*, the instruments used during flight are located on the forward and aft instrument panels, the left and right auxiliary instrument panels, and the left and right consoles. The location of the hydraulic system accumulator gages and the pneumatic pressure gage is the same as that on the F-106A airplane. Figures 10-3 and 10-4 illustrate the general arrangement of the cockpit instruments on specified F-106B airplanes. Refer to T.O. 1F-106A-2-9 for complete coverage of the airplane instruments.

FLIGHT AND NAVIGATION INSTRUMENTS

10-2. GENERAL.

The flight and navigation instruments provide the pilot with information showing the flight condition of the airplane, such as airspeed, altitude, and attitude. The pressure sensitive altimeter, airspeed indicator, and vertical velocity indicator are operated by the pitot static system.

The navigation instruments furnish the pilot with the information required to determine and maintain his course, and to make a landing during adverse weather conditions. Refer to T.O. 1F-106A-2-9 for a complete list of flight and navigation instruments and their function.

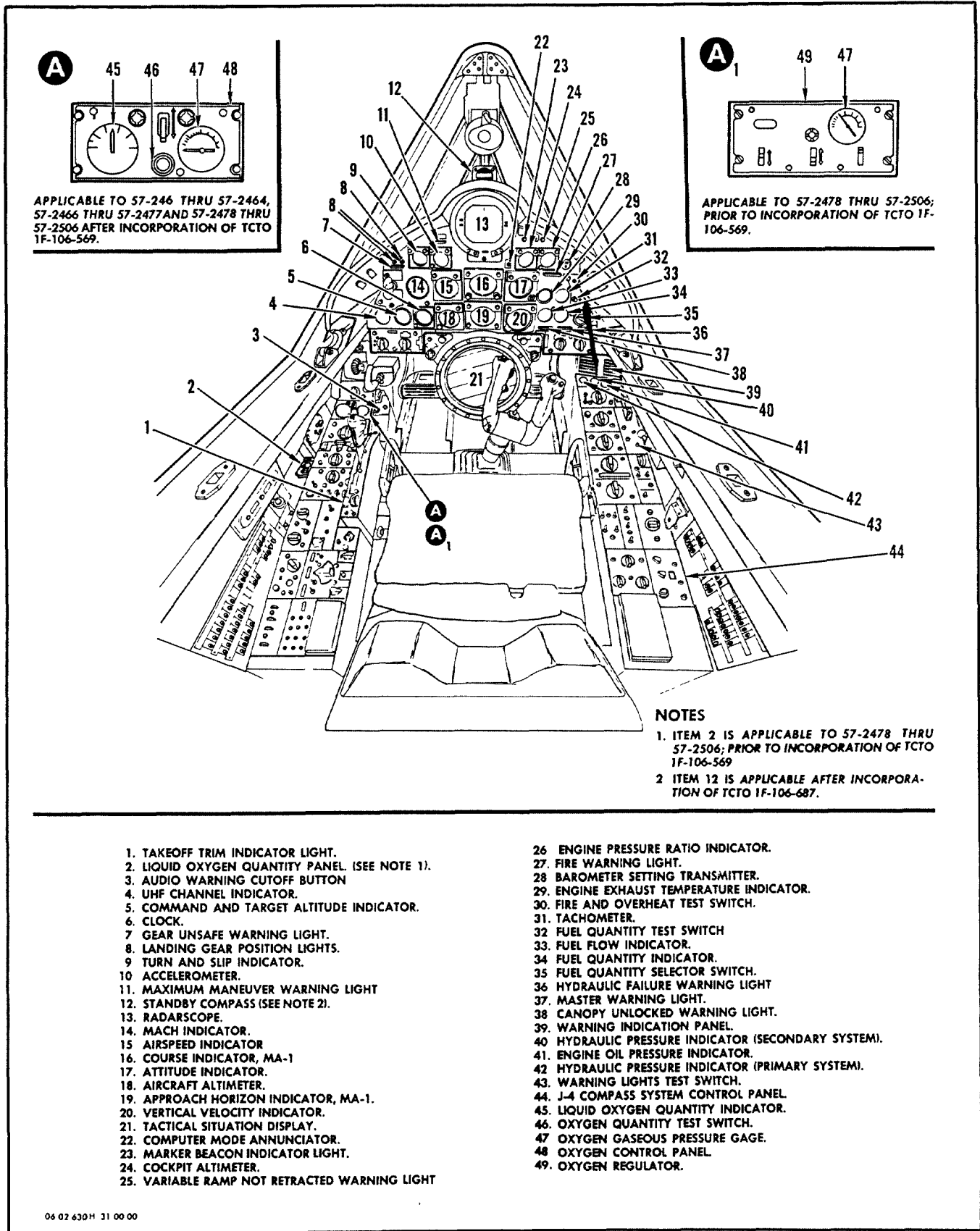

A
 APPLICABLE TO 57-246 THRU 57-2464,
 57-2466 THRU 57-2477 AND 57-2478 THRU
 57-2506 AFTER INCORPORATION OF TCTO
 1F-106-569.

A₁
 APPLICABLE TO 57-2478 THRU 57-2506;
 PRIOR TO INCORPORATION OF TCTO 1F-
 106-569.

NOTES

- 1. ITEM 2 IS APPLICABLE TO 57-2478 THRU 57-2506; PRIOR TO INCORPORATION OF TCTO 1F-106-569
- 2. ITEM 12 IS APPLICABLE AFTER INCORPORATION OF TCTO 1F-106-687.

- | | |
|---|--|
| <ul style="list-style-type: none"> 1. TAKEOFF TRIM INDICATOR LIGHT. 2. LIQUID OXYGEN QUANTITY PANEL. (SEE NOTE 1). 3. AUDIO WARNING CUTOFF BUTTON 4. UHF CHANNEL INDICATOR. 5. COMMAND AND TARGET ALTITUDE INDICATOR. 6. CLOCK. 7. GEAR UNSAFE WARNING LIGHT. 8. LANDING GEAR POSITION LIGHTS. 9. TURN AND SLIP INDICATOR. 10. ACCELEROMETER. 11. MAXIMUM MANEUVER WARNING LIGHT 12. STANDBY COMPASS (SEE NOTE 2). 13. RADARSCOPE. 14. MACH INDICATOR. 15. AIRSPEED INDICATOR 16. COURSE INDICATOR, MA-1 17. ATTITUDE INDICATOR. 18. AIRCRAFT ALTIMETER. 19. APPROACH HORIZON INDICATOR, MA-1. 20. VERTICAL VELOCITY INDICATOR. 21. TACTICAL SITUATION DISPLAY. 22. COMPUTER MODE ANNUNCIATOR. 23. MARKER BEACON INDICATOR LIGHT. 24. COCKPIT ALTIMETER. 25. VARIABLE RAMP NOT RETRACTED WARNING LIGHT | <ul style="list-style-type: none"> 26. ENGINE PRESSURE RATIO INDICATOR. 27. FIRE WARNING LIGHT. 28. BAROMETER SETTING TRANSMITTER. 29. ENGINE EXHAUST TEMPERATURE INDICATOR. 30. FIRE AND OVERHEAT TEST SWITCH. 31. TACHOMETER. 32. FUEL QUANTITY TEST SWITCH 33. FUEL FLOW INDICATOR. 34. FUEL QUANTITY INDICATOR. 35. FUEL QUANTITY SELECTOR SWITCH. 36. HYDRAULIC FAILURE WARNING LIGHT 37. MASTER WARNING LIGHT. 38. CANOPY UNLOCKED WARNING LIGHT. 39. WARNING INDICATION PANEL. 40. HYDRAULIC PRESSURE INDICATOR (SECONDARY SYSTEM). 41. ENGINE OIL PRESSURE INDICATOR. 42. HYDRAULIC PRESSURE INDICATOR (PRIMARY SYSTEM). 43. WARNING LIGHTS TEST SWITCH. 44. J-4 COMPASS SYSTEM CONTROL PANEL 45. LIQUID OXYGEN QUANTITY INDICATOR. 46. OXYGEN QUANTITY TEST SWITCH. 47. OXYGEN GASEOUS PRESSURE GAGE. 48. OXYGEN CONTROL PANEL. 49. OXYGEN REGULATOR. |
|---|--|

06 02 630H 31 00 00

Figure 10-1. Instrument Locations, F-106A
 Applicable to 57-246 thru 57-2464 and 57-2466 thru 57-2506.
 Refer to T. O. 1F-106A-2-9 for other versions

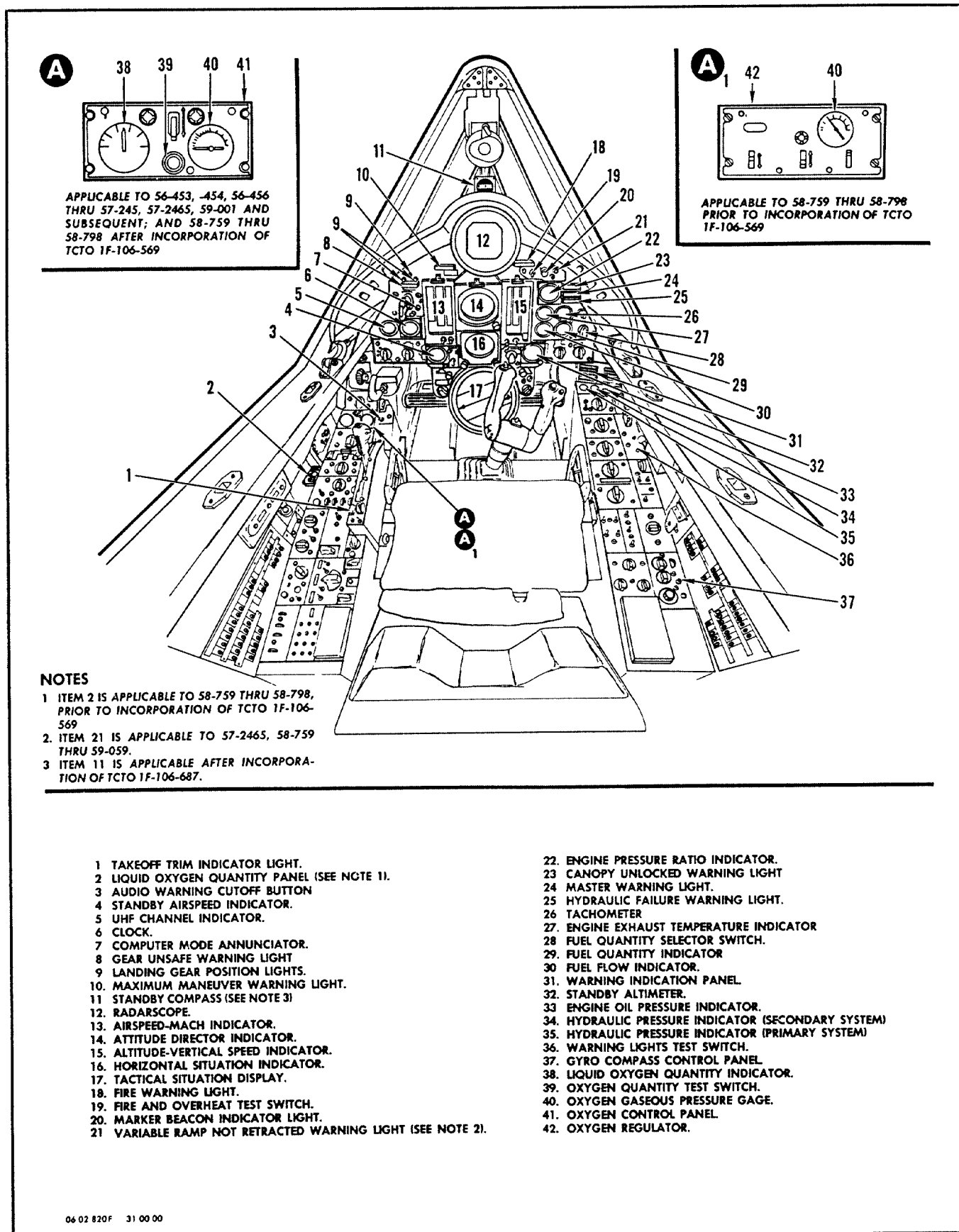
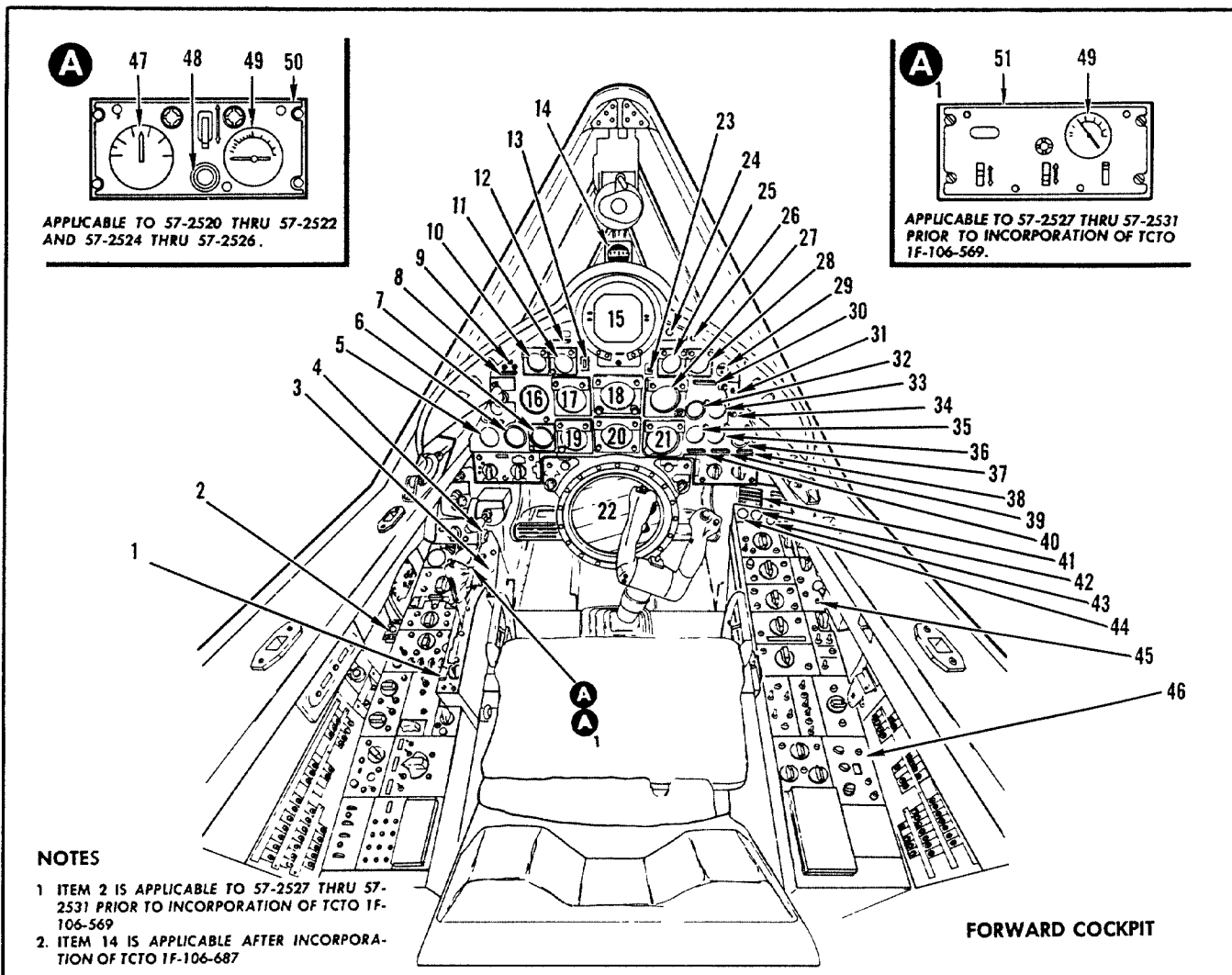

Figure 10-2. Instrument Locations, F-106A
Applicable to 56-453, -454, 56-456 thru 57-245, 57-2465, 58-759 and subsequent



NOTES

- 1 ITEM 2 IS APPLICABLE TO 57-2527 THRU 57-2531 PRIOR TO INCORPORATION OF TCTO 1F-106-569
- 2. ITEM 14 IS APPLICABLE AFTER INCORPORATION OF TCTO 1F-106-687

- | | |
|--|--|
| <ul style="list-style-type: none"> 1 TAKEOFF TRIM INDICATOR LIGHT. 2 LIQUID OXYGEN QUANTITY PANEL (SEE NOTE) 3 AUDIO WARNING CUTOFF BUTTON 4 BAILOUT SIGNAL SWITCH. 5 UHF CHANNEL INDICATOR. 6 COMMAND AND TARGET ALTITUDE INDICATOR 7 CLOCK. 8 GEAR UNSAFE WARNING LIGHT 9 LANDING GEAR POSITION LIGHTS. 10 TURN AND SLIP INDICATOR. 11 ACCELEROMETER. 12 MAXIMUM MANEUVER WARNING LIGHT. 13 BAILOUT WARNING LIGHT. 14. STANDBY COMPASS (SEE NOTE 2) 15 RADAR SCOPE. 16. MACH INDICATOR. 17. AIRSPEED INDICATOR 18. COURSE INDICATOR, MA-1. 19 AIRCRAFT ALTIMETER. 20 APPROACH HORIZON INDICATOR, MA-1. 21 VERTICAL VELOCITY INDICATOR. 22 TACTICAL SITUATION DISPLAY. 23 COMPUTER MODE ANNUNCIATOR. 24 VARIABLE RAMP NOT RETRACTED WARNING LIGHT. 25 COCKPIT ALTIMETER. 26 MARKER BEACON INDICATOR LIGHT | <ul style="list-style-type: none"> 27 ATTITUDE INDICATOR. 28 ENGINE PRESSURE RATIO INDICATOR. 29 BAROMETER SETTING TRANSMITTER. 30 FIRE WARNING LIGHT. 31 FIRE AND OVERHEAT TEST SWITCH. 32 ENGINE EXHAUST TEMPERATURE INDICATOR. 33 TACHOMETER. 34 FUEL QUANTITY TEST SWITCH. 35 FUEL FLOW INDICATOR. 36 FUEL QUANTITY INDICATOR. 37 FUEL QUANTITY SELECTOR SWITCH. 38 HYDRAULIC FAILURE WARNING LIGHT. 39 MASTER WARNING LIGHT. 40. CANOPY UNLOCKED WARNING LIGHT. 41 WARNING INDICATION PANEL 42. HYDRAULIC PRESSURE INDICATOR (SECONDARY SYSTEM). 43. ENGINE OIL PRESSURE INDICATOR. 44. HYDRAULIC PRESSURE INDICATOR (PRIMARY SYSTEM). 45. WARNING LIGHTS TEST SWITCH. 46. J-4 COMPASS SYSTEM CONTROL PANEL 47. LIQUID OXYGEN QUANTITY INDICATOR. 48 OXYGEN QUANTITY TEST SWITCH. 49. OXYGEN GASEOUS PRESSURE GAGE. 50 OXYGEN CONTROL PANEL 51 OXYGEN REGULATOR. |
|--|--|

04 02 700 1F 31 00 00

Figure 10-3. Instrument Locations, F-106B (Sheet 1 of 2)
 Applicable to 57-2520 thru -2522 and -2524 thru 57-2531.
 Refer to T.O. 1F-106A-2-9 for other versions

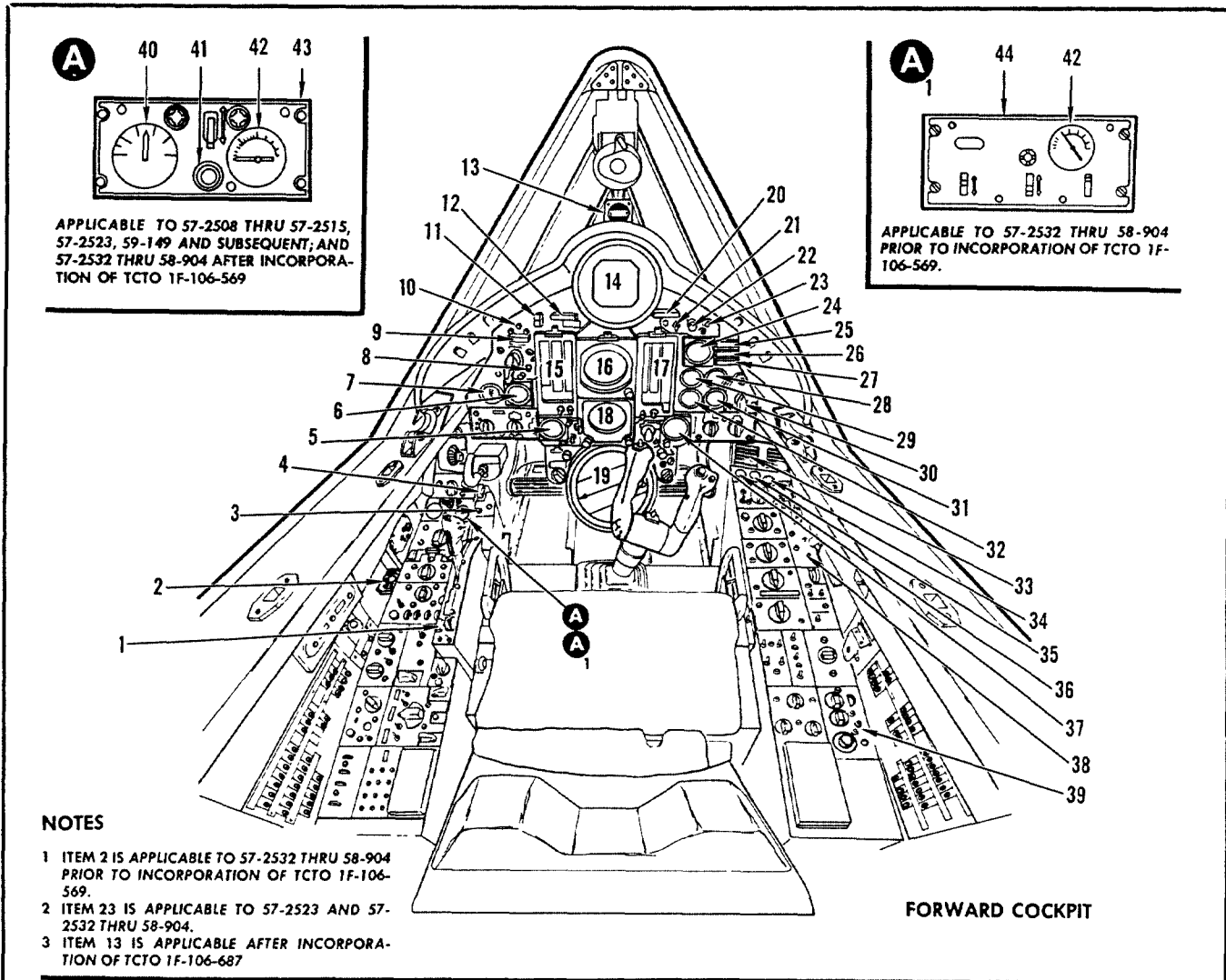

A

40 41 42 43

APPLICABLE TO 57-2508 THRU 57-2515, 57-2523, 59-149 AND SUBSEQUENT; AND 57-2532 THRU 58-904 AFTER INCORPORATION OF TCTO 1F-106-569

A

44 42

APPLICABLE TO 57-2532 THRU 58-904 PRIOR TO INCORPORATION OF TCTO 1F-106-569.

NOTES

- 1 ITEM 2 IS APPLICABLE TO 57-2532 THRU 58-904 PRIOR TO INCORPORATION OF TCTO 1F-106-569.
- 2 ITEM 23 IS APPLICABLE TO 57-2523 AND 57-2532 THRU 58-904.
- 3 ITEM 13 IS APPLICABLE AFTER INCORPORATION OF TCTO 1F-106-687

- | | |
|--|--|
| <ul style="list-style-type: none"> 1 TAKEOFF TRIM INDICATOR LIGHT 2 LIQUID OXYGEN QUANTITY PANEL (SEE NOTE 1) 3 AUDIO WARNING CUTOFF BUTTON 4 BAILOUT SIGNAL SWITCH 5 STANDBY AIRSPEED INDICATOR 6 CLOCK. 7 UHF CHANNEL INDICATOR. 8 COMPUTER MODE ANNUNCIATOR. 9 GEAR UNSAFE WARNING LIGHT. 10 LANDING GEAR POSITION LIGHTS. 11 BAILOUT WARNING LIGHT. 12 MAXIMUM MANEUVER WARNING LIGHT. 13 STANDBY COMPASS (SEE NOTE 3) 14 RADARSCOPE. 15 AIRSPEED-MACH INDICATOR. 16 ATTITUDE DIRECTOR INDICATOR. 17 ALTITUDE-VERTICAL SPEED INDICATOR. 18 HORIZONTAL SITUATION INDICATOR. 19 TACTICAL SITUATION DISPLAY. 20 FIRE WARNING LIGHT. 21 FIRE AND OVERHEAT TEST SWITCH. 22 MARKER BEACON INDICATOR LIGHT. | <ul style="list-style-type: none"> 23 VARIABLE RAMP NOT RETRACTED WARNING LIGHT (SEE NOTE 2.) 24 ENGINE PRESSURE RATIO INDICATOR. 25 CANOPY UNLOCKED WARNING LIGHT. 26 MASTER WARNING LIGHT 27 HYDRAULIC FAILURE WARNING LIGHT. 28 TACHOMETER. 29 ENGINE EXHAUST TEMPERATURE INDICATOR. 30 FUEL QUANTITY SELECTOR SWITCH. 31 FUEL QUANTITY INDICATOR. 32 FUEL FLOW INDICATOR 33 WARNING INDICATION PANEL 34 ENGINE OIL PRESSURE INDICATOR 35 HYDRAULIC PRESSURE INDICATOR (SECONDARY SYSTEM). 36 HYDRAULIC PRESSURE INDICATOR (PRIMARY SYSTEM) 37 STANDBY ALTIMETER. 38 WARNING LIGHTS TEST SWITCH. 39 GYRO COMPASS CONTROL PANEL 40 LIQUID OXYGEN QUANTITY INDICATOR. 41 OXYGEN QUANTITY TEST SWITCH. 42 OXYGEN GASEOUS PRESSURE GAGE. 43 OXYGEN CONTROL PANEL 44 OXYGEN REGULATOR. |
|--|--|

FORWARD COCKPIT

06 02 821 1D 31 00 00

Figure 10-3. Instrument Locations, F-106B (Sheet 2 of 2)
 Applicable to 57-2520 thru -2522 and -2524 thru 57-2531.
 Refer to T. O. 1F-106A-2-9 for other versions

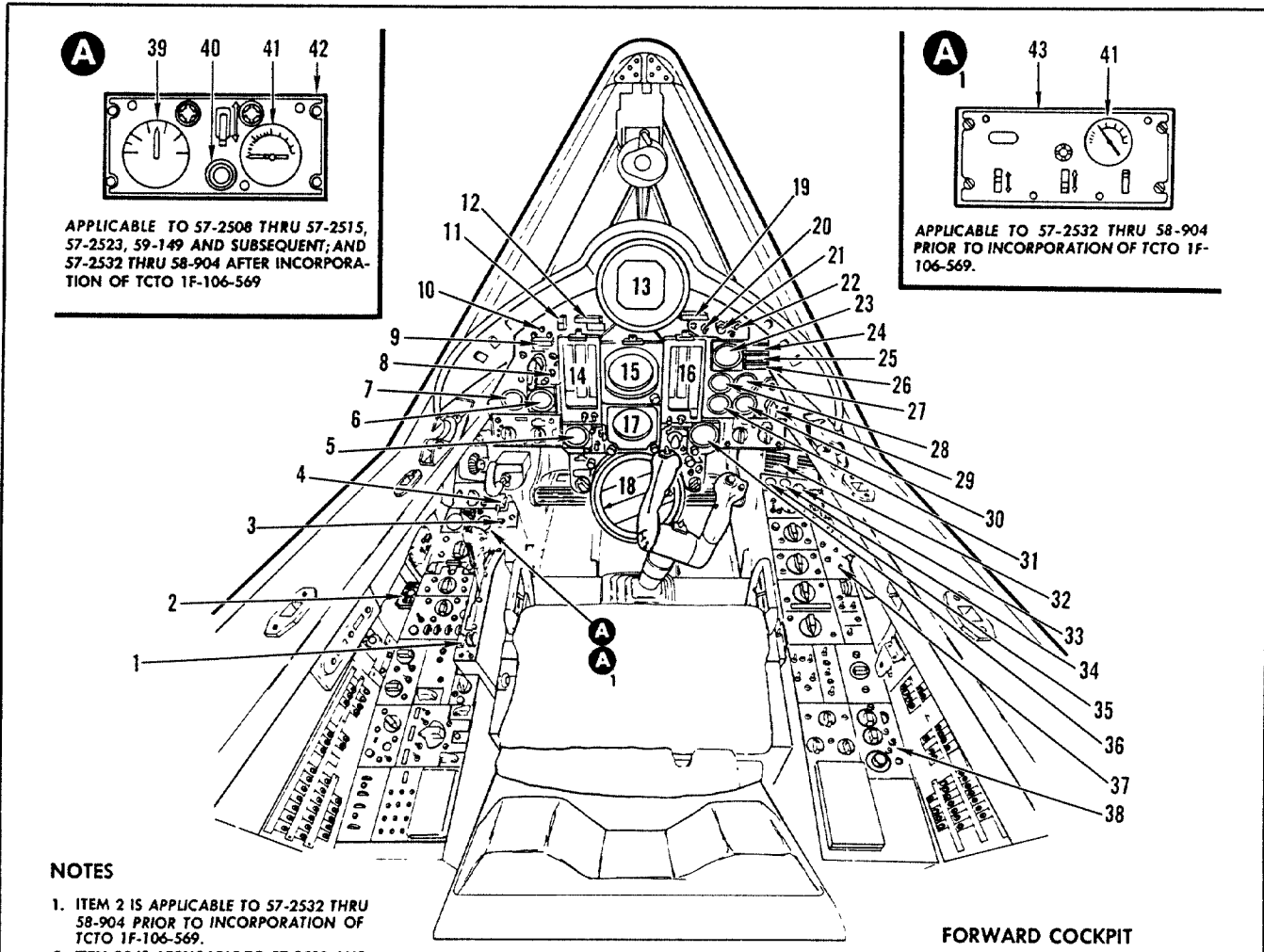

A

39 40 41 42

APPLICABLE TO 57-2508 THRU 57-2515, 57-2523, 59-149 AND SUBSEQUENT, AND 57-2532 THRU 58-904 AFTER INCORPORATION OF TCTO 1F-106-569

A

43 41

APPLICABLE TO 57-2532 THRU 58-904 PRIOR TO INCORPORATION OF TCTO 1F-106-569.

NOTES

- 1. ITEM 2 IS APPLICABLE TO 57-2532 THRU 58-904 PRIOR TO INCORPORATION OF TCTO 1F-106-569.
- 2. ITEM 22 IS APPLICABLE TO 57-2523 AND 57-2532 THRU 58-904.

FORWARD COCKPIT

- | | |
|--|---|
| <ul style="list-style-type: none"> 1. TAKEOFF TRIM INDICATOR LIGHT. 2. LIQUID OXYGEN QUANTITY PANEL (SEE NOTE 1). 3. AUDIO WARNING CUTOFF BUTTON. 4. BAILOUT SIGNAL SWITCH 5. STANDBY AIRSPEED INDICATOR. 6. CLOCK 7. UHF CHANNEL INDICATOR. 8. COMPUTER MODE ANNUNCIATOR 9. GEAR UNSAFE WARNING LIGHT. 10. LANDING GEAR POSITION LIGHTS. 11. BAILOUT WARNING LIGHT 12. MAXIMUM MANEUVER WARNING LIGHT 13. RADARSCOPE. 14. AIRSPEED-MACH INDICATOR 15. ATTITUDE DIRECTOR INDICATOR. 16. ALTITUDE-VERTICAL SPEED INDICATOR. 17. HORIZONTAL SITUATION INDICATOR. 18. TACTICAL SITUATION DISPLAY. 19. FIRE WARNING LIGHT. 20. FIRE AND OVERHEAT TEST SWITCH. 21. MARKER BEACON INDICATOR LIGHT. 22. VARIABLE RAMP NOT RETRACTED WARNING LIGHT (SEE NOTE 2.) | <ul style="list-style-type: none"> 23. ENGINE PRESSURE RATIO INDICATOR 24. CANOPY UNLOCKED WARNING LIGHT. 25. MASTER WARNING LIGHT. 26. HYDRAULIC FAILURE WARNING LIGHT. 27. TACHOMETER 28. ENGINE EXHAUST TEMPERATURE INDICATOR. 29. FUEL QUANTITY SELECTOR SWITCH. 30. FUEL QUANTITY INDICATOR. 31. FUEL FLOW INDICATOR. 32. WARNING INDICATION PANEL 33. ENGINE OIL PRESSURE INDICATOR. 34. HYDRAULIC PRESSURE INDICATOR (SECONDARY SYSTEM). 35. HYDRAULIC PRESSURE INDICATOR (PRIMARY SYSTEM). 36. STANDBY ALTIMETER. 37. WARNING LIGHTS TEST SWITCH 38. GYRO COMPASS CONTROL PANEL 39. LIQUID OXYGEN QUANTITY INDICATOR. 40. OXYGEN QUANTITY TEST SWITCH. 41. OXYGEN GASEOUS PRESSURE GAGE. 42. OXYGEN CONTROL PANEL. 43. OXYGEN REGULATOR. |
|--|---|

Figure 10-4. Instrument Locations, F-106B (Sheet 1 of 2)
 Applicable to 57-2508 thru 57-2515, 57-2523, 57-2532 and subsequent

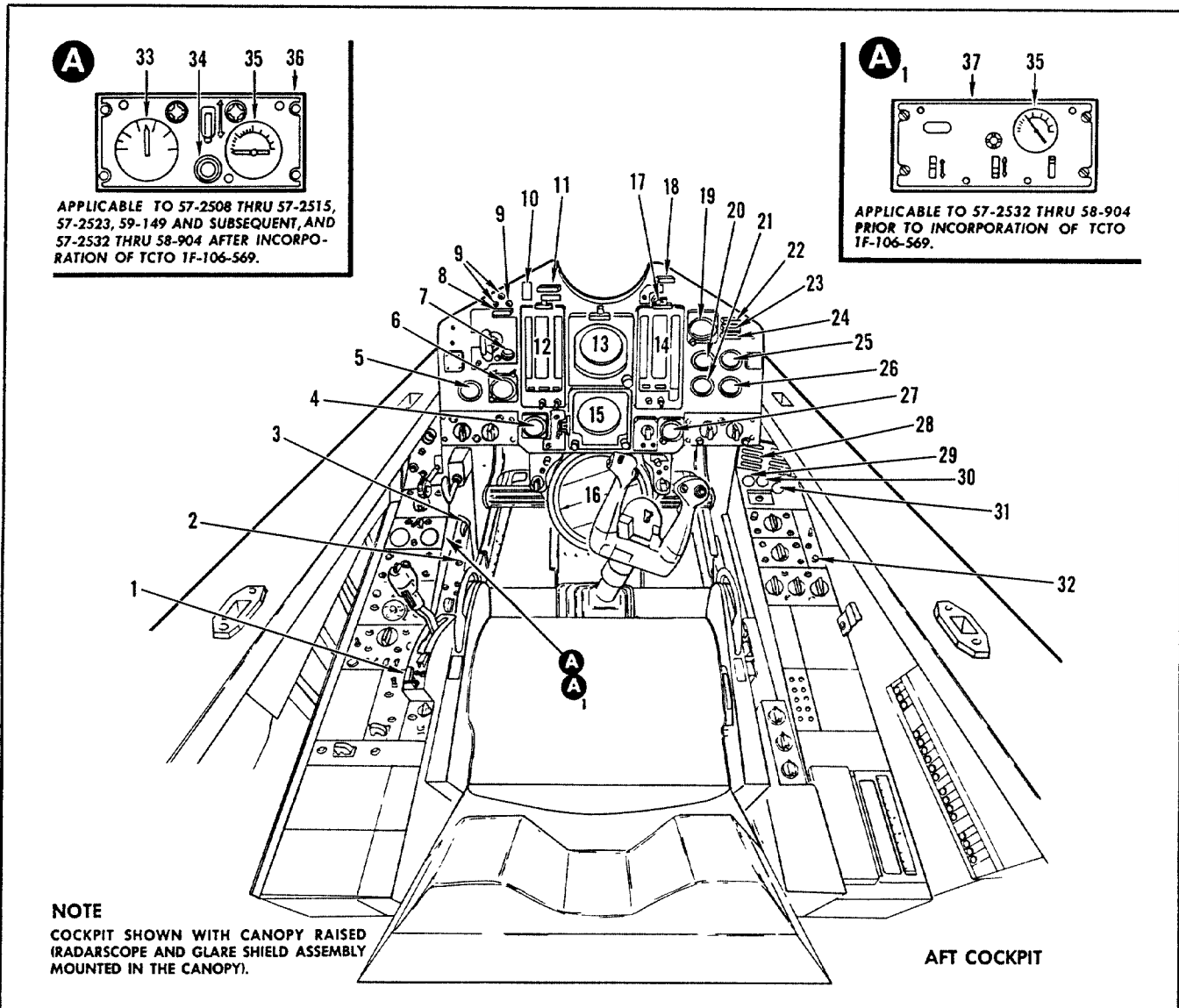

1. TAKEOFF TRIM INDICATOR LIGHT
2. AUDIO WARNING CUTOFF BUTTON.
3. BAILOUT SIGNAL SWITCH.
4. STANDBY AIRSPEED INDICATOR
5. UHF CHANNEL INDICATOR.
6. CLOCK.
7. COMPUTER MODE ANNUNCIATOR.
8. GEAR UNSAFE WARNING LIGHT.
9. LANDING GEAR POSITION LIGHTS
10. BAILOUT WARNING LIGHT.
11. MAXIMUM MANEUVER WARNING LIGHT
12. AIRSPEED-MACH INDICATOR.
13. ATTITUDE DIRECTOR INDICATOR.
14. ALTITUDE-VERTICAL SPEED INDICATOR
15. HORIZONTAL SITUATION INDICATOR.
16. TACTICAL SITUATION DISPLAY.
17. MARKER BEACON INDICATOR LIGHT.
18. FIRE WARNING LIGHT.
19. ENGINE PRESSURE RATIO INDICATOR

20. ENGINE EXHAUST TEMPERATURE INDICATOR.
21. FUEL FLOW INDICATOR.
22. CANOPY UNLOCKED WARNING LIGHT
23. MASTER WARNING LIGHT.
24. HYDRAULIC FAILURE WARNING LIGHT.
25. TACHOMETER.
26. FUEL QUANTITY INDICATOR.
27. STANDBY ALTIMETER.
28. WARNING INDICATION PANEL.
29. HYDRAULIC PRESSURE INDICATOR (PRIMARY SYSTEM)
30. HYDRAULIC PRESSURE INDICATOR (SECONDARY SYSTEM)
31. ENGINE OIL PRESSURE INDICATOR.
32. WARNING LIGHTS TEST SWITCH.
33. LIQUID OXYGEN QUANTITY INDICATOR
34. OXYGEN QUANTITY TEST SWITCH.
35. OXYGEN GASEOUS PRESSURE GAGE.
36. OXYGEN CONTROL PANEL.
37. OXYGEN REGULATOR.

06 02 821 2C 31 00 00

Figure 10-4. Instrument Locations, F-106B (Sheet 2 of 2)
Applicable to 57-2508 thru 57-2515, 57-2523, 57-2532 and subsequent

ENGINE INSTRUMENTS

10-3. GENERAL.

The engine instruments are provided to visually indicate the operating condition of the engine, and to show the fuel quantity and rate of fuel flow. Warning lights are

installed to provide visual indication of fuel, oil, or engine system malfunction. Refer to T.O. 1F-106A-2-9 for a complete list of engine instruments and their function.

FUEL QUANTITY INDICATING SYSTEM

10-4. GENERAL.

The fuel quantity indicating system indicates the amount of fuel in pounds, available in the integral fuel tanks. The system consists of an indicator, a fuel tank selector switch, 19 tank probes and a compensator unit. Indications of total fuel, fuselage tank only, left wing tanks or right wing tanks is made possible by manual selections of the fuel quantity selector switch. The compensator unit

insures correct fuel quantity indications regardless of temperature and dielectric variations in the fuel. The pilot does not have a fuel quantity indication for fuel in the external fuel tanks. A fuel low warning light for each wing system is located on the warning indication panel. Warning lights illuminate when the fuel level in the respective No. 3 tank drops below 88 gallons. Refer to T.O. 1F-106A-2-9 for complete coverage of this system.

POWER SUPPLY SYSTEM INSTRUMENTS

10-5. GENERAL.

The power supply system instruments indicate the amount of hydraulic, pneumatic, and electrical power available to operate the various systems and components of the

airplane. Warning lights are also provided to quickly inform the pilot of any power supply system failure. Refer to T.O. 1F-106A-2-9 for a complete list of the power supply system instruments and their function.

Section XI

ELECTRICAL SYSTEMS

<i>Contents</i>	<i>Page</i>
General	11-1
DC Electrical Power Supply Systems	11-1
AC Electrical Power Supply Systems	11-3
AWCIS Electrical Power Supply System	11-5
Power Distribution	11-5
Lighting Systems	11-5
Master Warning System	11-6
Fire and Overheat Detection Systems	11-7

GENERAL

11-1. DESCRIPTION.

The airplane electrical systems covered in this section consist of the following: ac and dc power supply systems, power distribution, lighting systems, master warning system, and fire and overheat detection systems. These systems are discussed briefly here; detailed information, plus detailed power loading, will be found in T.O. 1F-106A-2-10.

11-2. POWER LOADING DATA.

Power loading data provides a means of determining that voltage and frequency outputs of generating systems remain within specified limits when electrical loads are suddenly increased or decreased. An external unit is used to apply external loads and record fluctuations in generator voltage and frequency during tests. For correct operation, fluctuations must not exceed specific tolerances and must return to normal range in a specific length of time when electrical loads vary. Refer to T.O. 1F-106A-2-10 for detailed information and procedures to check out the electrical systems.

DC ELECTRICAL POWER SUPPLY SYSTEMS

11-3. GENERAL.

A dc generator or an emergency power package supplies 28-volt dc power to electrical buses. The dc generator is attached to and driven by a constant speed drive remote gearbox. The gearbox, in turn, is driven by the engine. A battery is part of the dc system, but is a component of

the emergency dc power package. The emergency dc power package supplies power to dc essential buses if the dc generator fails. Components in the system include a dc generator, a dc control panel, and various switches and relays with specific functions. The dc control panel regulates dc generator output to approximately 28 volts.

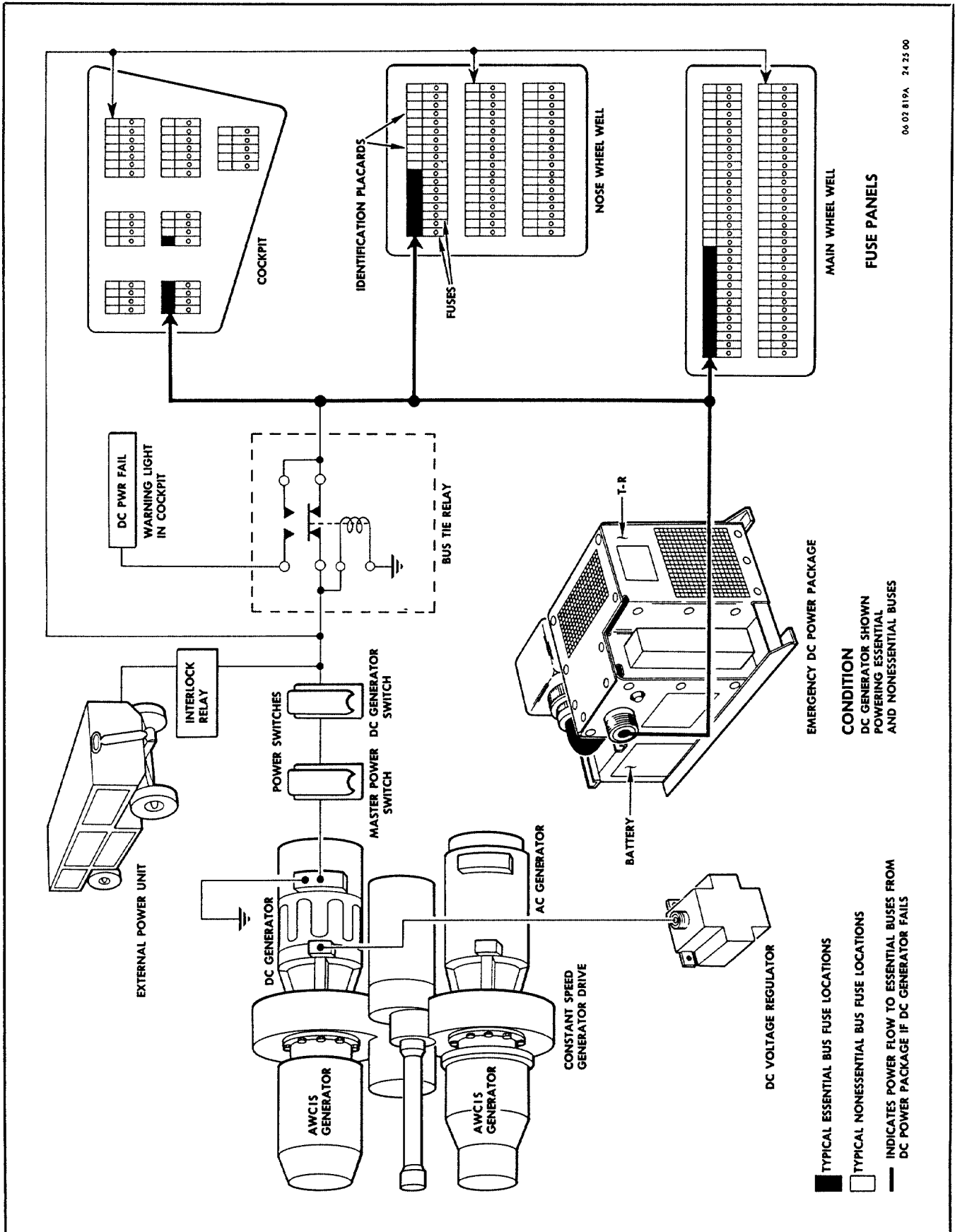

06 02 819A 24 25 00

Figure 11-1. DC Electrical Power System Diagram

A series connected master electrical power switch and dc generator control switch control dc generator output. These switches are located on the cockpit left console. A warning light on the cockpit warning indication panel, illuminates to indicate power failure. External power receptacles are provided to connect external power to electrical buses. See figure 11-1 for a block diagram of the dc electrical power supply system. Refer to T.O. 1F-106A-2-10 for detailed information on dc electrical systems.

11-4. DC EMERGENCY POWER PACKAGE AND CANOPY POWER PACKAGE.

An emergency dc power package in the nose wheel well supplies emergency power to the dc essential bus. The power package consists of a 15 ampere-hour, 18 cell, silver zinc storage battery and a transformer-rectifier

(T-R). The T-R serves a dual purpose. Normally, it supplies a trickle charge to the battery to keep the battery fully charged. In the event the dc generator fails, T-R output current increases and the T-R and battery in parallel supply power to the dc essential bus. If in addition, the primary ac generator fails, the T-R and battery in parallel power dc essential bus while airspeed is above 280 (± 5) knots IAS. Below 280 (± 5) knots IAS, the T-R is cut off and the battery powers dc essential bus. When the master power switch is ON, the emergency power package powers the dc essential bus only.

11-5. An electrically operated canopy receives power from the dc nonessential bus. A canopy power package supplies power to operate the canopy in emergencies when dc nonessential bus are not energized. The canopy power package, consisting of a transformer-rectifier and a three ampere-hour, 17 cell silver-zinc storage battery, is located just forward of the emergency dc power package.

AC ELECTRICAL POWER SUPPLY SYSTEMS

11-6. GENERAL.

The ac power supply system furnishes electrical power to ac essential and nonessential buses. An emergency system supplies ac essential buses if the normal system fails. Refer to paragraph 11-7 for a brief description of the emergency system. See figure 11-2 for a block diagram of the ac power supply system. Following are main components of the ac power supply system:

COMPONENT	FUNCTION
AC Generator	Supplies 115/200-v, three-phase, 400-cps ac power.
Static Exciter Voltage Regulator	Regulates ac generator output voltage to 115 (± 2) volts.
Frequency Controller	Holds generator frequency to 400 (± 2) cycles-per-second.
Instrument Transformer	Supplies 26-v ac power to instruments requiring this voltage.
AC Control Panel	Provides over-voltage and under-voltage protection for ac-operated equipment.
AC Power Control	Controls ac generator output.

The generator is attached to and is driven by a constant speed drive remote gearbox; the gearbox is driven by the

engine. A frequency controller holds generator frequency at 400 cps by electrically trimming a speed governor in the remote gearbox. A master power switch and an ac generator control switch, connected in series, control generator output. The master power switch is located on the left console and the generator switch is located on the right console. A power failure light, located on the warning indication panel, illuminates when ac system output fails. An external power receptacle is provided to connect external power to electrical buses.

11-7. AC EMERGENCY POWER SUPPLY SYSTEM.

The ac emergency power supply system furnishes electrical power to ac essential buses and the dc emergency power package if the normal ac system fails in flight. Power is supplied by a 115/200-v, three-phase, 400-cps generator. The generator is driven by two hydraulic motors that are powered by hydraulic pressure from the secondary hydraulic system. An electrically operated solenoid valve controls hydraulic pressure to the hydraulic motors. The ac emergency system is automatically activated under the following conditions:

- a. AC power failure light illuminated.
- b. Main landing gear up and locked.
- c. Secondary hydraulic system in operation.

Once activated, the system remains activated after the landing gear is extended. A test switch is used to operationally check the ac emergency system on the ground during maintenance operations. Refer to T.O. 1F-106A-2-10 for detailed information on the ac power supply systems.

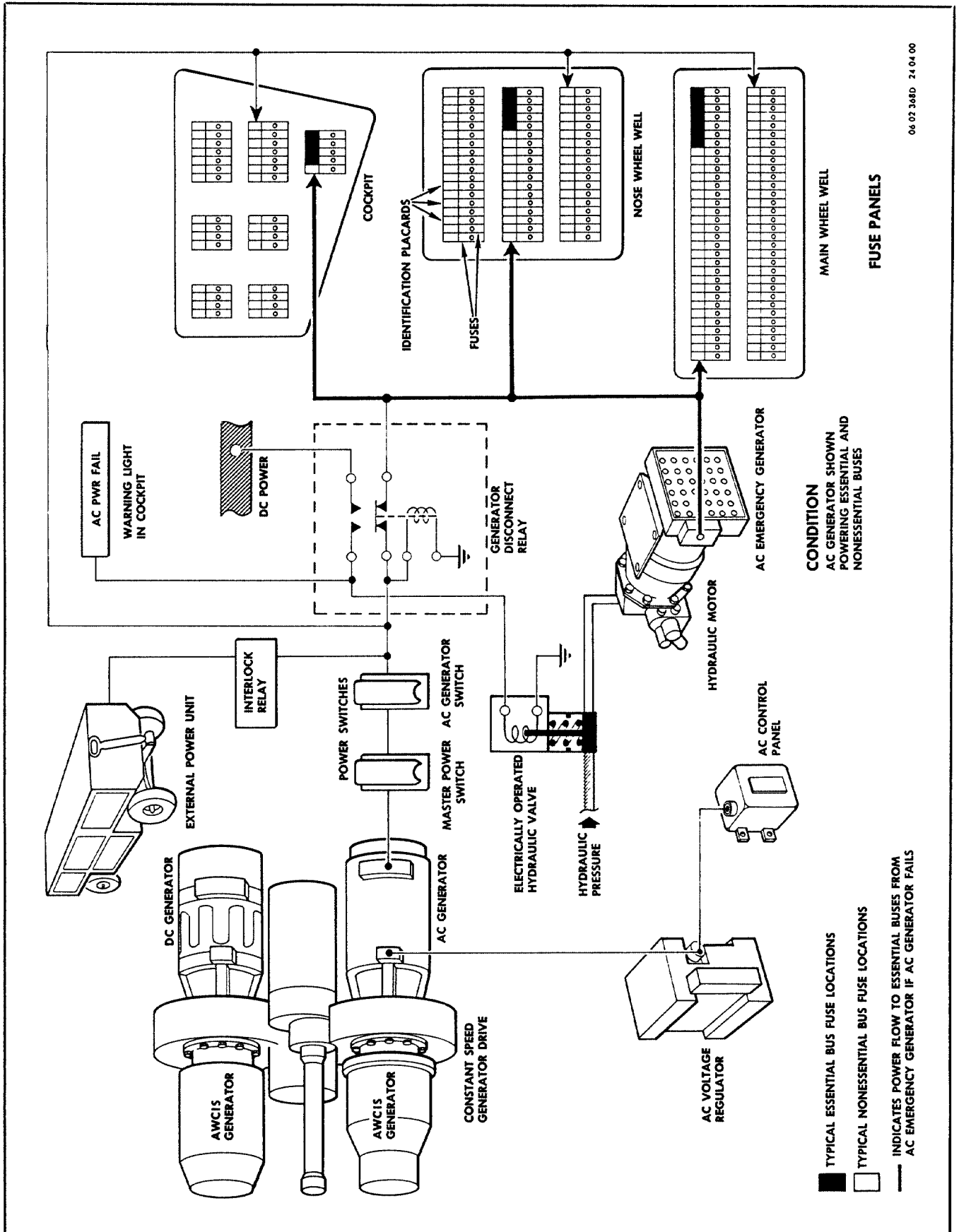

Figure 11-2. AC Electrical Power Supply System Diagram

AWCIS ELECTRICAL POWER SUPPLY SYSTEM

11-8. GENERAL.

Two generators, driven at constant speed by the constant speed drive remote gearbox, supply AWCIS power. These generators are installed on pads "C" and "D" of the remote gearbox. The generator mounted on pad "C"

of the remote gearbox supplies +300, +150, and -140 volts dc. The generator mounted on pad "D" supplies 28-volts dc; 115-volts, single-phase, 1600-cps ac; and 115-volts, 400-cps, three-phase ac. These generators supply power to the AWCIS that is described in T.O. 1F-106A-2-15 and T.O. 1F-106A-2-27.

POWER DISTRIBUTION

11-9. GENERAL.

AC and dc power for electrical systems is distributed through fuses from power buses located at the back of the fuse panels. The power buses are designated as essential and nonessential. Airplane systems necessary for continuation of flight receive power from essential buses. Normally the ac and dc generating systems energize their respective essential and nonessential power buses. If the ac generating system fails, an emergency ac generator supplies power to energize ac essential buses. If the dc generating system fails, the dc emergency power package energizes dc essential power buses.

11-10. Fuses, mounted in receptacles of fuse panels, protect electrical systems from excessive current. Fuse panels are located in the cockpit, in the main wheel well and in the nose wheel well. The fuse receptacles are placarded with the fuse name and amperage. A color coding system is used to identify each fuse as to type of power, amount of voltage and whether the fuse is on the essential or non-essential bus. The amperage rating of each fuse is marked on the fuse. A plunger protrudes through a window in the fuse to indicate when the fuse is burned out. Refer to T.O. 1F-106A-2-10 for detailed information on power distribution and a list of all fuses and their location.

LIGHTING SYSTEMS

11-11. GENERAL.

The airplane lighting systems are divided into two groups consisting of exterior lights and interior lights. The exterior lights consist of position lights, landing lights, and taxi lights. The interior lights consist of the instrument panel lights, console panel lights, augmentation lights, cockpit red floodlights, thunderstorm lights, and map reading lights.

11-12. POSITION LIGHTS.

Position lights consist of left and right wing tip lights, vertical fin light, and upper and lower fuselage lights. These position lights are connected to the ac essential bus and are controlled by a selector switch on the "LIGHT CONT" switch panel located on the cockpit right console. Placing the switch to "FORM" illuminates the position lights for formation lighting. The lights can be dimmed when formation lighting is selected. Placing the selector switch to "NAV" illuminates the wing tip and

vertical fin lights, and extends and illuminates the red portion of the upper and lower fuselage lights. The fuselage lights then become rotating beacon lights. The position lights cannot be dimmed when navigation lighting is selected. Refer to T.O. 1F-106A-2-10 for detailed information on this system.

11-13. LANDING LIGHTS.

The landing lights are installed on the inner surface of the main landing gear doors. The landing lights illuminate only when the main landing gear is down and locked due to electrical control power being routed through the landing gear down and locked switches. Each light is attached to the door structure by bolts which may be loosened to permit adjustment of the light. The landing lights are controlled through the taxi and landing lights control switch just above the pilot's left console panel. Positioning the switch to the "LANDING LIGHTS" position connects 28-volt dc power from the "TAXI-LDG CONT" fuse on the cockpit left fuse

panel to the landing light control relays in the main wheel wells. When the main landing gear is down and locked, power from the "RH LDG LT" and "LH LDG LT" fuses on the main wheel well fuse panel is connected through the relays to illuminate the landing lights. Refer to T.O. 1F-106A-2-10 for complete coverage on this system.

11-14. TAXI LIGHT.

The taxi light is installed on the forward inner surface of the nose landing gear door. The light will illuminate only when the nose landing gear is down and locked due to electrical control power being routed through the gear down and locked switch. The light is attached to the door structure by bolts which may be loosened to permit adjustment of the light. The light is controlled through the taxi and landing lights control switch just above the pilots left console panel. The switch has three positions, "TAXI LIGHT" — "OFF" — "LANDING LIGHTS" and can operate either the taxi light, or landing lights separately, but not both simultaneously. Refer to T.O. 1F-106A-2-10 for complete coverage on this system.

11-15. INSTRUMENT PANEL LIGHTS.

The instrument panel lights are located on the pilot's instrument panel and are controlled by a powerstat located on the cockpit right subconsole panel. The powerstat receives 115-volt ac power from the ac essential bus. The powerstat is an auto transformer whose output voltage may be varied from 14 volts to 28 volts. Instrument and control panel light intensity is varied from dim to full bright by rotating the powerstat knob from extreme counterclockwise to extreme clockwise. Refer to T.O. 1F-106A-2-10 for complete coverage on this system.

11-16. AUGMENTATION LIGHTS.

Applicable to F-106A airplanes 56-453, -454, 56-456 thru 57-245, 57-2465, 58-759 and subsequent; and F-106B airplanes 57-2508 thru 57-2515, 57-2523, 57-2532 and subsequent. Instruments and instrument panels are illuminated either by red lamps in panels and instrument faces, or by two high intensity ambient augmentation lights behind right and left glare shields. An "INST PNL" switch on the "LIGHT CONT" panel selects red instrument lights in the "PRI" position or white augmentation lights in the "AUG" position. Augmentation lights reduce daytime glare in instruments and provide brilliant instrument illumination during nuclear explosions. Rotating the "INST

PNL" powerstat knob clockwise turns on the lights and increases their brightness in ten steps. The lights operate from the 115-volt ac essential bus through "INST PNL PRIMARY" and "INST PNL SECONDARY" fuses in the cockpit right fuse panel.

11-17. CONSOLE LIGHTS.

The console panel lights are located on the pilot's console panels and on the left and right switch panels. The output of a powerstat on the lighting control panel furnishes the power and controls the intensity of the panel lights. The powerstat is an autotransformer which is powered from the 115-volt ac essential bus. The output voltage may be varied from 14 volts to 28 volts by rotating the powerstat knob. Refer to T.O. 1F-106A-2-10 for complete coverage on this system.

11-18. COCKPIT RED FLOODLIGHTS.

The cockpit red floodlights consist of lights on the left and right sides of the cockpit below the windshield, and beneath the glare shield. The lights receive 115-volt power from the ac nonessential bus and are controlled by a powerstat. The powerstat voltage may be varied from 14 volts to 28 volts for light intensity control. In the event of ac essential power failure (ac generator and ac emergency generator inoperative), some floodlights are transferred to the 28-volt dc essential bus. Refer to T.O. 1F-106A-2-10 for complete coverage on this system.

11-19. THUNDERSTORM LIGHTS.

Thunderstorm lights are installed on the left and right sides of the cockpit below the windshield and below the glare shield. The lights are controlled by a switch installed on the light control panel and receive power from the 28-volt dc nonessential bus. Placing the switch to "ON" illuminates the thunderstorm lights. The thunderstorm light circuit is connected electrically to the master warning dimming circuit so that warning lights are always bright when thunderstorm lights are illuminated. *On F-106B airplanes*, thunderstorm lights are controlled from the forward cockpit. Refer to T.O. 1F-106A-2-10 for complete coverage on this system.

11-20. MAP READING LIGHT.

A map reading light is located in the cockpit (forward and aft cockpit *on F-106B airplanes*). The light is controlled by a two position switch and receives power from the 28-v dc essential bus.

MASTER WARNING SYSTEM

11-21. GENERAL.

The master warning system provides visual indication when a system is not up to operational or selected require-

ments. Warning lights are located in the cockpit on a warning indication panel, on the main instrument panel and on switch control panels. Each light is labelled for

identification to the corresponding system. A master warning light is located on the main instrument panel. This light illuminates to draw attention to a system malfunction when any light on the warning indication panel illuminates. The master warning light is a press-to-reset light. Momentarily depressing the light will extinguish the light until another system malfunction occurs. The lights on the warning indication panel remain illuminated until the corresponding system returns to normal operation. Some warning lights are push-to-test or push-to-dim types. A warning light test switch (button-type) is located on the cockpit right-hand console. Depressing this button illuminates all warning lights, except those that are the push-to-test or push-to-dim type. Illumination of warning lights prior to engine starting and subsequent to engine shutdown is normal. Warning lights may be dimmed by momentarily operating the "bright-dim" switch to "DIM" providing the flight instrument lights are on and the

thunderstorm lights are off. The lights can be restored to bright by momentarily operating the "bright-dim" switch to "BRT." The warning light will automatically return to bright if the flight instrument lights are turned off or the thunderstorm lights are turned on. The warning lights will also return to bright when there is a power interruption. The purpose of these precautions is to insure that the warning lights are never left on "DIM" when the general lighting intensity is increased. *Applicable to F-106B airplanes*, master warning systems are installed in forward and aft cockpits. Warning signals are connected in parallel to both cockpits and warning lights illuminate in forward and aft cockpits at the same time. Failure of a warning light in one cockpit does not affect the operation of the corresponding warning light in the other cockpit. Dimming of warning lights is independent in each cockpit. Refer to T.O. 1F-106A-2-10 for complete coverage of this system.

FIRE AND OVERHEAT DETECTION SYSTEMS

11-22. GENERAL.

The fire and overheat detection system provides visual indication if a fire or overheat condition exists around the engine. *Applicable to F-106A airplanes 57-246, 57-2453, 57-2455 thru 57-2465, and F-106B airplanes 57-2515 thru 57-2522 prior to incorporation of TCTO 1F-106-652.* Components for overheat detection are as follows: overheat detect loop, overheat detect relay, overheat detector box and an overheat detector flasher. Components for fire detection are as follows: fire detect loop, fire detect relay, and a fire detector box. A fire warning light and a test switch are common to the fire and overheat detection system. *On F-106A airplanes*, the light and test switch are located on the main instrument panel. *On F-106B airplanes*, the light is located on the main instrument panel in the forward and aft cockpit. The test switch is located in the forward cockpit only. Electrical power for fire and overheat detection is taken from the 28-v dc essential bus thru a "FIRE OVHT WARN" fuse on the main wheel well fuse panel. Electrical power for the test circuit is taken from the 28-v dc essential bus through a "FIRE OVHT TEST" fuse on the cockpit right fuse panel. The fire warning light is connected to the master warning dimming relay for dimming purposes. The fire detect loop is installed around the inner perimeter of the fuselage in the engine accessory section. The overheat loop is installed around the inner perimeter of the fuselage in the afterburner section. When an overheat condition exists, the overheat detect loop completes a circuit through the overheat detector box to the overheat detector flasher. The overheat detector flasher intermittently illuminates the "FIRE" warning light. A fire condition is detected in a similar manner. When a fire condition exists, the fire

detect loop completes a circuit through the fire detector box directly to the "FIRE" warning light. Under fire condition, the warning light illumination is steady. A failure of the flasher has no effect on the warning light, but causes the overheat function of the warning light to be inoperative. The test switch is used to test the fire detection system. Placing the test switch to "OVHT" energizes the overheat detect relay which in turn causes the fire warning light to flash. Placing the test switch to "FIRE," energizes the fire detect relay which results in steady illumination of the fire warning light. Refer to T.O. 1F-106A-2-10 for detailed information and operation of this system.

11-23. *Applicable to F-106A airplanes 56-453, 56-454, 56-456 thru 57-245, 57-2454, 57-2466 and subsequent; and 57-246, 57-2453, 57-2455 thru 57-2465 after incorporation of TCTO 1F-106-652. Applicable to F-106B airplanes 57-2508 thru 57-2515, 57-2523 and subsequent; and 57-2516 thru 57-2522 after incorporation of TCTO 1F-106-652.* The fire and overheat detection system is composed of two separate overheat detection circuits. Overheat condition is indicated when continuity in either circuit is completed. Fire condition is indicated only when both circuits are completed. Each overheat detection circuit consist of an overheat detect loop, a loop detector box, a loop test relay and a loop indication relay. Components common to both circuits are a fire warning relay, an overheat flasher, a fire warning light and a test switch. *On F-106A airplanes*, the light and test switch are located on the main instrument panel. *On F-106B airplanes*, the light is located on the main instrument panel in the forward and aft cockpit. The test switch is located in the forward cockpit only. *Applicable to all airplanes*, the

overheat detect circuits are designated as Loop No. 1 and Loop No. 2. The detector loops are located around the inner perimeter of the fuselage, extending from the engine accessory compartment through the length of the afterburner section. Electrical power for the detection system is taken from the 28-v dc essential bus through fuses located on the main wheel well fuse panel and the cockpit right fuse panel. When overheat condition exists in the area between the engine accessory section and the afterburner section, the nearest detector loop completes the circuit through the detector box to the

overheat flasher unit. The overheat flasher completes the circuit to the fire warning light causing the light to flash on and off. In the event a fire or an overheat condition affects both detector loops, the circuit is completed through the detector box directly to the fire warning light, to cause steady illumination. The test switch is used to independently check each detector circuit. When the test switch is placed in "LOOP 1" or "LOOP 2" position the fire warning light will flash. The fire warning light is a push-to-dim light, and is dimmed by depressing the light. Refer to T. O. 1F-106A-2-10 for complete coverage of this system.

Section XII

ELECTRONIC SYSTEMS

<i>Contents</i>	<i>Page</i>
Electronic Systems	12-1
AWCIS Equipment	12-1

ELECTRONIC SYSTEMS

12-1. GENERAL.

The F-106A and F-106B airplane electronic systems consist basically of the aircraft and weapons control system

(AWCIS). Illustrations are not furnished in this manual section due to the security classification of the equipment.

AWCIS EQUIPMENT

12-2. GENERAL.

The AWCIS is installed in F-106 type airplanes to control the airplane and its weapons system in the performance of its interceptor function. During interception, the AWCIS performs most of the electronic and control

functions of the airplane. Due to the security classification of the AWCIS, descriptive information is not furnished in this manual section. For complete information on this system refer to the following technical orders: T.O. 1F-106A-2-15 and T.O. 1F-106A-2-27.

Section XIII

ARMAMENT SYSTEMS

<i>Contents</i>	<i>Page</i>
General	13-1
Missile Launching System	13-2
Special Weapon Launching System	13-7
Armament Electrical System	13-7
Armament Loading	13-9

GENERAL

13-1. DESCRIPTION.

The armament system of the F-106 interceptor airplane is designed to carry and launch four Falcon missiles (GAR-3/3A and/or GAR-4A) and one MB-1 Special Weapon equipped with a nuclear warhead. All weapons are carried in a single armament bay in the airplane fuselage. For location purposes, the missile bay is divided into forward and aft missile bays. Launching of the air-to-air Falcon missiles in flight is accomplished by mechanical, pneumatic, and electrical systems, with additional ballistic system used to launch the Special Weapon. Detailed information on each of the systems mentioned can be found in T. O. 1F-106A-2-12. See figure 13-1 for a diagram of the armament system.

13-2. The armament selector switch on the armament control panel located on the cockpit left console enables the pilot to select the particular armament to be launched on any one pass. Three attack runs may be made; two with missiles and one with Special Weapon. Selections available to the pilot are "VIS IDENT," "RAD," "ALL," "IR," "SPL WPN," and "SALVO." When "VIS IDENT" (visual identification) is selected, the pilot will be guided to a probable target without any armament action being initiated in order that he may visually identify the target. A "RAD" selection will cause the pair of missiles, in the bay containing radar guided missiles (GAR-3/3A), to be extended and fired. If "IR" is selected, the pair of missiles in the bay containing infra-red ray guided missiles (GAR-4A) will be extended and fired. All Falcon missiles are fired when "ALL," is selected. In this case

the aft missiles will be fired first. Launching of the Special Weapon with nuclear warhead is accomplished by selection of "SPL WPN" on the armament selector switch.

13-3. To aid the pilot in locating, identifying, attacking, and destroying an enemy target, each airplane is equipped with AWCIS (Aircraft and Weapons Control Interceptor System). F-106A airplanes carry type MA-1, and F-106B airplanes carry type AN/ASQ-25. With the aid of ground control stations, these systems are capable of guiding the interceptor on a lead collision course to a point in space where radar contact with the target can be made. Radar contact is made when a target pip appears on the AWCIS flight command indicator. After target contact, target identification is made, and the pilot continues to steer a lead collision course. The desired armament is selected, and at a prescribed distance from the target, the pilot manually locks on to the target with his radar. With radar lock-on, the target is automatically tracked, and the system automatically prepares the selected armament for firing. Maintaining the target pip centered, the pilot holds the trigger switch depressed. At the point of maximum hit probability, the AWCIS automatically fires the selected armament. A small "x" appears on the flight command indicator at fire time. When the small "x" disappears, a pullout is in order. A large "X" is exhibited during MB-1 firing to indicate fire and pullout.

13-4. If a lead collision course is not practical, the pilot may, by actuating the pursuit switch on the armament

control panel, set up the AWCIS for pursuit mode attacks. Pursuit mode attacks may be made with or without radar lock-on. With radar lock-on, the extend and fire signals originate in the AWCIS, with the trigger switch functioning as an interlock in the fire circuit. Without radar lock-on, the trigger switch initiates the extend and fire signals, while the AWCIS furnishes target data. In cases of emergency where armament jettisoning becomes necessary, the pilot may discard all weapons by selecting "SALVO" and holding the trigger switch in the second detent. The Special Weapon will eject and all missiles

will fire, with warheads unarmed. Further information on the AWCIS will be found in T. O. 1F-106A-2-15 and T. O. 1F-106A-2-27.

13-5. An arm-safe switch is provided for arming and disarming the weapons system. The switch must be in the "ARM" position whenever a firing pass is made. If the switch is in the "SAFE" position when an armament selection is made, a practice mode will result. The pilot will receive all the indications of a normal attack, but the armament will not be finally prepared or launched.

MISSILE LAUNCHING SYSTEM

13-6. DESCRIPTION.

The missile launching system consists of the pneumatic and mechanical components that open the missile-bay doors and lower the launcher mechanisms into the airstream below the airplane for armament firing. The two missile-bay doors that provide an aerodynamic closure for the bay are attached to the outboard edges of the bay by a longeron hinge. The doors are of conventional rib and skin construction. Each door is constructed in two longitudinal panels with a connecting hinge, permitting the doors to fold when they are opened. Three pneumatic actuating cylinders actuate each door. See figure 13-3 and 13-4 for an illustration of the missile launching system. See figure 13-2 for an illustration of the missile bay door actuating system.

13-7. The forward missile bay contains one extensible launcher mechanism with two launchers. A GAR-3/3A or GAR-4A Falcon missile is attached to each forward launcher. The aft bay contains two separate extensible launcher mechanisms. Each aft launcher mechanism holds a single launcher to which a Falcon missile is attached. Missiles of the same type are usually carried in each bay section. A pneumatic actuating cylinder is provided for each launcher mechanism. In addition, provisions for carrying and ejecting one MB-1 Special Weapon are made between the two missile displacement mechanisms in the aft bay.

13-8. *Applicable to F-106B airplanes.* The forward and aft missile bays each contain two extensible launcher mechanisms. Each launcher mechanism can carry one Falcon missile. Missiles of the same type are loaded in each bay. Although each launcher has its own actuating cylinder, it cannot be operated independently. Normal armament operation calls for the launchers to operate in pairs. Either the pair in the aft bay or the pair in the forward bay may be selected. An MB-1 Special Weapon may be mounted on a rack provided in the aft missile bay between the two aft missile launchers.

13-9. On all airplanes, power for operating the doors and the launcher mechanisms is provided by the pneumatic system of the airplane. Pneumatic pressure is obtained from two air storage flasks pressurized to 3000 psi. The air flasks are installed in the air conditioning compartment and are charged on the ground before flight. No provision is made for recharging the pneumatic system during flight. A pressure regulator in the pneumatic system of the airplane regulates the 3000 psi air to 1500 psi for the armament system.

13-10. Armament system pressure is applied at all times to a solenoid door selector valve, to the retract side of six door-actuating cylinders and their three pressure-operated selector valves, to the launcher-retract snubbers, and to the retract side of each launcher-actuating cylinder. When the electrical door open signal is applied to the extend solenoid of the solenoid door selector valve, the valve produces an extend "pilot" control pressure. The extend "pilot" pressure is applied to the extend side of the three pressure-operated door-selector valves. Each door-selector valve is positioned to port extend pressure to two of the six door-actuating cylinders. Air at approximately 1500 psi pressure acting on the retract and extend sides of the door-actuating cylinder-rod pistons, causes the doors to open.

13-11. The extend "pilot" pressure applied to the pressure-operated door-selector valves is also applied simultaneously to the launcher solenoid selector valves for the launcher-actuating cylinders. After the doors are opened, an intervalometer-initiated, launcher-down signal is applied to the extend solenoid of either the forward or aft launcher solenoid selector valve (depending on bay selection information applied to the intervalometer). The launcher-down signal causes the launcher solenoid valve to direct this same extend "pilot" to a pressure-controlled valve, an integral part of the actuating cylinder assembly, and to an uplatch mechanism unlatch cylinder. The pressure-controlled valve then connects the extend and retract ports of the launcher cylinder, allowing air from

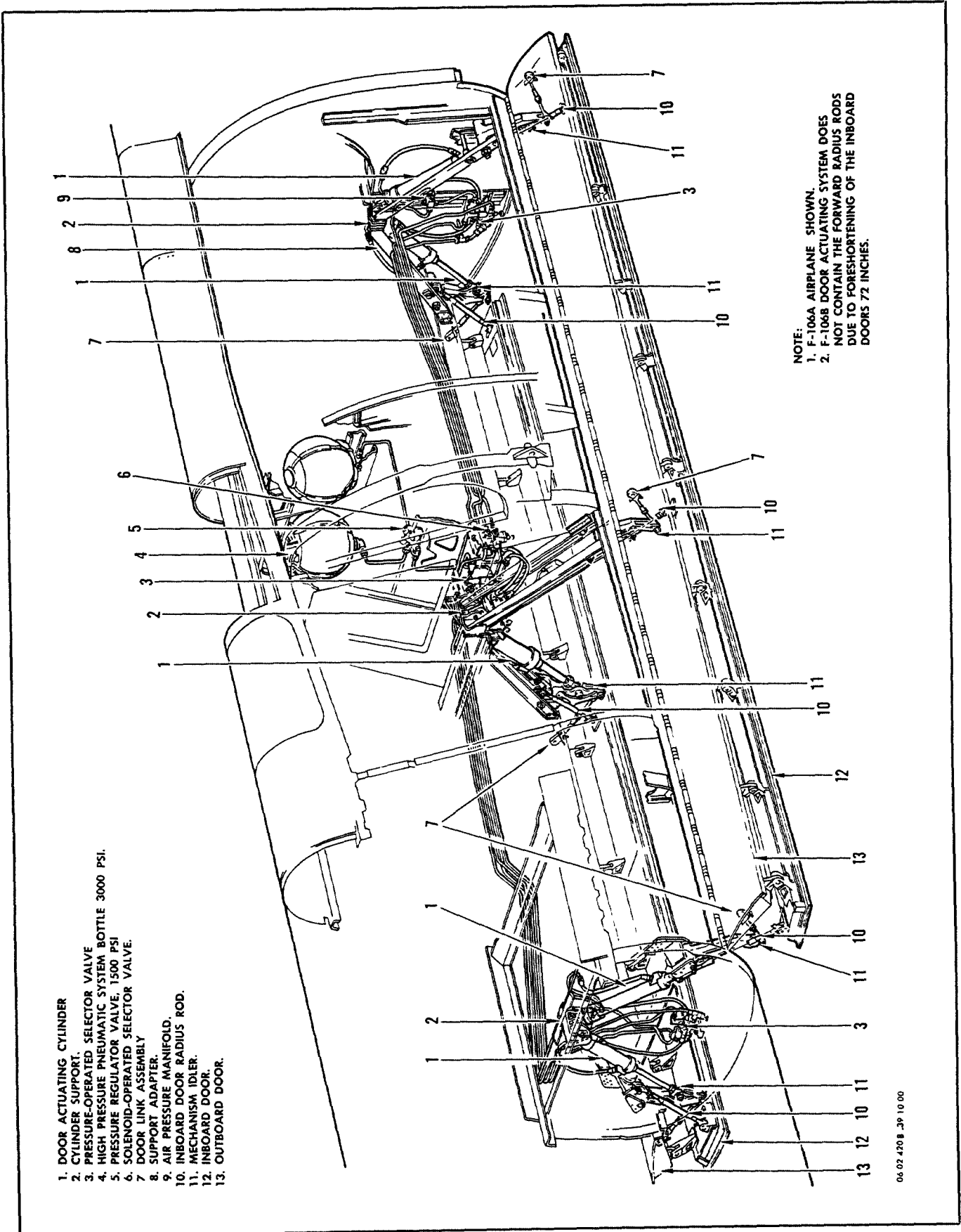

- 1. DOOR ACTUATING CYLINDER
- 2. CYLINDER SUPPORT
- 3. PRESSURE-OPERATED SELECTOR VALVE
- 4. HIGH PRESSURE PNEUMATIC SYSTEM BOTTLE 3000 PSI.
- 5. PRESSURE REGULATOR VALVE, 1500 PSI
- 6. SOLENOID-OPERATED SELECTOR VALVE
- 7. DOOR LINK ASSEMBLY
- 8. SUPPORT ADAPTER
- 9. AIR PRESSURE MANIFOLD
- 10. INBOARD DOOR RADIUS ROD.
- 11. MECHANISM IDLER.
- 12. INBOARD DOOR.
- 13. OUTBOARD DOOR.

NOTE:
 1. F-106A AIRPLANE SHOWN.
 2. F-106B DOOR ACTUATING SYSTEM DOES NOT CONTAIN THE FORWARD RADIUS RODS DUE TO FORESHORTENING OF THE INBOARD DOORS 72 INCHES.

06 02 420 B JP 10 00

Figure 13-2. Missile Bay Door Actuating System

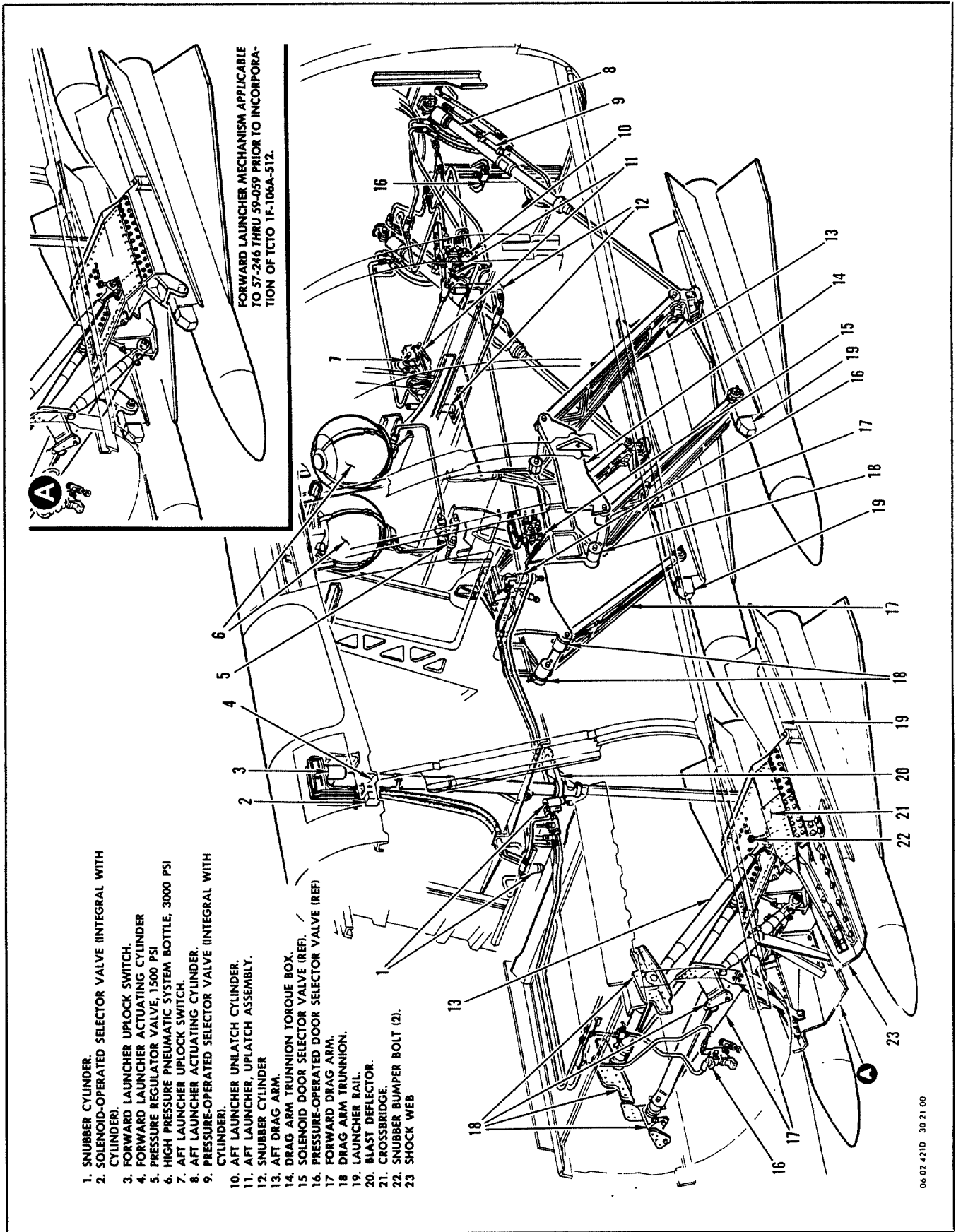

1. SNUBBER CYLINDER.
2. SOLENOID-OPERATED SELECTOR VALVE (INTEGRAL WITH CYLINDER).
3. FORWARD LAUNCHER UNLATCH SWITCH.
4. FORWARD LAUNCHER ACTUATING CYLINDER
5. PRESSURE REGULATOR VALVE, 1500 PSI
6. HIGH PRESSURE PNEUMATIC SYSTEM BOTTLE, 3000 PSI
7. AFT LAUNCHER UNLATCH SWITCH.
8. AFT LAUNCHER ACTUATING CYLINDER.
9. PRESSURE-OPERATED SELECTOR VALVE (INTEGRAL WITH CYLINDER).
10. AFT LAUNCHER UNLATCH CYLINDER.
11. AFT LAUNCHER, UPLATCH ASSEMBLY.
12. SNUBBER CYLINDER
13. AFT DRAG ARM.
14. DRAG ARM TRUNNION TORQUE BOX.
15. SOLENOID DOOR SELECTOR VALVE (REF).
16. PRESSURE-OPERATED DOOR SELECTOR VALVE (REF)
17. FORWARD DRAG ARM.
18. DRAG ARM TRUNNION.
19. LAUNCHER RAIL.
20. BLAST DEFLECTOR.
21. CROSSBRIDGE.
22. SNUBBER BUMPER BOLT (2).
23. SHOCK WEB

FORWARD LAUNCHER MECHANISM APPLICABLE TO 57-246 THRU 59-059 PRIOR TO INCORPORATION OF TCTO 1F-106A-512.

Figure 13-3. Missile Launching System, F-106A

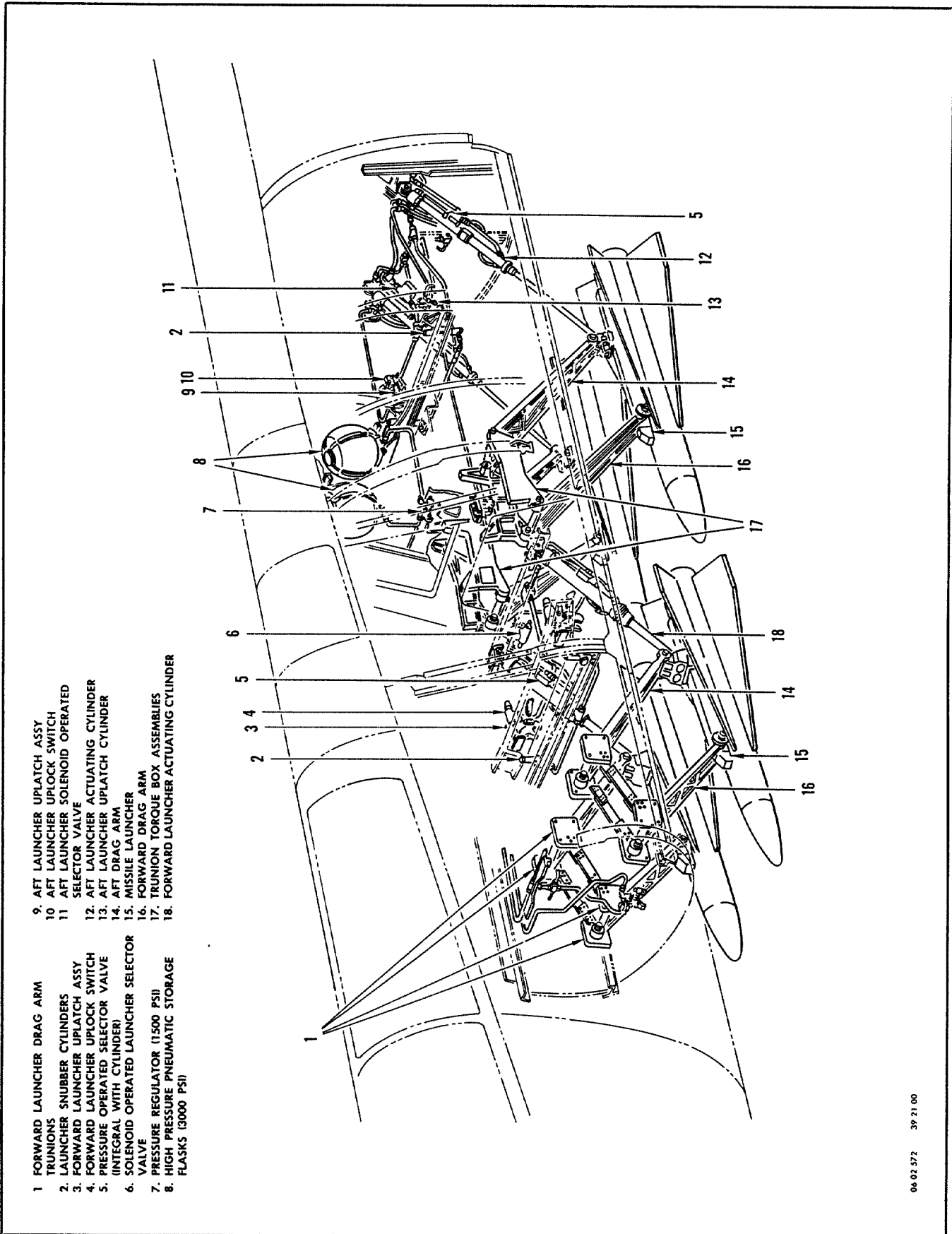

- | | |
|---|--|
| <ul style="list-style-type: none"> 1 FORWARD LAUNCHER DRAG ARM 2 LAUNCHER SNUBBER CYLINDERS 3 FORWARD LAUNCHER UPLATCH ASSY 4 FORWARD LAUNCHER UPLATCH SWITCH 5 PRESSURE OPERATED SELECTOR VALVE (INTEGRAL WITH CYLINDER) 6 SOLENOID OPERATED LAUNCHER SELECTOR VALVE 7 PRESSURE REGULATOR (1500 PSI) 8 HIGH PRESSURE PNEUMATIC STORAGE FLASKS (3000 PSI) | <ul style="list-style-type: none"> 9 AFT LAUNCHER UPLATCH ASSY 10 AFT LAUNCHER UPLATCH SWITCH 11 AFT LAUNCHER SOLENOID OPERATED SELECTOR VALVE 12 AFT LAUNCHER ACTUATING CYLINDER 13 AFT LAUNCHER UPLATCH CYLINDER 14 AFT DRAG ARM 15 MISSILE LAUNCHER 16 FORWARD DRAG ARM 17 TRUNION TORQUE BOX ASSEMBLIES 18 FORWARD LAUNCHER ACTUATING CYLINDER |
|---|--|

Figure 13-4. Missile Launching System, F-106B

the retract side of the cylinder to run around to the extend side. A larger extend piston area produces a greater extend force that lowers the launcher mechanism. The intervalometer sends a fire pulse to the missile motor igniters. If the launchers are extended and necessary electrical interlocks are completed, the selected missiles are fired.

13-12. After the selected missiles have been fired, the intervalometer sends an electrical launcher-up signal to the retract solenoid of the launcher solenoid selector valve. The launcher solenoid valve vents extend "pilot"

pressure from the extend side of the actuating cylinder and applies it to the retract side, causing the launcher to retract.

13-13. With the launchers retracted, the intervalometer door-close signal circuit is completed to the retract solenoid of the solenoid door-selector valve. The solenoid door-selector valve vents extend "pilot" pressure and applies retract "pilot" pressure, to the pressure-operated door-selector valves. The door-selector valves vent the extend side of the door-actuating cylinders. At the retract side of the cylinders, 1500 psi air pressure causes the doors to close.

SPECIAL WEAPON LAUNCHING SYSTEM

13-14. DESCRIPTION.

The MB-1 Special Weapon is carried between the two missile-launcher mechanisms in the aft bay. The special weapon is launched by means of an electrically fired ballistic ejection system. The ejection system is contained in a long detachable rack bolted to the fuselage structure. Ejector units, located at each end of the rack, are connected by ballistic tubing to a breech cylinder assembly mounted at about midpoint on the rack.

13-15. The special weapon is suspended by two shackles at the forward ejector and a single shackle at the aft ejector. Both forward and aft shackles are spring-loaded to the open position and are maintained in the closed position through a blocking device forced between the upper portion of the shackles. The shackles open when the blocking device is pulled away. Tie rods connect the shackle release blocks to a release mechanism at the breech assembly on the ejector assembly. The breech assembly contains a breech piston that actuates the release mechanism. Power for actuating the ejection mechanism is furnished by gases released when five cartridges in the breech assembly are fired. *Applicable to F-106A airplanes 56-453, 56-454, 56-456 thru 57-245, 59-001 and subsequent, and F-106B airplanes 57-2508 thru 57-2515,*

57-2542 and subsequent, a motor actuated release lock pin must be in the unlocked position to release the ejection mechanism for operation. Two MB-1 motor initiators within the weapon must be actuated upon ejection to initiate the motor ignition train. A lanyard assembly, clipped to the ejection rack assembly, performs this function. Action signals are initiated by the Aircraft and Weapons Control Interceptor System when a target is within range. When the "extend" signal is initiated, the missile bay doors start to open and the thermal battery squibs within the weapon are fired. Heat generated by the squibs liquifies the chemicals in the thermal battery causing the battery to become charged. When the "fire" signal is applied, the ejection cartridges in the breech assembly are fired if the trigger switch is held depressed, the launchers are up and locked, and the missile bay doors are fully open. Ballistic pressure is applied to the ejector pistons and to the auxiliary piston at the breech. The auxiliary piston actuates the shackle-release mechanism, and the ejector pistons thrust the MB-1 weapon downward. MB-1 motor initiators are actuated when the weapon reaches the full length of the lanyard upon separation, and the weapon propellant ignites immediately. At 0.75 second after separation, the missile bay doors start to close.

ARMAMENT ELECTRICAL SYSTEM

13-16. DESCRIPTION.

The signals that initiate door and launcher action and armament firing during flight originate in the Aircraft and Weapons Control Interceptor System or in the control stick trigger. During ground operation, door and launcher control is accomplished through the armament

manual control panel in the right main wheel well, or through the remote control box by correction to the armament manual control panel. The general operating sequence of the missile launching system during an interception is controlled by the intervalometer; and if the MB-1 Special Weapon is selected, the sequence is controlled by the armament control relay box.

13-17. After radar target lock-on is made during a lead collision interception or a pursuit mode attack, extend and fire signals will be initiated by the AWCIS when the target is within proper range. Since the trigger switch functions as an interlock with the AWCIS fire circuit, it must be depressed before fire time if the selected armament is to be fired automatically. The trigger switch is placed in the AWCIS circuitry by the trigger transfer relay (armament control relay box) in all selections except "SALVO" and "VIS IDENT." Information supplied by the radar fire control systems aids the pilot in determining the appropriate moment to squeeze the trigger.

13-18. The armament electrical system operates in the following manner: The pilot selects the armament to be fired by means of the armament selector switch. The pilot can select radar missiles, infra-red missiles, or all missiles for firing. He can also select the MB-1 Special Weapon or a salvo operation. In accordance with the selection on the armament selector switch, the AWCIS will present bay-selection information to the intervalometer. The bay-selection information prepares the intervalometer to send a launcher down signal to lower the selected missiles for firing when the missile bay doors are opened. The bay (forward or aft) in which either GAR-3/3A or GAR-4A missiles are loaded, coincides with the bay-selection information originated at the armament selector switch. That is, if radar missiles are carried in the forward bay and "RAD" selection is made, the bay-selection information will cause the intervalometer to produce a "forward launcher down" signal when the doors are opened.

13-19. After making an armament selection, the pilot must next activate the arm-safe switch to the "ARM" position. Circuits in the armament-control relay box and the intervalometer are energized in preparation for the extend signal from the AWCIS. Power is supplied to the AWCIS for signals that initiate door and launcher operation and armament firing.

13-20. The AWCIS initiated extend signal is applied to the intervalometer through the armament control relay box. The intervalometer furnishes the door open signal to the solenoid door-selector valve. The solenoid door-selector valve causes the door-actuating cylinders to extend and open the doors.

13-21. With the doors open, door-open position switches are actuated. The door-open position switches close the launcher-down circuit from the intervalometer to the selected launcher solenoid selector valve. The launcher solenoid selector valve operates to extend the selected missiles for firing. The AWCIS furnishes the fire signal to the intervalometer through the armament control relay box. If the launcher down position switches have been actuated, the missile rocket motors are ignited by the intervalometer.

13-22. At a fixed time after the fire pulse is initiated, the intervalometer simultaneously removes the door-open signal and the launcher-down signal and initiates door-close and launcher-up signals. If both missiles have left the launching mechanism, the launchers will retract. When the launchers reach their up-locked position, up-lock switches are actuated. The actuation of these switches completes the door-close signal circuit to the solenoid door-selector valve. This valve then applies a pneumatic signal to the pressure-operated door-selector valves, causing the doors to close.

13-23. If the AWCIS extend signal is lost at the input to the armament control relay box after the missile bay doors are in motion toward the open position, the doors will continue to the open position. Extension of the launchers in the selected bay will follow. Approximately 2.2 seconds are required for doors to open and launchers in the selected bay to reach the full down position. If the extend signal is lost at the input to the intervalometer, no door or launcher actuation will be initiated. Loss of the extend signal at the intervalometer before initiation of the AWCIS fire signal, but after door opening and launcher extension, will result in launcher retraction and door closure. No hold power is available at this time to maintain the intervalometer extend relays in the actuated position. Initiation of the fire signal occurs approximately 4.0 seconds after the AWCIS extend signal. Loss of the AWCIS extend or bay select signals, after the AWCIS fire signal has started the intervalometer timing cycle, will not affect completion of the armament cycle. The timing cycle begins when the intervalometer clutch fire coil is energized by the AWCIS fire signal.

13-24. When a missile fails to separate from its launcher, after receiving an igniter fire pulse, misfire circuits are energized to prevent door closure and to keep the misfired launcher group extended. The launchers will not be automatically retracted after a misfire, nor will the doors automatically close after a misfire or an aborted pass. In an aborted pass, the "door open" warning light is illuminated when the extend signal is removed. To retract the launchers and close the doors after a misfire or an aborted pass, the pilot must actuate and hold the manual door-close switch until the door-open warning light extinguishes.

13-25. If the AWCIS fire signal is removed before it can initiate the intervalometer timing cycle, no intervalometer output firing pulse is produced. The launchers then remain in the extended position until the fire signal is applied, the bay select signal is removed, or the pilot actuates the door-close switch. If the fire signal is removed after initiating the intervalometer timing cycle, the timing cycle will continue and the operating sequence will be completed.

13-26. The operating sequence, during the launching and firing of missiles in only one bay, has been described. Unless an "ALL" selection is made on the armament

selector switch, the armament of only one bay will be fired during a single pass. With an "ALL" selection, the missiles in the aft bay will be fired first; then the missiles in the forward bay will be fired. If the fire signal is removed after initiating the aft timing cycles, the aft cycle will be completed. If all other signals remain

normal, the forward launchers will be extended, but the forward missiles will not be fired unless the fire signal is re-established. The intervalometer controls the sequence. If an "ALL" selection is made with missiles available in one bay, only the launchers in that bay will be extended and the missiles fired.

ARMAMENT LOADING

13-27. GENERAL.

Information on armament loading is contained in T.O. 1F-106A-16-1. Personnel engaged in the loading of Falcon missiles and MB-1 Special Weapons should be thoroughly instructed in the safety practices required in handling each of these types of armament. In addition, armament loading personnel should be familiar with

the operation of the armament system and be thoroughly aware of the safety precautions that must be observed when working near the missile-bay doors. Special care should be taken to determine that stray voltages are not present at the missile and special weapon umbilical connectors and firing mechanism when making electrical connections to live armament.