

***TM 1-1520-237-10**

TECHNICAL MANUAL

OPERATOR'S MANUAL

FOR

UH-60A HELICOPTER

UH-60L HELICOPTER

EH-60A HELICOPTER

DISTRIBUTION STATEMENT A. Approved for public release; distribution is unlimited.

***This manual supersedes TM 1-1520-237-10, dated 31 August 1994, including all changes.**

HEADQUARTERS, DEPARTMENT OF THE ARMY

31 OCTOBER 1996

Report Documentation Page

Report Date 31OCT1996	Report Type N/A	Dates Covered (from... to) -
Title and Subtitle Operator's Manual for UH-60A Helicopter, UH60L Helicopter, EH-60A Helicopter	Contract Number	
	Grant Number	
	Program Element Number	
Author(s)	Project Number	
	Task Number	
	Work Unit Number	
Performing Organization Name(s) and Address(es) Headquarters, Department of the Army	Performing Organization Report Number	
Sponsoring/Monitoring Agency Name(s) and Address(es)	Sponsor/Monitor's Acronym(s)	
	Sponsor/Monitor's Report Number(s)	
Distribution/Availability Statement Approved for public release, distribution unlimited		
Supplementary Notes This manual supersedes TM 1-1520-237-10, dated 31 August 1994, including all changes., The original document contains color images.		
Abstract		
Subject Terms		
Report Classification unclassified	Classification of this page unclassified	
Classification of Abstract unclassified	Limitation of Abstract UU	
Number of Pages 836		

CHANGE
NO. 9

HEADQUARTERS
DEPARTMENT OF THE ARMY
WASHINGTON, D.C., 19 April 2002

OPERATOR'S MANUAL FOR

UH-60A, UH-60L AND EH-60A HELICOPTERS

DISTRIBUTION STATEMENT A: Approved for public release; distribution is unlimited.

TM 1-1520-237-10, dated 31 October 1996, is changed as follows:

1. Remove and insert pages as indicated below. New or changed text material is indicated by a vertical bar in the margin. An illustration change is indicated by the current change number. Text that flows to the following page is indicated by the current change number.

Remove pages

A through D

i through iv

2-1 and 2-2

2-11 and 2-12

2-25 through 2-28

2-31 and 2-32

2-41 through 2-44

2-57 and 2-58

2-61 and 2-62

2-64.1 and 2-64.2

2-67 and 2-68

2-77 and 2-78

2-81 through 2-86

2-89 and 2-90

2-93 through 2-96

3-8.1 and 3-8.2

3-32.7 and 3-32.8

3-35 and 3-36

3-46.7 through 3-46.12

3-65 and 3-66

4-31 and 4-32

Insert pages

A through D

i through iv

v/(vi Blank)

2-1 and 2-2

2-11 and 2-12

2-25 through 2-28

2-31 and 2-32

2-41 through 2-44

2-57 and 2-58

2-61 and 2-62

2-64.1 and 2-64.2

2-67 and 2-68

2-77 and 2-78

2-81 through 2-86

2-89 and 2-90

2-93 through 2-96

3-8.1 and 3-8.2

3-32.7 and 3-32.8

3-35 and 3-36

3-46.7 through 3-46.12

3-65 and 3-66

4-31 and 4-32

Remove pages	Insert pages
4-41 and 4-42	4-41 and 4-42
4-49 and 4-50	4-49 and 4-50
4-50.1/(4-50.2 Blank)	4-50.1/(4-50.2 Blank)
4-55 and 4-56	4-55 and 4-56
4-67/(4-68 Blank)	4-67/(4-68 Blank)
5-5 through 5-8	5-5 through 5-8
5-11 through 5-14	5-11 through 5-14
5-21 through 5-25/(5-26 Blank)	5-21 through 5-25/(5-26 Blank)
8-3 and 8-4	8-3 and 8-4
8-5 and 8-6	8-5 and 8-6
8-9 and 8-10	8-9 and 8-10
-----	8-10.1/(8.10.2 Blank)
8-13 through 8-16	8-13 through 8-16
9-11 and 9-12	9-11 and 9-12
9-15 and 9-16	9-15 and 9-16

2. Retain this sheet in front of manual for reference purposes.

By Order of the Secretary of the Army:

ERIC K. SHINSEKI
General, United States Army
Chief of Staff

Official:

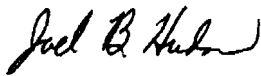

JOEL B. HUDSON
Administrative Asssistant to the
Secretary of the Army

0122803

DISTRIBUTION:

To be distributed in accordance with Initial Distribution Number (IDN) 310284, requirements for TM 1-1520-237-10.

CHANGE
NO. 8

HEADQUARTERS
DEPARTMENT OF THE ARMY
WASHINGTON, D.C., 15 JUNE 2001

**OPERATOR'S MANUAL
FOR
UH-60A HELICOPTERS, UH-60L HELICOPTERS
AND EH-60A HELICOPTERS**

DISTRIBUTION STATEMENT A: Approved for public release; distribution is unlimited.

TM 1-1520-237-10, dated 31 October 1996, is changed as follows:

1. Remove and insert pages as indicated below. New or changed text material is indicated by a vertical bar in the margin. An illustration change is indicated by a vertical bar next to the figure title. Text that flows to the following page is indicated by a current change number.

Remove pages

a and b
A through C/(D Blank)
i through iv
2-1 and 2-2
2-11 and 2-12
2-12.1/(2-12.2 Blank)
2-15 and 2-16
2-25 and 2-26
2-29 and 2-30
2-33 and 2-34
2-34.1/(2-34.2 Blank)
2-35 through 2-40
2-53 and 2-54
2-55 through 2-58
2-85 and 2-86
3-1 through 3-4
3-7 and 3-8
3-8.1 and 3-8.2
3-29 and 3-30

Insert pages

a and b
A through D
i through iv
2-1 and 2-2
2-11 and 2-12
2-12.1/(2-12.2 Blank)
2-15 and 2-16
2-25 and 2-26
2-29 and 2-30
2-33 and 2-34
2-34.1/(2-34.2 Blank)
2-35 through 2-40
2-53 and 2-54
2-55 through 2-58
2-85 and 2-86
3-1 through 3-4
3-7 and 3-8
3-8.1 and 3-8.2
3-29 and 3-30

TM 1-1520-237-10
C8

Remove pages

3-32.1 through 3-32.11/(3-32.12 Blank)
3-35 and 3-36
3-46.3 and 3-46.4
3-46.7 through 3-46.10
3-46.21 and 3-46.22
3-65 and 3-66
3-73 and 3-74
3-77 and 3-78
3-78.1 and 3-78.2
3-79/(3-80 Blank)
4-9 through 4-12
4-25 and 4-26

4-51 through 4-54
5-5 and 5-6
5-19 and 5-20
6-3 through 6-6
7-55 and 7-56
7-125 and 7-126
7-137 and 7-138
7A-139 and 7A-140
7A-143 and 7A-144
8-3 and 8-4
8-4.1/(8-4.2 Blank)
8-5 through 8-8
8-8.1/(8-8.2 Blank)
8-9 through 8-12
8-15 and 8-16
8-17 through 8-22
8-23/(8-24 Blank)
9-1 through 9-6
9-6.1/(9-6.2 Blank)
9-11 through 9-18
9-19 and 9-20
B-1 through B-3/(B-4 Blank)

Insert pages

3-32.1 through 3-32.13/(3-32.14 Blank)
3-35 and 3-36
3-46.3 and 3-46.4
3-46.7 through 3-46.10
3-46.21 and 3-46.22
3-65 and 3-66
3-73 and 3-74
3-77 and 3-78
3-78.1 and 3-78.2
3-79/(3-80 Blank)
4-9 through 4-12
4-25 and 4-26
4-26.1/(4-26.2 Blank)
4-51 through 4-54
5-5 and 5-6
5-19 and 5-20
6-3 through 6-6
7-55 and 7-56
7-125 and 7-126
7-137 and 7-138
7A-139 and 7A-140
7A-143 and 7A-144
8-3 and 8-4
8-4.1/(8-4.2 Blank)
8-5 through 8-8
8-8.1/(8-8.2 Blank)
8-9 through 8-12
8-15 and 8-16
8-17 through 8-22
8-23/(8-24 Blank)
9-1 through 9-6
9-6.1/(9-6.2 Blank)
9-11 through 9-18
9-19 and 9-20
B-1 through B-3/(B-4 Blank)
C-1 through C-3/(C-4 Blank)

By Order of the Secretary of the Army:

Official:

ERIC K. SHINSEKI
General, United States Army
Chief of Staff

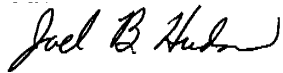

JOEL B. HUDSON
Administrative Assistant to the
Secretary of the Army
0103660

DISTRIBUTION:

To be distributed in accordance with initial distribution number (IDN) 310284 requirements for TM 1-1520-237-10.

CHANGE
NO. 7

HEADQUARTERS
DEPARTMENT OF THE ARMY
WASHINGTON, D.C., 27 NOVEMBER 2000

**OPERATOR'S MANUAL
FOR**

**UH-60A HELICOPTERS, UH-60L HELICOPTERS
AND EH-60A HELICOPTERS**

DISTRIBUTION STATEMENT A: Approved for public release; distribution is unlimited.

TM 1-1520-237-10, dated 31 October 1996, is changed as follows:

1. Remove and insert pages as indicated below. New or changed text material is indicated by a vertical bar in the margin. An illustration change is indicated by the current change number. Text that flows to the following page is indicated by the current change number.

Remove pages

A through C/(D Blank)

2-1 and 2-2

2-21 and 2-22

2-47 and 2-48

2-87 and 2-88

2-93 and 2-94

4-5 and 4-6

4-9 through 4-12

4-43 and 4-44

4-47 and 4-48

4-48.1/(4-48.2 Blank)

4-51 through 4-54

4-60.5 and 4-60.6

4-65 and 4-66

7A-15 and 7A-16

9-1 and 9-2

Insert pages

A through C/(D Blank)

2-1 and 2-2

2-21 and 2-22

2-47 and 2-48

2-87 and 2-88

2-93 and 2-94

4-5 and 4-6

4-9 through 4-12

4-43 and 4-44

4-47 and 4-48

4-48.1/(4-48.2 Blank)

4-51 through 4-54

4-60.5 and 4-60.6

4-65 and 4-66

7A-15 and 7A-16

9-1 and 9-2

Remove pages

9-6.1/(9-6.2 Blank)
9-19 through 9-22
B-1 and B-2

Insert pages

9-6.1/(9-6.2 Blank)
9-19 through 9-22
B-1 and B-2

2. Retain this sheet in front of manual for reference purposes.

By Order of the Secretary of the Army:

Official:

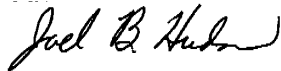

JOEL B. HUDSON
*Administrative Assistant to the
Secretary of the Army*
0019571

ERIC K. SHINSEKI
*General, United States Army
Chief of Staff*

DISTRIBUTION:

To be distributed in accordance with Initial Distribution Number (IDN) 310284 requirements for TM 1-1520-237-10.

CHANGE
NO. 6

HEADQUARTERS
DEPARTMENT OF THE ARMY
WASHINGTON, D.C., 3 APRIL 2000

**OPERATOR'S MANUAL
FOR**

**UH-60A HELICOPTERS, UH-60L HELICOPTERS
AND EH-60A HELICOPTERS**

DISTRIBUTION STATEMENT A: Approved for public release; distribution is unlimited.

TM 1-1520-237-10, dated 31 October 1996, is changed as follows:

1. Remove and insert pages as indicated below. New or changed text material is indicated by a vertical bar in the margin. An illustration change is indicated by the current change number. Text that flows to the following page is indicated by the current change number.

Remove pages

A through C/(D Blank)

1-1 and 1-2

2-11 and 2-12

2-12.1/(2-12.2 Blank)

2-33 and 2-34

2-34.1/(2-34.2 Blank)

2-47 and 2-48

2-51 through 2-54

2-77 and 2-78

2-89 and 2-90

4-9 through 4-12

4-41 and 4-42

4-53 and 4-54

4-67/(4-68 Blank)

5-1 and 5-2

Insert pages

A through C/(D Blank)

1-1 and 1-2

2-11 and 2-12

2-12.1/(2-12.2 Blank)

2-33 and 2-34

2-34.1/(2-34.2 Blank)

2-47 and 2-48

2-51 through 2-54

2-77 and 2-78

2-89 and 2-90

4-9 through 4-12

4-41 and 4-42

4-42.1/(4-42.2 Blank)

4-53 and 4-54

4-67/(4-68 Blank)

5-1 and 5-2

TM 1-1520-237-10

C 6

Remove pages

5-9 and 5-10

5-23 and 5-24

6-1 and 6-2

7-1 and 7-2

7A-5 and 7A-6

7A-7 through 7A-12

7A-15 and 7A-16

8-7 and 8-8

8-11 and 8-12

9-19 through 9-22

A-1 and A-2

Insert pages

5-9 and 5-10

5-23 and 5-24

6-1 and 6-2

7-1 and 7-2

7-2.1/(7-2.2 Blank)

7A-5 and 7A-6

7A-6.1/(7A-6.2 Blank)

7A-7 through 7A-12

7A-12.1/(7A-12.2 Blank)

7A-15 and 7A-16

8-7 and 8-8

8-8.1/(8-8.2 Blank)

8-11 and 8-12

9-19 through 9-22

A-1 and A-2

2. Retain these sheets in front of the manual for reference purposes.

By Order of the Secretary of the Army:

ERIC K. SHINSEKI
General, United States Army
Chief of Staff

OFFICIAL:

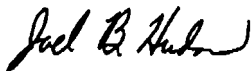

JOEL B. HUDSON
Administrative Assistant to the
Secretary of the Army
9931322

DISTRIBUTION:

To be distributed in accordance with Initial Distribution Number (IDN) 310284, requirements for TM 1-1520-237-10.

CHANGE
NO. 5

HEADQUARTERS
DEPARTMENT OF THE ARMY
WASHINGTON, D.C., 30 JULY 1999

OPERATOR'S MANUAL
FOR
UH-60A HELICOPTERS, UH-60L HELICOPTERS
AND EH-60A HELICOPTERS

DISTRIBUTION STATEMENT A: Approved for public release; distribution is unlimited.

TM 1-1520-237-10, dated 31 October 1996, is changed as follows:

1. Remove and insert pages as indicated below. New or changed text material is indicated by a vertical bar in the margin. An illustration change is indicated by the current change number. Text that flows to the following page is indicated by the current change number.

Remove pages

None
2-11 and 2-12
2-25 and 2-26
2-35 and 2-36
2-45 and 2-46
2-51 through 2-54
2-54.1/(2-54.2 blank)
2-55 and 2-56
2-73 and 2-74
2-77 through 2-80
2-83 and 2-84
2-89 through 2-92
2-95 and 2-96
3-5 through 3-8
3-8.1/(3-8.2 blank)
3-15 and 3-16

Insert pages

A through C/(D blank)
2-11 and 2-12
2-25 and 2-26
2-35 and 2-36
2-45 and 2-46
2-51 through 2-54
2-54.1/(2-54.2 blank)
2-55 and 2-56
2-73 and 2-74
2-77 through 2-80
2-83 and 2-84
2-89 through 2-92
2-95 and 2-96
3-5 through 3-8
3-8.1/(3-8.2 blank)
3-15 and 3-16

TM 1-1520-237-10
C 5

Remove pages	Insert pages
3-53 and 3-54	3-53 and 3-54
None	3-54.1/(3-54.2 blank)
3-69 through 3-72	3-69 through 3-72
None	3-72.1/(3-72.2 blank)
3-75 and 3-76	3-75 and 3-76
4-11 and 4-12	4-11 and 4-12
4-48.1/(4-48.2 blank)	4-48.1/(4-48.2 blank)
4-49 and 4-50	4-49 and 4-50
None	4-50.1/(4-50.2 blank)
5-19 and 5-20	5-19 and 5-20
6-23 and 6-24	6-23 and 6-24
7A-3 and 7A-4	7A-3 and 7A-4
8-3 and 8-4	8-3 and 8-4
8-5 through 8-10	8-5 through 8-10
8-13 through 8-16	8-13 through 8-16
8-17 through 8-20	8-17 through 8-20
9-17 and 9-18	9-17 and 9-18
9-19 through 9-22	9-19 through 9-22
Index-3 through Index-8	Index-3 through Index-8
None	Index-8.1/(Index-8.2 blank)
Index-13 and Index-14	Index-13 and Index-14
None	Index-14.1/(Index-14.2 blank)
Index-19 through Index-22	Index-19 through Index-22
None	Index-22.1/(Index-22.2 blank)

2. Retain these sheets in front of the manual for reference purposes.

By Order of the Secretary of the Army:

ERIC K. SHINSEKI
General, United States Army
Chief of Staff

OFFICIAL:

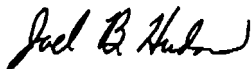

JOEL B. HUDSON
Administrative Assistant to the
Secretary of the Army
9917308

DISTRIBUTION:

To be distributed in accordance with Initial Distribution Number (IDN) 313721, requirements for TM 1-1520-237-10.

CHANGE
NO. 4

HEADQUARTERS
DEPARTMENT OF THE ARMY
WASHINGTON, D.C., 29 JANUARY 1999

OPERATOR'S MANUAL
FOR
UH-60A HELICOPTERS, UH-60L HELICOPTERS, AND EH-60A HELICOPTERS

DISTRIBUTION STATEMENT A: Approved for public release; distribution is unlimited.

TM 1-1520-237-10, dated 31 October 1996, is changed as follows:

1. Remove and insert pages as indicated below. New or changed text material is indicated by a vertical bar in the margin. An illustration change is indicated by a vertical bar next to the figure title. Text that flows to the following page is indicated by the current change number

Remove pages	Insert pages
a/(b blank)	a and b
1-1 and 1-2	1-1 and 1-2
2-1 and 2-2	2-1 and 2-2
2-7 and 2-8	2-7 and 2-8
2-11 and 2-12	2-11 and 2-12
2-12.1/(2-12.2 blank)	2-12.1/(2-12.2 blank)
2-17 through 2-20	2-17 through 2-20
2-63 and 2-64	2-63 and 2-64
3-3 through 3-8	3-3 through 3-8
3-29 through 3-32	3-29 through 3-32
None	3-32.1 through 3-32.11/(3-32.12 blank)
3-35 and 3-36	3-35 and 3-36
3-45 and 3-46	3-45 and 3-46
3-46.3 and 3-46.4	3-46.3 and 3-46.4
3-46.7 through 3-46.12	3-46.7 through 3-46.12
3-46.15 through 3-46.20	3-46.15 through 3-46.20
3-65 and 3-66	3-65 and 3-66
3-69 and 3-70	3-69 and 3-70
3-78.1 and 3-78.2	3-78.1 and 3-78.2
4-11 and 4-12	4-11 and 4-12
None	4-12.1/(4-12.2 blank)

TM 1-1520-237-10

C 4

Remove pages
4-15 and 4-16

4-19 and 4-20
4-51 through 4-54
4-57 through 4-60
None
5-23 and 5-24
None
8-7 through 8-16
None
8-23/(8-24 blank)
9-23 and 9-24
None
A-1 and A-2
B-1 through B-3/B-4 blank)

Insert pages
4-15 and 4-16

4-19 and 4-20
4-51 through 4-54
4-57 through 4-60
4-60.1 through 4-60.6
5-23 and 5-24
5-25/(5-26 blank)
8-7 through 8-16
8-16.1/(8-16.2 blank)
8-23/(8-24 blank)
9-23 and 9-24
9-25/(9-26 blank)
A-1 and A-2
B-1 through B-3/(B-4 blank)

2. Retain these sheets in front of the manual for reference purposes.

By Order of the Secretary of the Army:

DENNIS J. REIMER
General, United States Army
Chief of Staff

OFFICIAL:

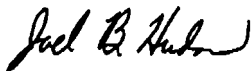

JOEL B. HUDSON
Administrative Assistant to the
Secretary of the Army
05406

DISTRIBUTION:

To be distributed in accordance with Initial Distribution Number (IDN) 310284, requirements for TM 1-1520-237-10.

CHANGE
NO. 3

HEADQUARTERS
DEPARTMENT OF THE ARMY
WASHINGTON, D.C., 30 OCTOBER 1998

OPERATOR'S MANUAL
FOR
UH-60A HELICOPTERS, UH-60L HELICOPTERS, AND EH-60A HELICOPTERS

DISTRIBUTION STATEMENT A: Approved for public release; distribution is unlimited.

TM 1-1520-237-10, dated 31 October 1996, is changed as follows:

1. Remove and insert pages as indicated below. New or changed text material is indicated by a vertical bar in the margin. An illustration change is indicated by a vertical bar next to the figure title. Text that flows to the following page is indicated by the current change number

Remove pages	Insert pages
a/(b blank)	a and b
i and ii	i and ii
2-33 and 2-34	2-33 and 2-34
None	2-34.1/(2-34.2 blank)
2-43 and 2-44	2-43 and 2-44
2-47 and 2-48	2-47 and 2-48
2-63 and 2-64	2-63 and 2-64
2-69 and 2-70	2-69 and 2-70
2-73 through 2-76	2-73 through 2-76
2-91 and 2-92	2-91 and 2-92
4-53 through 4-56	4-53 through 4-56
4-65 and 4-66	4-65 and 4-66
5-1 and 5-2	5-1 and 5-2
5-5 through 5-8	5-5 through 5-8
5-23 and 5-24	5-23 and 5-24
None	5-25/(5-26 blank)
6-15 and 6-16	6-15 and 6-16
7-3 through 7-6	7-3 through 7-6
8-3 and 8-4	8-3 and 8-4
None	8-4.1/(8-4.2 blank)
8-5 through 8-16	8-5 through 8-16
8-19 through 8-22	8-19 through 8-22

TM 1-1520-237-10
C 3

Remove pages
8-23/(8-24 blank)
9-6.1/(9-6.2 blank)
9-11 and 9-12
9-15 through 9-18
None
9-19 through 9-24
A-1 and A-2
B-1 and B-2
B-3/(B-4 blank)

Insert pages
8-23/(8-24 blank)
9-6.1/(9-6.2 blank)
9-11 and 9-12
9-15 through 9-18
9-18.1/(9-18.2 blank)
9-19 through 9-24
A-1 and A-2
B-1 and B-2
B-3/(B-4 blank)

2. Retain these sheets in front of the manual for reference purposes.

By Order of the Secretary of the Army:

DENNIS J. REIMER
General, United States Army
Chief of Staff

OFFICIAL:

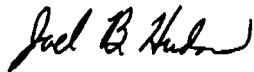

JOEL B. HUDSON
Administrative Assistant to the
Secretary of the Army
05178

DISTRIBUTION:

To be distributed in accordance with Initial Distribution Number (IDN) 310284, requirements for TM 1-1520-237-10.

CHANGE
NO. 2

HEADQUARTERS
DEPARTMENT OF THE ARMY
WASHINGTON, D.C., 29 MAY 1998

OPERATOR'S MANUAL
FOR
UH-60A HELICOPTERS, UH-60L HELICOPTERS, AND EH-60A HELICOPTERS

DISTRIBUTION STATEMENT A: Approved for public release; distribution is unlimited.

TM 1-1520-237-10, dated 31 October 1996, is changed as follows:

1. Remove and insert pages as indicated below. New or changed text material is indicated by a vertical bar in the margin. An illustration change is indicated by a vertical bar next to the figure title. Text that flows to the following page is indicated by the current change number

Remove pages	Insert pages
1-1 and 1-2	1-1 and 1-2
2-11 and 2-12	2-11 and 2-12
None	2-12.1/(2-12.2 blank)
2-15 and 2-16	2-15 and 2-16
2-53 and 2-54	2-53 and 2-54
None	2-54.1/(2-54.2 blank)
2-57 and 2-58	2-57 and 2-58
2-63 and 2-64	2-63 and 2-64
2-65 through 2-70	2-65 through 2-70
2-75 through 2-78	2-75 through 2-78
2-95 and 2-96	2-95 and 2-96
3-45 and 3-46	3-45 and 3-46
3-46.1 through 3-46.21/(3-46.22 blank)	3-46.1 through 3-46.22
5-1 and 5-2	5-1 and 5-2
6-1 and 6-2	6-1 and 6-2
7-11 and 7-12	7-11 and 7-12
7-147 through 7-150	7-147 through 7-150
7A-1 and 7A-2	7A-1 and 7A-2
7A-15 and 7A-16	7A-15 and 7A-16
9-1 through 9-4	9-1 through 9-4
9-13 and 9-14	9-13 and 9-14

TM 1-1520-237-10
C 2

2. Retain these sheets in front of the manual for reference purposes.

By Order of the Secretary of the Army:

DENNIS J. REIMER
General, United States Army
Chief of Staff

OFFICIAL:

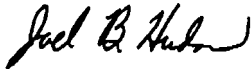

JOEL B. HUDSON
Administrative Assistant to the
Secretary of the Army
04944

DISTRIBUTION:

To be distributed in accordance with Initial Distribution Number (IDN) 310284,
requirements for TM 1-1520-237-10.

CHANGE
NO. 1

HEADQUARTERS
DEPARTMENT OF THE ARMY
WASHINGTON, D.C., 30 JUNE 1997

OPERATOR'S MANUAL
FOR
UH-60A HELICOPTERS, UH-60L HELICOPTERS, AND EH-60A HELICOPTERS

DISTRIBUTION STATEMENT A: Approved for public release; distribution is unlimited.

TM 1-1520-237-10, dated 31 October 1996, is changed as follows:

1. Remove and insert pages as indicated below. New or changed text material is indicated by a vertical bar in the margin. An illustration change is indicated by a vertical bar next to the figure title. Text that flows to the following page is indicated by the current change number

Remove pages	Insert pages
1-1 and 1-2	1-1 and 1-2
2-15 and 2-16	2-15 and 2-16
None	2-16.1/(2-16.2 blank)
2-17 through 2-20	2-17 through 2-20
2-51 through 2-54	2-51 through 2-54
2-63 through 2-66	2-63 through 2-66
2-69 and 2-70	2-69 and 2-70
2-73 through 2-80	2-73 through 2-80
2-83 through 2-86	2-83 through 2-86
2-95 and 2-96	2-95 and 2-96
3-1 through 3-8	3-1 through 3-8
None	3-8.1/(3-8.2 blank)
3-19 and 3-20	3-19 and 3-20
3-29 and 3-30	3-29 and 3-30
3-33 through 3-38	3-33 through 3-38
3-43 through 3-46	3-43 through 3-46
None	3-46.1 through 3-46.21/(3-46.22 blank)
3-53 and 3-54	3-53 and 3-54
3-65 through 3-68	3-65 through 3-68
3-69 through 3-78	3-69 through 78
None	3-78.1/(3-78.2 blank)
4-19 and 4-20	4-19 and 4-20
4-23 and 4-24	4-23 and 4-24
4-33 and 4-34	4-33 and 4-34

TM 1-1520-237-10
C 1

Remove pages

4-39 and 4-40
4-47 and 4-48
None
5-11 through 5-14
9-3 through 9-6
None
9-17 and 9-18
9-23 and 9-24
A-1 and A-2
B-1 and B-2
Index-1 through Index-27/(Index-28 blank)

Insert pages

4-39 and 4-40
4-47 and 4-48
4-48.1/(4-48.2 blank)
5-11 through 5-14
9-3 through 9-6
9-6.1/(9-6.2 blank)
9-17 and 9-18
9-23 and 9-24
A-1 and A-2
B-1 through B-3/(B-4 blank)
Index-1 through Index-27/(Index-28 blank)

2. Retain these sheets in front of the manual for reference purposes.

By Order of the Secretary of the Army:

DENNIS J. REIMER
General, United States Army
Chief of Staff

OFFICIAL:

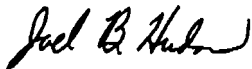

JOEL B. HUDSON
Administrative Assistant to the
Secretary of the Army
03940

DISTRIBUTION:

To be distributed in accordance with DA Form 12-31 E, block no. 0284, requirements for TM 1-1520-237-10.

WARNING

Personnel performing operations, procedures, and practices which are included or implied in this technical manual shall observe the following warnings. Disregard of these warnings and precautionary information can cause serious injury or loss of life.

BATTERY ELECTROLYTE

Battery electrolyte is harmful to the skin and clothing. If potassium hydroxide is spilled on clothing or other material, wash immediately with clean water. If spilled on personnel, immediately flush the affected area with clean water. Continue washing until medical assistance arrives. Neutralize any spilled electrolyte by thoroughly flushing contacted area with water.

CARBON MONOXIDE

When smoke, suspected carbon monoxide fumes, or symptoms of anoxia exist, the crew should immediately ventilate the cockpit.

ELECTROMAGNETIC INTERFERENCE (EMI)

No electrical/electronic devices of any sort, other than those described in this manual or appropriate airworthiness release and approved by USAATCOM AMSAT-R-ECU, are to be operated by crewmembers or passengers during operation of this helicopter.

FIRE EXTINGUISHER

Exposure to high concentrations of extinguishing agent or decomposition products should be avoided. The liquid should not be allowed to come into contact with the skin, as it may cause frost bite or low temperature burns.

HANDLING FUEL AND OIL

Turbine fuels and lubricating oils contain additives which are poisonous and readily absorbed through the skin. Do not allow them to remain on skin longer than necessary.

HIGH VOLTAGE

All ground handling personnel shall be informed of high voltage hazards when making external cargo hookups.

NOISE

Sound pressure levels in this helicopter during some operating conditions exceed the Surgeon General's hearing conservation criteria, as defined in DA PAM 40-501. Hearing protection devices, such as the aviator helmet or ear plugs are required to be worn by all personnel in and around the helicopter during its operation. When window guns are firing, when flights exceed 100 minutes during any 24 hour period, or when speeds are above 120 knots, helmet and ear plugs shall be worn by all crewmembers.

WEAPONS AND AMMUNITION

Observe all standard safety precautions governing the handling of weapons and live ammunition. When not in use, point all weapons in a direction offering the least exposure to personnel and property in case of accidental firing. Do not walk in front of weapons. SAFE the machinegun before servicing. To avoid potentially dangerous situations, follow all procedural warnings in text.

ELECTROMAGNETIC RADIATION

Do not stand within six feet of Aircraft Survivability Equipment (ASE), ALQ-156, ALQ-162, and ALQ-144 transmit antennas when the ASE equipment is on. High frequency electromagnetic radiation can cause internal burns without causing any sensation of heat. The HF radio transmits high power electromagnetic radiation. Serious injury or death can occur if you

touch the HF antenna while it is transmitting. Do not grasp, or lean against the antenna when power is applied to the helicopter.

ALQ-144

Do not continuously look at the ALQ-144 infrared countermeasure transmitter during operation, or for a period of over 1 minute from a distance of less than 3 feet. Skin exposure to countermeasure radiation for longer than 10 seconds at a distance less than 4 inches shall be avoided.

LIST OF EFFECTIVE PAGES

Insert latest change pages; dispose of superseded pages in accordance with applicable policies.

NOTE: On a changed page, the portion of the text affected by the latest change is indicated by a vertical line in the outer margin of the page. Changes to illustrations are indicated by a vertical line in the outer margin of the page next to the illustration title.

Dates of issue for original and change pages are:

Original	31 October 1996
Change 1	30 June 1997
Change 2	29 May 1998
Change 3	30 October 1998
Change 4	29 January 1999
Change 5	30 July 1999
Change 6	28 January 2000
Change 7	27 November 2000
Change 8	15 June 2001
Change 9	19 April 2002

TOTAL NUMBER OF PAGES IN THIS MANUAL IS 804 CONSISTING OF THE FOLLOWING:

Page No.	*Change No.	Page No.	*Change No.	Page No.	*Change No.
Title.....	0	2-16.2 Blank	1	2-41	0
Blank.....	0	2-17	0	2-42	9
a - b.....	8	2-18 - 2-19.....	4	2-43	0
A - D	9	2-20 - 2-21	0	2-44	9
i - v.....	9	2-22	7	2-45 - 2-46.....	5
vi Blank	8	2-23 - 2-24.....	0	2-47	3
1-1	6	2-25	9	2-48	7
1-2	4	2-26	8	2-49 - 2-51	0
2-1	9	2-27	9	2-52	6
2-2	8	2-28 - 2-29.....	0	2-53	5
2-3 - 2-6.....	0	2-30	8	2-54	8
2-7 - 2-8.....	4	2-31	9	2-54.1	2
2-9 - 2-10.....	0	2-32	0	2-54.2 Blank	2
2-11 - 2-12.....	9	2-33 - 2-34.1	8	2-55	8
2-12.1	8	2-34.2 Blank	8	2-56	0
2-12.2 Blank	8	2-35	0	2-57	9
2-13 - 2-14.....	0	2-36	8	2-58	8
2-15 - 2-16.....	8	2-37	0	2-59 - 2-60.....	0
2-16.1	1	2-38 - 2-40.....	8	2-61	9

* Zero in this column indicates an original page.

LIST OF EFFECTIVE PAGES (Cont)

Page No.	*Change No.	Page No.	*Change No.	Page No.	*Change No.
2-62	0	3-8.2	5	3-66	9
2-63	3	3-9 - 3-14	0	3-67 - 3-68	1
2-64	4	3-15	5	3-69	0
2-64.1	2	3-16 - 3-18	0	3-70 - 3-72.1	5
2-64.2	9	3-19	1	3-72.2 Blank	5
2-65	2	3-20 - 3-28	0	3-73	8
2-66	1	3-29 - 3-30	8	3-74	1
2-67	0	3-31 - 3-32	4	3-75	5
2-68	9	3-32.1 - 3-32.2	8	3-76 - 3-77	1
2-69	1	3-32.3	4	3-78 - 3-79	8
2-70	3	3-32.4 - 3-32.7	8	3-80 Blank	0
2-71 - 2-73	0	3-32.8	9	4-1 - 4-5	0
2-74	5	3-32.9 - 3-32.13	8	4-6	7
2-75 - 2-76	3	3-32.14 Blank	8	4-7 - 4-9	0
2-77	9	3-33 - 3-34	1	4-10 - 4-11	8
2-78	6	3-35 - 3-36	9	4-12	7
2-79	5	3-37	1	4-12.1	4
2-80	1	3-38 - 3-42	0	4-12.2 Blank	4
2-81	0	3-43	1	4-13 - 4-14	0
2-82 - 2-85	9	3-44 - 3-45	0	4-15	4
2-86	8	3-46	4	4-16 - 4-19	0
2-87	7	3-46.1 - 3-46.2	2	4-20	4
2-88	0	3-46.3	8	4-21 - 4-22	0
2-89	5	3-46.4	4	4-23	1
2-90	9	3-46.5 - 3-46.6	2	4-24 - 4-25	0
2-91	5	3-46.7	8	4-26 - 4-26.1	8
2-92	3	3-46.8 - 3-46.11	9	4-26.2 Blank	8
2-93	9	3-46.12 - 3-46.15	2	4-27 - 4-30	0
2-94	7	3-46.16	4	4-31	9
2-95	9	3-46.17	2	4-32 - 4-33	0
2-96	1	3-46.18	4	4-34	1
2-97	0	3-46.19	2	4-35 - 4-38	0
2-98 Blank	0	3-46.20	4	4-39	1
3-1	1	3-46.21 - 3-46.22	8	4-40 - 4-41	0
3-2 - 3-3	8	3-47 - 3-52	0	4-42	9
3-4 - 3-5	4	3-53 - 3-54.1	5	4-42.1	6
3-6 - 3-7	5	3-54.2 Blank	5	4-42.2 Blank	6
3-8	8	3-55 - 3-64	0	4-43	0
3-8.1	9	3-65	1	4-44	7

* Zero in this column indicates an original page.

LIST OF EFFECTIVE PAGES (Cont)

Page No.	*Change No.	Page No.	*Change No.	Page No.	*Change No.
4-45 - 4-47	0	6-5	8	7A-145 - 7A-153..	0
4-48 - 4-48.1	7	6-6 - 6-15.....	0	7A-154 Blank.....	0
4-48.2 Blank	7	6-16	3	8-1 - 8-3.....	0
4-49	5	6-17 - 6-23.....	0	8-4	9
4-50 - 4-50.1	9	6-24	5	8-4.1	8
4-50.2 Blank	5	6-25 - 6-29.....	0	8-4.2 Blank	8
4-51	7	6-30 Blank	0	8-5 - 8-6.....	9
4-52	8	7-1 - 7-2.1	6	8-7 - 8-8.1	8
4-53	6	7-2.2 Blank	6	8-8.2 Blank	8
4-54	8	7-3	3	8-9 - 8-10.1	9
4-55	3	7-4	0	8-10.2 Blank	9
4-56	9	7-5	3	8-11 - 8-12.....	8
4-57 - 4-60.4.....	4	7-6 - 7-10.....	0	8-13	9
4-60.5 - 4-60.6.....	7	7-11 - 7-12.....	2	8-14	4
4-61 - 4-64.....	0	7-13 - 7-55.....	0	8-15	9
4-65	3	7-56	8	8-16	8
4-66	7	7-57 - 7-125.....	0	8-16.1	4
4-67	9	7-126	8	8-16.2 Blank	4
4-68 Blank	6	7-127 - 7-136.....	0	8-17	0
5-1	6	7-137	8	8-18 - 8-19.....	8
5-2	3	7-138 - 7-147.....	0	8-20	3
5-3 - 5-5.....	0	7-148 - 7-149.....	2	8-21	8
5-6	9	7-150 - 7-151.....	0	8-22	3
5-7	0	7-152 Blank	0	8-23	8
5-8	9	7A-1	0	8-24 Blank	8
5-9	6	7A-2.....	2	9-1 - 9-3.....	8
5-10 - 5-11	0	7A-3.....	5	9-4	2
5-12 - 5-13.....	9	7A-4 - 7A-5.....	0	9-5	8
5-14 - 5-18.....	0	7A-6 - 7A-6.1	6	9-6	1
5-19	8	7A-6.2 Blank.....	6	9-6.1	8
5-20	0	7A-7	0	9-6.2 Blank	8
5-21	9	7A-8 - 7A-12.1	6	9-7 - 9-10.....	0
5-22	0	7A-12.2 Blank.....	6	9-11	8
5-23 - 5-25.....	9	7A-13 - 7A-14.....	0	9-12	9
5-26 Blank	4	7A-15 - 7A-16.....	7	9-13	8
6-1	6	7A-17 - 7A-138....	0	9-14	2
6-2	0	7A-139.....	8	9-15	0
6-3	8	7A-140 - 7A-143..	0	9-16	9
6-4	0	7A-144.....	8	9-17 - 9-18.....	8

* Zero in this column indicates an original page.

LIST OF EFFECTIVE PAGES (Cont)

Page No.	*Change No.	Page No.	*Change No.	Page No.	*Change No.
9-18.1	3	B-2 - B-3	8	Index-14.2 Blank ...	5
9-18.2 Blank	3	B-4 Blank	8	Index-15 -	
9-19	7	C-1 - C-3	8	Index-18.....	1
9-20	8	C-4 Blank.....	8	Index-19.....	5
9-21	6	Index-1 - Index-3...	1	Index-20 -	
9-22	7	Index-4 - Index-		Index-21.....	1
9-23 - 9-25.....	4	8.1.....	5	Index-22 -	
9-26 Blank	4	Index-8.2 Blank	5	Index-22.1.....	5
A-1	6	Index-9 - Index-12.	1	Index-22.2 Blank ...	5
A-2.....	1	Index-13 -		Index-23 -	
B-1.....	7	Index-14.1.....	5	Index-28.....	1

* Zero in this column indicates an original page.

D Change 9

TECHNICAL MANUAL

NO. 1-1520-237-10

HEADQUARTERS
DEPARTMENT OF THE ARMY
WASHINGTON, D.C. 31 OCTOBER 1996

**Operator's Manual
for
UH-60A, UH-60L, EH-60A HELICOPTERS**

REPORTING ERRORS AND RECOMMENDING IMPROVEMENTS

You can help improve this manual. If you find any mistakes or if you know of any way to improve the procedures, please let us know. Mail your letter, DA Form 2028 (Recommended Changes to Publications and Blank Forms), or DA Form 2028-2 located in the back of this manual, direct to: Commander, US Army Aviation and Missile Command, ATTN: AMSAM-MMC-MA-NP, Redstone Arsenal, AL 35898-5230. A reply will be furnished to you. You may also send in your comments electronically to our E-mail address: 2028@redstone.army.mil or by fax 256-842-6546/DSN 788-6546. Instructions for sending an electronic 2028 may be found at the back of this manual immediately preceding the hard copy 2028.

DISTRIBUTION STATEMENT A. Approved for public release; distribution is unlimited.

NOTE

This document has been reviewed for the presence of Class I Ozone Depleting Chemicals. As of Change 4, dated 29 January 1999, all references to Class I Ozone Depleting Chemicals have been removed from this document by substitution with chemicals that do not cause atmospheric ozone depletion.

TABLE OF CONTENTS

Chapter & Section		Page
CHAPTER 1	INTRODUCTION	1-1
CHAPTER 2	AIRCRAFT AND SYSTEMS DESCRIPTION AND OPERATION	2-1
Section I	Aircraft.....	2-1
Section II	Emergency Equipment	2-25
Section III	Engines and Related Systems	2-27
Section IV	Fuel System	2-39
Section V	Flight Controls.....	2-41
Section VI	Hydraulic and Pneumatic System	2-48

TABLE OF CONTENTS (Cont)

Chapter & Section		Page
Section VII	Powertrain System.....	2-53
Section VIII	Main and Tail Rotor Groups.....	2-55
Section IX	Utility Systems	2-57
Section X	Heating, Ventilating, Cooling, and Environmental Control Unit.....	2-62
Section XI	Electrical Power Supply and Distribution Systems.....	2-64
Section XII	Auxiliary Power Unit	2-71
Section XIII	Lighting.....	2-74
Section XIV	Flight Instruments.....	2-77
Section XV	Servicing, Parking, and Mooring	2-86
CHAPTER 3	AVIONICS	3-1
Section I	General.....	3-1
Section II	Communications	3-8
Section III	Navigation.....	3-32.11
Section IV	Transponder and Radar	3-75
CHAPTER 4	MISSION EQUIPMENT.....	4-1
Section I	Mission Avionics.....	4-1
Section II	Armament	4-26
Section III	Cargo Handling Systems.....	4-42
Section IV	Mission Flexible Systems.....	4-47
CHAPTER 5	OPERATING LIMITS AND RESTRICTIONS.....	5-1
Section I	General.....	5-1

TABLE OF CONTENTS (Cont)

Chapter & Section		Page
Section II	System Limits.....	5-2
Section III	Power Limits.....	5-9
Section IV	Loading Limits	5-12
Section V	Airspeed Limits	5-13
Section VI	Maneuvering Limits	5-19
Section VII	Environmental Restrictions	5-23
Section VIII	Other Limitations.....	5-24
 CHAPTER 6	 WEIGHT/BALANCE AND LOADING	 6-1
Section I	General.....	6-1
Section II	Weight and Balance	6-3
Section III	Fuel/Oil	6-5
Section IV	Personnel.....	6-7
Section V	Mission Equipment.....	6-13
Section VI	Cargo Loading	6-19
Section VII	Center of Gravity.....	6-24
 CHAPTER 7	 PERFORMANCE DATA.....	 7-1
Section I	Introduction.....	7-1
Section II	Maximum Torque Available	7-6
Section III	Hover.....	7-9
Section IV	Cruise	7-13
Section V	Optimum Cruise	7-132

TABLE OF CONTENTS (Cont)

Chapter & Section		Page
Section VI	Drag.....	7-135
Section VII	Climb - Descent.....	7-138
Section VIII	Fuel Flow.....	7-141
Section IX	Airspeed System Characteristics.....	7-143
Section X	Special Mission Performance.....	7-147
CHAPTER 7A	PERFORMANCE DATA 701C	7A-1
Section I	Introduction.....	7A-1
Section II	Maximum Torque Available.....	7A-6
Section III	Hover.....	7A-13
Section IV	Cruise.....	7A-17
Section V	Optimum Cruise.....	7A-134
Section VI	Drag.....	7A-137
Section VII	Climb-Descent.....	7A-140
Section VIII	Fuel Flow.....	7A-143
Section IX	Airspeed System Characteristics.....	7A-145
Section X	Special Mission Performance.....	7A-148
CHAPTER 8	NORMAL PROCEDURES.....	8-1
Section I	Mission Planning.....	8-1
Section II	Operating Procedures and Maneuvers.....	8-3
Section III	Instrument Flight.....	8-17
Section IV	Flight Characteristics.....	8-18
Section V	Adverse Environmental Conditions.....	8-20

TABLE OF CONTENTS (Cont)

Chapter & Section		Page
CHAPTER 9	EMERGENCY PROCEDURES	9-1
Section I	Aircraft Systems	9-1
Section II	Mission Equipment.....	9-22
APPENDIX A	REFERENCES	A-1
APPENDIX B	ABBREVIATIONS AND TERMS.....	B-1
APPENDIX C	KY-100.	C-1
INDEX	INDEX	INDEX-1

CHAPTER 1

INTRODUCTION

1.1 GENERAL.

These instructions are for use by the operator. They apply to UH-60A, UH-60L, and EH-60A helicopters.

1.2 WARNINGS, CAUTIONS, AND NOTES.

Warnings, cautions, and notes are used to emphasize important and critical instructions and are used for the following conditions:

WARNING

An operating procedure, practice, etc., which, if not correctly followed, could result in personal injury or loss of life.

CAUTION

An operating procedure, practice, etc., which, if not strictly observed, could result in damage to or destruction of equipment.

NOTE

An operating procedure, condition, etc., which it is essential to highlight.

1.3 DESCRIPTION.

This manual contains the complete operating instructions and procedures for UH-60A, UH-60L, and EH-60A helicopters. The primary mission of this helicopter is that of tactical transport of troops, medical evacuation, cargo, and reconnaissance within the capabilities of the helicopter. The observance of limitations, performance, and weight and balance data provided is mandatory. The observance of procedures is mandatory except when modification is re-

quired because of multiple emergencies, adverse weather, terrain, etc. Your flying experience is recognized and therefore, basic flight principles are not included. **IT IS REQUIRED THAT THIS MANUAL BE CARRIED IN THE HELICOPTER AT ALL TIMES.**

1.4 APPENDIX A, REFERENCES.

Appendix A is a listing of official publications cited within the manual applicable to and available for flight crews, and fault isolation/trouble references.

1.5 APPENDIX B, ABBREVIATIONS, AND TERMS.

Abbreviations listed are to be used to clarify the text in this manual only. Do not use them as standard abbreviations.

1.6 INDEX.

The index lists, in alphabetical order, every titled paragraph, figure, and table contained in this manual. Chapter 7 performance data has an additional index within the chapter.

1.7 ARMY AVIATION SAFETY PROGRAM.

Reports necessary to comply with the safety program are prescribed in AR 385-40.

1.8 DESTRUCTION OF ARMY MATERIEL TO PREVENT ENEMY USE.

For information concerning destruction of Army materiel to prevent enemy use, refer to TM 750-244-1-5. █

1.9 FORMS AND RECORDS.

Army aviators flight record and aircraft inspection and maintenance records which are to be used by crewmembers are prescribed in DA PAM 738-751 and TM 55-1500-342-23.

1.10 EXPLANATION OF CHANGE SYMBOLS.

Changes, except as noted below, to the text and tables, including new material on added pages, are indicated by a vertical line in the outer margin extending close to the entire area of the material affected: exception; pages with emergency markings, which consist of black diagonal lines around three edges, may have the vertical line or change symbol placed along the inner margin. Symbols show current changes only. A vertical line alongside the title is used to denote a change to an illustration. However, a vertical line in the outer margin, is utilized when there have been extensive changes made to an illustration. Change symbols are not used to indicate changes in the following:

- a. Introductory material.
- b. Indexes and tabular data where the change cannot be identified.
- c. Blank space resulting from the deletion of text, an illustration, or a table.
- d. Correction of minor inaccuracies, such as spelling, punctuation, relocation of material, etc., unless such correction changes the meaning of instructive information and procedures.

1.11 SERIES AND EFFECTIVITY CODES.

Designator symbols listed below, are used to show limited effectivity of airframe information material in conjunction with text content, paragraph titles, and illustrations. Designators may be used to indicate proper effectivity, unless the material applies to all models and configuration within the manual. Designator symbols precede procedural steps in Chapters 8 and 9. If the material applies to all series and configurations, no designator symbol will be used.

DESIGNATOR SYMBOL	APPLICATION
UH	UH-60A, UH-60L information.
UH-60A	UH-60A information. peculiar
UH-60L	UH-60L information. peculiar

DESIGNATOR SYMBOL

EH

APPLICATION

EH-60A peculiar information.

NV

Aircraft with NVG lighting.

ES

Aircraft with External Stores Support Systems.

700

UH-60A, EH-60A aircraft equipped with T700-GE-700 engines.

701C

UH-60L aircraft equipped with T700-GE-701C engines.

VOL

Aircraft with volcano installed.

GPS

Aircraft with global positioning system (GPS) installed.

ERFS

Aircraft with Extended Range Fuel System.

AFMS

Aircraft with Auxiliary Fuel Management System.

1.12 HIGH DRAG SYMBOL.

This symbol  will be used throughout this manual to designate information applicable to the high drag configuration described in Chapters 7 and 7A.

1.13 PLACARDED AIRCRAFT SYMBOL.

This symbol  will be used throughout this manual to designate applicability to helicopters which have torque placard limitations.

1.14 USE OF WORDS SHALL, SHOULD, AND MAY.

Within this technical manual the word shall is used to indicate a mandatory requirement. The word should is used to indicate a nonmandatory but preferred method of accomplishment. The word may is used to indicate an acceptable method of accomplishment.

CHAPTER 2

AIRCRAFT AND SYSTEMS DESCRIPTION AND OPERATION

Section I AIRCRAFT

2.1 GENERAL.

This chapter describes the UH-60A, UH-60L, and EH-60A helicopter's systems and flight controls. The functioning of electrical and mechanical components is simplified where more detailed knowledge is not necessary.

2.2 UH-60A. UH-60A

The UH-60A (BLACK HAWK) (Figure 2-1) is a twin turbine engine, single rotor, semimonocoque fuselage, rotary wing helicopter. Primary mission capability of the helicopter is tactical transport of troops, supplies and equipment. Secondary missions include training, mobilization, development of new and improved concepts, and support of disaster relief. The main rotor system has four blades made of titanium/fiberglass. The drive train consists of a main transmission, intermediate gear box and tail rotor gear box with interconnecting shafts. The propulsion system has two T700-GE-700 engines operating in parallel. The nonretractable landing gear consists of the main landing gear and a tailwheel. The armament consists of two 7.62 mm machine-guns, one on each side of the helicopter in the forward cabin. Detailed descriptions of these systems are given in these chapters. For additional weight information, refer to Chapters 5, 6, and 7. Kit installations for the helicopter consist of range extension tanks, rescue hoist, medical evacuation, infrared suppression, blade anti-icing/deicing, blackout devices, snow skis, winterization and static/rappelling kit. Refer to this chapter and Chapter 4 for kit descriptions.

2.3 UH-60L. UH-60L

The UH-60L helicopter is the same as the UH-60A helicopter except engines T700-GE-701C replace T700-GE-700. The main transmission is replaced by an improved durability gearbox (IDGB).

2.4 EH-60A. EH

The EH-60A helicopter is a modified UH-60A (Figure 2-1) with a crew of four. The Mission equipment consists of electronic systems with modifications that will ensure that the mission requirements are met. The EH-60A system includes air conditioning, helicopter survivability equipment, and avionics equipment. An electronics compartment within the transition section is used for avionics equipment. The compartment can be entered from the right side of the helicopter. The mission systems employ two operators: The DF (ESM) operator controlling the electronics surveillance functions, and the electronics countermeasure (ECM) operator controlling the active countermeasure functions. The EH-60A can operate independently or in conjunction with up to two additional, similarly equipped, aircraft. When operating in the multisystem mode, secured air-to-air communications are provided for automatic tasking between aircraft. Secured air-to-ground communications are also provided for voice reporting purposes.

2.5 DIMENSIONS.

Principal dimensions of the helicopter are based on the cyclic stick and tail rotor pedals being centered and the collective stick being in its lowest position. All dimensions are approximate and they are as shown on Figure 2-2.

2.6 TURNING RADIUS AND GROUND CLEARANCE.

WARNING

Main rotor clearance in Figure 2-3 is shown with cyclic centered and level ground. Cyclic displacement or sloping terrain may cause rotor blade clearance to be significantly less.

For information on turning radius and ground clearance, see Figure 2-3.

2.7 COMPARTMENT DIAGRAM.

2.7.1 Compartment Diagram. **UH** The fuselage is divided into two main compartments, the cockpit and cabin. The cockpit (Figure 2-4) is at the front of the helicopter with the pilots sitting in parallel, each with a set of flight controls and instruments. Operation of electrical controls is shared by both. The cabin compartment contains space for crew chief seating, troop seating, litter installation and cargo. Restraint of cargo is by tiedown rings installed in the floor. Two stowage compartments, at the rear of the cabin over the main fuel tanks, are for flyaway equipment (Figure 6-11). The equipment storage compartments are reached from inside the cabin. A gust lock control, APU accumulator handpump and pressure gage, and APU ESU are also installed (Figure 2-5).

2.7.2 Compartment Diagram. **EH** A fixed observer seat is installed to allow observation of either operator position (Figure 2-6). Floor attachments are provided for securing rack mounts and seats. Blackout curtains may be used to eliminate any light intrusion into the cockpit during night operations, or any glare on the operator's console during day operations. Blackout curtains may be used between cockpit and cabin during NVG operations.

2.8 UPPER AND LOWER CONSOLES.

All cockpit electrical controls are on the upper and lower consoles and instrument panel. The upper console (Figure 2-7), overhead between pilot and copilot, contains engine controls, fire emergency controls, heater and windshield

wiper controls, internal and external light controls, electrical systems and miscellaneous helicopter system controls. The rear portion of the upper panel contains the dc essential bus circuit breaker panels. The lower console (Figure 2-8) next to the base of the instrument panel and extending through the cockpit between the pilot and copilot, is easily reached by either pilot. The console is arranged with communication panels, navigational panels and flight attitude/stability controls. The rear part of the console houses the battery bus and battery utility bus circuit breaker panels, and parking brake handle.

2.9 LANDING GEAR SYSTEM.

The helicopter has a nonretractable landing gear consisting of two main gear assemblies and a tailwheel assembly. The landing gear permits helicopter takeoffs and landings on slopes in any direction. The system incorporates a jack and kneel feature that permits manual raising or lowering of the fuselage for air transportability. A landing gear weight-on-wheels (WOW) switch is installed on the left landing gear to control operation of selected systems (Table 2-1). The switch is deactivated when the weight of the helicopter is on the landing gear. On helicopters equipped with ESSS fixed provisions, a WOW switch is also installed on the right landing gear drag beam to provide ac underfrequency cutout and external stores jettison. The left WOW switch provides all other WOW functions as without ESSS provisions and the **EMER JETT ALL** capabilities. See Table 2-1 for reference.

2.9.1 Main Landing Gear. The main landing gear is mounted on each side of the helicopter forward of center of gravity (Figure 2-1). Each individual landing gear has a single wheel, a drag beam, and a two-stage oleo shock strut. The lower stage will absorb energy from landings up to 10 feet-per-second (fps). Above 10 fps the upper stage and lower stage combine to absorb loads up to 39 fps (about 11.25 Gs).

2.9.2 Wheel Brake System. Main landing gear wheels have disc hydraulic brakes. The self-contained self-adjusting system is operated by the pilot's and copilot's tail rotor pedals. The brakes have a visual brake puck wear indicator. Each wheel brake consists of two steel rotating discs, brake pucks and a housing that contains the hydraulic pistons. The parking brake handle, marked **PARKING BRAKE**, is on the right side of the lower console (Figure 2-8). A hand-operated parking brake handle allows brakes to be locked by either pilot or copilot after brake pressure is applied. The parking brakes are applied by pressing the toe brake pedals, pulling the parking brake handle to its fully extended position, and then releasing the toe brakes while holding the handle out. An advisory light will go on, indi-

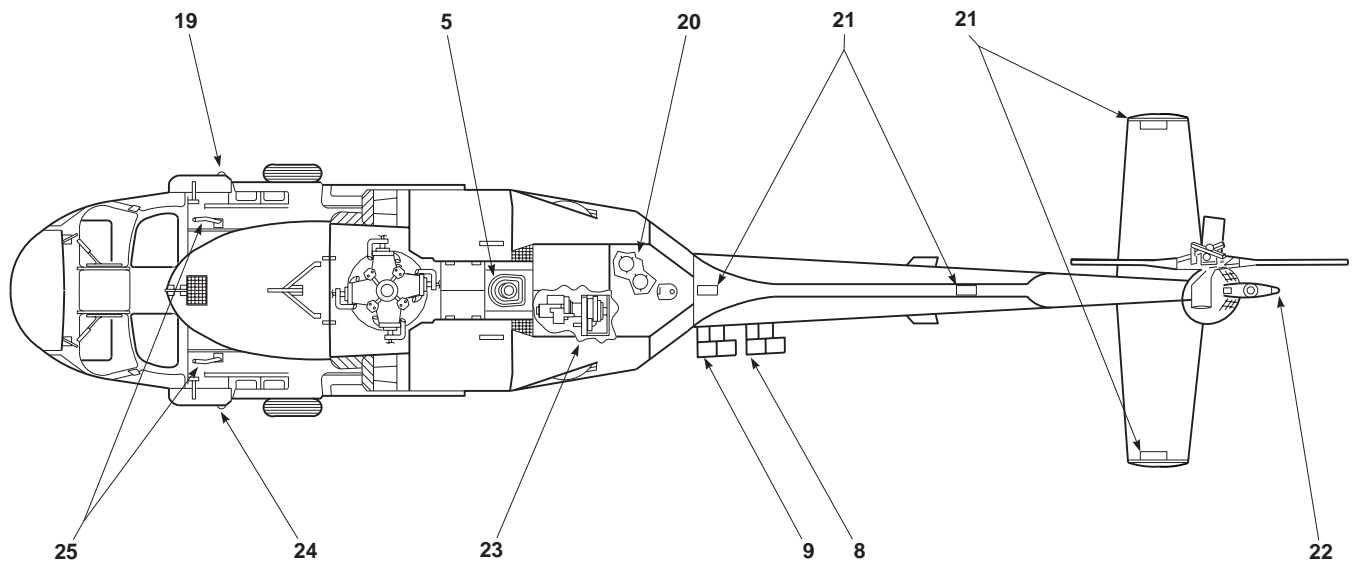
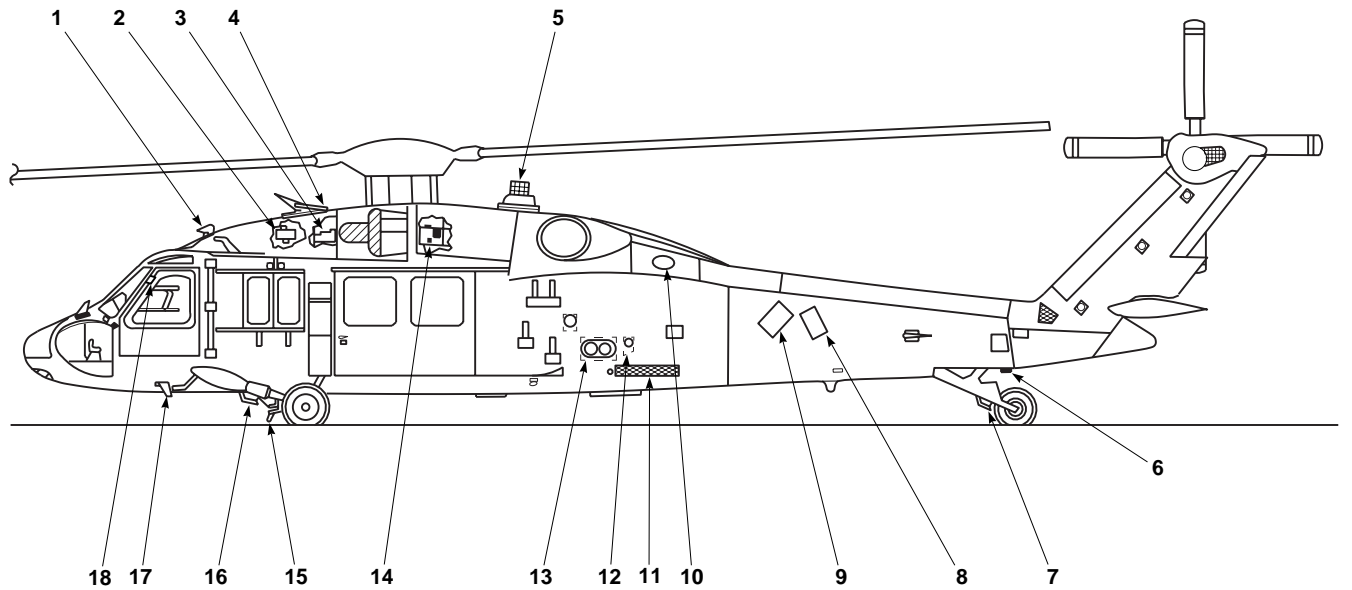

- | | |
|--|---|
| <ul style="list-style-type: none"> * 1. PITOT CUTTER 2. BACK HYDRAULIC PUMP 3. NO. 1 HYDRAULIC PUMP AND NO.1 GENERATOR * 4. UPPER (ROTOR PYLON) CUTTER 5. INFRARED COUNTERMEASURE TRANSMITTER 6. AFT MAINTENANCE LIGHT RECEPTACLE * 7. TAIL LANDING GEAR DEFLECTOR EH 8. FLARE DISPENSER 9. CHAFF DISPENSER 10. APU EXHAUST PORT EH 11. COOLING AIR INLET PORT 12. PNEUMATIC PORT 13. PRESSURE AND CLOSED CIRCUIT REFUELING PORTS | <ul style="list-style-type: none"> 14. NO. 1 ENGINE * 15. MAIN LANDING GEAR DEFLECTOR / CUTTER * 16. LANDING GEAR JOINT DEFLECTOR * 17. STEP AND EXTENSION DEFLECTOR * 18. DOOR HINGE DEFLECTOR 19. RIGHT POSITION LIGHT (GREEN) 20. FIRE EXTINGUISHER BOTTLES 21. FORMATION LIGHTS 22. TAIL POSITION LIGHT (WHITE) 23. APU 24. LEFT POSITION LIGHT (RED) 25. PITOT TUBES |
|--|---|

* ON HELICOPTERS EQUIPPED WITH WIRE STRIKE PROTECTION SYSTEM

AA0403_1A
SA

Figure 2-1. General Arrangement (Sheet 1 of 2)

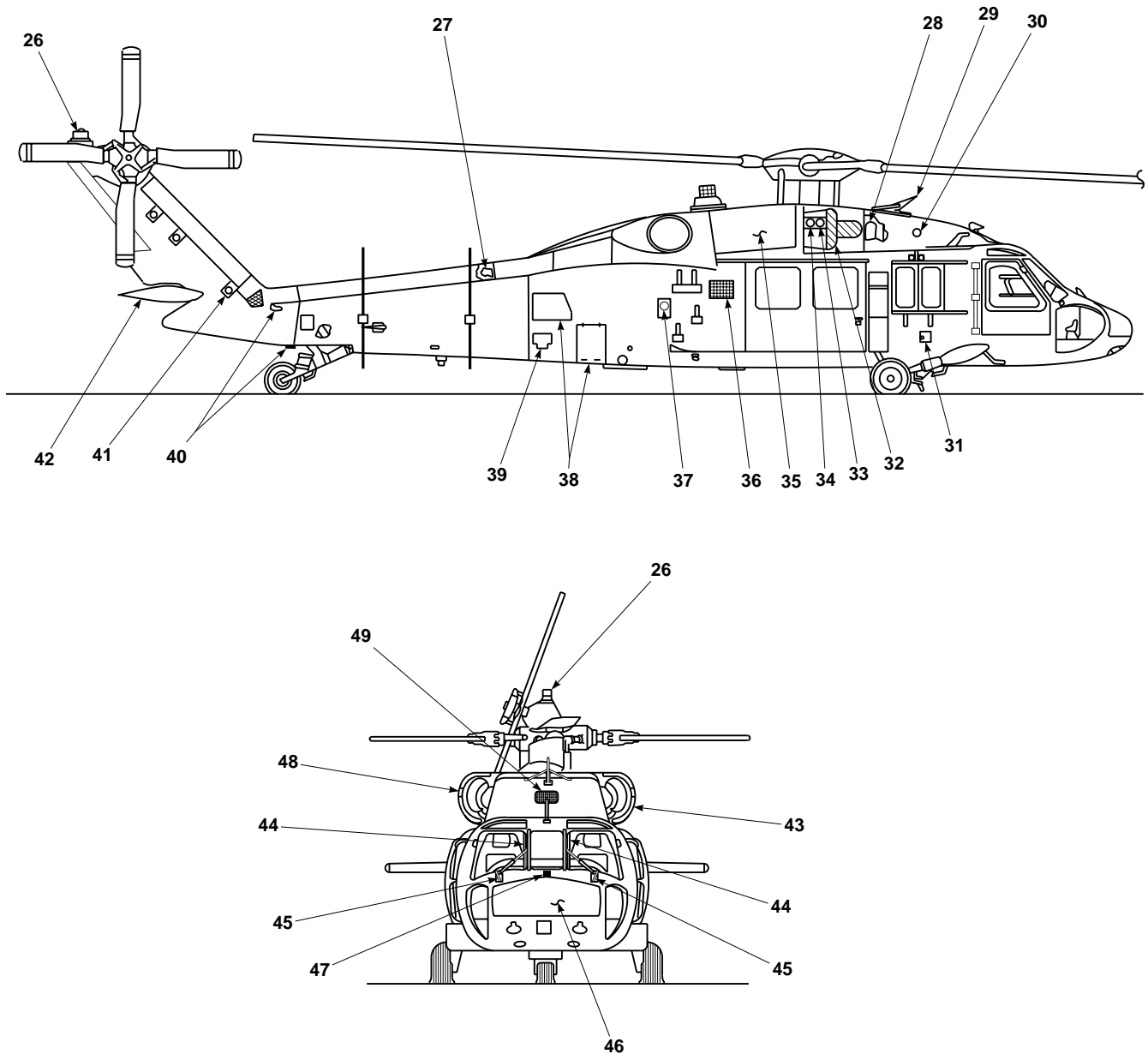

- 26. UPPER ANTICOLLISION LIGHT
- 27. TAIL DRIVE SHAFT
- 28. NO. 2 HYDRAULIC PUMP AND NO. 2 GENERATOR
- * 29. PYLON CUTTER
- 30. HEATER AIR INTAKE PORT
- 31. EXTERNAL ELECTRICAL POWER RECEPTACLE
- 32. NO. 2. ENGINE
- 33. ICE DETECTOR
- 34. AMBIENT SENSE PORT
- 35. ENGINE FAIRING / WORK PLATFORM (SAME BOTH SIDES)
- EH** 36. CONDENSER EXHAUST / STEP
- 37. GRAVITY REFUELING PORT (SAME BOTH SIDES)

- EH** 38. AFT AVIONICS COMPARTMENT DOORS
- EH** 39. IINS BLOWER INLET FILTER
- 40. TAIL PYLON FOLD HINGES
- 41. TAIL PYLON SERVICE LADDER (SAME BOTH SIDES)
- 42. STABILATOR
- 43. ENGINE BAY AREA COOLING AIR INTAKE (SAME BOTH SIDES)
- * 44. WINDSHIELD POST DEFLECTOR
- * 45. WINDSHIELD WIPER DEFLECTOR
- 46. AVIONICS COMPARTMENT
- 47. OAT SENSOR
- 48. ICE DETECTOR
- 49. PYLON COOLING AIR INTAKE

* ON HELICOPTERS EQUIPPED WITH WIRE STRIKE PROTECTION SYSTEM

AA0403_2B
SA

Figure 2-1. General Arrangement (Sheet 2 of 2)

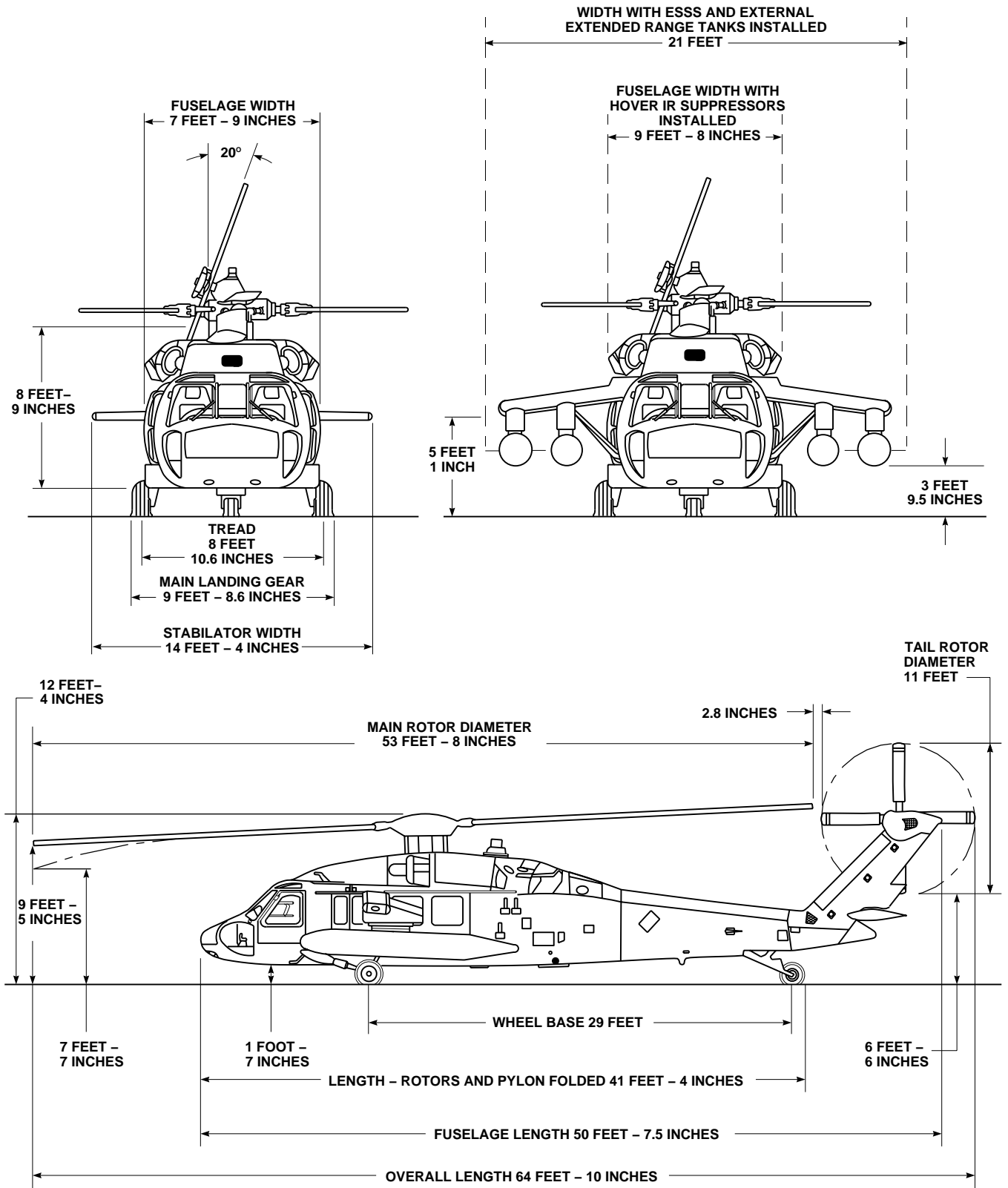

AA0514B
SA

Figure 2-2. Principal Dimensions

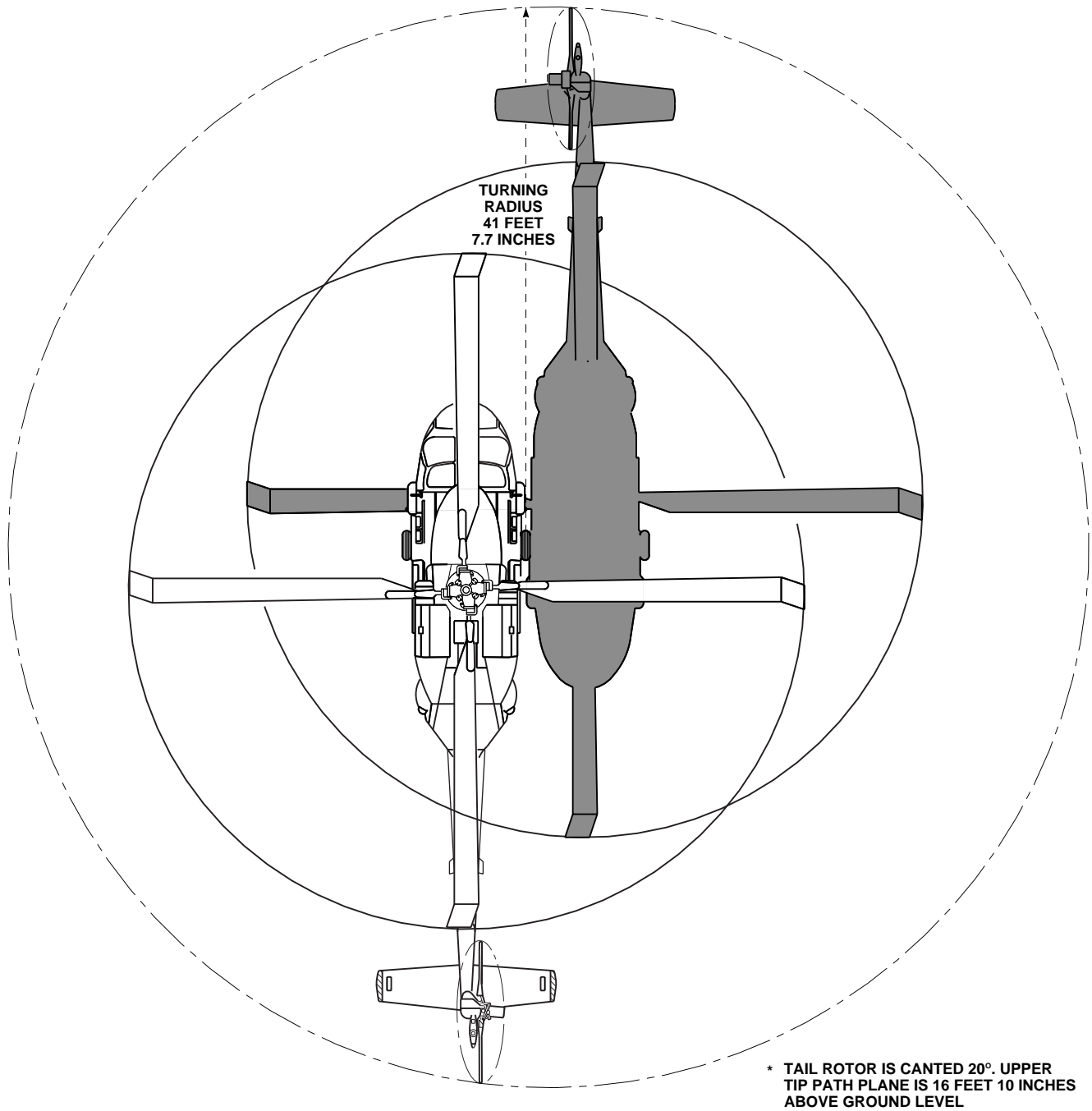

* TAIL ROTOR IS CANTED 20°. UPPER TIP PATH PLANE IS 16 FEET 10 INCHES ABOVE GROUND LEVEL

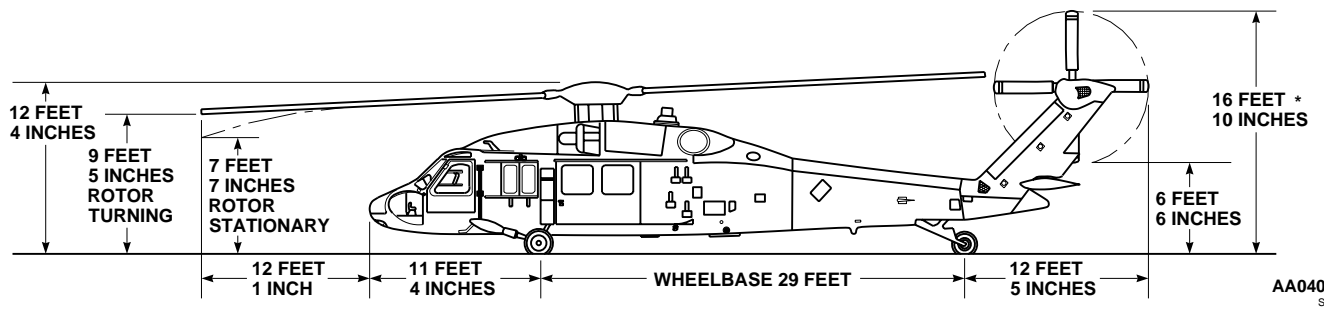

AA0402
SA

Figure 2-3. Turning Radius and Clearance

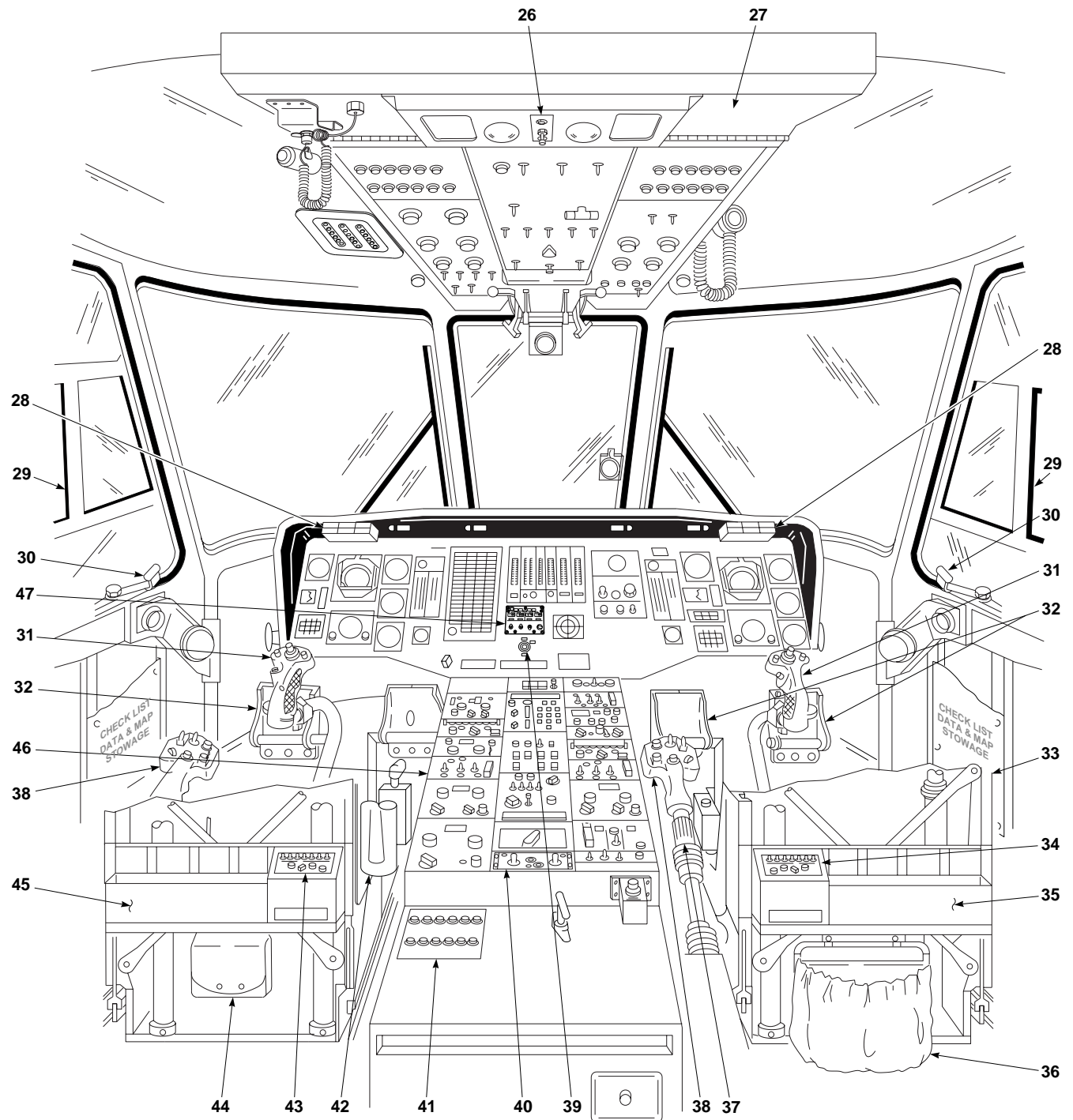

- | | | |
|------------------------------------|---|---|
| 26. COCKPIT FLOODLIGHT CONTROL | 34. CREW CHIEF / GUNNER ICS CONTROL PANEL | 41. BATTERY / BATTERY UTILITY BUS CIRCUIT BREAKER PANEL |
| 27. UPPER CONSOLE | 35. CREW CHIEF AMMUNITION / GRENADE STORAGE COMPARTMENT | 42. FIRE EXTINGUISHER |
| 28. MASTER WARNING PANEL | 36. STOWAGE BAG | 43. GUNNER'S ICS CONTROL PANEL |
| 29. SLIDING WINDOW | 37. COLLECTIVE STICK FRICTION CONTROL | 44. FIRST AID KIT |
| 30. COCKPIT DOOR EMERGENCY RELEASE | 38. COLLECTIVE STICK GRIP | 45. GUNNER'S AMMUNITION / GRENADE |
| 31. CYCLIC STICK | 39. ENGINE IGNITION KEYLOCK | 46. COPILOT'S SIDE LOWER CONSOLE |
| 32. DIRECTIONAL CONTROL PEDALS | 40. LOWER CONSOLE | 47. AUXILIARY FUEL MANAGEMENT PANEL |
| 33. PILOT'S SEAT | | |

AB0822
SA

Figure 2-4. Cockpit Diagram (Sheet 2 of 2)

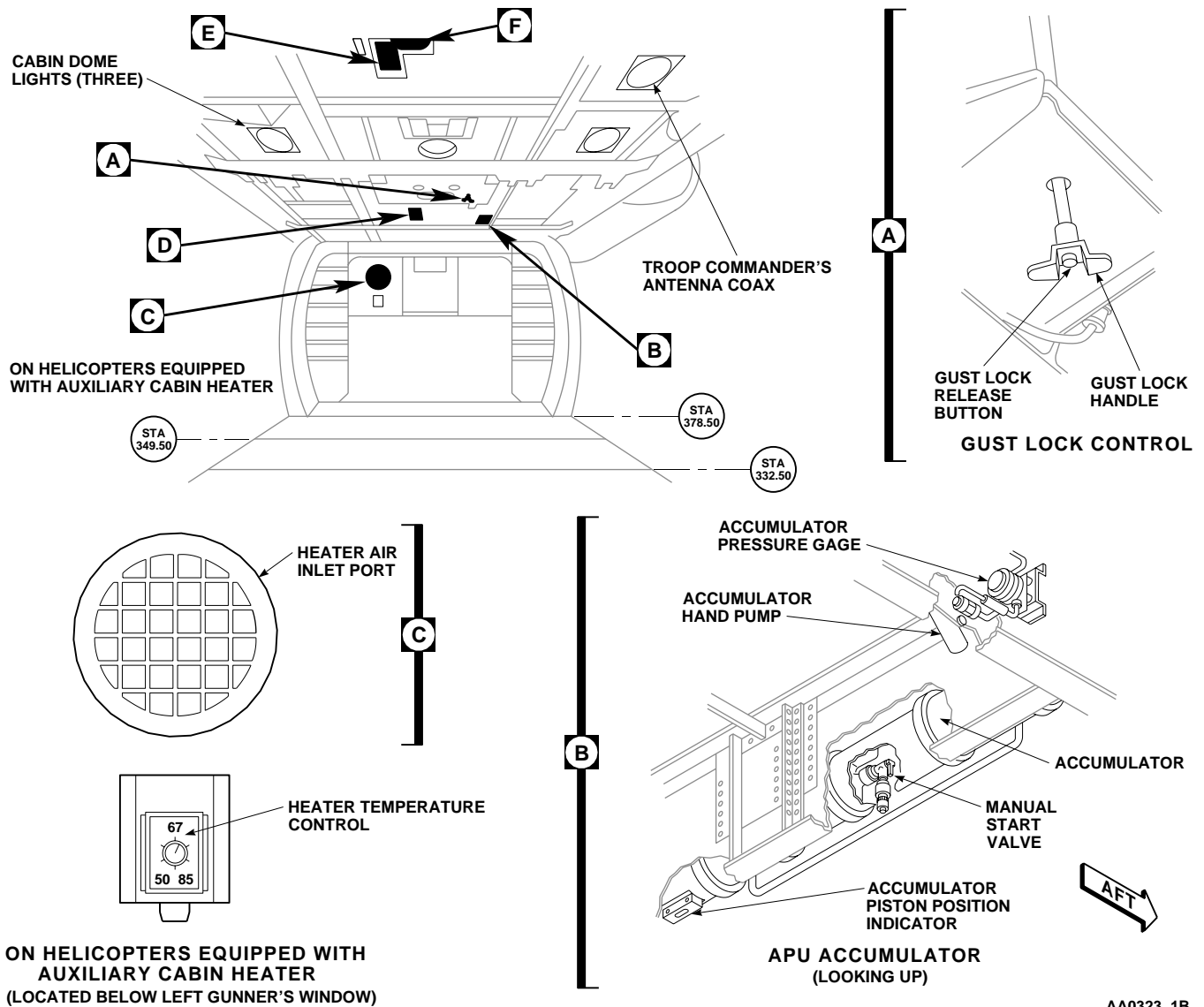

Figure 2-5. Cabin Interior (Sheet 1 of 2)

ating **PARKING BRAKE ON**. Pressing either pilot or copilot left brake pedal will release the parking brakes, the handle will return to the off position and the advisory light will go off. Power for the advisory light comes from the No. 1 dc primary bus through a circuit breaker marked **LIGHTS ADVSY**.

2.9.3 Tail Landing Gear. The tail landing gear (Figure 2-1) is below the rear section of the tail cone. It has a two-stage oleo shock strut, tailwheel lock system fork assembly, yoke assembly, and a wheel and tire. The fork assembly is the attachment point for the tailwheel and allows the wheel to swivel 360°. The tailwheel can be locked in a trail position by a **TAILWHEEL** switch in the cockpit

indicating **LOCK** or **UNLK** (Figure 2-8). The fork is locked by an electrical actuator through a bellcrank and locking pin. When the pin is extended, the switch will indicate **LOCK**. When the pin is retracted, the switch will indicate **UNLK**. Power to operate the locking system is by the dc essential bus through a circuit breaker marked **TAILWHEEL LOCK**.

2.10 INSTRUMENT PANEL.

2.10.1 Instrument Panel. **UH** Engine and dual flight instruments are on the one-piece instrument panel (Figure 2-9). The panel is tilted back 30°. The master warning panels are mounted on the upper instrument panel below the

↙ FAULT INDICATION ↘ FAULTS

	T-62T-40-1				DECODED BITE INFORMATION
	BITE #				
	1	2	3	4	
START SEQUENCE	● ● ● ●	● ● ● ●	● ● ● ●	● ● ● ●	RESET
	○ ● ● ●	○ ● ● ●	○ ● ● ●	○ ● ● ●	START FUEL VALVE & EXCITER SIGNAL OUT (5%)
	○ ○ ● ●	○ ○ ● ●	○ ○ ● ●	○ ○ ● ●	MAIN FUEL VALVE SIGNAL OUT (14%)
	○ ○ ○ ●	○ ○ ○ ●	○ ○ ○ ●	○ ○ ○ ●	START FUEL VALVE & EXCITER SIGNAL OFF (70%)
OPERATION	○ ○ ○ ○	○ ○ ○ ○	○ ○ ○ ○	○ ○ ○ ○	90% RPM SWITCH ON
	● ● ● ●	● ● ● ●	● ● ● ●	● ● ● ●	READY FOR SERVICE (90% + 1.5 SEC)
	○ ● ● ●	○ ● ● ●	○ ● ● ●	○ ● ● ●	PROCESSOR BOARD FAILURE
	● ○ ● ●	● ○ ● ●	● ○ ● ●	● ○ ● ●	SENSOR/DATA BOARD FAILURE
	○ ○ ● ●	○ ○ ● ●	○ ○ ● ●	○ ○ ● ●	OVERTEMPERATURE
	● ● ○ ●	● ● ○ ●	● ● ○ ●	● ● ○ ●	OVERSPEED
	○ ● ○ ●	○ ● ○ ●	○ ● ○ ●	○ ● ○ ●	UNDERSPEED
	● ○ ○ ●	● ○ ○ ●	● ○ ○ ●	● ○ ○ ●	FAIL TO START
	○ ○ ○ ●	○ ○ ○ ●	○ ○ ○ ●	○ ○ ○ ●	LOW OIL PRESSURE
	● ● ● ○	● ● ● ○	● ● ● ○	● ● ● ○	HIGH OIL TEMPERATURE (WARNING)
	○ ○ ○ ○	○ ○ ○ ○	○ ○ ○ ○	○ ○ ○ ○	FAIL TO LIGHT (NO DATA)
	● ● ● ○	● ● ● ○	● ● ● ○	● ● ● ○	SHORTED THERMOCOUPLE PROBE (WARNING)
	● ● ○ ○	● ● ○ ○	● ● ○ ○	● ● ○ ○	OPEN THERMOCOUPLE
	● ○ ○ ○	● ○ ○ ○	● ○ ○ ○	● ○ ○ ○	PROCESSOR SEQUENCE FAIL
	○ ○ ○ ○	○ ○ ○ ○	○ ○ ○ ○	○ ○ ○ ○	NO DATA

APU ELECTRONIC SEQUENCE UNIT FAULT INDICATION
(ON HELICOPTERS EQUIPPED WITH T-62T-40-1 APU)

↙ FAULT INDICATION ↘ FAULTS

	GTC-P36-150				DECODED BITE INFORMATION
	BITE #				
	1	2	3	4	
START SEQUENCE	● ● ● ●	● ● ● ●	● ● ● ●	● ● ● ●	RESET (START INITIATED)
	○ ● ● ●	○ ● ● ●	○ ● ● ●	○ ● ● ●	FUEL VALVE AND IGNITION SIGNAL ON (5%)
	○ ○ ● ●	○ ○ ● ●	○ ○ ● ●	○ ○ ● ●	START VALVE SIGNAL OFF (70%)
	○ ○ ○ ●	○ ○ ○ ●	○ ○ ○ ●	○ ○ ○ ●	IGNITION SIGNAL OFF (95%)
OPERATION	● ● ● ●	● ● ● ●	● ● ● ●	● ● ● ●	READY FOR SERVICE (LOSS OF DC POWER)
	○ ● ● ●	○ ● ● ●	○ ● ● ●	○ ● ● ●	ESU FAILURE
	● ○ ● ●	● ○ ● ●	● ○ ● ●	● ○ ● ●	A/C START SYSTEM FAILURE
	○ ○ ● ●	○ ○ ● ●	○ ○ ● ●	○ ○ ● ●	OVERTEMPERATURE
	● ● ○ ●	● ● ○ ●	● ● ○ ●	● ● ○ ●	OVERSPEED
	○ ● ○ ●	○ ● ○ ●	○ ● ○ ●	○ ● ○ ●	UNDERSPEED
	● ○ ○ ●	● ○ ○ ●	● ○ ○ ●	● ○ ○ ●	FAIL TO START
	○ ○ ○ ●	○ ○ ○ ●	○ ○ ○ ●	○ ○ ○ ●	LOW OIL PRESSURE
	● ● ● ○	● ● ● ○	● ● ● ○	● ● ● ○	OIL PRESSURE SWITCH FAILED
	○ ● ● ○	○ ● ● ○	○ ● ● ○	○ ● ● ○	THERMOCOUPLE FAILED
	● ○ ● ○	● ○ ● ○	● ○ ● ○	● ○ ● ○	MONOPOLE FAILED
	● ● ○ ○	● ● ○ ○	● ● ○ ○	● ● ○ ○	FUEL SOLENOID FAILED
	○ ○ ○ ○	○ ○ ○ ○	○ ○ ○ ○	○ ○ ○ ○	FUEL TORQUE MOTOR FAILED
	○ ○ ● ○	○ ○ ● ○	○ ○ ● ○	○ ○ ● ○	IGNITION UNIT FAILED
	○ ● ○ ○	○ ● ○ ○	○ ● ○ ○	○ ● ○ ○	HOT SENSOR FAILED
○ ○ ○ ○	○ ○ ○ ○	○ ○ ○ ○	○ ○ ○ ○	NO DATA	

APU ELECTRONIC SEQUENCE UNIT FAULT INDICATION
(ON HELICOPTERS EQUIPPED WITH GTC-P36-150 APU)

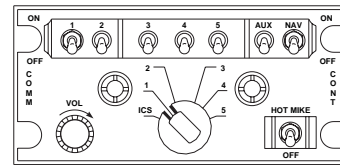

TROOP COMMANDER'S ICS CONTROL

E

D

F

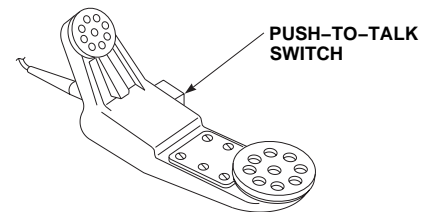

TROOP COMMANDER'S HANDSET

AA0323_2A
SA

Figure 2-5. Cabin Interior (Sheet 2 of 2)

glare shield, to inform the pilot of conditions that require immediate action.

2.10.2 Instrument Panel. **EH** The instrument panel of the EH-60A is as shown on Figure 2-9. Refer to Chapter 3 for description and operation of systems switch panels and Chapter 4 for **BDHI**, **CREW CALL** switch, **FLARE** switch and **ECM ANTENNA** switch and countermeasure set ALQ-156.

2.10.3 Vertical Instrument Display System (VIDS). The VIDS (Figure 2-9) consists of a vertical strip central display unit (CDU), two vertical strip pilot display units (PDU), and two signal data converters (SDC). Those read-

ings are shown by ascending and descending columns of multicolored lights (red, yellow, and green) measured against vertical scales which operate in this manner: the segments will light in normal progression and remain on as the received signal level increases. Those scales will go off in normal progression as the received signal level decreases. Scales with red-coded and/or amber-coded segments below green-coded segments operate in this manner: When the received signal level is zero or bottom scale, the segments will light in normal progression and will remain on. When the first segment above the red or amber range goes on, all red-coded or amber-coded segments will go off. These segments will remain off until the received signal level indicates a reading at or within the red or amber range. At that

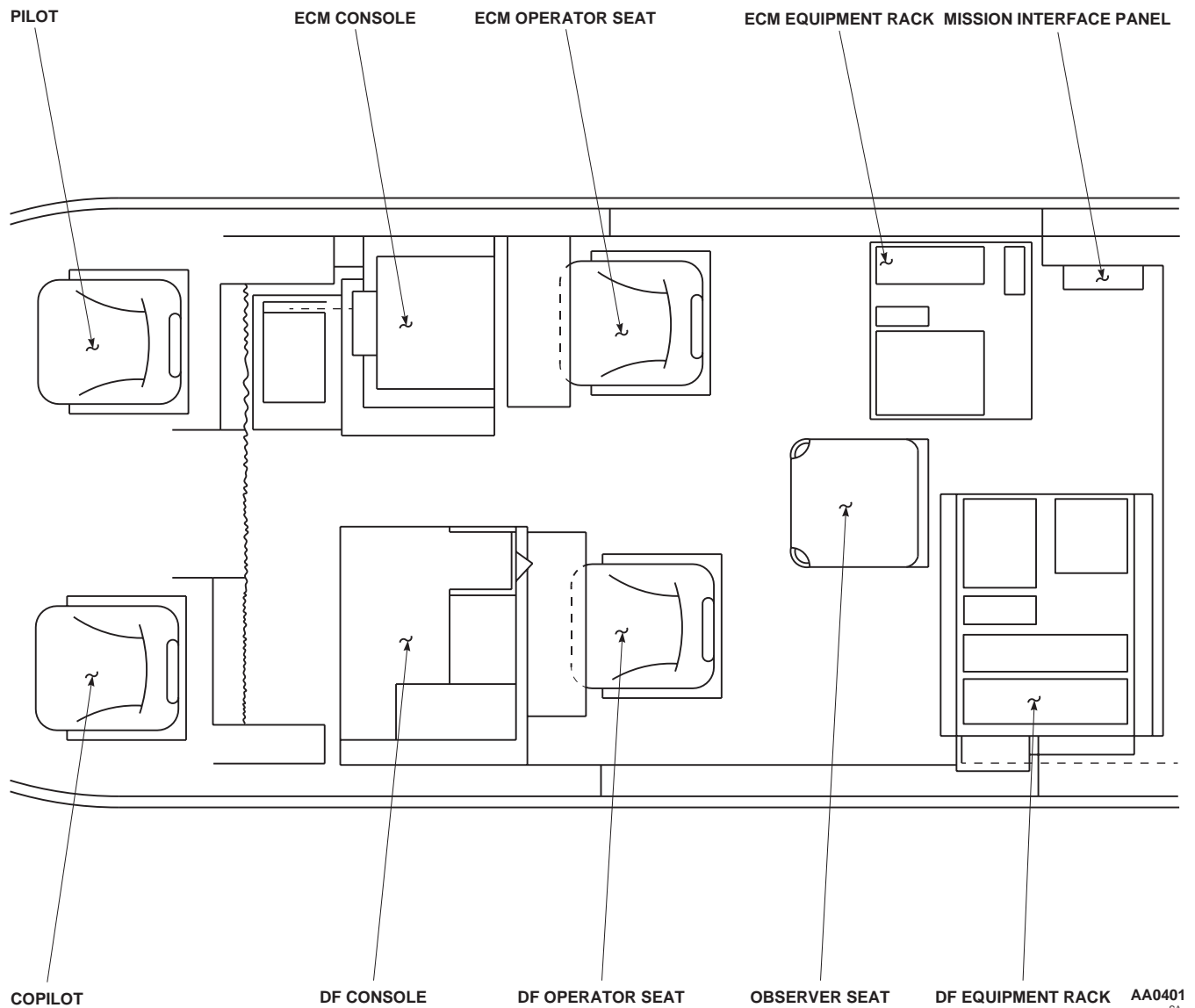

Figure 2-6. Cabin Mission Equipment Arrangement **EH**

time all red-coded or amber-coded segments will go on and the scale display will either go on or go off in normal progression, depending upon the received signal level. The CDU and PDUs contain photocells that automatically adjust lighting of the indicators with respect to ambient light. If any one of the three photocells should fail, the lights on the vertical scales of the PDUs or CDU may not be at the optimum brightness for the ambient conditions. The **DIM** knob on the CDU contains an override capability which allows the pilot to manually set the display light level. The SDCs receive parameter data from the No. 1 and No. 2 engines, transmission, and fuel system; provides processing and transmits the resulting signal data to the instrument

display. The No. 1 engine instruments on the CDU and copilot's PDU, receive signal data from the No. 1 SDC (CHAN 1). The No. 2 engine and main transmission instruments on the CDU and pilot's PDU, receives signal data from the No. 2 SDC (CHAN 2). If either SDC fails, the corresponding **CHAN 1** or **2** light will go on, and it is likely the pilot's or copilot's PDU and the corresponding instruments will fail. Failure of a lamp power supply within an SDC will cause every second display light on the CDU to go off. Both SDCs receive **% RPM 1** and **2**, **% RPM R** and **% TRQ** information from both engines. Therefore if one SDC fails only one PDU will provide **% RPM 1** and **2** and **% TRQ** for both engines.

Table 2-1. Weight-On-Wheels Functions

WOW SWITCH FUNCTION	ON GROUND	IN FLIGHT
Backup Pump Automatic Operation	Disabled (Except when APU accumulator is low)	Enabled
Hydraulic Leak Test System	Enabled	Disabled
Backup Pump Thermal Switch	Enabled	Disabled
Low % RPM R Audio Warning	Disabled	Enabled
SAS/FPS Computer	Degraded	Enabled
Generator Underfrequency Protection	Enabled	Disabled
IFF Mode 4 Operation	Disabled Automatic Zeroize	Enabled Automatic Zeroize
External Stores Jettison ES	Disabled	Enabled
M130 Control	Disabled	Enabled
AUX FUEL INCR/DECR Switch ES	Enabled	Disabled
5 minute delay before continuous BIT (CBIT) monitors attitude sensor after AFMP power up AFMS	Enabled	Disabled
AFMP Power up BIT (PBIT) and Initiated BIT (IBIT) AFMS	Enabled	Disabled

2.10.4 Central Display Unit (CDU). The CDU (Figure 2-9) contains instruments that display fuel quantity, transmission oil temperature and pressure, engine oil temperature and pressure, turbine gas temperature (TGT), and gas generator speed (Ng) readings. Those readings are shown by ascending and descending columns of multicolored lights (red, yellow, and green) measured against vertical scales. If the instrument contains low range turnoff (red or yellow lights below green lights) they will go off when the system is operating within the normal range (green). If the instrument contains yellow or red lights above the green range, the green as well as the yellow or red will stay on when operating above the green range. The operating ranges for the different instruments are shown in Figures 5-1, 5-2, and 5-3. Digital readouts are also installed on the **TOTAL FUEL** quantity, **TGT**, and **Ng** gages.

2.10.4.1 Lamp Test System. The lamp test provides a means of electrically checking all CDU scale lamps, digital readouts, and **% RPM RTR OVERSPEED** lights on the PDUs. When the **PUSH TO TEST** switch on the CDU is pressed, all CDU scale lamps should light, digital readouts should display **888**, and three **RTR OVERSPEED** lights on the PDUs should be on.

2.10.4.2 Dim Control. The **DIM** control allows the pilot to set a desired display light level of the CDU and PDUs in accordance with the ambient light, or override the auto-dim sensors. If the auto-dim circuitry should fail or malfunction, turn the **DIM** control fully clockwise to regain illumination of the CDU and PDUs.

2.10.4.3 CDU and PDU Digital Control. An **ON, OFF DIGITS** control switch is on the CDU (Figure 2-9) to turn on or off the digital readout displays on the CDU and PDUs. If a digital processor fails, all digital displays will go off.

2.10.5 Pilot's Display Unit (PDU). The PDU (Figure 2-9) displays to the pilot engine power turbine speed (**% RPM 1** and **2**), rotor speed (**% RPM R**), and torque (**% TRQ**). Readings are shown by ascending and descending columns of multicolored lights (red, yellow, and green) measured against vertical scales. A **TEST** switch provides a means of electrically checking all PDU scale lamps and digital readouts. When the **TEST** switch is pressed, all PDU scale lamps should light and digital readouts should display **188**. The **% RPM** indicators contain low range turnoff below the normal operating range. Three overspeed lights at the top will go on from left to right when a corresponding

rotor speed of 127%, 137%, and 142% is reached. Once a light is turned on, a latch prevents it from going off until reset by maintenance. Power for the PDUs is from No. 1 and No. 2 ac and dc primary buses through circuit breakers

marked **NO. 1 AC INST/NO. 1 DC INST** and **NO. 2 AC INST/NO. 2 DC INST** respectively. See Figures 5-1, 5-2, and 5-3 for instrument markings.

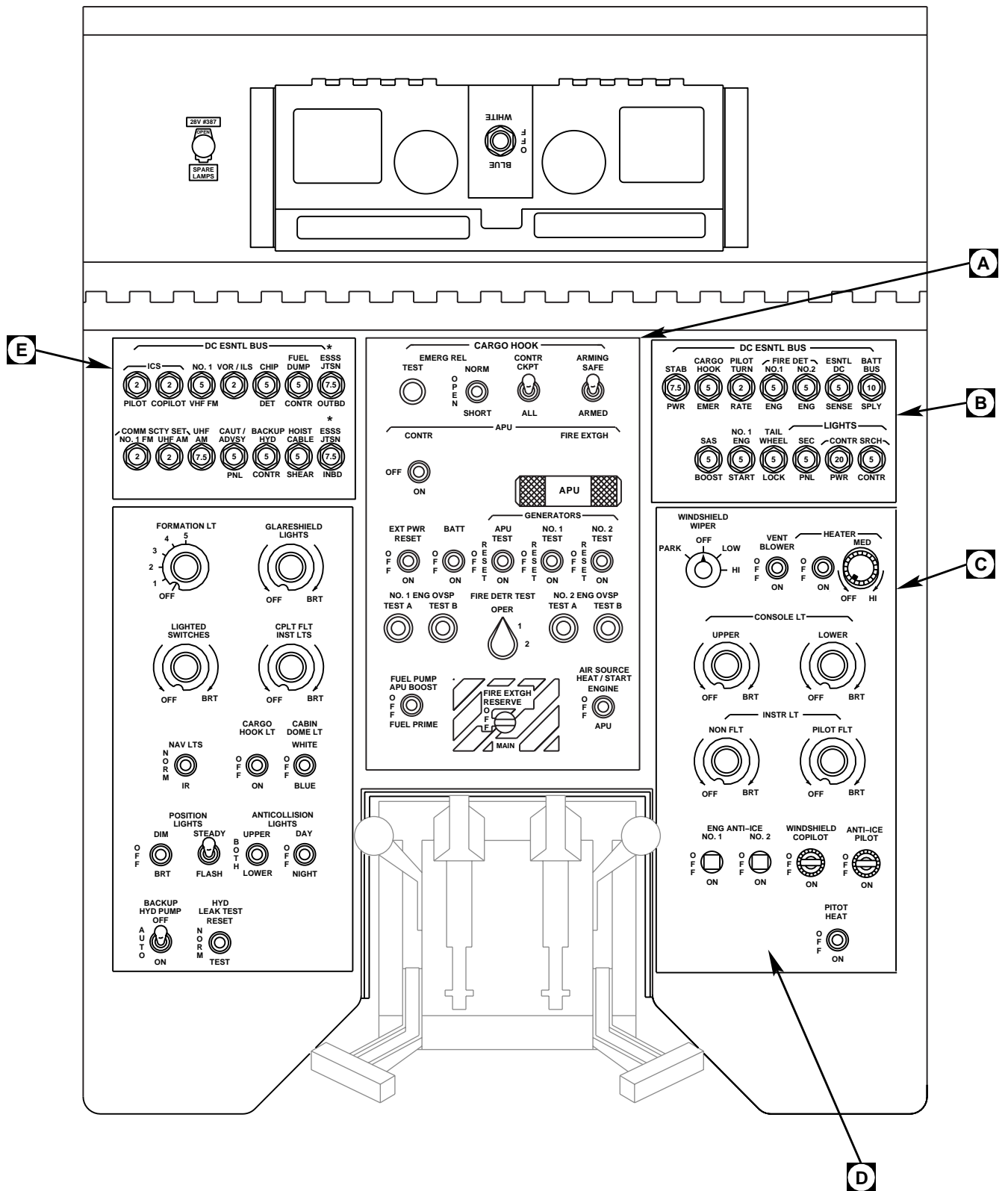
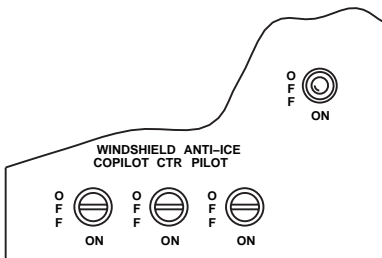
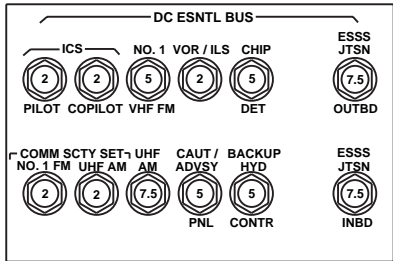
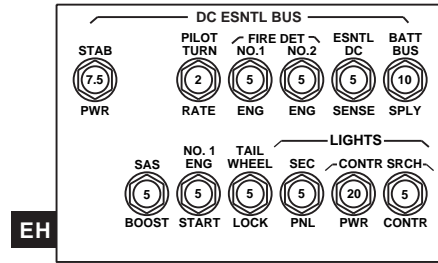
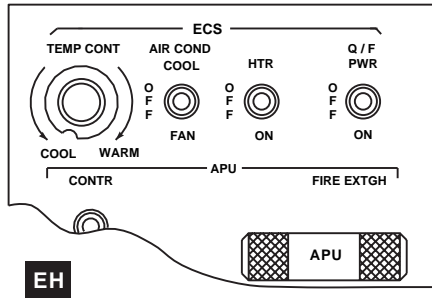

Figure 2-7. Upper Console (Sheet 1 of 2)

AA0364_1A
SA



(ON HELICOPTERS EQUIPPED WITH HEATED CENTER WINDSHIELD)

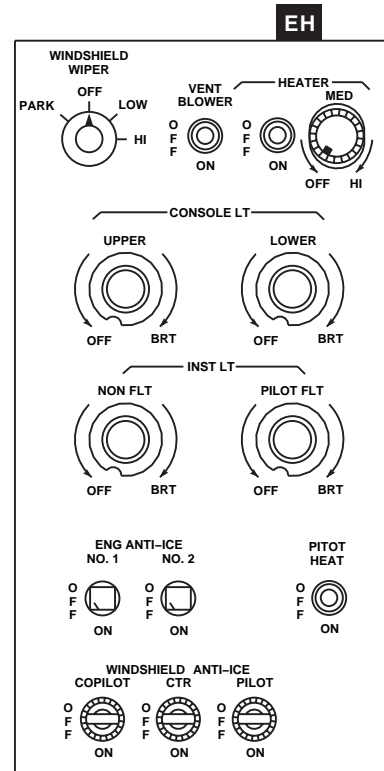

Figure 2-7. Upper Console (Sheet 2 of 2)

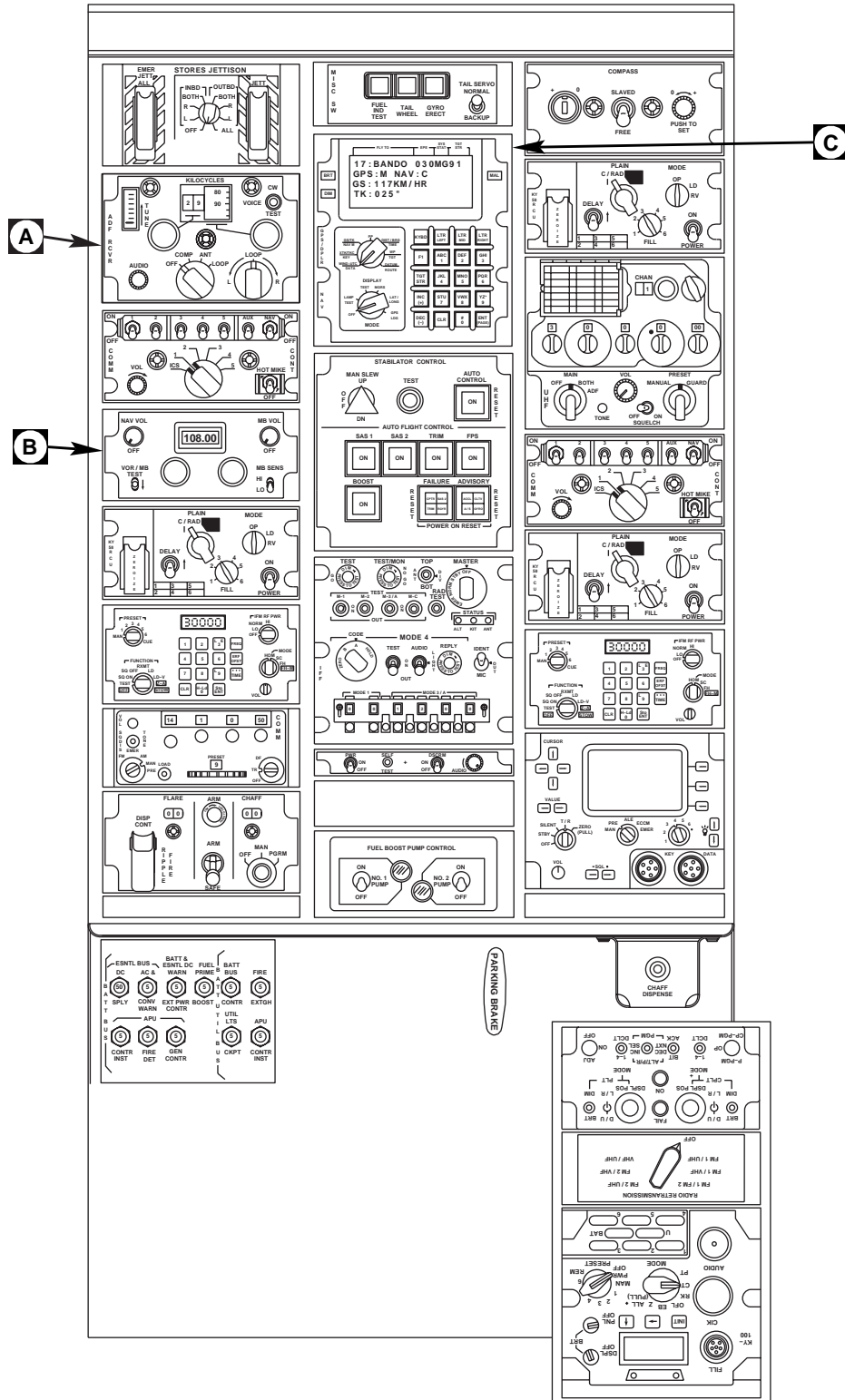
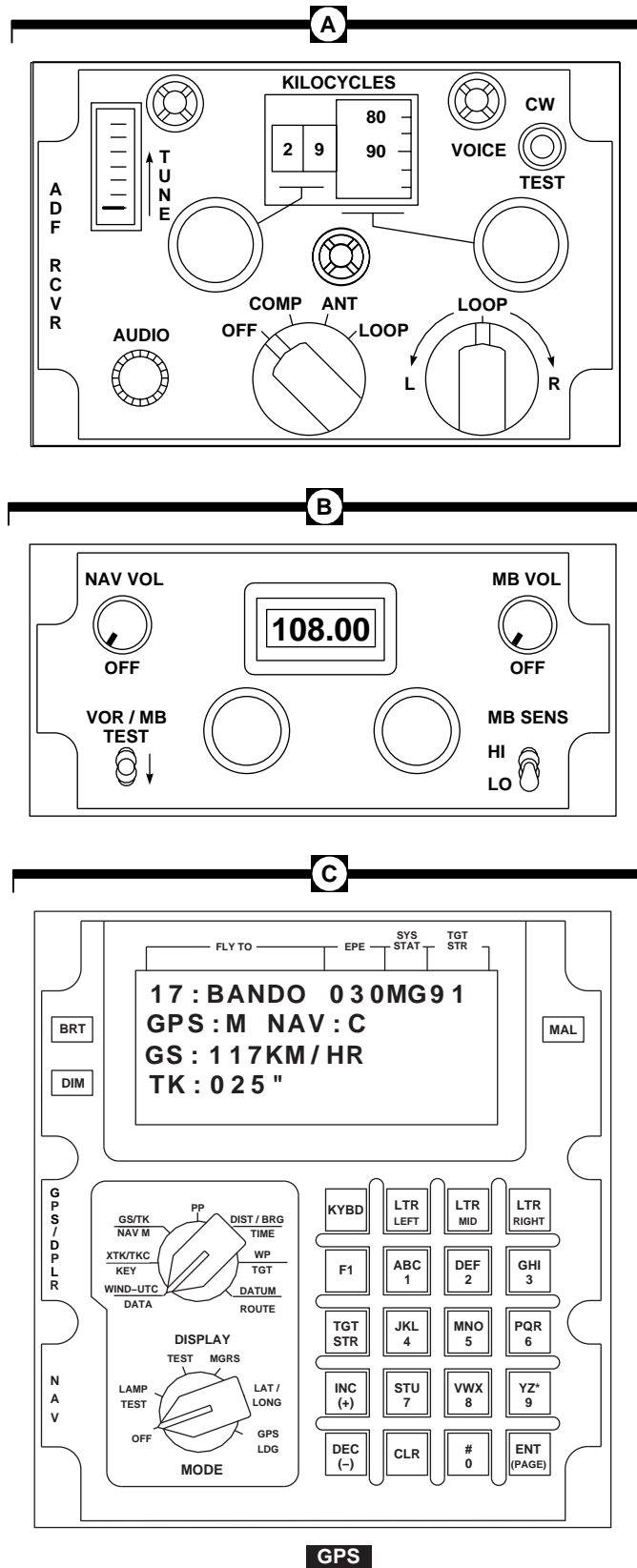

Figure 2-8. Lower Console (Sheet 1 of 3) UH

AA0385_1D
SA



AA0385_2C
SA

Figure 2-8. Lower Console (Sheet 2 of 3) UH

2.11 DOORS AND WINDOWS.

2.11.1 Cockpit Doors. The crew compartment is reached through two doors, one on each side of the cockpit. The doors swing outward and are hinged on the forward side (Figure 2-1). Each door has a window for ventilation. Installed on the back of each door is a latch handle to allow unlatching the door from either inside or outside the cockpit. Emergency release handles are on the inside frame of each door (Figure 9-1). They allow the cockpit doors to be jettisoned in case of an emergency. There is an emergency release pull tab on the inside forward portion of each cockpit door window for pilot egress.

2.11.2 Troop/Cargo (Cabin) Doors. Aft sliding doors are on each side of the troop/cargo compartment (Figure

2-1). Single-action door latches allow the doors to be latched in the fully open or fully closed positions. Each of the two doors incorporate two jettisonable windows, for emergency exit (Figure 9-1).

2.11.3 Crew Chief/Gunner Windows. The Crew Chief/Gunner Stations have forward sliding hatch windows, split vertically into two panels (Figure 2-1). A spring-loaded security latch is installed on each gunner's aft window, to prevent the window opening from the outside. The dead bolt lock requires activation of the security latch lever from inside the helicopter. Another window latch bar is actuated to allow the forward window to be moved to a

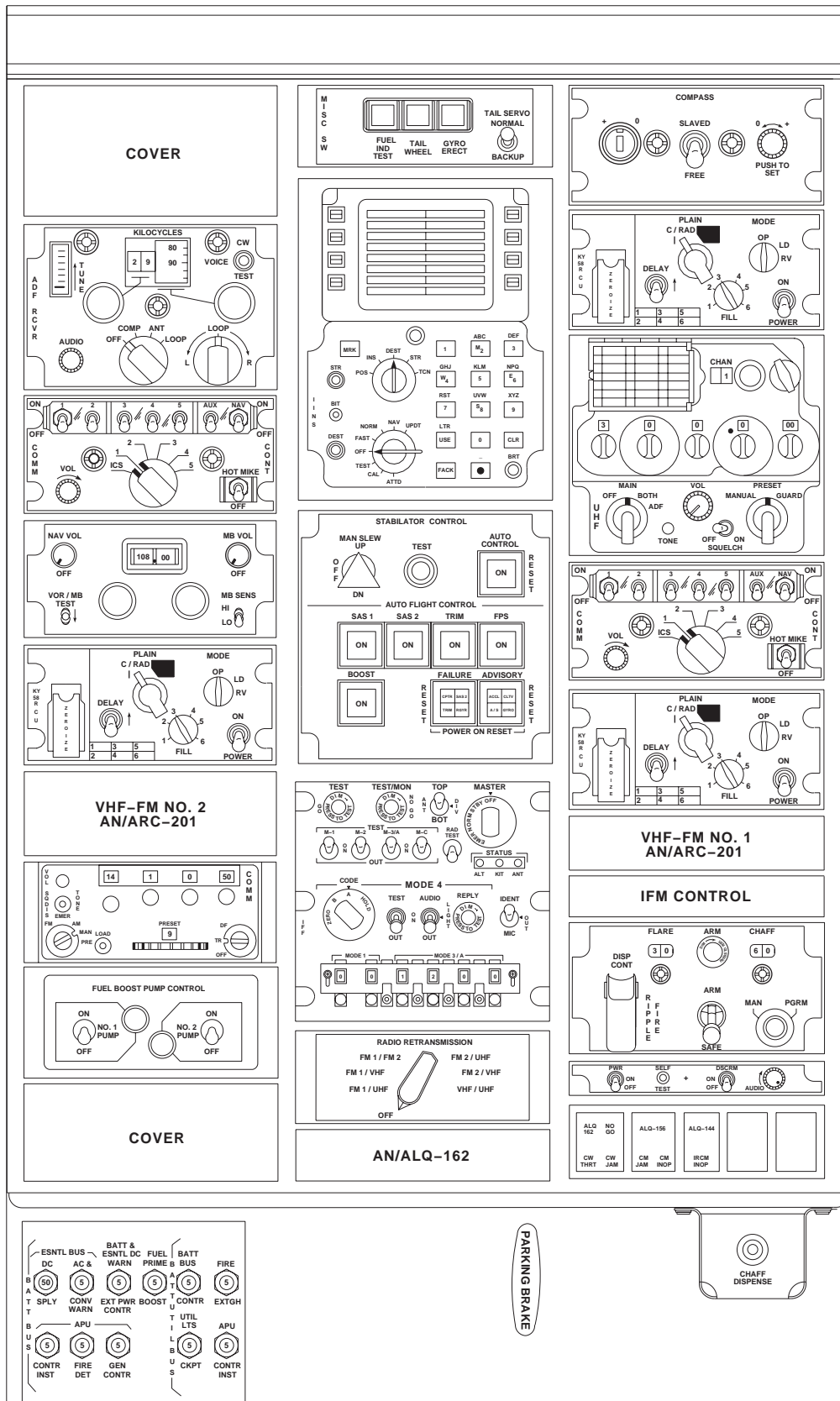
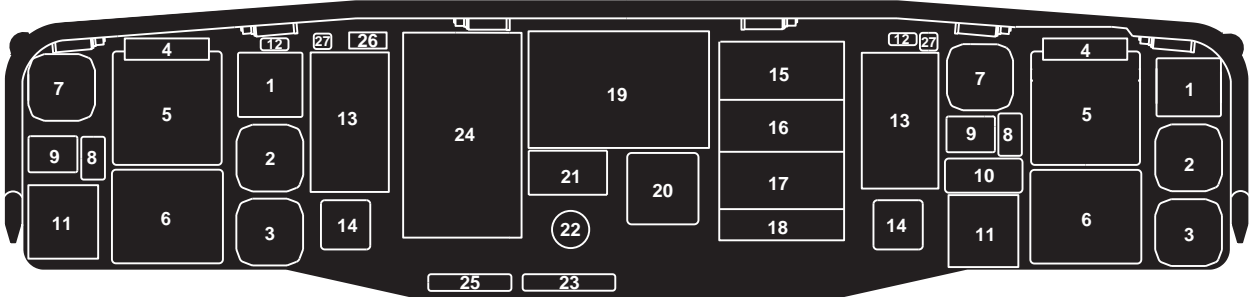
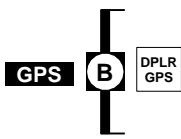
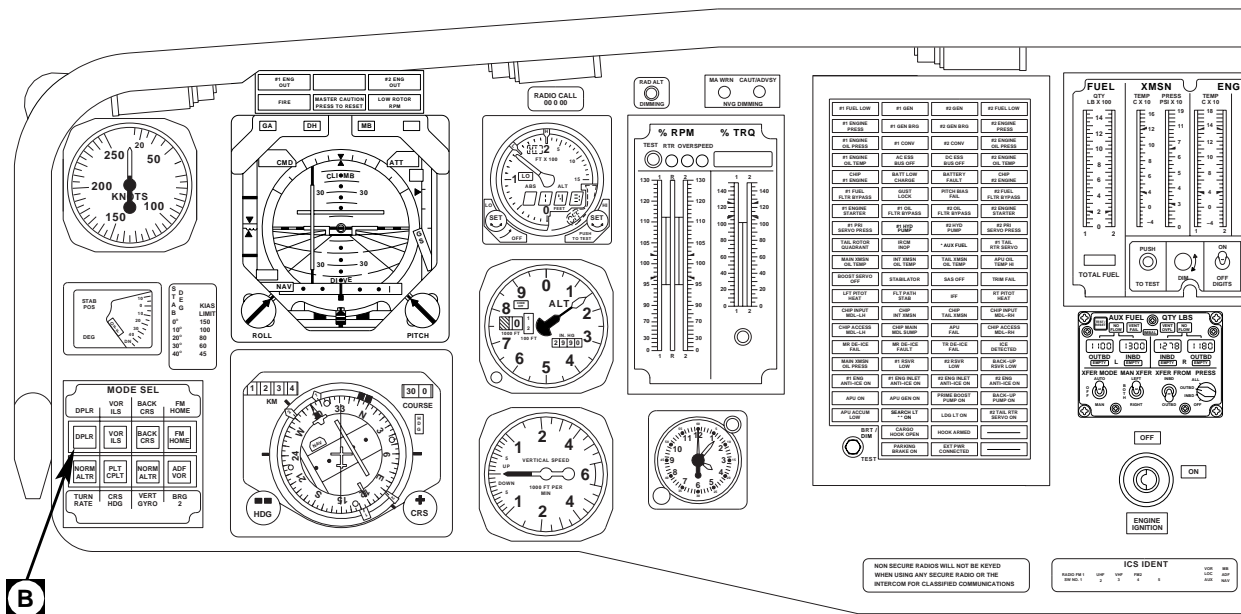

Figure 2-8. Lower Console (Sheet 3 of 3) EH

AA1304_2B SA



NON SECURE RADIOS WILL NOT BE KEPT WHEN USING ANY SECURE RADIO ON THE INTERCOM FOR CLASSIFIED COMMUNICATIONS

ICS IDENT

Figure 2-9. Instrument Panel (Sheet 1 of 4) UH

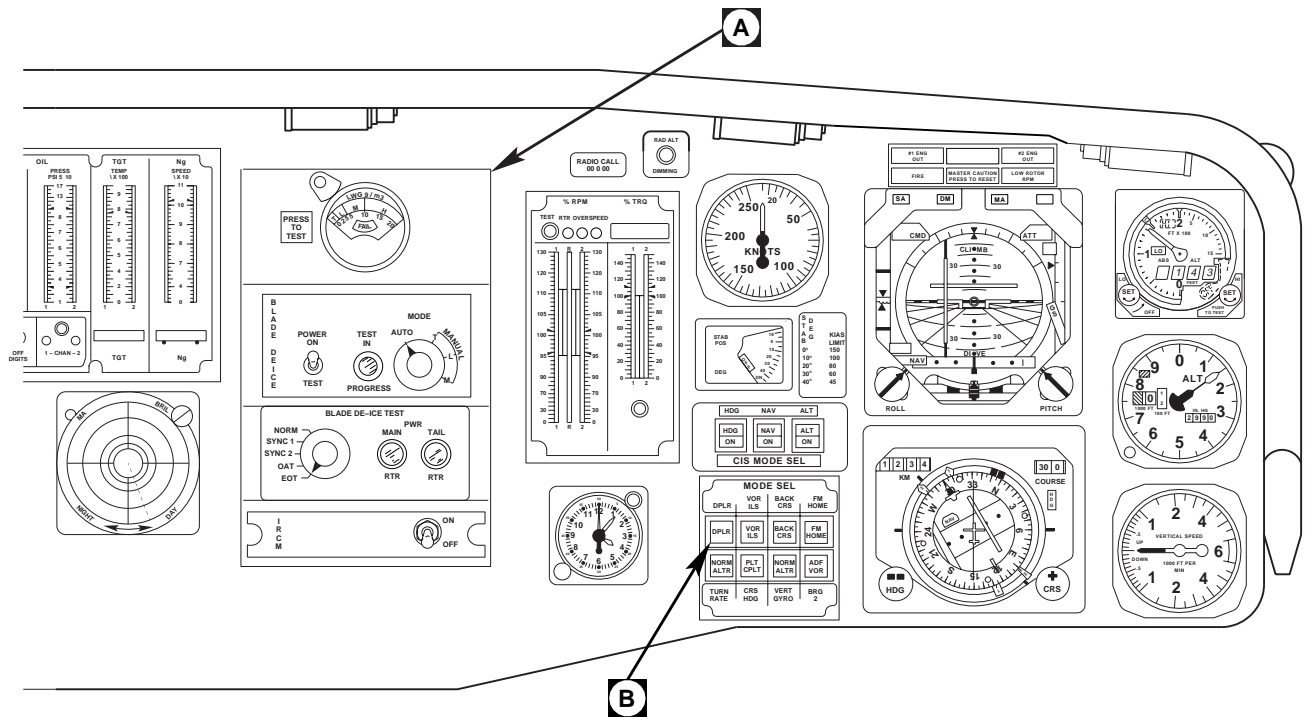

DPLR GPS **B** GPS

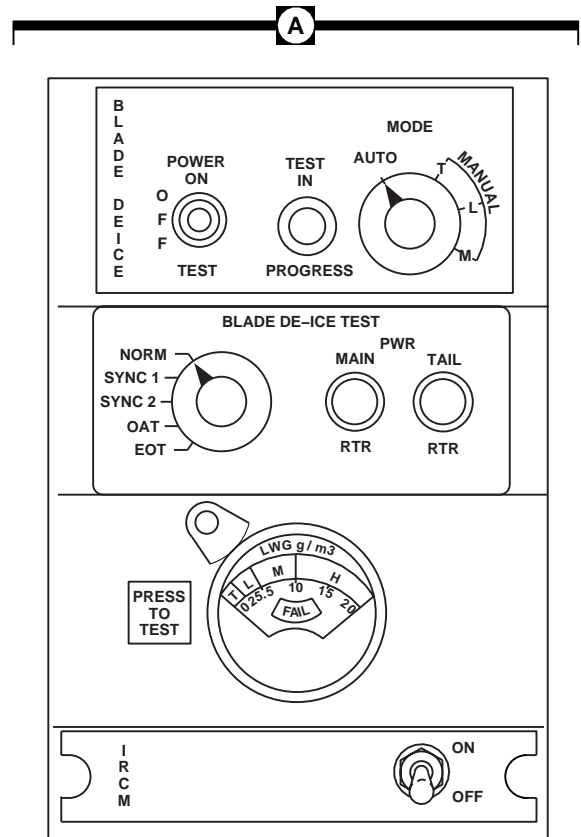

(ON HELICOPTERS WITH REARRANGED BLADE DEICE PANELS)

1. RADAR ALTIMETER
2. BAROMETRIC ALTIMETER
3. VERTICAL SPEED INDICATOR
4. MASTER WARNING PANEL
5. VERTICAL SITUATION INDICATOR
6. HORIZONTAL SITUATION INDICATOR
7. AIRSPEED INDICATOR
8. STABILATOR POSITION PLACARD
9. STABILATOR INDICATOR
10. CIS MODE SELECTOR
11. VSI / HSI MODE SELECTOR
12. RADIO CALL PLACARD
13. PILOT'S DISPLAY UNIT
14. CLOCK
15. ICE RATE METER
16. BLADE DEICE CONTROL PANEL
17. BLADE DEICE TEST PANEL
18. INFRARED COUNTERMEASURE CONTROL PANEL
19. CENTRAL DISPLAY UNIT
20. RADAR WARNING INDICATOR
21. AUXILIARY FUEL MANAGEMENT PANEL **AFMS**
22. ENGINE IGNITION SWITCH
23. RADIO SELECT PLACARD
24. CAUTION / ADVISORY PANEL
25. SECURE WARNING PLACARD
26. NVG DIMMING CONTROL PANEL
27. RAD ALT DIMMING

Figure 2-9. Instrument Panel (Sheet 2 of 4) **UH**

AB0824 SA

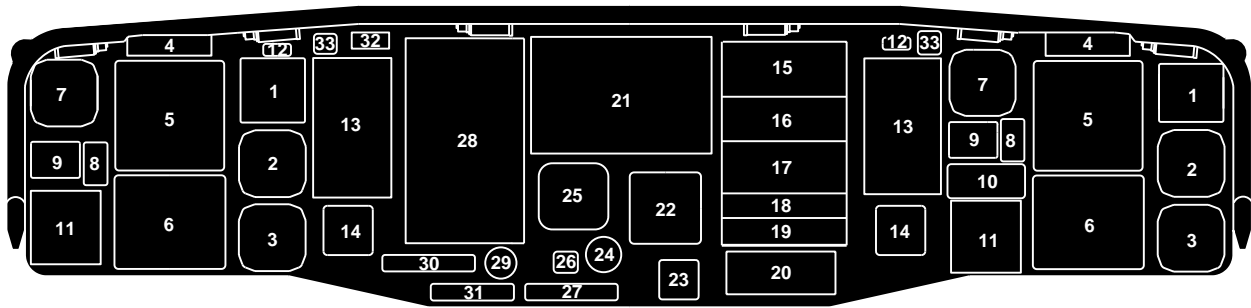
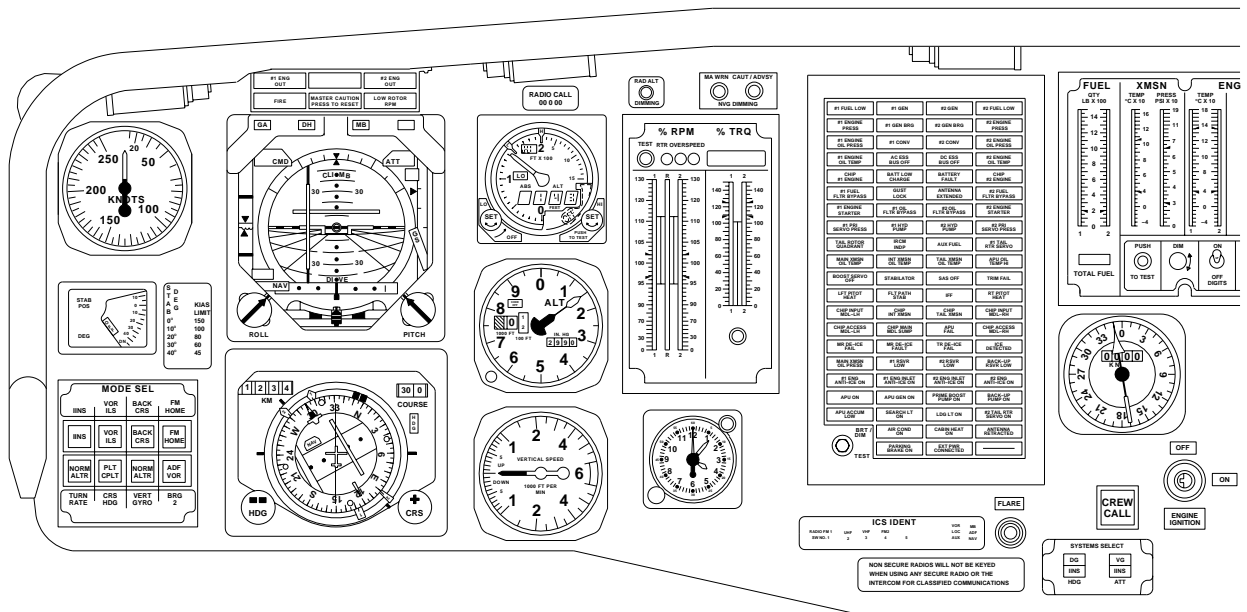
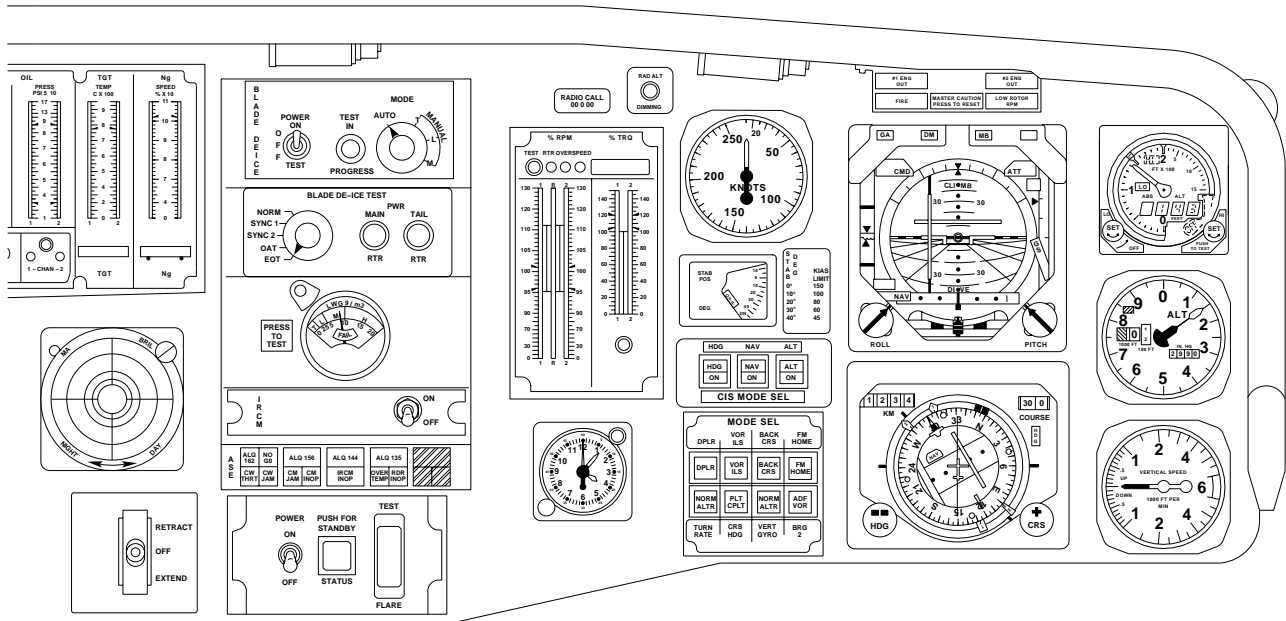

Figure 2-9. Instrument Panel (Sheet 3 of 4) EH



1. RADAR ALTIMETER
2. BAROMETRIC ALTIMETER
3. VERTICAL SPEED INDICATOR
4. MASTER WARNING PANEL
5. VERTICAL SITUATION INDICATOR
6. HORIZONTAL SITUATION INDICATOR
7. AIRSPEED INDICATOR
8. STABILATOR POSITION PLACARD
9. STABILATOR POSITION INDICATOR
10. CIS MODE SELECTOR
11. VSI / HSI MODE SELECTOR
12. RADIO CALL PLACARD
13. PILOT'S DISPLAY UNIT
14. CLOCK
15. BLADE DEICE CONTROL PANEL
16. BLADE DEICE TEST PANEL
17. ICE RATE METER

18. ALQ-144 INFRARED COUNTERMEASURE CONTROL PANEL
19. ASE STATUS PANEL
20. ALQ-156 COUNTERMEASURE PANEL
21. CENTRAL DISPLAY UNIT
22. RADAR WARNING INDICATOR
23. ECM ANTENNA SWITCH
24. ENGINE IGNITION SWITCH
25. BEARING DISTANCE HEADING INDICATOR
26. CREW CALL SWITCH / INDICATOR
27. SYSTEM SELECT PANEL
28. CAUTION / ADVISORY PANEL
29. FLARE DISPENSE SWITCH
30. RADIO SELECT PLACARD
31. SECURE RADIO WARNING PLACARD
32. NVG DIMMING CONTROL PANEL
33. RADAR ALTIMETER DIMMING

Figure 2-9. Instrument Panel (Sheet 4 of 4) EH

stowed position. The windows may be opened to move a machine gun into position for firing.

2.11.4 Door Locks. Key door locks are installed on each of the cabin, cockpit and avionics compartment doors. A common key is used to lock and unlock the doors from the outside to secure the helicopter. Each crew chief/gunner sliding window is locked from the inside only.

2.12 CREW SEATS.

2.12.1 Pilots' Seats.



Do not store any items below seats. Seats stroke downward during a crash and any obstruction will increase the probability and severity of injury.

The pilots' seats provide ballistic protection and can be adjusted for the pilots' leg length and height. The pilot's seat is on the right side, and the copilot's is on the left. Each seat has a one-piece ceramic composite bucket attached to energy absorption tubes. Each seat is positioned on a track with the bucket directly above a recess in the cockpit floor. Crash loads are reduced by allowing the seat and occupant to move vertically as single unit. Occupant restraint is provided by a shoulder harness, lap belts, and a crotch belt.



To prevent injury to personnel, do not release either the normal or emergency vertical adjust levers unless someone is sitting in the seat. The extension springs are under load at all times. With seat at lowest position, the vertical preload on the seat could be as high as 150 pounds. If no one is in the seat and vertical adjust lever(s) is released, the seat will be snapped to the highest stop. Anyone leaning over the seat or with hands on guide tubes above linear bearings, will be seriously injured.

a. Seat Height Adjustment. Vertical seat adjustment is controlled by a lever on the right front of the seat bucket. Springs are installed to counterbalance the weight of the seat. The lever returns to the locked position when released.

b. Forward and Rear Adjustment. The seat is adjusted for leg length by a locking lever on the left front of the seat bucket. The lever is spring-loaded and returns to the locked position when released.

c. Emergency Tilt Levers. The emergency tilt release levers are on each side of the seat support frame. The seat may be tilted back into the cabin for removal or treatment of a wounded pilot. Seat tilting can be done from the cabin, only with the seat in the full down and aft position by pushing in on the tilt handles, and pulling the seat top rearward.

d. Emergency Vertical Release Lever. The emergency vertical release permits the seat to drop to the lowest adjustment point for tilting. The release lever is on the upper center back of the seat, and is actuated by pulling right on the lever.

e. Seat Belts. The pilot's and copilot's seats each contain a shoulder harness, seat belt, and a crotch strap connected to a common buckle assembly. All belts and straps have adjustment fittings. The attachment buckle has a single-point release that will be common in configuration on the pilots and copilots seats; they may be of the lift lever or rotary release configuration, when the lanyard is pulled or the release is turned all belts and straps will release simultaneously.

2.12.2 Protective Armor. Armor protection is provided for the body of the pilot and copilot against 7.62 mm rounds from the side and from the back and below. Armored wings, attached to the cockpit interior, consist of a sliding panel at the outboard side of each seat. A release lever at the front of each panel permits sliding the panel aft to allow rapid entrance and exit, as well as freedom of movement for the seat occupant.

2.12.3 Crew Chief/Gunner Seats.



Do not store any items below seats. During a crash any obstruction will increase the probability and severity of injury.

Two outward facing seats (Figure 2-10), one on each side of the helicopter at the front of the cabin, are for the crew chief/gunners. Each seat faces a window. Each seat is a cable-supported steel tube assembly with a fire-resistant, high strength fabric seat and backrest. Each seat contains two lower energy attenuators designed and oriented to reduce personal injury in a crash. Each seat has a complete

lap belt and dual torso-restraint shoulder harness attached to a dual action rotary release buckle. The shoulder harness is connected to inertia reels on the seat back and bottom. This gives the wearer freedom to move about his station. On helicopters equipped with improved crewchief/gunner's restraint system, the restraint system is equipped with a single action rotary release buckle with a guard. A release plate must be pressed to allow rotation of release, preventing inadvertent handle rotation from contact with equipment etc. The inertia reel lock control is replaced by a shorter push/pull manual locking control. Push in and the inertia reel is manually locked in place. When the control is pulled out, the reel will lock on sudden pull.

WARNING

Do not store any items below seats. During a crash any obstruction will increase the probability and severity of injury.

UH In addition to crew chief and gunner seats, troop seats may be installed for 13 persons. Each troop seat has a belt and shoulder harness for body restraint. The backs and seat pans are attached through cables to the cabin ceiling and through cables and rods to seat fittings installed in the floor. The seats may be installed in any quantity from 1 to

13. Each seat contains two lower energy attenuators designed and oriented to reduce personnel injury. In Row 1, where a forward facing troop seat can be installed, attenuators small end is up and toward right of aircraft. When seats are removed from the cabin and stowed in the storage compartment, adjustments must be made for weight and balance using data in Figures 6-3 and 6-12.

2.13.1 Troop Seat Belt Operation. **UH**

1. Extend shoulder strap and attach shoulder strap fittings to buckle.
2. Extend lap belt and place across body.
3. Place lap belt fitting into buckle and make certain of positive lock.
4. Adjust lap belt tension adjustments and shoulder strap adjustments for a comfortable fit.

2.13.2 DF and ECM Operator's Seats. **EH** The seats are similar to the pilot's and copilot's seats except that armored wing protection is not provided.

2.13.3 Observer's Seat. **EH** The observer's seat is identical to a troop seat (Figure 2-6). It is installed behind, and to the right, of the DF operator's seat.

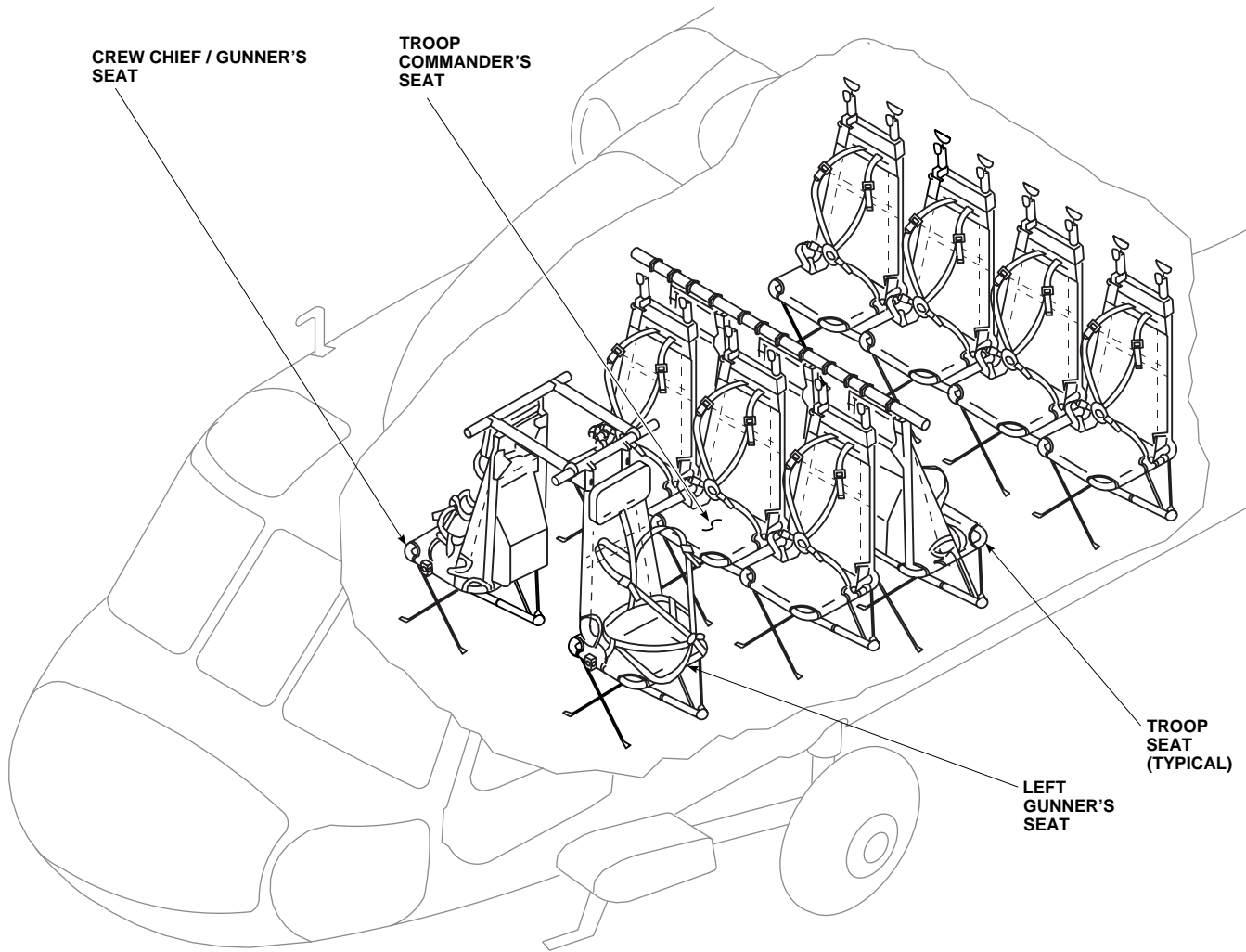

AA0407
SA

Figure 2-10. Troop Seats UH

Section II EMERGENCY EQUIPMENT

2.14 FIRE PROTECTION SYSTEMS.

Fire detection and fire extinguishing systems are installed so that a fire may be detected and put out at either engine or the APU installation, without affecting the remaining two. The engines and APU are monitored by infrared radiation type sensing units, and protected by a main and reserve high-rate discharge type fire extinguisher installation.

2.14.1 Fire Detection System. A detection system provides fire warning to the cockpit in case of fire in either main engine compartment or in the APU compartment. The system consists of five radiation-sensing flame detectors, control amplifiers, and a test panel. Two detectors are installed in each main engine compartment and one detector is in the APU compartment (Figure 2-1). The flame detectors are solid-state photoconductive cells providing continuous volume optical surveillance of the monitored areas. In case of fire, the detectors react to the infrared radiation and send a signal to one of the three control amplifiers which in turn signals the fire warning assembly lighting the proper T-handle (Figures 2-7 and 2-13). Also, the master **FIRE** warning lights will go on if a fire is detected (Figure 2-9). The detector system automatically resets itself, with warning lights off, when the infrared radiation source ceases to emit.

2.14.2 Fire Detector Test Panel. A test switch on the **FIRE DETR TEST** panel on the upper console (Figure 2-7), when moved to positions **1** or **2**, sends a test signal through the system to put on the fire warning lights and verify proper system operation to, but not including, the photo cells. The **No. 1 TEST** position lights **# 1** and **# 2 ENG EMER OFF** T-handles and APU T-handle and checks all firewall mounted detectors. The **No. 2 TEST** position lights **# 1** and **# 2 ENG EMER OFF** T-handle only, and checks all deck mounted detectors. The engines and APU are completely enclosed within their own firewall compartment, thus reducing the possibility of a false fire warning from outside sources. Electrical power to operate the No. 1 and No. 2 detector system is by the dc essential bus through circuit breakers marked **FIRE DET**, **NO. 1 ENG** and **NO. 2 ENG**, respectively. Power to operate the APU detector system is by the battery bus through a circuit breaker marked **APU FIRE DET**.

2.14.3 Fire Extinguishing Systems. A high-rate discharge extinguishing system provides a two-shot, main and reserve capability to either main engine compartment or APU compartment. Two containers are each filled with liq-

uid and charged with gaseous nitrogen. The containers are mounted above the upper deck, behind the right engine compartment (Figure 2-1). Both containers have dual outlets, each with its own firing mechanism. Each extinguishing agent container has a pressure gage, easily viewed for preflight inspection. The system also has a thermal discharge safety port that will cause a visual indicator on the right side of the fuselage to rupture, indicating that one or both containers are empty. Electrical power to operate the No. 1 main and No. 2 reserve outlet valves is by the No. 2 dc primary bus through a circuit breaker, marked **FIRE EXTGH**. Power to operate the No. 2 main and No. 1 reserve fire bottles outlet port valves and the directional control valve is by the battery utility bus through a circuit breaker on the lower console marked **FIRE EXTGH**.

2.14.4 Fire Extinguisher Arming Levers (T-Handles). One APU T-handle is on the upper console (Figure 2-7) marked **APU**, and two engine fire extinguisher T-handles are on the engine control quadrant, marked **#1 ENG EMER OFF** and **#2 ENG EMER OFF** (Figures 2-4 and 2-13). The handle marked **#1 ENG EMER OFF** is for the No. 1 engine compartment, the handle marked **#2 ENG EMER OFF** is for the No. 2 engine compartment, and APU is for the auxiliary power unit compartment. When a handle is pulled, dc power actuates the fire extinguisher logic module to select the compartment to which the fire extinguisher agent is to be directed, and also energizes the circuit to the fire extinguisher switch. The ends of the handles house fire detector warning lights.

2.14.5 Fire Extinguisher Control Panel.

WARNING

In case of fire when ac electrical power is not applied to the helicopter, the reserve fire extinguisher must be discharged. Fire extinguisher agent cannot be discharged into No. 2 engine compartment if ac electrical power is not applied to helicopter.

The switch, marked **FIRE EXTGH**, on the upper console (Figure 2-7), has marked positions **RESERVE-OFF-MAIN**. The switch is operative only after one of the **ENG EMER OFF** or **APU** lever (T-handle) has been pulled. When the switch is placed to **MAIN**, after an **ENG EMER OFF** lever has been pulled, the contents of the main fire extinguisher bottle are discharged into the corresponding

compartment. When the **FIRE EXTGH** switch is placed to **RESERVE** after an **ENG EMER OFF** lever has been pulled, the contents of the opposite fire extinguisher bottle are discharged into the selected compartment. The contents of the fire extinguisher bottle discharge into the compartment of the last lever pulled.

2.14.6 Crash-Actuated System. A crash-actuated system is part of the fire extinguisher system. An omnidirectional inertia switch is hard-mounted to the airframe to sense crash forces. Upon impact of a crash of 10 Gs or more, the switch will automatically fire both fire extinguishing containers into both engine compartments. Electrical power is supplied from the battery utility bus through a circuit breaker on the lower console, marked **FIRE EXTGH**.

2.14.7 Hand-Operated Fire Extinguishers.



Exposure to high concentrations of extinguishing agent or decomposition products should be avoided. The liquid should not be allowed to contact the skin; it could cause frostbite or low temperature burns.

a. **UH** One hand-operated fire extinguisher (Figure 9-1) is mounted on the cabin wall left of the gunner's seat. A second fire extinguisher is on the copilot's seat.

b. **EH** Four hand operated portable fire extinguishers are installed. One mounted on the right gunner window, one on the left pilot seat, one on the DF operator seat, and one on the ECM operator seat. The extinguishers are held in place by a quick-release spring.

2.15 CRASH AXE.

UH One axe (Figure 9-1) is installed between the pilots' seats in the cabin.

2.16 FIRST AID KITS.

a. **UH** Three first aid kits (Figure 9-1) are installed, two on the back of the left pilot seat and one on the back of the right pilot seat.

b. **EH** Five first aid kits are installed. One on the back of the right pilot seat, two on the back of the left pilot seat, one on the back of the DF operator seat, and one on the back of the ECM operator seat.

Section III ENGINES AND RELATED SYSTEMS

2.17 ENGINE.

The T700 engine (Figure 2-11), is a front drive, turboshaft engine of modular construction. One is mounted on the airframe at either side of the main transmission. The engine is divided into four modules: cold section, hot section, power turbine section, and accessory section.

2.17.1 Cold Section Module. The cold section module (Figure 2-11), includes the inlet particle separator, the compressor, the output shaft assembly, and line replaceable units (LRUs). The inlet particle separator removes sand, dust, and other foreign material from the engine inlet air. Engine inlet air passes through the swirl vanes, spinning the air and throwing dirt out by inertial action into the collector scroll, after which it is sucked through by the engine-driven blower and discharged overboard around the engine exhaust duct. The compressor has five axial stages and one centrifugal stage. There are variable inlet guide vanes and variable stage 1 and stage 2 vanes. LRUs mounted on the cold section module are the electrical control unit (ECU) **700**, or digital electronic control (DEC) **701C**, anti-icing and start bleed valve, history recorder **700**, or history counter **701C**, ignition system, and electrical cables.

2.17.2 Hot Section Module. The hot section module (Figure 2-11) consists of three subassemblies; the gas generator turbine, stage 1 nozzle assembly, and combustion liner. LRUs on the hot section module are ignitors **701C** and primer nozzles and ignitors **700**. The gas generator turbine consists of a gas generator stator assembly and a two-stage air cooled turbine rotor assembly which drives the compressor and the accessory gear box. Stage 1 nozzle assembly contains air cooled nozzle segments. The nozzle assemblies direct gas flow to the gas generator turbine. The combustion liner is a ring type combustor cooled by air flow from the diffuser case.

2.17.3 Power Turbine Section Module. The power turbine module (Figure 2-11), includes a two stage power turbine, exhaust frame, and the shaft and C-sump assembly. The LRUs mounted on the power turbine section module are the thermocouple harness, torque and overspeed sensor, and Np (% RPM 1 or 2) sensor.

2.17.4 Accessory Section Module. The accessory section module (Figure 2-11) includes the top mounted accessory gear box and a number of LRUs. The LRUs mounted on the module are the hydromechanical unit (HMU), engine driven boost pump, oil filter, oil cooler, alternator, oil and scavenge pump, particle separator

blower, fuel filter assembly, chip detector, oil filter bypass sensor, radial drive shaft, fuel pressure sensor, and oil pressure sensor.

2.18 ENGINE FUEL SUPPLY SYSTEM.

The engine fuel supply system consists primarily of the low pressure engine driven boost pump, fuel filter, fuel filter bypass valve, fuel pressure sensor, hydromechanical unit (HMU), pressurizing and overspeed unit (POU) **700**, or overspeed and drain valve (ODV) **701C**.

2.18.1 Engine Driven Boost Pump. A low pressure suction engine driven boost pump is installed on the front face of the engine accessory gear box (Figure 2-11). It assures that the airframe fuel supply system is under negative pressure, lessening the potential of fire in case of fuel system damage. Lighting of the **#1** or **#2 FUEL PRESS** caution light at idle speed and above could indicate a leak, or failed engine driven boost pump.

2.18.2 Fuel Filter. The fuel filter is a barrier type full flow filter with integral bypass. An electrical switch lights the caution panel **#1 FUEL FLTR BYPASS** or **#2 FUEL FLTR BYPASS** caution light to indicate filter bypass. In addition, a red button on the filter housing pops out when filter element differential pressure indicates impending bypass. Power for the fuel filter bypass lights is from the No. 1 and No. 2 dc primary busses through circuit breakers marked **NO. 1** and **NO. 2 ENG WARN LTS** respectively.

2.18.3 Fuel Pressure Warning System. The engine fuel pressure warning system for each engine consists of a pressure switch that turns on the **FUEL PRESS** caution light. Fuel pressure caution lights, marked **#1 FUEL PRESS** and **#2 FUEL PRESS** will light when fuel pressure drops below 9 psi. This light can go on when fuel pressure drops, due to failure of the low pressure boost pump or an air leak in the suction fuel system. The effect will vary depending upon the size of the leak. The effect will be more serious at low engine power. A large enough leak may cause a flameout. Power for the No. 1 engine fuel pressure warning system is supplied by the No. 1 dc primary bus through the **NO. 1 ENG WARN LTS** circuit breaker. Power for the No. 2 engine fuel pressure warning system is supplied by the No. 2 dc primary bus through the **NO. 2 ENG WARN LTS** circuit breaker.

2.18.4 Engine Fuel System Components. Control of fuel to the combustion system is done by the HMU. The HMU, mounted on the rear center of the accessory gear box

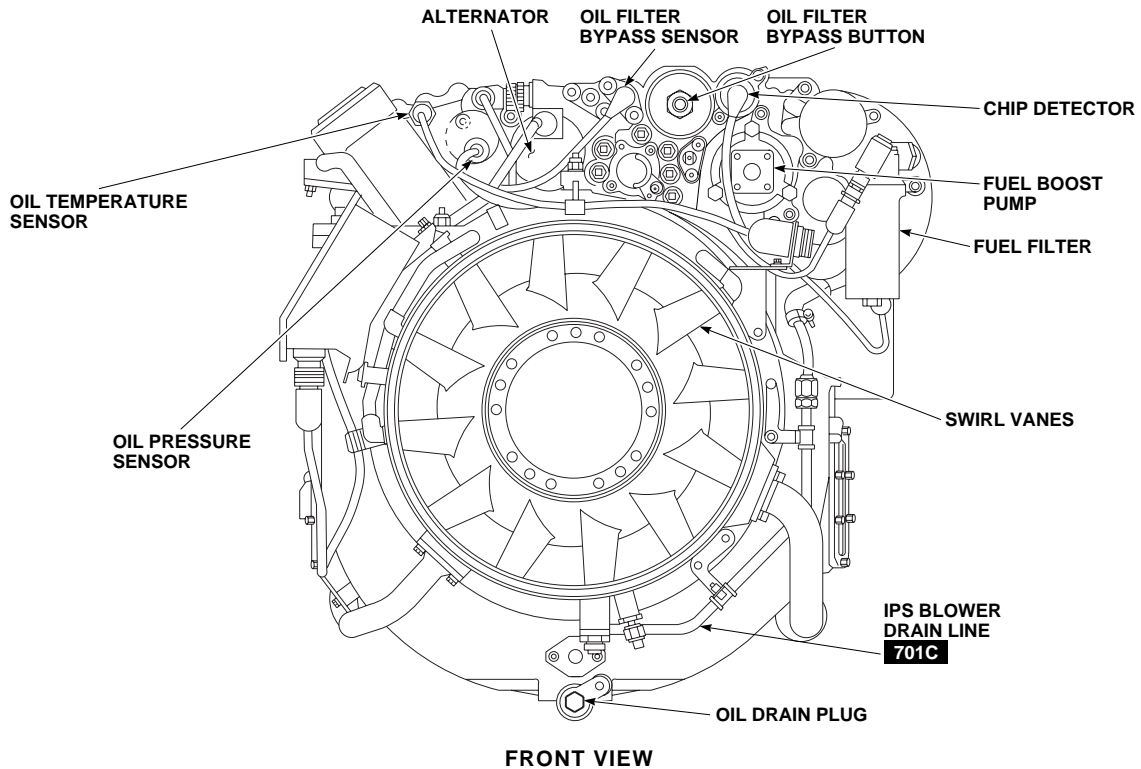
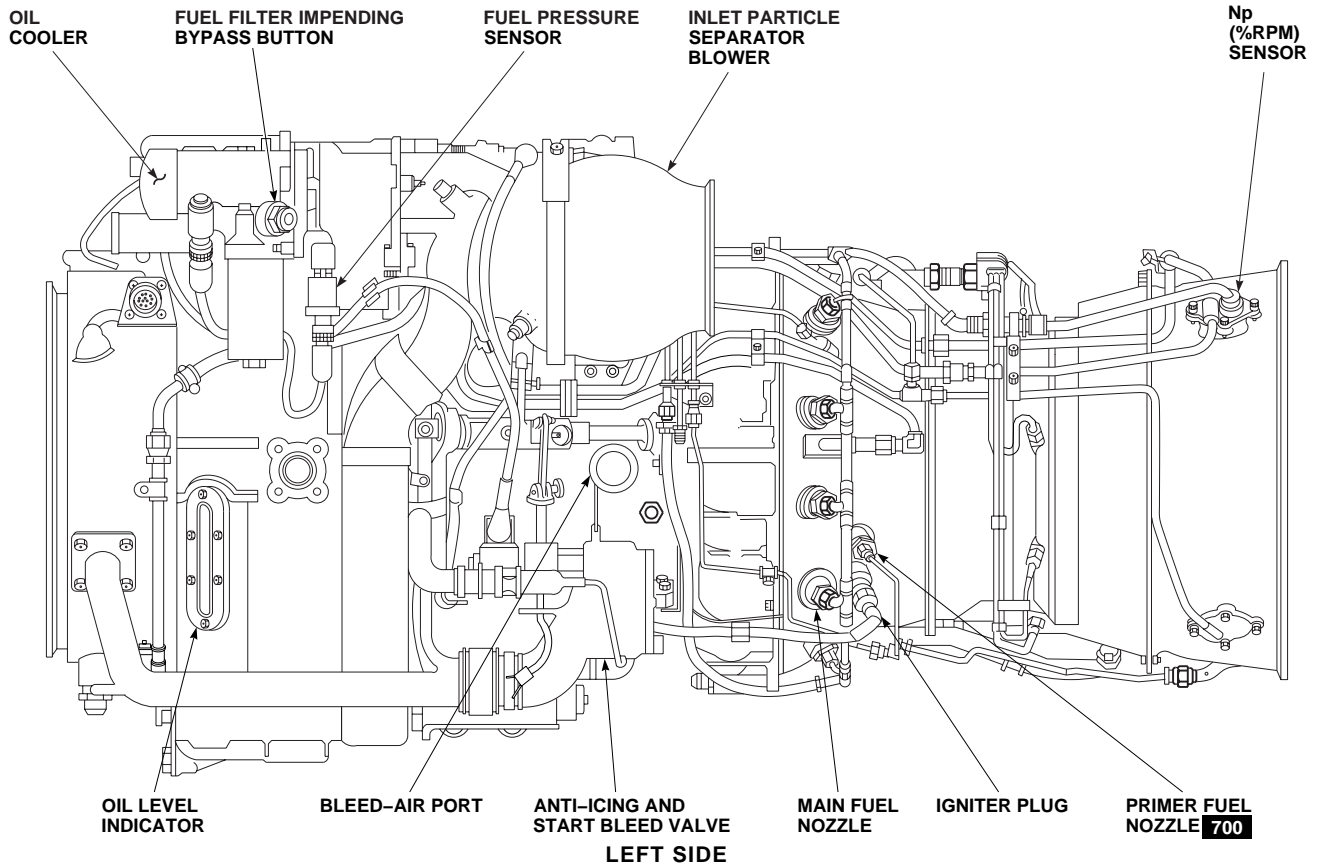

AA0350_1A
SA

Figure 2-11. Engine T700 (Sheet 1 of 2)

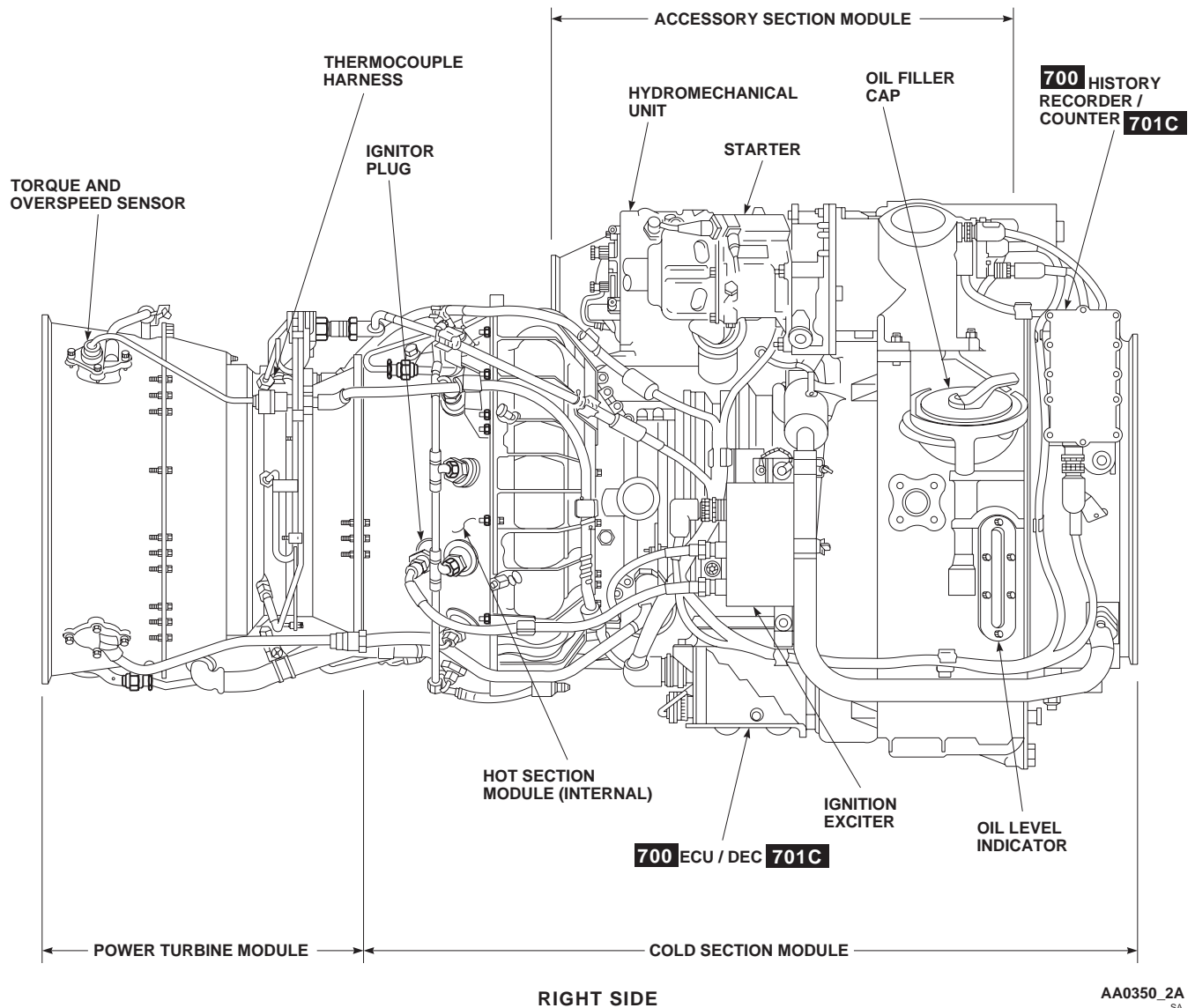

Figure 2-11. Engine T700 (Sheet 2 of 2)

(Figure 2-11), contains a high pressure pump that delivers fuel to the POU/ODV. Various parameters are sensed by the HMU and influence fuel flow, variable geometry position, and engine anti-ice start bleed valve operation. Fuel from the HMU flows to a POU **700** or ODV **701C**.

2.18.4.1 Pressurizing and Overspeed Unit.

700 The POU sends some of the fuel through the fuel start manifold tube to the primer nozzles and allows back flow of high pressure air for purging. The rest of the fuel is sent through the main fuel manifold to the injectors for starting acceleration and engine operation. It purges fuel from the primer nozzles after light off. It purges fuel from the primer

nozzle and main fuel manifold on shutdown. It also reduces fuel flow to prevent an engine overspeed when the overspeed system is tripped as sensed by the ECU.

2.18.4.2 Overspeed and Drain Valve. 701C

The ODV sends fuel through the main fuel manifold to the injectors for starting acceleration and engine operations. It purges fuel from the main fuel manifold and allows back flow of high pressure air for purging. It shuts off fuel flow to prevent an engine overspeed when the overspeed system is tripped as sensed by the DEC. It also shuts off fuel to prevent hot starts when activated by the hot start preventor (HSP).

2.19 ENGINE ALTERNATOR.

2.19.1 Engine Alternator. 700 The engine alternator (Figure 2-11) supplies ac power to the ignition exciter and electrical control unit (ECU). It also supplies a signal to the **Ng SPEED** cockpit indicator. All essential engine electrical functions are powered by the alternator.

a. When the alternator power supply to the ECU is interrupted, a loss of **% RPM 1** or **2** and **% TRQ** indications will occur, with corresponding engine(s) increasing to maximum power (high side).

b. When the alternator Ng signal is interrupted, a loss of Ng cockpit indication will occur with a corresponding **ENG OUT** warning light and audio.

c. A complete loss of engine alternator power results in affected engine(s) increasing to maximum power (high side) with a loss of cockpit indications of **% RPM 1** or **2**, **% TRQ**, and **Ng SPEED**; and an **ENG OUT** warning light and audio will occur. Overspeed protection is still available.

2.19.2 Engine Alternator. 701C The engine alternator (Figure 2-11) supplies ac power to the ignition exciter and digital electronic control (DEC) unit. It also supplies a signal to the **Ng SPEED** cockpit indicator. All essential engine electrical functions are powered by the alternator.

a. When the alternator power supply to the DEC is interrupted, 400 Hz 120 VAC aircraft power is utilized to prevent engine (high side) failure. There will be a loss of the associated cockpit Ng indication and activation of an **ENG OUT** warning light and audio. Overspeed protection is still available.

b. When the alternator Ng signal is interrupted, a loss of the associated engine Ng indication, and an **ENG OUT** warning light and audio will occur. Because the DEC can utilize 400 Hz 120 VAC aircraft power, there will be no loss of associated **% RPM 1** or **2** and **% TRQ** indications.

2.20 IGNITION SYSTEM.

The engine ignition system is a noncontinuous ac powered, capacitor discharge, low voltage system. It includes a dual exciter, two igniter plugs, ignition leads, and **ENGINE IGNITION** keylock switch.

2.21 HISTORY RECORDER. 700

The engine history recorder is mounted on the right side of the swirl frame (Figure 2-11). It displays four digital counters which records information for maintenance purposes only. The history recorder will only operate with an ECU.

2.22 HISTORY COUNTER. 701C

The engine history counter is mounted on the right side of the swirl frame (Figure 2-11). It displays four digital counters which records information for maintenance purposes only. The history counter will only operate with a DEC.

2.23 THERMOCOUPLE HARNESS.

A seven probe harness measures the temperature of the gases at the power turbine inlet. It provides a signal to the ECU **700**, or DEC **701C**, that relays it to the history recorder **700**, or history counter **701C**, through the signal data converter (SDC) to the cockpit temperature gage.

2.24 TORQUE AND OVERSPEED AND % RPM SENSORS.

Two sensors are installed on the exhaust frame of the engine. One sensor provides the power turbine governor and tachometer signal to the ECU **700**, or DEC **701C**. The other sensor feeds the torque computation circuit and overspeed protection system.

2.25 ENGINE BLEED-AIR SYSTEM.

Two bleed-air ports are incorporated on the engine. The outboard port supplies bleed-air to the engine air inlet anti-icing system as described in Section III. The inboard port ties into the pressurized air system. Air from this port is supplied to the cabin heating system and can be supplied to the other engine for crossbleed starts.

2.26 ENGINE ANTI-ICING SYSTEMS.

2.26.1 Engine Anti-Icing.



The engine can incur FOD by improper use of these systems and the other anti-ice/deice systems. For example, ice shedding off the windshield can cause FOD damage to the engines.

a. The engine is anti-iced by two systems; the first described in subparagraph b is called an engine anti-ice system and a second described in paragraph 2.26.2 is called the engine inlet anti-icing. Both of these systems are turned on by the **ENG ANTI-ICE NO. 1** and **NO. 2** switch (Figure 2-7).

b. Engine anti-icing is a combination of bleed-air and heated engine oil. Anti-icing is controlled by a solenoid-operated air valve. The engine anti-ice/start bleed valve opens during starting and will remain open at low power settings until engine reaches 88 to 92% Ng, depending on the outside air temperature, with anti-ice **OFF**. The engine anti-ice/deice system is designed so that in the event of an electrical failure the valve reverts to the anti-icing mode and turns on an advisory light indicating **#1 ENG ANTI-ICE ON** or **#2 ENG ANTI-ICE ON**. Axial compressor discharge air is bled from stage five of the compressor casing, routed through the anti-icing/bleed valve, and delivered to the front frame through ducting. Within the swirl frame, hot air is ducted around the outer casing to each swirl vane splitter lip and inlet guide vanes. The hot air is directed within each vane by a series of baffles. Hot engine oil passing within the scroll vanes in the main frame prevents ice buildup. Water, snow, and solids are carried out through the inlet particle separator discharge system. Switches marked **ENG ANTI-ICE NO. 1** or **NO. 2 OFF**, and **ON**, control engine and inlet anti-ice. At the **ON** position, compressor bleed-air is supplied continuously. Power to operate the anti-icing system is by the No. 1 and No. 2 dc primary buses respectively, through circuit breakers, marked **NO. 1 ENG ANTI-ICE** and **ANTI-ICE WARN**,

NO. 2 ENG ANTI-ICE and **ANTI-ICE WARN** respectively.

2.26.2 Engine Inlet Anti-Icing.

a. The engine air inlets are anti-iced by bleed-air from the engines. Four advisory lights on the caution/advisory panel, marked **#1 ENG ANTI-ICE ON**, **#2 ENG ANTI-ICE ON**, **#1 ENG INLET ANTI-ICE ON** and **#2 ENG INLET ANTI-ICE ON** are provided for the engines. The **#1** and **#2 ENG ANTI-ICE ON** advisory lights will go on when the **ENG ANTI-ICE NO. 1** and **ENG ANTI-ICE NO. 2** switches are placed **ON**. When the anti-ice system is operating and an engine is started, the inlet anti-ice valve for that engine will close. The **#1** and **#2 ENG INLET ANTI-ICE ON** advisory lights operate from temperature sensed at the engine inlet fairing. When the temperature reaches about 93°C (199°F), the temperature switch will turn on the appropriate **ENG INLET ANTI-ICE ON** advisory light. If this light goes on with the switches at **ENG ANTI-ICE NO. 1** and **NO. 2 OFF**, it indicates that heat is being applied to that engine inlet and a malfunction exists. Inlet anti-icing will turn on if dc primary power failure occurs; dc electrical power is applied to keep the valve closed. Functioning of **ENG INLET ANTI-ICE** is controlled as follows:

(1) Above 13°C (55°F) - Illumination of the **ENG INLET ANTI-ICE ON** advisory light indicates a system malfunction.

(2) Above 4°C (39°F) to 13°C (55°F) - The **ENG INLET ANTI-ICE ON** advisory light may illuminate or may not illuminate.

(3) At 4°C (39°F) and below - Failure of **ENG INLET ANTI-ICE ON** advisory light to illuminate indicates a system malfunction. Do not fly the aircraft in known icing conditions.

b. At engine power levels of 10% **TRQ** per engine and below, full inlet anti-ice capability cannot be provided due to engine bleed limitations. Power to operate the valves is normally provided from the No. 1 and No. 2 dc primary buses, respectively, through circuit breakers marked **NO. 1** and **NO. 2 ENG ANTI-ICE**, respectively. During engine start, power to operate the No. 1 engine inlet anti-ice valve is provided from the dc essential bus through a circuit breaker marked **NO. 1 ENG START**. The **#1** and **#2 ENG INLET ANTI-ICE ON** advisory lights receive power from No. 1 and No. 2 dc primary buses, through circuit breakers, marked **NO. 1** and **NO. 2 ENG ANTI-ICE WARN**, respectively.

2.27 ENGINE OIL SYSTEM.

Lubrication of each engine is by a self-contained, pressurized, recirculating, dry sump system. Included are oil and scavenge pump, emergency oil system, monitored oil filter, tank, oil cooler, and seal pressurization and venting. The oil tank is a part of the main frame. Each scavenge line has a screen at the scavenge pump to aid fault isolation. A chip detector with a cockpit warning light is in the line downstream of the scavenge pump.

2.27.1 Engine Emergency Oil System. The engine has an emergency oil system in case oil pressure is lost. Oil reservoirs built into the A and B sumps are kept full during normal operation by the oil pump. Oil bleeds slowly out of those reservoirs and is atomized by air jets, providing continuous oil mist lubrication for the bearings. A **#1 ENGINE OIL PRESS** or **#2 ENGINE OIL PRESS** caution panel light will go on when indicated oil pressure drops below 25 psi on helicopters without modified faceplates on the instrument panel **700**, or below 20 psi on helicopters with modified faceplates **700**, or 22 psi **701C**. Power for the caution lights comes from the No. 1 and No. 2 dc primary buses through circuit breakers marked **NO. 1** and **NO. 2 ENG WARN LTS** respectively.

2.27.2 Oil Tank. The oil tank is an integral part of the engine. Tank capacity is 7 US quarts. The filler port is on the right. Oil level is indicated by a sight gage on each side of the tank. Servicing of the tank is required if the oil level reaches the **ADD** line. Overservicing is not possible because extra oil will flow out the filler port. The scavenge pump returns oil from the sumps to the oil tank through six scavenge screens, each one labeled for fault isolation.

2.27.3 Oil Cooler and Filter. The oil cooler (Figure 2-11) cools scavenge oil before it returns to the tank. Oil from the chip detector passes through the oil cooler and is cooled by transferring heat from the oil to fuel. After passing through the oil cooler, oil enters the top of the main frame where it flows through the scroll vanes. This further cools the oil and heats the vanes for full-time anti-icing. The vanes discharge oil into the oil tank. If the oil cooler pressure becomes too high, a relief valve will open to dump scavenge oil directly into the oil tank. Oil discharged from the oil pump is routed to a disposable-element filter. As the pressure differential across the filter increases, the first indicator will be a popped impending bypass button. As the pressure increases further, this indication will be followed by an indication in the cockpit **#1** or **#2 OIL FLTR BY-PASS**, after which a filter bypass will occur. Power for the caution lights is from the No. 1 and No. 2 dc primary buses respectively, through circuit breakers marked **NO. 1** and **NO. 2 ENG WARN LTS**. During cold weather starting, or

on starting with a partially clogged filter, the high-pressure drop across the filter will cause the bypass valve to open and the caution lights to go on. The impending bypass indicator has a thermal lockout below 38°C to prevent the button from popping. A cold-start relief valve downstream of the filter protects the system by opening and dumping the extra oil to the gear box case.

2.27.4 Engine Chip Detector. The chip detector is on the forward side of the accessory gear box. It consists of a housing with integral magnet and electrical connector, with a removable screen surrounding the magnet. The detector attracts magnetic particles at a primary chip detecting gap. A common oil discharge from the scavenge pump is routed to a chip detector wired to a cockpit caution light marked **CHIP #1 ENGINE** or **CHIP #2 ENGINE**. If chips are detected, a signal is sent to the cockpit to light a caution light, marked **CHIP #1 ENGINE** or **CHIP #2 ENGINE**. Power to operate the engine chip detector system is from the No. 1 and No. 2 dc primary buses respectively, through circuit breakers marked **WARN LTS**, under the general headings **NO. 1 ENG** and **NO. 2 ENG**.

2.28 ENGINE START SYSTEM.

The pneumatic start system uses an air turbine engine start motor for engine starting. System components consist of an engine start motor, start control valve, external start connector, check valves, controls and ducting. Three pneumatic sources may provide air for engine starts: the APU, engine crossbleed, or a ground source. When the start button is pressed, air from the selected source is directed through the start control valve to the engine start motor. The **#1 ENGINE STARTER** or **#2 ENGINE STARTER** caution light will go on at this time and remain on until the starter drops out. As the engine start motor begins to turn, an overrun clutch engages causing the engine to motor. As the engine alternator begins to turn, electrical current is supplied to the ignition exciter. Ignition will continue until either the **ENGINE IGNITION** switch is moved to **OFF** or starter dropout occurs. The **ENG POWER CONT** lever is advanced to **IDLE** detent for light-off and acceleration. A starter speed switch terminates the start cycle when cut-off speed is reached (52% to 65% **Ng SPEED**) and turns off the starter caution light and engine ignition. Malfunction of the starter speed switch may be overcome by manually holding the start button pressed until reaching 52% to 65% **Ng SPEED**. To drop out the starter, manually pull down on the **ENG POWER CONT** lever. To abort a start, pull down on the **ENG POWER CONT** lever and move to **OFF** in one swift movement. Power to operate the No. 1 engine start control valve is from the dc essential bus through a circuit breaker marked **NO. 1 ENG START**. Power to operate the No. 2 engine start control valve is

from the No. 2 dc primary bus through a circuit breaker marked **NO. 2 ENG START CONTR.** For the 701C engine only, fuel flow to the engine will be automatically shut off if **TGT TEMP** exceeds 900°C during the start sequence **701C**.

2.28.1 Engine Ignition Keylock. An **ENGINE IGNITION** keylock is installed on the instrument panel (Figure 2-9), to short out and prevent ignition exciter current flow when the switch is **OFF** and the starter is engaged. The switch is marked **ENGINE IGNITION OFF** and **ON**. When the switch is **ON**, the shorts are removed from both engine alternators, allowing exciter current to flow when the engine alternator begins to turn. The **ENGINE IGNITION** is normally **ON** during flight and turned **OFF** at shutdown. One switch serves both engines. If the switch is **OFF**, neither engine can be started, although motoring capability remains. When an engine is to be motored without a start, make certain the **ENGINE IGNITION** switch is **OFF**. To prevent a possible hot or torching start never turn the **ENGINE IGNITION** switch **ON** after motoring has started. Abort start procedures must be done to remove excess fuel from the engine if a start was attempted with the switch **OFF**.

2.28.2 APU Source Engine Start. The APU provides an on-board source of air and auxiliary electrical power. The APU bleed-air output is enough to start each engine individually at all required combinations of ambient temperatures and enough to start both engines simultaneously within a reduced range of ambient temperatures (Figure 5-5). The **AIR SOURCE HEAT/START** switch must be at **APU**. Refer to Section XII for complete APU description.

2.28.3 Crossbleed Engine Start System. Crossbleed engine starts are used when one engine is operating and it is desired to start the other engine from the bleed-air source of the operating engine. To make a crossbleed start, the operating engine must be at least 90% **Ng SPEED**. When the **AIR SOURCE HEAT/START** switch is placed to **ENG**, both engine crossbleed valves will open. Pressing the start button for the engine not operating will cause the start valve for that engine to open at the same time the crossbleed valve for the starting engine will close, and remain closed until starter dropout occurs. At 52% to 65% **Ng SPEED**, the starting engine start valve will close, stopping bleed-air flow to the starter. Power to operate the bleed shutoff valve is from No. 1 dc primary bus through a circuit breaker marked **AIR SOURCE HEAT/START**.

2.28.4 External Source Engine Start. The external start pneumatic port (Figure 2-1) is on the left side of the fuselage. It is the attachment point for a bleed-air line from

an external source for engine starting or helicopter heating on the ground. The assembly contains a check valve to prevent engine or APU bleed-air from being vented. The external air source pressurizes the start system up to the engine start control valves, requiring only that electrical power be applied. If an emergency start is made without ac electrical power, No. 1 engine must be started first because the No. 2 engine start control valve will not operate without dc primary bus power.

2.29 ENGINE CONTROL SYSTEM.

The engine control system consists of the ECU **700** DEC **701C** engine quadrant, load demand system and speed control system.

2.29.1 Electrical Control Unit (ECU). **700** The electrical control unit controls the electrical functions of the engine and transmits operational information to the cockpit. It is a solid-state device, mounted below the engine compressor casing. The ECU accepts inputs from the alternator, thermocouple harness, Np (% **RPM 1** and **2**) sensor, torque and overspeed sensors, torque signal from opposite engine for load sharing, feedback signals from the HMU for system stabilization, and a demand speed from the engine speed trim button. The ECU provides signals to the % **RPM 1** and **2** indicators, % **TRQ** meter, **TGT TEMP** indicator, and history recorder.

NOTE

Phantom torque may be observed on the Pilot Display Unit (PDU) torque display of a non-operating engine while the aircraft's other engine is operating during a ground run. Phantom torque readings of up to 14% have been observed on the PDU of the non-operating engine. During startup of the non-operating engine, its ECU will produce a normal, positive torque signal which displays the correct torque signal on the respective PDU.

a. In case of an ECU malfunction, the pilot may override the ECU by momentarily advancing the **ENG POWER CONT** lever to the **LOCKOUT** stop, then retarding it to manually control engine power. To remove the ECU from lockout, the **ENG POWER CONT** lever must be moved to **IDLE**.

b. The torque matching/load sharing system increases power on the lower-torque engine to keep engine torques approximately equal. The system does not allow an engine to reduce power to match a lower power engine. If an en-

gine fails to the high side, the good engine will only attempt to increase torque upward until its N_p is 3% above the reference N_p .

c. The temperature limiting system limits fuel flow when the requirement is so great that the turbine temperature reaches the limiting value of 837°C to 849°C. Fuel flow is reduced to hold a constant TGT. It is normal to see a transient increase above the 850°C **TGT TEMP** when the pilot demands maximum power (Figure 5-1 transient limits). TGT limiting does not prevent overtemperature during engine starts, compressor stall, or when the engine is operated in **LOCKOUT** (Paragraph 9.3e).

CAUTION

Delay in release of NO. 1 and NO. 2 ENG OVSP TEST A and TEST B button may result in N_g recycling below idle, resulting in subsequent engine stall and TGT increase. To avoid damage, TGT must be monitored during overspeed check.

d. Overspeed protection protects the power turbine from destructive overspeeds. The system is set to trigger at $106\% \pm 1\%$ **RPM 1** or **2** and will result in an initial reduced fuel flow and will cycle until the cause of the overspeed is removed or % RPM is reduced manually. Two momentary switches marked **NO. 1** and **NO. 2 ENG OVSP TEST A** and **TEST B** on the upper console (Figure 2-7), are used to check the circuits. Testing individual circuits A and B indicates that those systems are complete and performing correctly. Dual closing of A and B serves to check out the actual overspeed system itself, the overspeed solenoid and the POU. This check must be done only on the ground by designated maintenance personnel. The overspeed protection is not deactivated when in **LOCKOUT**. Power to operate the overspeed system is from two independent sources: the engine alternators as the primary source, and the No. 1 and No. 2 ac primary buses as alternate backup source in case of alternator failure. Circuit protection is through circuit breakers marked **NO. 1 ENG OVSP** and **NO. 2 ENG OVSP**.

2.29.2 Digital Electronic Control (DEC).

701C The digital electronic control unit controls the electrical function of the engine and transmits operational information to the cockpit. It contains a microcomputer processor in a conductive composite molded case. The DEC can be fully powered by either the engine alternator or by the 400 Hz, 120 VAC aircraft power. It incorporates logic that will eliminate the torque spike signal during engine start and shutdown.

a. The DEC accepts inputs from the alternator, thermocouple harness, N_p (% **RPM 1** and **2**) sensor, torque and overspeed sensors, RPM R sensor and collective position transducer for improved transient droop response, torque signal from opposite engine for load sharing, feedback signals from the HMU for system stabilization, and the engine speed trim button for N_p demand speed reference.

CAUTION

Delay in release of TEST A/B button may result in N_g recycling below idle, resulting in subsequent engine stall and TGT increase. To avoid damage, TGT must be monitored during overspeed check.

b. The DEC provides signals to the % **RPM 1** and **2** indicators, % **TRQ** meter, **TGT TEMP** indicator, and engine history counter. It also provides signal validations or selected input signals within the electrical control system. Signals are continuously validated when the engine is operating at idle and above. If a failure occurred on a selected input signal, the failed component or related circuit will be identified by a preselected fault code (Figure 2-12) displayed on the engine torque meter. These codes are defined in terms of engine torque. They are displayed for 4 seconds on, 2 seconds off, starting with the lowest code and rotating through all applicable codes, then repeating the cycle. They will only be displayed 30 seconds after both engines are shutdown with 400 Hz, 120 VAC power applied. They may be recalled by maintenance and the engine restarted. The pilot can suppress the fault code display of an engine by depressing the associated cockpit overspeed test button (**TEST A/B**). The pilot may recall it by again depressing the associated cockpit overspeed test button.

c. In case of a DEC malfunction, the pilot may override the DEC by momentarily advancing the **ENG POWER CONT** lever to the **LOCKOUT** stop, then retarding it to manually control engine power. To remove the DEC from lockout, the **ENG POWER CONT** lever must be moved to **IDLE**.

d. The torque matching/load sharing system increases power on the lower-torque engine to keep engine torques approximately equal. The system does not allow an engine to reduce power to match a lower power engine. If an engine fails to the high side, the good engine will only attempt to increase torque upward until its N_p is 3% above the reference N_p .

e. The transient compensation system provides significant droop improvement during some maneuvers by monitoring engine torque, collective rate of change, and RPM R speed rate of change.

f. The temperature limiting system limits fuel flow when the turbine temperature reaches the 10 minute limiting value of 851°C to 878°C. The automatic contingency power limiting will switch the 10 minute temperature limiting to a high single engine temperature limiting value when the opposite engine torque is less than 50%. Fuel flow is regulated to hold a constant TGT. It is normal to see a transient increase above the 903°C **TGT TEMP** limit when the pilot demands maximum power (Figure 5-2 transient limits). TGT limiting does not prevent overtemperature during engine starts, compressor stall, or when the engine is operated in **LOCKOUT** (Paragraph 9.3e).

g. The hot start prevention system (HSP) is a part of the DEC. It prevents overtemperature during engine starts. The

HSP system receives Np, Ng, and TGT signals. When Np and Ng are below their respective hot start reference and **TGT TEMP** exceeds 900°C, an output from the HSP system activates a solenoid in the ODV. This shuts off fuel flow and causes the engine to shut down. The HSP system requires 400 Hz, 120 VAC aircraft power be provided to the DEC. The pilot can disable the HSP for emergency starting purposes by pressing and holding the overspeed test button (**TEST A/B**) for the engine being started during the engine start sequence.

h. Overspeed protection protects the power turbine from destructive overspeeds. The system is set to trigger at $120\% \pm 1\%$ **RPM 1** or **2** and will result in a fuel flow shut-off causing the engine to flame out. When % RPM is reduced below the overspeed limit, fuel flow is returned to the engine and engine ignition will come on to provide a relight. This cycle will continue until the overspeed condition is removed. Two momentary switches marked **NO. 1**

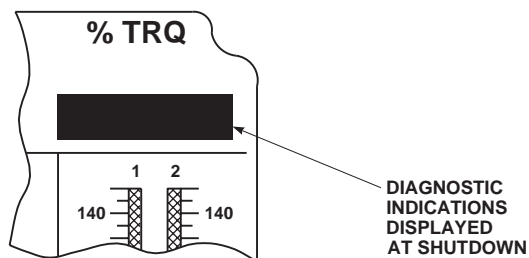

SIGNAL FAILED	DIAGNOSTIC INDICATION ON TORQUE METER (± 3%)
DEC	15%
Np DEMAND CHANNEL	25%
LOAD SHARE CHANNEL	35%
TGT CHANNEL	45%
ALTERNATOR POWER	55%
Ng CHANNEL	65%
Np CHANNEL	75%
TORQUE AND OVERSPEED CHANNEL	85%
HOT START PREVENTION CHANNEL	95%
AIRCRAFT 400 Hz POWER	105%
COLLECTIVE CHANNEL	115%
Nr	125%

AA0517
SA

Figure 2-12. Signal Validation - Fault Codes **701C**

and **NO. 2 ENG OVSP TEST A** and **TEST B** on the upper console (Figure 2-7), are used to check the circuits. Testing individual circuits A and B indicates that those systems are complete and performing correctly. Dual closing of A and B switches serve to check out both the overspeed system, and the overspeed drain valve (ODV). This check must be done only on the ground. The overspeed protection is not deactivated when in **LOCKOUT**. Power to operate the overspeed system is from two independent sources: the engine alternators as the primary source, and the No. 1 and No. 2 ac primary buses as alternate backup source in case of alternator failure. Circuit protection is through circuit breakers marked **NO. 1 ENG OVSP** and **NO. 2 ENG OVSP**.

2.29.3 Engine Control Quadrant. The engine control quadrant (Figure 2-13) consists of two **ENG POWER CONT** levers, two **ENG FUEL SYS** selector levers, and two **ENG EMER OFF** T-handles. A starter button is on each **ENG POWER CONT** lever. Each **ENG POWER CONT** lever has four positions: **OFF-IDLE-FLY-LOCKOUT**. Movement of the **ENG POWER CONT** levers moves a cable to mechanically shut off fuel or set available Ng **SPEED**. The lever is advanced to **FLY** for flight. This **ENG POWER CONT** lever setting represents the highest power that could be supplied if demanded. Power turbine speed (**% RPM 1** or **2**) is not governed until the power lever is advanced from **IDLE**. The engine quadrant secondary stop, two stop blocks, the quadrant assem-

bly, and a latch on each **ENG POWER CONT** lever prevent moving the levers below **IDLE** detent. When shutdown is required, the **ENG POWER CONT** lever must be pulled out slightly, at the same time the latch release must be pressed, then the **ENG POWER CONT** lever can be moved below **IDLE** detent. After being moved momentarily to **LOCKOUT**, the **ENG POWER CONT** lever is used to manually control **Ng SPEED** and **% RPM 1** or **2**. With the **ENG POWER CONT** lever at **LOCKOUT**, the automatic **TGT** limiting system is deactivated and **TGT** must be manually controlled. The overspeed protection system is not deactivated when at **LOCKOUT**.

2.29.4 Load Demand System. With **ENG POWER CONT** lever at **FLY**, the ECU **700** or DEC **701C** and HMU respond to collective signals to automatically control engine speed and provide required power. During emergency operations, when the **ENG POWER CONT** lever is moved to **LOCKOUT** and then to some intermediate position, the engine will still respond to collective signals.

2.29.5 Engine Speed Control System. An engine RPM control switch on the collective grips (Figure 2-14) controls the speed of both engines simultaneously. There is no individual trim capability. It is used to supply a signal to the ECU **700**, or DEC **701C** for controlling **% RPM 1** and **2** as required. The **ENG RPM** control switch allows adjustment between 96% and 100%. The pilot can override the copilot's control. Power for **ENG RPM** control system is from the No. 2 dc primary bus through a circuit breaker marked **SPEED TRIM**.

2.30 HOVER INFRARED SUPPRESSOR SUBSYSTEM (HIRSS).

The hover IR suppressor (Figure 2-2) provides improved helicopter survivability from heat-seeking missiles throughout the flight envelope. The HIRSS kit has no moving parts. It contains a three-stage removable core which reduces metal surface and exhaust gas temperature radiation and prevents line-of-sight viewing of hot engine surfaces. The HIRSS channels hot exhaust gasses through the three-stage core and inner baffle to induce the flow of cooling air from the engine bay and the inlet scoops. The three-stage core and inner baffle cold surfaces are coated with low-reflectance material. For further cooling, hot exhaust gas is ducted outboard and downward by the engine, away from the helicopter by the exhaust deflector, where additional cooling air is provided by the main rotor downwash. Installation of each HIRSS module requires removal of the standard engine exhaust module and aft cabin door track fairings. HIRSS modules are installed on the basic airframe equipped with HIRSS fixed provisions by two airframe mounts. The aft fairings are installed using existing mount-

ing points and hardware. While operating in a non-hostile environment, the inner baffle can be removed to enhance helicopter performance.

2.31 ENGINE INSTRUMENTS.

The instrument displays (Figure 2-9) consist of **ENG OIL TEMP** and **PRESS**, **TGT TEMP**, gas generator **Ng SPEED**, power turbine speed (**% RPM 1** or **2**), rotor speed **% RPM R**, engine torque **% TRQ**, and **FUEL QTY** to provide the pilots with engine and subsystem monitoring. Continuous indications of those parameters are indicated on vertical scales, digital readouts and caution lights. Instruments without low range turn-off feature: **% TRQ**, **TGT TEMP**, **Ng SPEED**, **ENG OIL TEMP** and **XMSN TEMP** will remain on as parameter increases and go out as it decreases (Figure 5-1). Power for lighting the displays is from the No. 1 and No. 2 ac primary and No. 1 and No. 2 dc primary buses through the signal data converters.

2.31.1 Engine Oil Temperature Indicator. Each engine has an oil temperature sensor wired through the signal data converter to a vertical scale instrument, marked **ENG OIL TEMP**, on the central display unit; and to an engine oil temperature caution light, marked **ENGINE OIL TEMP**, on the caution/advisory panel.

2.31.2 Engine Oil Pressure Indicator. Each engine has an engine oil pressure transmitter, downstream of the oil filter, that sends readings to a vertical scale indicator, marked **ENG OIL PRESS**, on the instrument display panel; and to an engine oil pressure caution light, marked **ENGINE OIL PRESS**, on the caution panel. The lower precautionary and prohibited ranges will go out when reaching the bottom of the normal range. **700** It may be possible that during **IDLE** operations, the **ENGINE OIL PRESS** caution light will go on. **700** If **ENGINE OIL PRESS** caution light comes on at **IDLE**, verify oil pressure is acceptable by setting **Ng SPEED** at 90%, check that engine oil pressure is at least 35 psi. As pressure increases above 100 psi **700**, or 120 psi **701C** the respective prohibited scale changes to red.

2.31.3 TGT Temperature Indicator. The **TGT** indicating system consists of thermocouples transmitting to a **TGT TEMP** indicator. The indicator assembly has two digital readouts that indicate precise temperatures.

2.31.4 Gas Generator Speed (Ng) Indicator. The **Ng** speed indicating system shows **Ng** speed for each engine. The system consists of one alternator winding and **Ng SPEED** vertical scale instrument, on the instrument panel,

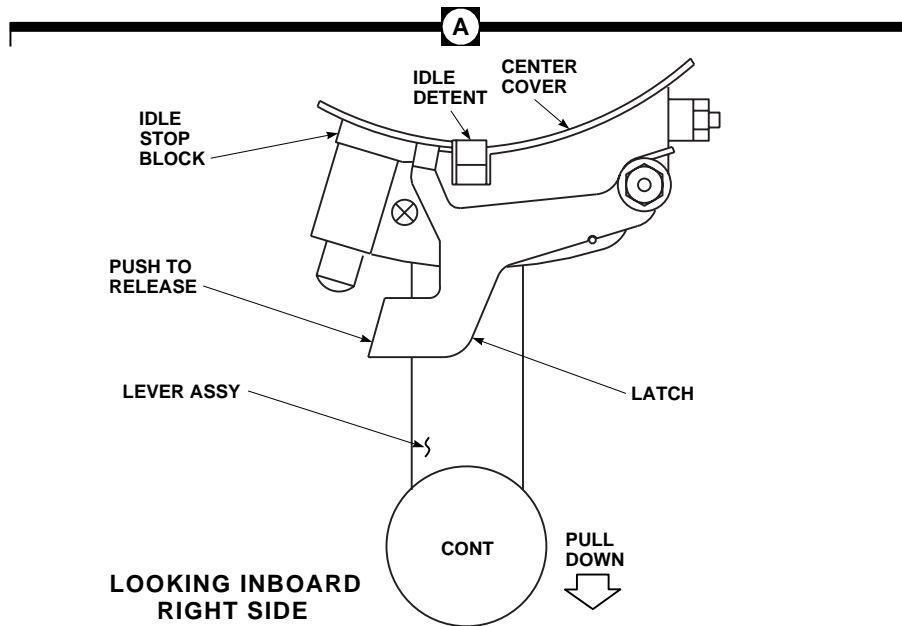
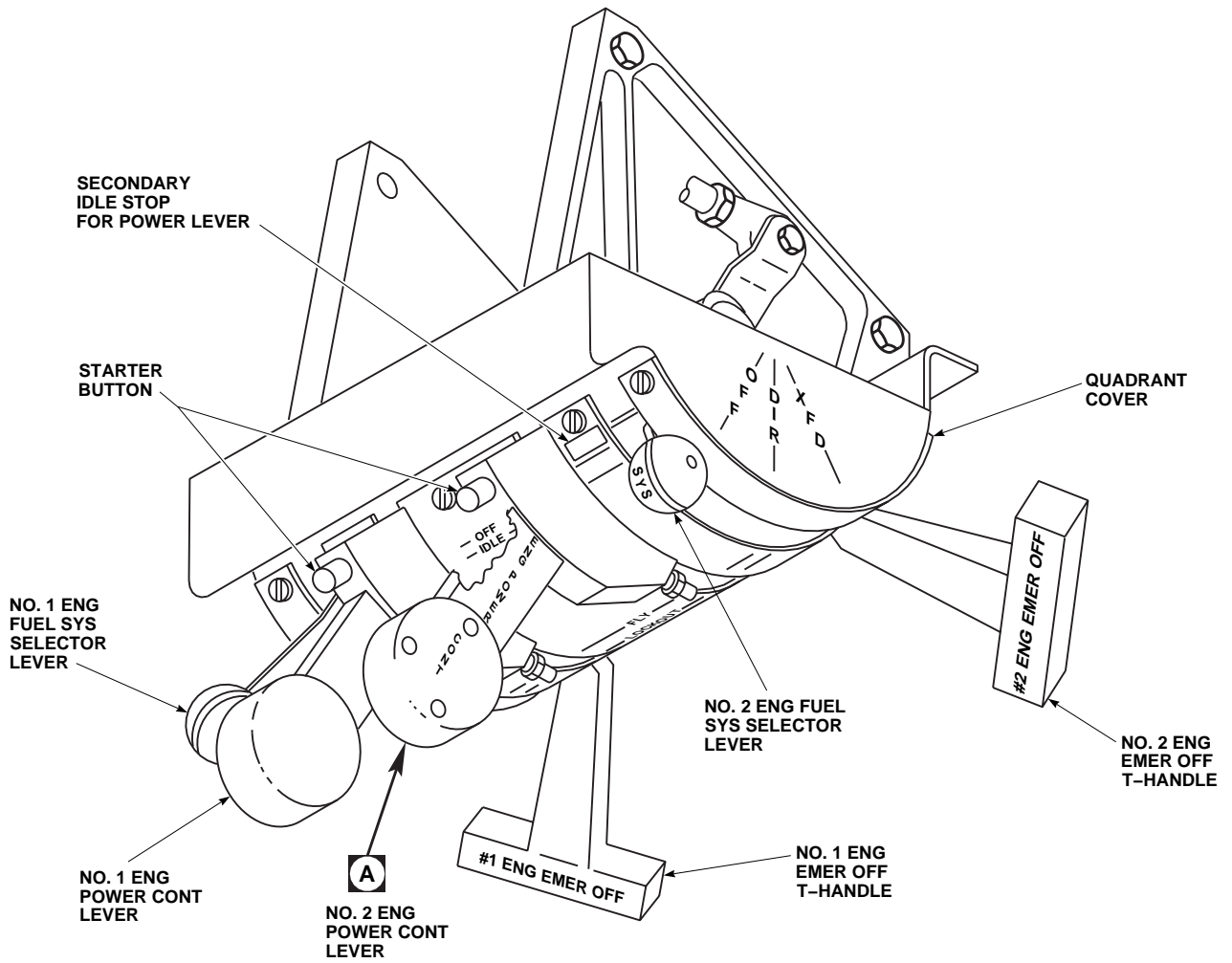

Figure 2-13. Engine Control Quadrant

AA0351A
SA

giving percent rpm. Digital readouts for **Ng SPEED** are at the lower section of the instrument face plate. The three-digit readouts provide a closer indication of **Ng SPEED**.

2.31.5 Engine Power Turbine/Rotor Speed Indicator. Power turbine and rotor speed are indicated for each engine on a single instrument marked **% RPM 1 R 2** on the display panel with three vertical scales (Figure 5-1). Power turbine speed is indicated in **% RPM 1** or **2** and rotor speed **% RPM R**. Rotor speed is sensed by a speed sensor on the right accessory module. Power turbine speed is sensed by a speed sensor on the engine exhaust frame. At the top of the panel are three warning lights that indicate varying degrees of rotor overspeed. These lights remain on, once tripped, and must be manually reset.

2.31.6 Torque Indicator. The torque indicating system shows the amount of power the engine is delivering to the main transmission. A torque sensor mounted on the exhaust case measures the twist of the power turbine shaft, and transmits this signal to the ECU **700**, or DEC **701C** and signal data converter into the torque indicator marked **% TRQ** on the display panel, displaying readings for both engines. Digital readouts giving torques for each engine are at the top of the indicator. A photocell on the lower center of the display will automatically adjust the lighting of the **% RPM** and **% TRQ** indicators with respect to ambient light.

Section IV FUEL SYSTEM

2.32 FUEL SUPPLY SYSTEM.

A separate suction fuel system is provided for each engine. Fuel is stored in two interchangeable, crashworthy, ballistic-resistant tanks. The fuel system consists of lines from the main fuel tanks, firewall-mounted selector valves, prime/boost pump and fuel tanks, and engine-driven suction pumps. The prime/boost pump primes all fuel lines if prime is lost, and also acts as an APU boost for APU starts and operation. A selector valve, driven by cable from the **ENG FUEL SYS** selector lever on the engine control quadrant (Figure 2-13) permits operation of either engine from either fuel tank. The engines and APU are suction fed, the APU is fed from the left main fuel tank by a separate fuel line. All fuel lines are routed in the most direct manner. The fuel line network includes self-sealing breakaway valves that contain fuel in case of helicopter crash or malfunction. All engine fuel lines are self-sealing with the exception of the APU fuel line.

2.32.1 Fuel Tanks. Both main fuel tanks are crashworthy, self-sealing and interchangeable. Each tank contains a pressure refuel/defuel valve, fuel quantity and low-level sensors, high-level shutoff valve, low-level shutoff valve, check valve sump drain, and a self-sealing breakaway vent valve. (Refer to Table 2-4 for tank capacity.) Fuel tank drains are in the sumps to permit removal of sediment and water and provide fuel sampling.

2.32.2 Engine Fuel System Selector Control. Each fuel system has a selector valve which is manually operated through the **ENG FUEL SYS** selector lever on the overhead engine control quadrant (Figure 2-13). There is an **ENG EMER OFF** T-handle on each side of the quadrant which is arranged so that pulling the handle engages the **ENG FUEL SYS** selector lever, bringing it to **OFF**. The **ENG FUEL SYS** selectors are connected to the fuel selector valves with low-friction flexible push-pull cables. Each lever can be actuated to three positions: **OFF**, **DIR**, and **XFD**. With the selectors at **OFF**, the control valves are closed, allowing no fuel flow to the engines. When the selectors are moved forward to **DIR**, the selector valves are opened, providing fuel flow for each engine from its individual fuel tank. If a tank is empty, or you wish to equalize fuel in the tanks, the **ENG FUEL SYS** selector of the en-

gine that normally feeds from the empty or low-level tank is moved to **XFD**. This connects that engine to the other tank through the crossfeed system. A check valve in each crossfeed line prevents air from an inoperative engine's fuel line crossing to the operating one.

2.32.3 Fuel Filter. The engine fuel filter has a bypass valve and bypass warning device. The filter is mounted on the forward left side of the engine accessory gear box. An impending bypass warning is incorporated on the filter housing in the form of a popout button. The bypass valve opens to assure continuous fuel flow with a blocked filter. At the same time the valve opens, an electrical switch closes to light the **#1** or **#2 FUEL FLTR BYPASS** caution light. Power to operate the bypass warning system is from the No. 1 and No. 2 dc primary buses through circuit breakers marked **NO. 1** and **NO. 2 ENG WARN LTS**, respectively.

2.33 ENGINE FUEL PRIME SYSTEM.

NOTE

Priming engines using sump mounted fuel boost pumps is described in paragraph 8.41.3.

A toggle switch on the upper console, marked **FUEL PUMP, FUEL PRIME, OFF** and **APU BOOST** (Figure 2-7), when moved to **FUEL PRIME**, energizes the prime/boost pump and solenoid valves to each main engine fuel supply line and to the solenoid valve for the APU fuel feed system. Advisory panel indication is displayed during this mode by a light marked **PRIME BOOST PUMP ON**. Prime pump capacity is not enough to prime an engine when the opposite engine is running. Engines should therefore be primed individually with both engines off. The prime/boost pump is actuated and the engine prime valve is opened whenever the engine starter is operating. This provides fuel pressure to aid in a successful engine start. When the engine speed reaches starter dropout speed, engine fuel prime valve will close and the prime/boost pump will also stop operating if the **FUEL PUMP** switch is **OFF**. Power to operate the prime boost system is from the battery bus through a circuit breaker marked **FUEL PRIME BOOST**.

2.34 FUEL QUANTITY INDICATING SYSTEM.

All internal fuel is continuously gaged with the **FUEL QTY** gage system (Figure 2-8). The system consists of two tank unit sensors (probes), one in each tank, a dual channel fuel quantity gage conditioner, and a dual channel low-level warning system. The tank units are connected to the fuel quantity gages marked **FUEL QTY 1-2** on the central display panel. A separate total fuel quantity readout numerically displays the total quantity of fuel on board. The system may be checked out by pressing the **FUEL IND TEST** pushbutton on the miscellaneous switch panel. The vertical scales of the **FUEL QTY** indicator and the digital readout should show a change, and the **#1** and **#2 FUEL LOW** caution lights on the caution/advisory panel should flash. When the button is released, the scales and digital readout will return to the original readings. The fuel quantity indicating system is powered by the No. 1 ac primary bus through a circuit breaker, marked **NO. 1 AC INST**.

2.34.1 Fuel Low Caution Light. Two low-level sensors, one on each probe, provide signals which activate two low-level caution lights indicating **#1 FUEL LOW** or **#2 FUEL LOW**. Those lights flash when the fuel level decreases to approximately 172 pounds in each tank. The illumination of these lights does not mean a fixed time period remains before fuel exhaustion, but is an indication that a low fuel condition exists. The fuel-low caution lights are powered by the No. 1 dc primary bus through a circuit breaker marked **FUEL LOW WARN**.

2.34.2 Fuel Boost Pump. The helicopter fuel system contains an electrically-operated submerged fuel boost pump in each fuel tank. When the pumps operate, they provide pressurized fuel to the engine fuel inlet port. Each

boost pump is controlled by a switch on the **FUEL BOOST PUMP CONTROL** panel (Figure 2-8). The two-position switch for each pump, marked **ON-OFF**, activates the pump for continuous operation to maintain a head of fuel pressure at the engine fuel inlet port, regardless of engine boost pump discharge pressure. An advisory light near each control switch indicates pump pressure and operation. A check valve in each pump discharge line prevents fuel recirculation during fuel boost operation, and prevents loss of engine fuel line prime. **#1** or **#2 FUEL PRESS** caution light going on is also an indicator to turn on boost pumps. Power to operate the boost pumps is provided from the No. 1 and No. 2 ac primary buses through circuit breakers marked **NO. 1** and **NO. 2 FUEL BOOST PUMP**, respectively.

2.34.3 Refueling/Defueling. A pressure refueling and defueling system provides complete refueling and defueling of both tanks from one point on the left side of the helicopter (Figure 2-26). Closed circuit refueling uses the pressure refueling system and its components. No electrical power is required for the system during refueling or defueling. The tank full shutoff valve is float-operated. A dual high-level shutoff system acts as back up for each other. The two high-level float valves close, causing a back pressure to the fueling/defueling valve at the bottom of the tank, closing the refuel valve. The tank empty automatic shutoff system is a function of the low-level float valve opening to allow air to be drawn into the line, closing the defuel valve. A filler neck between the fuselage contour and the fuel cell is a frangible (breakaway) connection. Gravity fueling is done through filler neck on each side of the fuselage for the respective tanks. Gravity defueling capability is provided through the drains.

Section V FLIGHT CONTROLS

2.35 FLIGHT CONTROL SYSTEMS.

NOTE

Flight near high power RF emitters such as microwave antennas or shipboard radar may cause uncommanded AFCS and/or stabilator control inputs. Electromagnetic interference (EMI) testing has shown that the master caution light may illuminate before or simultaneously with any uncommanded stabilator trailing edge movement, with 4° or 5° of movement being the maximum.

The primary flight control system consists of the lateral control subsystem, the longitudinal control subsystem, the collective pitch control subsystem, and the directional control subsystem. Control inputs are transferred from the cockpit to the rotor blades by mechanical linkages, and hydraulic servos. Pilot control is assisted by stability augmentation system (SAS), flight path stabilization (FPS), boost servos, and pitch, roll and yaw trim. Dual cockpit controls consist of the cyclic stick, collective stick and pedals. The pilot and copilot controls are routed separately to a combining linkage for each control axis. Outputs from the cockpit controls are carried by mechanical linkage through the pilot-assist servos to the mixing unit. The mixing unit combines, sums, and couples the cyclic, collective, and yaw inputs. It provides proportional output signals, through mechanical linkages, to the main and tail rotor controls.

2.35.1 Cyclic Stick. Lateral and longitudinal control of the helicopter is by movement of the cyclic sticks through push rods, bellcranks, and servos to the main rotor. Movement in any direction tilts the plane of the main rotor blades in the same direction, thereby causing the helicopter to go in that direction. Each cyclic stick grip (Figure 2-14) contains a stick trim switch, marked **STICK TRIM FWD, L, R** and **AFT**, a go around switch, marked **GA**, trim release switch, marked **TRIM REL**, a panel light kill switch, marked **PNL LTS**, a cargo release switch, marked **CARGO REL**, and a transmitter **ICS** switch, marked **RADIO** and **ICS**. Refer to major systems for a complete description of switches on the cyclic grip.

2.35.2 Collective Pitch Control Stick. The collective sticks change the pitch of the main rotor blades, causing an increase or decrease in lift on the entire main rotor disc. A friction control on the pilot's lever can be turned to adjust the amount of friction and prevent the collective stick from creeping. The copilot's stick telescopes by twisting the grip and pushing the stick aft to improve access to his seat. Each

collective stick has a grip (Figure 2-14) with switches and controls for various helicopter systems. These systems are: landing light control, marked **LDG LT PUSH ON/OFF EXT** and **RETR**; searchlight controls, marked **SRCH LT ON/OFF, EXT, L, R**, and **RETR**; servo shutoff control switch, marked **SVO OFF 1ST STG** and **2ND STG**; engine speed trim switch, marked **ENG RPM INCR** and **DECR**; and cargo hook emergency release switch, marked **HOOK EMER REL**; **HUD** control switch, marked **BRT, DIM, MODE**, and **DCLT**. All switches are within easy reach of the left thumb. For a complete description of switches and controls, refer to major system description.

2.35.3 Mixing Unit. A mechanical mixing unit provides control mixing functions which minimizes inherent control coupling. The four types of mechanical mixing and their functions are:

a. Collective to Pitch - Compensates for the effects of changes in rotor downwash on the stabilator caused by collective pitch changes. The mixing unit provides forward input to the main rotor as collective is increased and aft input as collective is decreased.

b. Collective to Yaw - Compensates for changes in torque effect caused by changes in collective position. The mixing unit increases tail rotor pitch as collective is increased and decreases tail rotor pitch as collective is decreased.

c. Collective to Roll - Compensates for the rolling moments and translating tendency caused by changes in tail rotor thrust. The mixing unit provides left lateral input to the main rotor system as collective is increased and right lateral input as collective is decreased.

d. Yaw to Pitch - Compensates for changes in the vertical thrust component of the canted tail rotor as tail rotor pitch is changed. The mixing unit provides aft input to the main rotor system as tail rotor pitch is increased and forward input as tail rotor pitch is decreased.

2.35.4 Collective/Airspeed to Yaw (Electronic Coupling). This mixing is in addition to collective to yaw mechanical mixing. It helps compensate for the torque effect caused by changes in collective position. It has the ability to decrease tail rotor pitch as airspeed increases and the tail rotor and cambered fin become more efficient. As airspeed decreases, the opposite occurs. The SAS/FPS computer commands the yaw trim actuator to change tail rotor pitch as collective position changes. The amount of tail rotor pitch change is proportional to airspeed. Maximum mixing

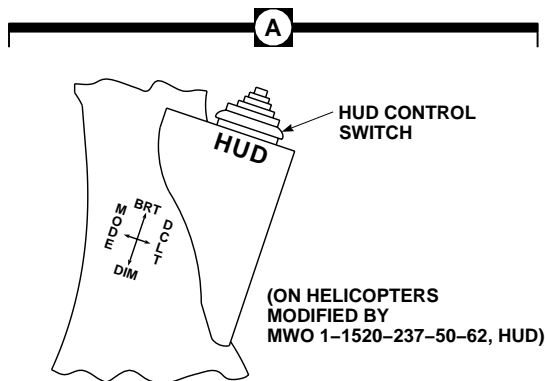
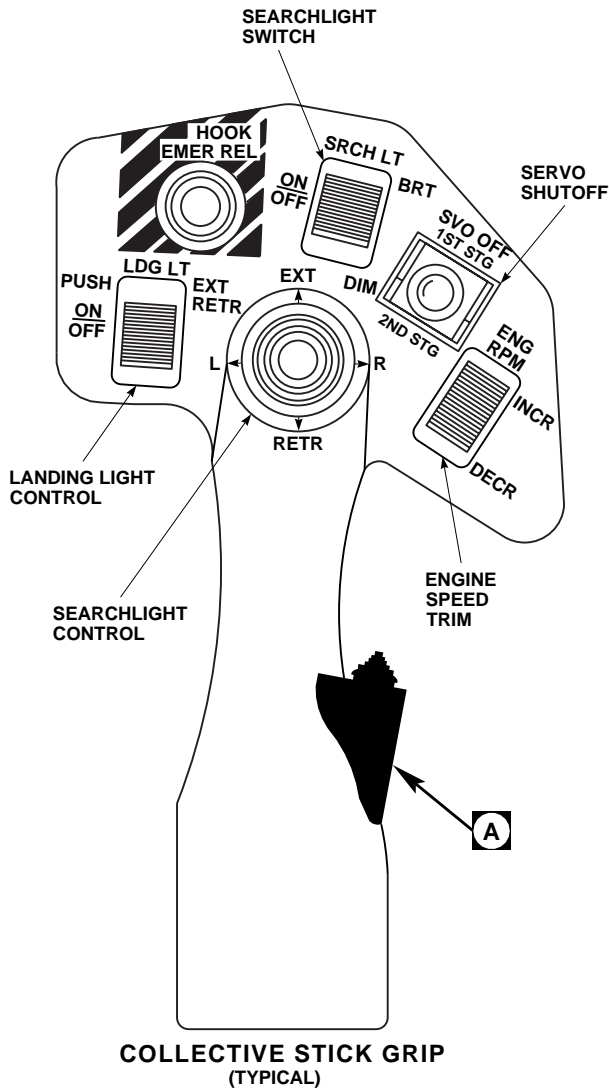

AA0365_1C
SA

Figure 2-14. Collective and Cyclic Grips (Sheet 1 of 2)

occurs from 0 to 40 knots. As airspeed increases above 40 knots, the amount of mixing decreases until 100 knots, after which no mixing occurs.

2.35.5 Tail Rotor Control. The tail rotor control system determines helicopter heading by controlling pitch of the tail rotor blades. Inputs by the pilot or copilot to the control pedals are transmitted through a series of control rods, bellcranks, a mixing unit, control cables and servos to the pitch change beam that changes blade pitch angle. Hydraulic power to the tail rotor servo is supplied from No. 1 or the backup hydraulic systems.

2.35.6 Tail Rotor Pedals. The pedals contain switches that, when pressed, disengage the heading hold feature of FPS below 60 KIAS. Adjustment for pilot leg length is done by pulling a T-handle, on each side of the instrument panel, marked **PED ADJ**. The pedals are spring-loaded and will move toward the operator when unlocked. Applying pressure to both pedals simultaneously will move the pedals for desired leg position. The handle is then released to lock the pedal adjusted position.

2.36 FLIGHT CONTROL SERVO SYSTEMS.

2.36.1 Primary Servos. Main rotor control loads are reacted by three, two-stage primary servos mounted on the upper deck above the cabin, forward of the main gear box. Each primary servo contains two independent, redundant stages with only the mechanical input linkage in common. If one stage becomes inoperative due to pressure loss, a bypass valve within the depressurized stage will open, preventing hydraulic lock. Electrical interlocks prevent both flight control servos from being turned off simultaneously. If the input pilot valve to the servo becomes jammed, bypass automatically occurs. Automatic bypass is indicated to the pilot by lighting of the associated **PRI SERVO PRESS** caution light.

2.36.2 Tail Rotor Servo. Tail rotor control loads are reacted by a two-stage tail rotor servo mounted on the tail gear box. With the **TAIL SERVO** switch at **NORMAL**, the first stage of this servo is powered by the No. 1 hydraulic system. When the **TAIL SERVO** switch is moved to **BACKUP**, the second stage is powered by the backup system. Should the first stage become inoperative, the backup pump will come on and power the second stage. All aerodynamic loads are then reacted by the second stage.

2.36.3 Flight Control Servo Switch. First and second stage primary servo systems are controlled by the servo switch, marked **SVO OFF**, on the pilot's and copilot's collective stick grips (Figure 2-14). The marked switch positions are **1ST STG** and **2ND STG**. The servo systems nor-

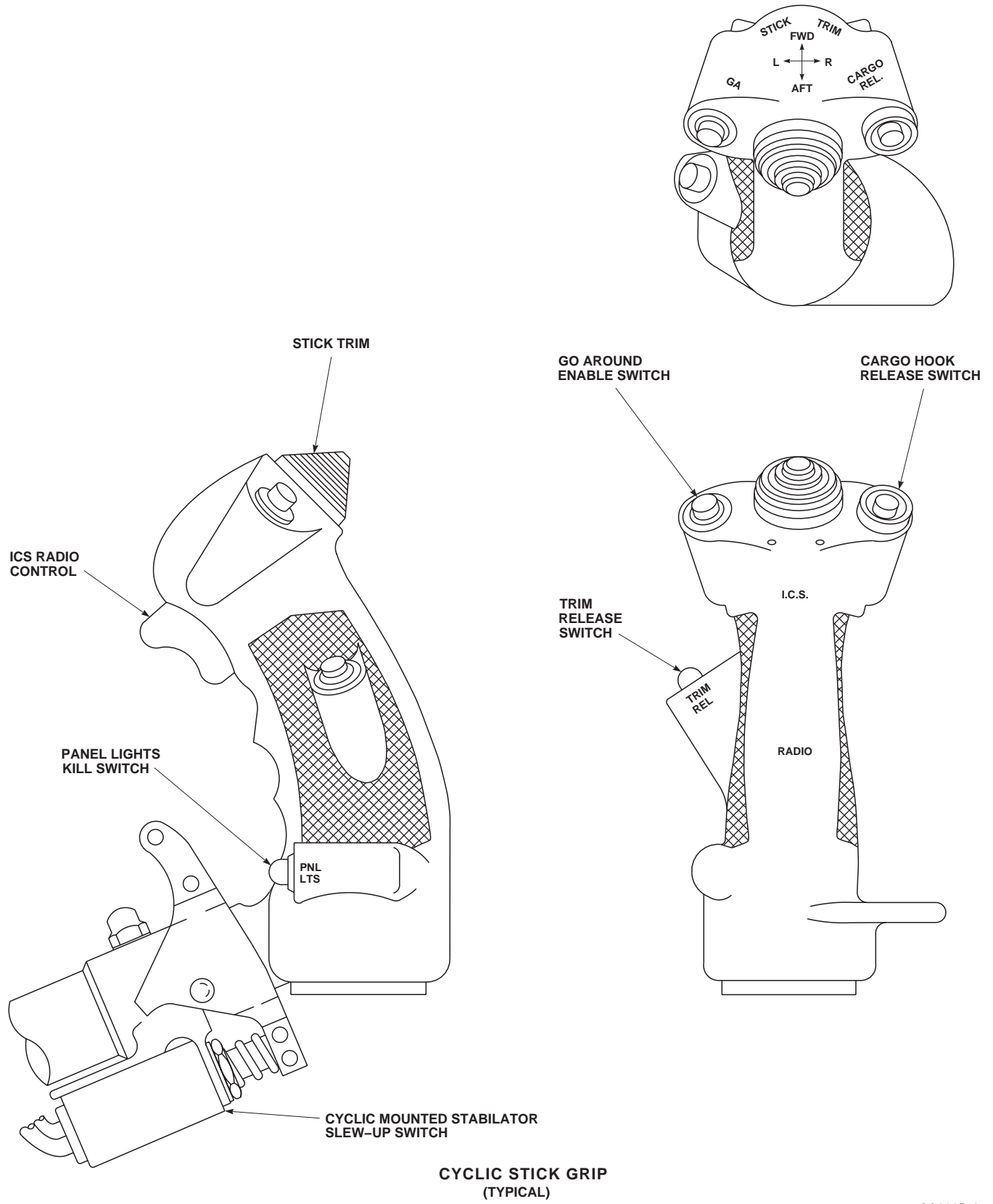

Figure 2-14. Collective and Cyclic Grips (Sheet 2 of 2)

AA0365 2
SA

mally operate with the switch in the unmarked center (on) position. To turn off the first stage primary servos, the **SVO OFF** switch is placed to **1ST STG**. To turn off the second stage servo, the switch is placed to **2ND STG**. The systems are interconnected electrically so that regardless of switch position, a system will not shut off unless there is at least 2350 psi in the remaining system. The servo shutoff valve operates on current from the No. 1 and No. 2 dc primary buses through circuit breakers marked **NO. 1** and **NO. 2 SERVO CONTR** respectively.

2.36.4 Flight Control Servo Low-Pressure Caution Lights. The first, second, and tail rotor stage servo hydraulic low-pressure caution lights are marked **#1 PRI SERVO PRESS**, **#2 PRI SERVO PRESS**, and **#1 TAIL RTR SERVO**, and will go on if the pressure is below its respective switch setting, or if the servo pilot valve becomes jammed. The servo switches and warning lights operate on direct current from the No. 1 and No. 2 dc primary buses through circuit breakers, marked **NO. 1 SERVO WARN** and **NO. 2 SERVO WARN**, respectively.

2.36.5 Pilot-Assist Servos. Pilot assist servos are normally powered by the No. 2 hydraulic system. If the No. 2 hydraulic pump fails, the pilot assist servos and pitch trim actuator are powered by the backup hydraulic pump. The following units are pilot-assist servos: collective, yaw, and pitch boost servos, which reduce control forces; and three (pitch, roll, yaw) SAS actuators which transfer the output of the SAS controllers into control actuations.

2.36.6 Boost Servo. There are three boost servos, collective, yaw, and pitch, installed between the cockpit controls and mixing unit, which reduce cockpit control forces. The collective and yaw boost servos are turned on and off by pressing the button marked **BOOST** on the **AUTO FLIGHT CONTROL** panel (Figure 2-15). The pitch boost servo is turned on when **SAS 1** or **SAS 2** is **ON**. The boost shutoff valves receive power from the dc essential bus through a circuit breaker, marked **SAS BOOST**.

2.36.7 Pilot-Assist Controls. An **AUTO FLIGHT CONTROL** panel (Figure 2-15), in the lower console, contains the controls for operating the pilot-assist servos and actuators. The panel contains **SAS 1**, **SAS 2**, **TRIM**, **FPS**, **BOOST** and the **FAILURE ADVISORY/POWER ON RESET** lights/switches. **STICK TRIM** and **TRIM REL** switches on the cyclic sticks, are manually operated by either pilot or copilot.

2.37 AUTOMATIC FLIGHT CONTROL SYSTEM (AFCS).

The AFCS enhances the stability and handling qualities of the helicopter. It is comprised of four basic subsystems: Stabilator, Stability Augmentation System (SAS), Trim Systems, and Flight Path Stabilization (FPS). The stabilator system improves flying qualities by positioning the stabilator by means of electromechanical actuators in response to collective, airspeed, pitch rate and lateral acceleration inputs. The stability augmentation system provides short term rate damping in the pitch, roll, and yaw axes. Trim/FPS system provides control positioning and force gradient functions as well as basic autopilot functions with FPS engaged.

2.37.1 Stability Augmentation System (SAS).

NOTE

As the vertical gyro comes up to speed or when the system is shutdown, the derived pitch/roll rate signal which feeds **SAS 1** will cause small oscillations in pitch and roll SAS actuators. This is a temporary situation and can be eliminated by turning **SAS 1** off.

The SAS enhances dynamic stability in the pitch, roll, and yaw axes. In addition, both **SAS 1** and **SAS 2** enhance turn coordination by deriving commands from lateral accelerometers which together with roll rate signals are sent to their respective yaw channels automatically at airspeeds greater than 60 knots. The **SAS 1** amplifier circuitry operates on 28 vdc power from the dc essential bus through a circuit breaker marked **SAS BOOST** providing excitation for the electronic components within the amplifier. AC power from the ac essential bus through a circuit breaker marked **SAS AMPL** is also required for normal operation of the SAS. The SAS amplifier uses the vertical gyro roll output to derive roll attitude and rate for the roll SAS commands and an ac-powered yaw rate gyro for the yaw SAS commands. Loss of ac power to the vertical gyro or SAS amplifier causes erratic operation of **SAS 1** due to loss of the reference for the ac demodulators. When this condition is encountered, the pilot must manually disengage **SAS 1**. In case of a malfunction of the **SAS 2** function, the input will normally be removed from the actuator and the **SAS 2** fail advisory light on the **AUTOFLIGHT CONTROL** panel will go on. If the malfunction is of an intermittent

nature the indication can be cleared by simultaneously pressing **POWER ON RESET** switches. If the malfunction is continuous, the **SAS 2** should be turned off. With **SAS 1** or **SAS 2** off, the control authority of the stability augmentation system is reduced by one-half (5% control authority). Malfunction of the **SAS 1** system may be detected by the pilot as an erratic motion in the helicopter without a corresponding failure advisory indication. If a malfunction is experienced, **SAS 1** should be turned off. SAS actuator hydraulic pressure is monitored. In case of loss of actuator pressure, or if both **SAS 1** and **SAS 2** are off, the **SAS OFF** caution light will go on.

2.37.2 Trim System. When the **TRIM** is engaged on the **AUTO FLIGHT CONTROL** panel, the pitch, roll and yaw trim systems are activated to maintain position of the cyclic and tail rotor controls. Proper operation of the yaw trim requires that the **BOOST** on the **AUTO FLIGHT CONTROL** panel be on. The tail rotor and lateral cyclic forces are developed in the electromechanical yaw and roll trim actuators. Both yaw and roll trim actuators incorporate slip clutches to allow pilot and copilot control inputs if either actuator should jam. The forces required to break through the clutch are 80-pounds maximum in yaw and 13 pounds maximum in roll. The longitudinal force is developed by an electrohydraulic actuator operated in conjunction with the SAS/FPS computer. When the pilot applies a longitudinal or lateral force to the cyclic stick with trim engaged, a combination detent and gradient force is felt. The pilot may remove the force by pressing the thumb-operated **TRIM REL** switch on the pilot/copilot cyclic grip. The pedal gradient maintains pedal position whenever the trim is engaged. By placing feet on the pedals, the pedal switches are depressed and the gradient force is removed. The pedals may then be moved to the desired position and released. The pedals will be held at this position by the trim gradient. The pedal trim gradient actuator also includes a pedal damper. The pedal damper is engaged continuously, independent of electric power and the **TRIM** switch on the **AUTO FLIGHT CONTROL** panel. Operation of the trim system is continuously monitored by the SAS/FPS computer. If a malfunction occurs, the SAS/FPS computer will shut off the trim actuator(s) driving the affected axis, and the **TRIM FAIL** and **FLT PATH STAB** caution light will illuminate. If the malfunction is of an intermittent nature, the indication may be cleared by simultaneously pressing both **POWER ON RESET** switches. In addition to the trim release switch, a four-way trim switch on each cyclic stick establishes a trim position without releasing trim. With trim engaged, the trim position is moved in the direction of switch movement. The cyclic is moved by the trim switch in one direction at a time. When **FPS** is engaged, the **TRIM** switch changes the pitch and roll attitude reference instead of the cyclic stick position reference.

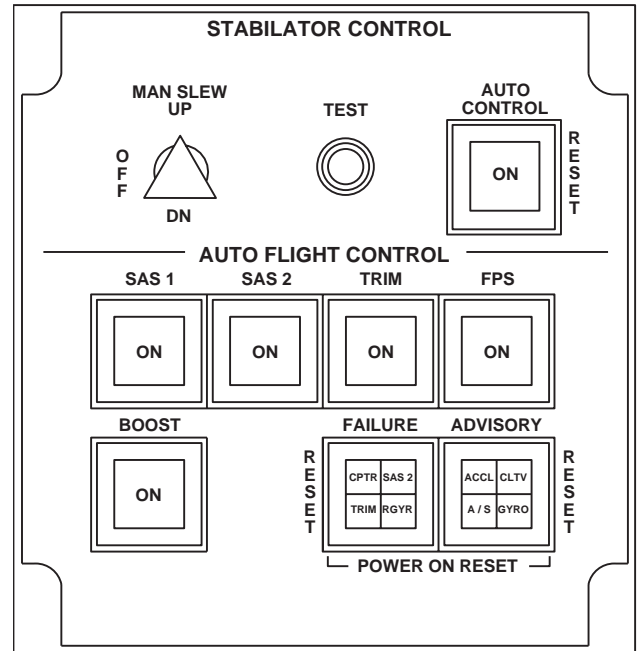

AA0366A
SA

Figure 2-15. Automatic Flight Control System (AFCS) Switch Panel

The trim system release feature permits the pilot or copilot to fly the helicopter with light stick forces. The push-on/push-off **TRIM** switch on the **AUTO FLIGHT CONTROL** panel or the **TRIM REL** switches on the pilot/copilot cyclic grips may be used to release trim. When the switch is **ON**, the trim system provides gradient and detent holding force for pitch, roll, and yaw. When turned off, the trim system is released and light cyclic control forces are present.

2.37.3 Flight Path Stabilization (FPS).

a. Proper FPS operation requires that the **BOOST**, **TRIM** and **SAS 1** and/or **SAS 2** functions have been selected on the **AUTO FLIGHT CONTROL** panel. Although not required for proper operation, the FPS performance will be improved by the proper operation of the stabilator in the automatic mode. To use the FPS features, the pilot first assures that **BOOST**, **SAS** and **TRIM** are on and operating, and then turns the **FPS** switch **ON**. The desired pitch and roll attitude of the helicopter may be established in one of these ways:

- (1) Pressing the **STICK TRIM** switch to slew the reference attitude to the desired attitude.

- (2) Pressing the **TRIM REL** switch on the pilot/copilot cyclic grip, manually flying the helicopter to the desired trim condition, and releasing the **TRIM REL** switch.
- (3) Overriding the stick trim forces to establish the desired trim condition, and then neutralizing stick forces by means of the trim switch.

b. The trim attitude, once established, will be automatically held until changed by the pilot. At airspeeds greater than 60 knots, the pitch axis seeks to maintain the airspeed at which the trim is established, by variation of pitch attitude. When pitch attitude is changed by means of the **STICK TRIM** switch, there is a delay from the time that the **STICK TRIM** switch input is removed until the new reference airspeed is acquired. This is to allow time for the helicopter to accelerate or decelerate to the new trim speed. The yaw axis of the FPS provides heading hold at airspeeds less than 60 knots and heading hold or turn coordination at airspeeds greater than 60 knots. For heading hold operation at airspeeds less than 60 knots, the helicopter is maneuvered to the desired heading with feet on pedals. When trimmed at the desired heading, the pilot may remove feet from pedals, at which time the existing heading becomes the reference, which is automatically held. To change heading, the pilot may activate one or both pedal switches, trim up on the desired heading and remove feet from pedals. At airspeeds greater than 60 knots, heading hold will be automatically disengaged, and coordinated turn engaged under these conditions:

- (1) **STICK TRIM** switch is actuated in the lateral direction.
- (2) **TRIM REL** switch is pressed and roll attitude is greater than prescribed limits.
- (3) About 1/2 inch cyclic displacement and a roll attitude of about 1.5°. Heading hold is automatically reengaged and turn coordination disengaged upon recovery from the turn when the lateral stick force, roll attitude, and yaw rate are within prescribed limits.

c. To make a coordinated turn, the pilot enters a turn in one of these ways:

- (1) Changing reference roll attitude by pressing the **STICK TRIM** switch in the desired lateral direction.
- (2) Pressing **TRIM REL** switch on the cyclic grip and establishing the desired bank angle with feet off pedal switches.

- (3) Exerting a lateral force on the cyclic stick to achieve the desired bank angle, and then neutralizing the force with the **STICK TRIM** switch.
- (4) Keeping a lateral force on the cyclic stick for the duration of the turn.

d. In each of these ways the ball should remain automatically centered during the entry and recovery from the turn. If feet are on the pedals, care must be taken not to apply too much force to the pedals to oppose their motion. If the pilot intentionally miscoordinates the helicopter, the result will be a pedal force roughly proportional to sideslip. The pilot may release the pedal force by pressing the cyclic **TRIM REL** switch with feet on pedals. During transition through 60 knots airspeed, the pilot may feel a slight pedal motion due to a switching transient which may occur when the commanded coordinated turn pedal position differs slightly from the pilot-commanded position. The FPS monitoring is automatic. If a malfunction is detected, the **FLT PATH STAB** caution light will go on and the FPS will either continue to operate in a degraded mode, such as without heading hold, or without airspeed hold; or may cease to function altogether. The pilot must take over manual flight of the helicopter, and may either turn the FPS off or evaluate performance to determine the degree and type of degradation, and continue flight with the remaining features. To help evaluate the nature of the degradation, eight failure advisory indicators are displayed on two **FAILURE ADVISORY** switches on the flight control panel. These tell the pilot the type of sensor or actuator which has experienced the failure. If a light goes on, it may be turned off by pressing the lighted switch. All failure advisory lights will be on at initial application of power. The pilot may attempt to clear the indication of temporary malfunction by simultaneously pressing both **FAILURE ADVISORY** switches. If the **FLT PATH STAB** caution light goes off, it may be assumed that normal operation is restored. All FPS functions are provided by automatically moving the cockpit controls.

2.38 STABILATOR SYSTEM.

a. The helicopter has a variable angle of incidence stabilator to enhance handling qualities. The automatic mode of operation positions the stabilator to the best angle of attack for the existing flight conditions. After the pilot engages the automatic mode, no further pilot action is required for stabilator operation. Two stabilator amplifiers receive airspeed, collective stick position, pitch rate, and lateral acceleration information to program the stabilator through the dual electric actuators. The stabilator is programmed to:

(1) Align stabilator and main rotor downwash in low speed flight to minimize nose-up attitude resulting from downwash.

(2) Decrease angle of incidence with increased air-speed to improve static stability.

(3) Provide collective coupling to minimize pitch attitude excursions due to collective inputs from the pilot. Collective position sensors detect pilot collective displacement and programs the stabilator a corresponding amount to counteract the pitch changes. The coupling of stabilator position to collective displacement is automatically phased in beginning at 30 KIAS.

(4) Provide pitch rate feedback to improve dynamic stability. The rate of pitch attitude change of the helicopter is sensed by a pitch rate gyro in each of the two stabilator amplifiers and used to position the stabilator to help dampen pitch excursions during gusty wind conditions. A sudden pitch up due to gusts would cause the stabilator to be programmed trailing edge down a small amount to induce a nose-down pitch to dampen the initial reaction.

(5) Provide sideslip to pitch coupling to reduce susceptibility to gusts. When the helicopter is out of trim in a slip or skid, pitch excursions are also induced as a result of the main rotor downwash on the stabilator. Lateral accelerometers sense this out of trim condition and signal the stabilator amplifiers to compensate for the pitch attitude change (called sideslip to pitch coupling). Nose left (right slip) results in the trailing edge programming down. Nose right produces the opposite stabilator reaction.

b. The above features are provided via inputs to dual actuators which position the stabilator. Failure of one actuator will restrict total maximum movement of the stabilator to about 35° if failure occurs full down, or about 30° if failure occurs full up. The stabilator actuators receive power from the dc essential bus and No. 2 dc primary bus through circuit breakers marked **STAB PWR**. Since the dc essential bus is powered by the battery, it is possible to manually slew one actuator using battery power only. If the stabilator is slewed up, regain automatic control by manually slewing stabilator full down, then push **AUTO CONTROL RESET** twice. Otherwise, when only one actuator is slewed, it causes a very large mismatch between the two actuator positions. This is detected by the fault monitor and shuts down the automatic mode upon attempted engagement. Automatic control function sensors, airspeed sensors, pitch rate gyros, collective position sensor, and lateral accelerometer receive power from the ac essential bus and No. 2 ac primary bus through circuit breakers marked **STAB CONTR**.

2.38.1 Stabilator Control Panel. The stabilator control panel (Figure 2-8), on the lower console, provides electrical control of the stabilator system. The panel contains a **MAN SLEW** switch, a **TEST** button, and **AUTO CONTROL RESET** switch with a push-to-reset feature. The automatic mode will allow the stabilator to be automatically operated from about 39° trailing edge down to 9° trailing edge up. Manual operation is also restricted to these limits. If a malfunction occurs in the automatic mode, the system will switch to manual, **ON** will go off in the **AUTO CONTROL** window, and the **STABILATOR** caution and **MASTER CAUTION** lights will go on and a beeping tone will be heard in the pilot's and copilot's headphones. It may be possible to regain the auto mode by pressing the **AUTO CONTROL RESET**. If the automatic mode is regained, **ON** will appear in the **AUTO CONTROL** switch window and the caution lights will go off. The stabilator automatic mode is held in the energized state within the stabilator control amplifier. On certain occasions during interruption of dc power, such as switching of generators, it is possible to have conditions where the stabilator automatic mode may shut down. If the automatic mode shuts down during flight because of an ac power failure, the helicopter shall be slowed to 80 KIAS before power is restored. In this case the **AUTO CONTROL RESET** switch may be pressed to reengage the auto mode. The copilot's **STAB POS** indicator may vary from the pilot's indicator as much as 2°. If the automatic mode is not regained, the **MASTER CAUTION** must be reset, which turns off the beeping tone, and the stabilator controlled throughout its range with the **MAN SLEW** switch. When initial power is applied to the stabilator system, it will be in automatic mode. The **TEST** switch is used to check the AUTO mode fault detector feature and is inoperative above 60 KIAS. When pressed, control of the stabilator should go to the manual mode.

2.38.2 Stabilator Position Indicator. Two **STAB POS** indicators (Figure 2-9) are on the instrument panel. They give pilots a remote indication of stabilator position. The indicator range is marked from 45° **DN** to 10° **UP**. The stabilator position indicator system is powered from the ac essential bus 26V through a circuit breaker marked **STAB IND**.

2.38.3 Cyclic-Mounted Stabilator Slew Up Switch. Installed on each cyclic stick below the grip (Figure 2-14) is a pull-type stabilator manual slew up switch. The switch provides the pilot and copilot with rapid accessibility to stabilator slew up. The cyclic slew switch is wired in parallel with the stabilator panel **MAN SLEW-UP** switch position. When the switch is actuated, the stabilator trailing edge will begin to move up and continue until the up limit stop is reached or the switch is released.

Section VI HYDRAULIC AND PNEUMATIC SYSTEM

2.39 HYDRAULIC SYSTEM.

The three hydraulic systems are designed to provide full flight control pressure. The components of the hydraulic systems are three hydraulic pump modules, two transfer modules, a utility module, three dual primary servos, one dual tail rotor servo, four pilot-assist servos, an APU accumulator, an APU handpump, and a servicing handpump. There are three hydraulic pressure supply systems, number 1, number 2, and backup. All are completely independent and each is fully capable of providing essential flight control pressure for maximum system redundancy. Complete redundancy is accomplished by the backup pump providing hydraulic power to both number 1 and/or number 2 systems if one or both pumps fail. If two systems lose pressure, there will be a slight restriction in the maximum rate of flight control movement due to only one pump supplying both stages with hydraulic power. An automatic turnoff feature is provided. When the **SVO OFF** switch (Figure 2-14) is moved to **1ST STG** or **2ND STG** position, that stage of the primary servos is turned off. When the **SVO OFF** switch is moved to **1ST STG**, the first stage of the primary servos is turned off. A malfunction in the second stage will cause first stage (which was turned off) to automatically turn back on in case the backup system does not take over the function of the failed second stage. If the second stage is initially turned off, the sequence is reversed. An additional hydraulic handpump is provided for APU start system.

NOTE

The following listed caution lights may momentarily flicker when the applicable listed switch is activated; this is considered normal.

SUBSYSTEM	CAUTION LIGHT
SAS 1 or SAS 2 switch ON	#2 PRI SERVO PRESS #2 HYD PUMP BOOST SERVO OFF
BOOST switch ON	#2 PRI SERVO PRESS #2 HYD PUMP SAS OFF
TAIL SERVO switch BACKUP	#1 PRI SERVO PRESS #1 HYD PUMP

SUBSYSTEM

CAUTION LIGHT

HYD LEAK TEST switch NORM after RESET	#1 and #2 PRI SERVO PRESS #1 and #2 HYD PUMP
---------------------------------------	---

2.40 HYDRAULIC PUMP MODULES.

The hydraulic pump modules are combination hydraulic pumps and reservoirs. The No. 1, No. 2, and backup pump modules are identical and interchangeable with each other. The No. 1 pump module is mounted on and driven by the left accessory module of the main transmission. The No. 2 pump module is mounted on and driven by the right accessory transmission module. The backup pump module is mounted on and driven by an ac electric motor. The reservoir part of each pump module has a level indicator window marked, **REFILL**, **FULL**, and **EXPANSION**. A pressure relief and bleed valve protects the pump from high pressure in the return system. The pump has two filters: a pressure filter and a return filter. A red indicator button on each filter will pop out when pressure goes up 70 ± 10 psi above normal. The pressure filter has no bypass. The return filter has a bypass valve that opens when return pressure reaches 100 ± 10 psi above normal. Each pump has three check valves: one at the external ground coupling, one at the pressure side, and one at the return side. A fluid quantity switch, mounted on top of each pump module, senses fluid loss for that system. When the piston in the pump module moves down to the **REFILL** mark, the piston closes the switch, turning on a caution light marked **RSVR LOW**. Each hydraulic pump has two temperature sensitive labels mounted on the side. When a temperature level is reached a circle turns black. There are two types of labels used on the pumps. When the temperature label indicates that a temperature of 132°C (270°F) has been exceeded, an entry shall be made on DA Form 2408-13-1. The aircraft should not be flown until appropriate maintenance action has been taken.

2.40.1 Number 1 Hydraulic System. Number 1 hydraulic system operates with the rotor turning, and supplies the first stage of all primary servos and the first stage of the tail rotor servo. The system components are an integrated pump module, a transfer module, first stage primary servos, and first stage tail rotor servo. The primary servos are controlled by the **SVO OFF** switch (Figure 2-14). The switch can turn off either first or second stage of the primary servos but not both at the same time. First stage tail rotor

servo can be manually turned off by a two-position switch marked **TAIL SERVO**, on the miscellaneous switch panel (Figure 2-8). If the fluid quantity of the number one pump reservoir becomes low, a microswitch will complete an electrical circuit to close the first stage tail rotor servo valve. If fluid continues to be lost and the **#1 HYD PUMP** caution light goes on, the first stage tail rotor shutoff valve will open, allowing backup pressure to supply first stage tail rotor. The logic modules automatically control the hydraulic system. The tail rotor servo is a two-stage servo but, unlike the primary servos, only one stage is pressurized at a time.

2.40.2 Number 2 Hydraulic System. The number 2 hydraulic system, which also operates with the rotor turning, supplies the second stage primary servo and the pilot-assist servos. System components are the integrated pump module, transfer module, second stage primary servos, and pilot-assist modules. Second stage primary servos can be manually turned off by the **SVO OFF** switch. The pilot-assist servos cannot be turned off collectively, but **SAS**, **TRIM** and **BOOST** servos can be manually turned off by switches on the **AUTO FLIGHT CONTROL** panel. If fluid quantity of the number two pump reservoir becomes low, the pilot-assist servo becomes inoperative. If fluid continues to be lost, the **#2 HYD PUMP** caution light will go on.

2.40.3 Backup Hydraulic System.



Whenever the No. 1 ac generator is inoperative (failed, or not on line) and the BACKUP PUMP PWR circuit breaker is out for any reason, ac electrical power must be shut off before resetting BACKUP PUMP PWR circuit breaker. Otherwise, it is possible to damage the current limiters.

The backup hydraulic pump system supplies emergency pressure to the number 1 and/or number 2 hydraulic systems whenever a pressure loss occurs. It also supplies pressure to the number 2 stage of the tail rotor servo in case of a loss of pressure in the first stage of the tail rotor servo or **#1 RSVR LOW** indication. This system supplies hydraulic pressure to all flight control components during ground checkout. The backup system also provides a hydraulic pressure for automatic recharging of the APU start system accumulator. The backup hydraulic system pump module is driven by an electric motor which can be powered by any

adequate three-phase ac power source. An internal depressurizing valve in the backup pump module reduces the output pressure of the pump upon startup of the electric motor. This valve unloads the electric motor by reducing torque requirement at low rpm. After about 0.5 second when main generator is operating, or 4 seconds when operating from APU generator or external power, the valve is closed and 3000 psi pressure is supplied to the hydraulic system. This sequence reduces the current demand during backup system startup. Pressure sensing switches in the number 1 and number 2 transfer modules constantly monitor the pressure output of the number 1 and number 2 pumps. Loss of pressure initiates the backup operation. The system then provides emergency pressure to maintain full flight control capability. A **WOW** switch on the left main landing gear provides automatic operation of the backup pump when the helicopter is in the air, regardless of **BACKUP HYD PUMP** switch position, and disables the backup pump ac thermal switch. A pressure sensing switch at the tail rotor monitors supply pressure to the first stage tail rotor servo. The backup pump can supply pressure to the first stage tail rotor servo if the number 1 pump loses pressure. This gives the pilot a backup tail rotor servo even with the loss of the primary hydraulic supply, or **#1 RSVR LOW**. If a leak in a primary servo system depletes the backup system fluid, the backup reservoir level sensing switch will turn on the **BACK-UP RSVR LOW** caution light, and the pilot must manually turn off the leaking primary system.

2.41 HYDRAULIC LEAK DETECTION/ISOLATION SYSTEM.

The leak detection/isolation (LDI) system protects the flight control hydraulic system by preventing the further loss of hydraulic fluid in case of a leak. The LDI system uses pressure switches and fluid level sensors for monitoring pump hydraulic fluid level, and pump pressure for primary and tail rotor servos, and pilot-assist servos. When a pump module reservoir fluid level switch detects a fluid loss, the logic module follows the sequence detailed in Figure 2-16 to isolate the leak. To accomplish this, the logic module operates the required shutoff valve(s) to isolate the leak and turns on the backup pump when required. In the cockpit the **RSVR LOW** caution light for that system lights. Backup pump and shutoff valve(s) operation is automatic through the logic module. If, after the isolation sequence, the leak continues, the leakage is in the stage 1 or 2 primary servos and the appropriate **SVO OFF** switch must be moved to the off position by the pilot. By placing the **HYD LEAK TEST** switch to **TEST**, all leak detection/isolation system components are checked electrically. After a leak test has been made, the **HYD LEAK TEST** switch must be moved to **RESET** momentarily, to turn off caution and advisory lights that were on during the test. The

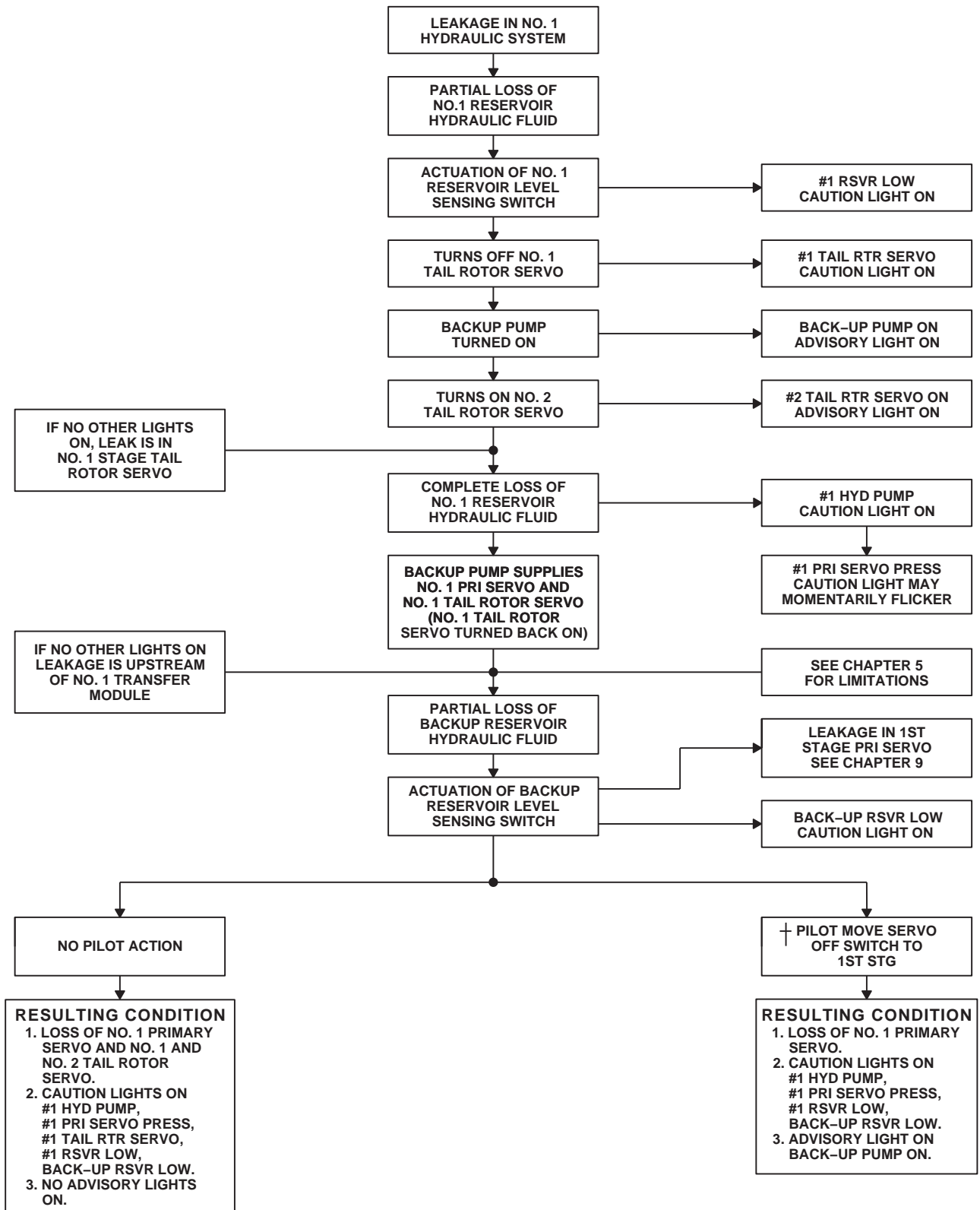
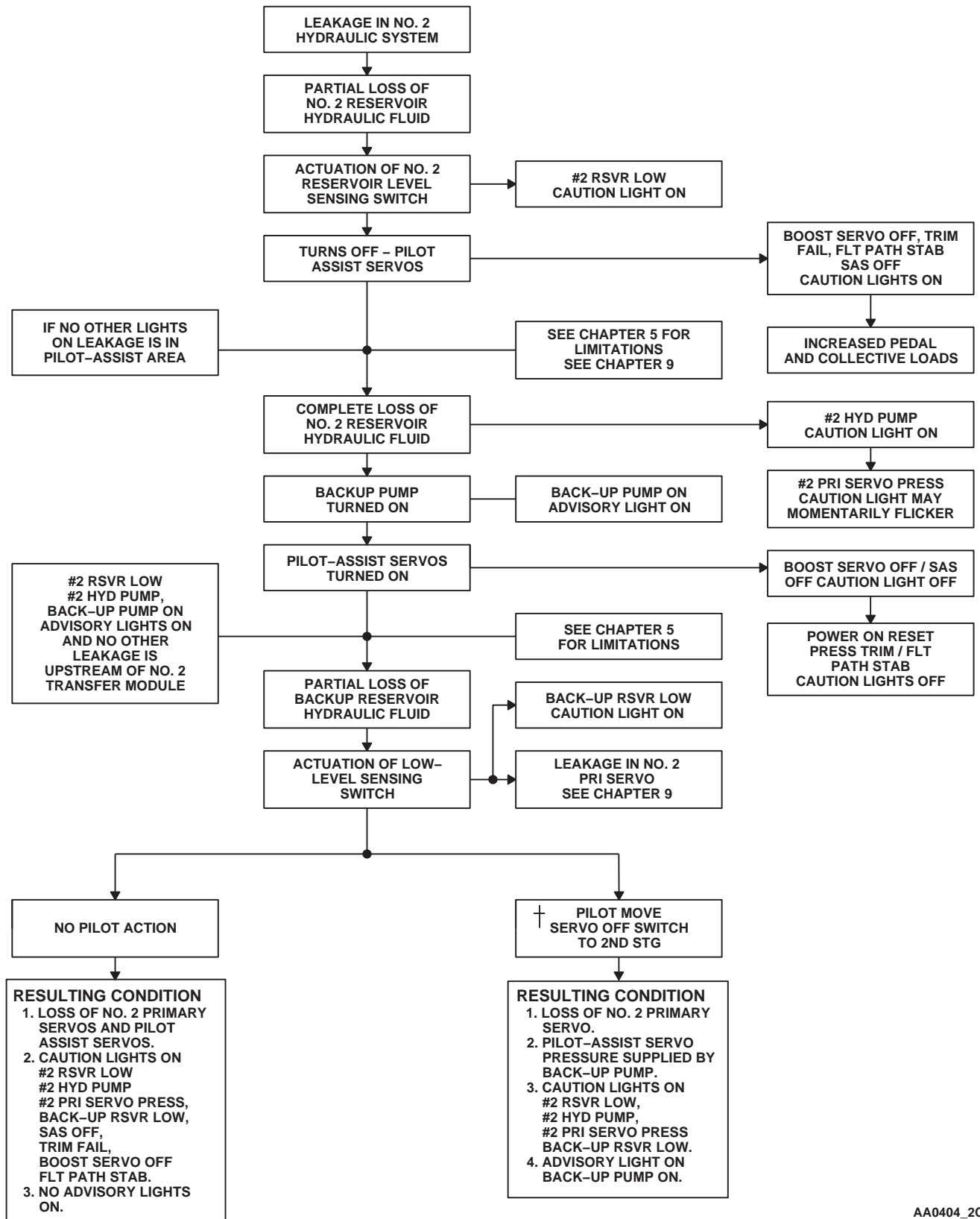

Figure 2-16. Hydraulic Logic Module Operation Principle (Sheet 1 of 2)



AA0404_2C
SA

Figure 2-16. Hydraulic Logic Module Operation Principle (Sheet 2 of 2)

BACK-UP PUMP ON advisory light will remain on for about 90 seconds. Refer to Chapter 8 Section II for test procedure. Except for the **HYD LEAK TEST** switch, the hydraulic leak system consists of components of 1st stage, 2nd stage and backup hydraulic systems. A WOW switch contact prevents hydraulic leak tests from being made in flight. Power to operate the hydraulic leak test system is from the No. 2 dc primary bus through a circuit breaker, marked **NO. 2 SERVO CONTR** and dc essential bus through a circuit breaker, marked **BACKUP HYD CONTR**.

2.42 TRANSFER MODULES.

The No. 1 and No. 2 transfer modules connect hydraulic pressure from the pump modules to the flight control servos. Each module is an integrated assembly of shutoff valves, pressure switches, check valves, and restrictors. The modules are interchangeable.

2.42.1 No. 1 Transfer Module. This module has a transfer valve, a pressure switch, a 1st stage primary shutoff valve, a 1st stage tail rotor shutoff valve, a restrictor, and check valves. The transfer valve is spring-loaded to the open or normal position. If 1st stage hydraulic pressure is lost, the valve automatically transfers backup pump pressure to the 1st stage system. The 1st stage primary shutoff valve lets the pilot or copilot shut off 1st stage pressure to the primary servos and prevents both stages from being shut off at the same time. The pressure switch lights the **#1 HYD PUMP** light on the caution advisory panel when pressure drops below 2000 psi and also sends a signal to a logic module that pressure is lost in the 1st stage hydraulic system. The restrictor allows fluid to circulate for cooling under no-flow conditions. If a fluid leak develops past the transfer module, the check valves prevent fluid loss on the return side of the transfer module.

2.42.2 No. 2 Transfer Module. The No. 2 transfer module is like the No. 1 module except that it supplies 2nd stage pressure. The pilot assist shutoff valve turns off pressure to the pilot assist module. The 2nd stage primary servo shutoff valve turns off pressure to the 2nd stage of the primary servos. The pressure switch turns on the **#2 HYD PUMP** caution light on the caution/advisory panel when 2nd stage system pressure is below 2000 psi, and also sends a signal to a logic module that pressure is lost in the 2nd stage system.

2.42.3 Utility Module. The utility module connects hydraulic pressure from the backup pump to the No. 1 and No. 2 transfer modules, the 2nd stage of the tail rotor servo, and the APU accumulator. A pressure switch on the module senses the backup pump operating and turns on the **BACK-UP PUMP ON** advisory light on the caution/advisory panel. If the flow rate through the module to the APU accumulator goes over 1-1/2 gpm, a velocity fuse shuts off flow.

2.42.4 Logic Modules. Two logic modules, one in the left relay panel and the other in the right relay panel, are used to control the operation of the hydraulic systems. The logic modules continually monitor the operation of the hydraulic systems by inputs received from pressure switches, fluid level switches on the pump modules, and inputs received from control switches in the hydraulic system. The outputs of the logic modules will either turn on lights on the caution/advisory panel notifying the pilot of a failure, and/or turn off one or more valves due to a system malfunction. All switching functions of the hydraulic logic modules are automatic, except as shown by a dagger (†) which indicates crewmember action (Figure 2-16).

2.43 RESERVOIR FILL SYSTEM.

A handpump and manual selector valve are on the right side upper deck of the helicopter for system servicing. Refer to Figure 2-25 for servicing. The three hydraulic system reservoir levels can be seen from the fill pump location. The handpump reservoir contains a sight gage above the handpump crank. A 1-quart level mark indicates a requirement for refill. Refer to Section XV this chapter for servicing.

2.44 PNEUMATIC SUBSYSTEM.

A pneumatic subsystem operating from bleed-air furnished by the main engines, the APU, or an external pneumatic power source, is used to drive the main engine starter, for heating system operation and external extended range tank fuel transfer. Bleed-air from the main engines is used for engine inlet anti-icing subsystem operation. The heating subsystem and the extended range fuel tanks use bleed-air supplied by the main engines during flight, and on the ground by the main engines, APU, or external source. The subsystem contains check valves at each bleed-air source, and a shutoff valve at each main engine.

Section VII POWERTRAIN SYSTEM

2.45 POWERTRAIN.

The powertrain consists of inputs from two engines, a main transmission, intermediate gear box, tail gear box and connecting drive shafting. Power from the engines is transmitted to the main transmission module through input modules. The main transmission is mounted on top of the cabin between the two engines (Figure 2-1). It mounts and powers the main rotor head, changes the angle of drive from the engines, reduces rpm from the engines, powers the tail rotor drive shaft and drives the accessory module. The main transmission consists of five modules: two input modules; the main module; and two accessory modules. The main transmission has a built-in 3° forward tilt.

2.45.1 Input Module. The input modules are mounted on the left and right front of the main module and support the front of the engines. They contain an input bevel pinion and gear, and a freewheel unit. The freewheel unit allows engine disengagement during autorotation, or in case of a nonoperating engine, the accessory module will continue to be driven by the main rotor. The input module provides the first gear reduction between engine and main module.

2.45.2 Accessory Module. One accessory module is mounted on the forward section of each input module. Each accessory module provides mounting and drive for an electrical generator and a hydraulic pump package. A rotor speed sensor is mounted on the right accessory module and provides signals for the VIDS. On the UH-60L an additional rotor speed sensor is mounted on the left accessory module which provides input signals to the DEC for improved transient droop response.

2.45.3 Main Module. The main module contains the necessary gearing to drive the main rotor and tail rotor systems. It provides a reduction in speed from the input module to the main module and the tail drive shaft.

2.46 MAIN TRANSMISSION LUBRICATION SYSTEM.



UH-60A EH Prolonged nose-down attitudes of 5 degrees or more may cause high main transmission oil temperature.

The transmission incorporates an integral wet sump lubrication system that provides cooled, filtered oil to all bearing and gears. The ac generators on the accessory modules also receive oil for cooling. Oil under pressure is supplied through internally cored oil lines, except for the pressure and return lines of the oil cooler. Refer to servicing diagram for oil specification and servicing (Table 2-4). The lubrication system includes two lubrication pumps that are combination pressure and scavenge types operating in parallel. The main transmission may run at cruise flight for 30 minutes with loss of all oil. Main transmission oil pressure may fluctuate when the aircraft is known to be in a nose-up attitude (i.e., slope landings or hover with an extreme aft CG). Pressure regulating and bypass valves protect the lube system by returning excess high pressure oil back to the inlet side of the pump. A two-stage oil filter and various strainers in the sump prevent contamination. The oil filter has a visual impending bypass indicator (red button) that protrudes when the first stage filter becomes contaminated. When the button pops the filter element must be replaced to reset. A thermal lockout prevents button popping when oil is cold and thick. The oil cooler uses a blower driven by the tail rotor drive shaft to cool oil before it enters the various modules. The oil cooler has a thermostatic bypass valve that directs oil flow around the cooler when the oil temperature is below $71^{\circ}\pm 1^{\circ}\text{C}$. Other warning and monitoring systems on the main transmission are: **MAIN XMSN OIL TEMP** and **PRESS** caution lights, and **XMSN TEMP** and **PRESS** oil temperature gages. An oil pressure switch on the left accessory module, the farthest point from the pumps, causes the **MAIN XMSN OIL PRESS** caution light to go on when the pressure drops to 14 ± 2 psi. The transmission oil temperature warning system is triggered by an oil temperature switch at the oil cooler input to the main module, near the tail takeoff drive shaft flange. A caution light, **MAIN XMSN OIL TEMP** goes on when transmission oil temperature reaches 120°C . Temperature for the gage is sensed between the sump and the pump. Pressure readings are taken at the main module manifold. Electrical power for the warning systems, except chip detection, is from the No. 2 dc primary bus, through the **MAIN XMSN** circuit breaker on the overhead circuit breaker panel.

2.46.1 Transmission Oil Temperature Indicator. The transmission oil temperature indicator marked **XMSN TEMP** is a part of the central display unit (Figure 2-9). Refer to Chapter 5 for limitations. Power to operate the temperature indicator and **MAIN XMSN OIL TEMP** caution light is provided from the No. 1 and No. 2 ac primary

buses through the signal data converters and the No. 2 dc primary bus through a circuit breaker, marked **MAIN XMSN**.

2.46.2 Transmission Oil Pressure Indicator. The transmission oil pressure indicator, marked **XMSN PRESS**, is a part of the central display unit (Figure 2-9). Refer to Chapter 5 for limitations. Power to operate the pressure indicator and **MAIN XMSN OIL PRESS** caution light is provided from the No. 1 and No. 2 ac primary buses through the signal data converter and No. 2 dc primary bus through a circuit breaker marked **MAIN XMSN**.

2.46.3 Transmission Chip Detector System. The transmission chip detector system consists of chip detectors on the left and right input modules, left and right accessory modules, the main gear box module, and caution lights marked **CHIP INPUT MDL-LH**, **CHIP INPUT MDL-RH**, **CHIP ACCESS MDL-LH**, **CHIP ACCESS MDL-RH** and **CHIP MAIN MDL SUMP**. These detectors provide warning of chips in any of five areas of the main transmission system. Each chip detector incorporates a self-sealing provision so that it can be removed for visual inspection without loss of oil. The magnetic plugs on each chip detector attract ferrous particles at any of the detector locations. The fuzz burn-off feature prevents false warnings by burning off small chips and fuzz. The fuzz burn-off feature is deactivated when oil temperature reaches 140°C. Deactivation of the fuzz burn-off feature does not disable detection and illumination of caution lights. The main transmission chip detector is also connected to a 30 second time delay relay to allow small chips and fuzz to burn off and/or wash away. Chips that are too large to burn off or wash away trigger the detection system which illuminates a caution light on the caution/advisory panel. The pilot or maintenance personnel must check the caution/advisory panel before removing power to determine the location of the chip. The system is powered by the dc essential bus through a circuit breaker on the upper console circuit breaker panel marked **CHIP DET**.

2.46.4 Built In Test (BIT) Chip Detectors.

NOTE

The **MASTER CAUTION PRESS TO RESET** light may or may not extinguish after being pressed to reset while the chip detectors BIT is in progress.

BIT chip detectors will automatically test for a continuous circuit from the caution/advisory panel to the individual chip detector when power is first applied. Chip detector

caution lights illuminate during test and extinguish after successful completion of test. When first placing the **BATT** switch **ON**, the **CHIP INPUT MDL-LH**, **CHIP ACCESS MDL-LH**, **CHIP INT XMSN**, **CHIP TAIL XMSN**, **CHIP INPUT MDL-RH**, and **CHIP ACCESS-RH** illuminate immediately for approximately 45-70 seconds and then extinguish. The **CHIP MAIN MDL SUMP** caution light illuminates after a 30 second delay for approximately 30 seconds and then extinguishes. A caution light that does not illuminate indicates a failed test on its chip detector circuit.

2.47 TAIL DRIVE SYSTEM.

Six sections of drive shaft connect the main module to the tail rotor gear box. The shafts drive the oil cooler blower and transmit torque to the tail rotor. Each shaft is dynamically balanced tubular aluminum. Multiple disc (flexible) couplings between sections eliminate universal joints. The shafts are ballistically tolerant if hit by a projectile and are suspended at four points in viscous-damped bearings mounted in adjustable plates and bolted to fuselage support brackets.

2.47.1 Intermediate Gear Box. Mounted at the base of the pylon is the oil-lubricated intermediate gear box (Figure 2-1). It transmits torque and reduces shaft speed from the main gear box to the tail gear box. The intermediate gear box may run at cruise flight for 30 minutes, with loss of all oil. An internal metal fuzz suppression chip/temperature sensor detects metal particles and gear box overtemperature conditions, to light caution panel lights marked **CHIP INT XMSN** and **INT XMSN OIL TEMP**.

2.47.2 Tail Gear Box. The oil-lubricated tail gear box (Figure 2-1) at the top of the tail pylon transmits torque to the tail rotor head. The gear box mounts the tail rotor, changes angle of drive and gives a gear reduction. It also enables pitch changes of the tail rotor blades through the flight control system. The gear box housing is magnesium. The tail gear box may run at cruise flight for 30 minutes with loss of all oil. An internal fuzz suppression metal chip/temperature sensor detects metal particles, and gear box overtemperature conditions, to light caution panel lights, marked **CHIP TAIL XMSN** and **TAIL XMSN OIL TEMP**.

2.47.3 Intermediate and Tail Gear Box Chip/Temperature Systems. The intermediate and tail gear boxes contain identical chip/temperature sensors that indi-

cate in the cockpit when the gear box temperature is too high, or a chip is present. The chip detectors incorporate a fuzz burn-off feature which eliminates false warning due to fuzz and small particles. When a chip is detected and will not burn off, a caution light on the caution/advisory panel will go on, indicating **CHIP INT XMSN** or **CHIP TAIL XMSN**. Power to operate the chip system is provided from the dc essential bus through a circuit breaker marked **CHIP**

DET. The oil temperature sensor is a bimetal strip that reacts to temperatures. When the oil temperature reaches 140°C a switch closes to turn on a caution capsule in the cockpit, marked **INT XMSN OIL TEMP** or **TAIL XMSN OIL TEMP**. Power to operate the oil temperature system is from the No. 2 dc primary bus through a circuit breaker marked **MAIN XMSN**.

Section VIII MAIN AND TAIL ROTOR GROUPS

2.48 ROTOR SYSTEMS.

The rotor system consists of a main rotor and tail rotor. Both systems are driven by the engines through the transmission system, with pitch controlled by the flight control system.

2.49 MAIN ROTOR SYSTEM.

The main rotor system consists of four subsystems: main rotor blades, hub, flight controls and the bifilar vibration absorber. Four titanium-spar main rotor blades attach to spindles which are retained by elastomeric bearings contained in one-piece titanium hub. The elastomeric bearing permits the blade to flap, lead and lag. Lag motion is controlled by hydraulic dampers and blade pitch is controlled through adjustable control rods which are moved by the swashplate. When the rotor is not turning, the blades and spindles rest on hub mounted droop stops. Upper restraints called antflapping stops retain flapping motion caused by the wind. Both stops engage as the rotor slows down during engine shutdown. Blade retaining pins can be pulled from the blade spindle joint and the blades folded along the rear of the fuselage. The bifilar vibration absorber reduces rotor vibration at the rotor. The absorber is mounted on top of the hub and consists of a four arm plate with attached weights. Main rotor dampers are installed between each of the main rotor spindles modules and the hub to restrain hunting (lead and lag motions) of the main rotor blades during rotation and to absorb rotor head starting loads. Each damper is supplied with pressurized hydraulic fluid from a reservoir mounted on the side of each damper. The reservoir has an indicator that monitors the reserve fluid. When the damper is fully serviced, the indicator will show full gold.

2.49.1 Main Rotor Blades. Four main rotor blades use a titanium spar for their main structural member. The structure aft of the spar consists of fiberglass skin, Nomex honeycomb filler and a graphite/fiberglass trailing edge. The leading edge of each blade has a titanium abrasion strip, the outboard portion of which is protected by a replaceable nickel strip. Electro-thermal blankets are bonded into the blades leading edge for deicing. A Blade Inspection Method (BIM®) indicator (Figure 2-17), is installed on each blade at the root end trailing edge to visually indicate when blade

spar structural integrity is degraded. If a spar crack occurs, or a seal leaks, nitrogen will escape from the spar. When the pressure drops below minimum the indicator will show red bands. A manual test lever is installed on each BIM indicator to provide a maintenance check. The blades are attached to the rotor head by two quick-release expandable pins, that require no tools to either remove or install. To conserve space, all blades can be folded to the rear and downward along the tail cone. When mooring, the blades can be tied down with a fitting on the bottom of each blade.

2.49.2 Main Rotor Gust Lock. The gust lock prevents the blades from rotating when the helicopter is parked. The gust lock is designed to withstand torque from one engine at **IDLE**, and thus allow engine maintenance checks independent of drive train rotation. The locking system consists of a locking handle at the rear of the cabin (Figure 2-5), a **GUST LOCK** caution light on the caution/advisory panel (Figure 2-9), and a locking device and teeth on the tail rotor takeoff flange of the main transmission. The lock shall only be applied when the rotor system is stationary; it can only be released when both engines are shut down. Power to operate the caution light is provided from the No. 1 dc primary bus through a circuit breaker marked **LIGHTS ADVSY**.

2.50 TAIL ROTOR SYSTEM.

A cross-beam tail rotor blade system provides anti-torque action and directional control. The blades are of graphite and fiberglass construction. Blade flap and pitch change motion is provided by deflection of the flexible graphite fiber spar. This feature eliminates all bearings and lubrication. The spar is a continuous member running from the tip of one blade to the tip of the opposite blade. Electro-thermal blankets are bonded into the blade leading edge for deicing. The tail rotor head and blades are installed on the right side of the tail pylon, canted 20° upward. In addition to providing directional control and anti-torque reaction, the tail rotor provides 2.5% of the total lifting force in a hover. A spring-loaded feature of the tail rotor control system will provide a setting of the tail rotor blades for balance flight at cruise power setting in case of complete loss of tail rotor control.

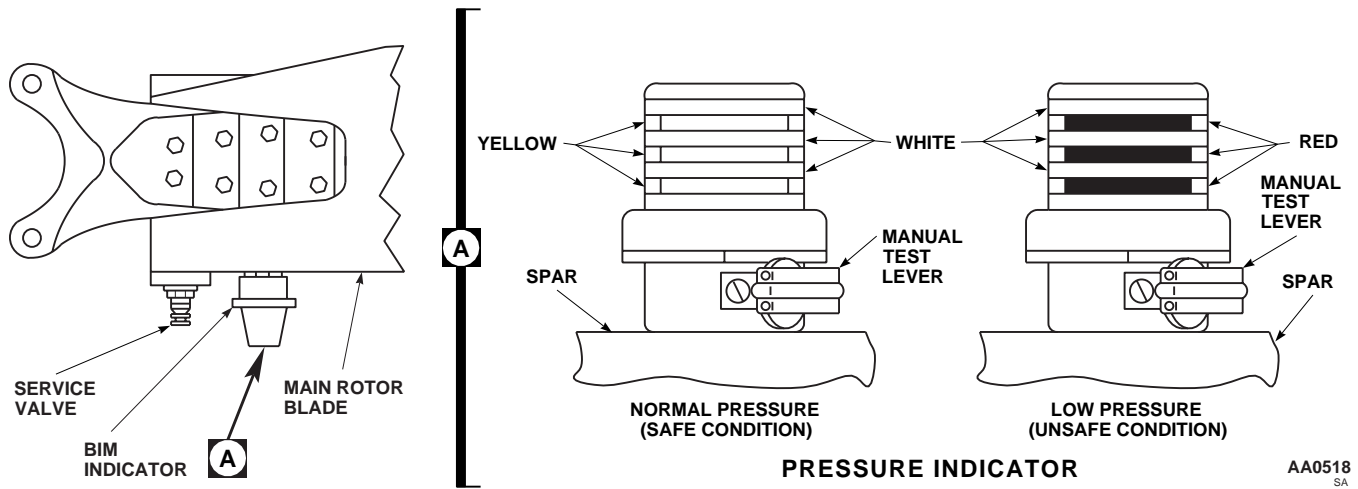

Figure 2-17. Main Rotor Blade and BIM® System

2.51 TAIL ROTOR QUADRANT/WARNING.

The tail rotor quadrant contains microswitches to turn on a caution light marked **TAIL ROTOR QUADRANT** if a tail rotor cable becomes severed. Spring tension allows the quadrant to operate in a normal manner. Electrical power to operate the warning system is provided from No. 1 dc primary bus through a circuit breaker marked **T RTR SERVO**

WARN. If the helicopter is shut down and/or hydraulic power is removed with one tail rotor cable failure, disconnection of the other tail rotor cable will occur when force from the boost servo cannot react against control cable quadrant spring tension. The quadrant spring will displace the cable and boost servo piston enough to unlatch the quadrant cable.

Section IX UTILITY SYSTEMS

2.52 WINDSHIELD WIPERS.

Two electrically-operated windshield wipers are installed, one on the pilot's windshield and one on the copilot's windshield (Figure 2-1). Both wiper arms are driven by a common motor through flexible drives and converters. Power to operate the windshield wiper system is from No. 1 ac primary bus through a circuit breaker, marked **WSHLD WIPER**.

NOTE

The use of rain repellent on the windshields will improve visibility above speeds of 50 KIAS. Rain repellent may be locally purchased.

2.52.1 Windshield Wiper Control.



To prevent possible damage to windshield surface, do not operate windshield wipers on a dry windshield.

Control of the windshield wipers is through a spring-loaded rotary switch on the upper console (Figure 2-7). The switch is labeled **WINDSHIELD WIPER**, with marked positions **PARK-OFF-LOW-HI**. When the switch is turned from **OFF** to **LOW** or **HI**, the wipers will operate at the corresponding speed. The wipers will stop at any position when the switch is turned **OFF**. When the switch is turned to **PARK**, the wipers will return to the inboard windshield frame and stop. When the switch is released, it will return to **OFF**.

2.52.2 Windshield Anti-Ice/Defogging System.



Continued use of a faulty windshield anti-ice system may result in structural damage (delamination and/or cracking) to the windshield.

Do not allow ice to accumulate on the windshield, as ice shedding can cause engine FOD.

Pilot's, copilot's and center windshields (on helicopters equipped with center windshield anti-ice system) are electrically anti-iced and defogged. Transparent conductors imbedded between the laminations provide heat when electrical power is applied. The temperature of each panel is controlled to a heat level of about 43°C (109°F). The windshield anti-ice system fault monitoring circuit prevents windshield burnout when the windshield surface heat is above 43°C (109°F). If heat increases, the monitor circuit will turn off the system. Three switches, one for the pilot, one for the copilot and one for the center windshield, (when equipped) are on the upper console (Figure 2-7) with markings of **WINDSHIELD ANTI-ICE PILOT-OFF-ON**, and **COPILOT-OFF-ON**. On helicopters equipped with center windshield anti-ice an additional switch to control the center windshield is marked **WINDSHIELD ANTI-ICE-CTR-OFF-ON**. Power to operate the anti-icing system is provided by the No. 1 and No. 2 ac primary buses through circuit breakers marked **PILOT WSHLD ANTI-ICE** and **CPLT WSHLD ANTI-ICE**. On helicopters equipped with center windshield anti-ice, pilot and center windshield anti-ice circuit breakers are marked **WINDSHIELD ANTI-ICE PILOT** and **CTR**. Power to control the anti-ice system is provided by the No. 1 and No. 2 dc primary buses through circuit breakers marked **CPLT WSHLD ANTI-ICE** and **PILOT WSHLD ANTI-ICE** respectively. On helicopters equipped with center windshield anti-ice system, control circuit breakers for pilot's and center windshield are on the No. 2 dc primary bus and are marked **WINDSHIELD ANTI-ICE PILOT** and **CTR**. If the APU generator is the sole source of ac-generated power, the backup pump and the windshield anti-ice cannot be used simultaneously.

2.53 PITOT HEATER.

Pitot tube heat is provided by heating elements within each pitot tube head. Power to operate both heating elements is controlled by a single switch on the upper console, marked **PITOT HEAT OFF** and **ON**. When the switch is placed **ON**, current flows to the heating elements. Current sensors in the circuits sense the current flow and keep the caution lights, marked **LFT PITOT HEAT** and **RT PITOT HEAT**, turned off. If a heating element fails, the current sensor will detect no current flow, and turn on the caution light for that pitot tube. Power to operate the pitot tube heaters is provided from the No. 2 ac primary bus for the right pitot tube, through a circuit breaker marked **RT PITOT HEAT**, and from the No. 1 ac primary bus for the left pitot tube, through a circuit breaker marked **LEFT PI-**

TOT HEAT. Power to operate the caution lights is provided from the No. 1 dc primary bus through a circuit breaker, marked **NO. 1 ENG ANTI-ICE.**

2.54 ROTOR BLADE DEICE KIT.



Blade deice operation with erosion strips installed may cause blade damage.

The rotor blade deice kit (Figure 2-18) consists of the following: deice control panel, deice test panel, system controller, power distributor, main and tail sliprings, main and tail blade heating elements, droop stop heaters, caution lights, outside air temperature (OAT) sensor, a modified ambient temperature sense line and an icing rate meter subsystem. The blade deice system provides improved mission performance in icing conditions by applying controlled electrical power to integral heating elements in the main and tail rotor blades, causing the ice bond layer to melt, allowing symmetrical ice shedding. Droop stop heaters apply heat to the droop stop hinge pins, to prevent icing and permit proper operation. The heaters are electrically powered continuously whenever the blade deice system is operating, either with the power switch **ON**, or the system in the **TEST** mode. The blade deice system, excluding element-on-time (EOT) failure, may be ground checked using the APU generator. To prevent generator overload when only the APU generator is operating, an interlock system is installed to inhibit blade deice test if the backup pump is operating. If the backup pump should go on during the test cycle, the **MR DE-ICE FAIL** caution light will go on immediately, alerting the crew to an invalid test attempt. The test cycle must then be initiated again. The OAT sensor, installed below the windshield, provides a signal to the controller for heating EOT of the rotor blades. The lower the OAT, the longer EOT will be. To reduce power requirements, the blades are deiced in cycles. Power to operate the blade deice is provided from the No. 1 and No. 2 ac primary buses and No. 2 dc primary bus through circuit breakers, marked **ICE-DET**, **DE-ICE CNTRLR**, and **DE-ICE PWR TAIL ROTOR**, on the mission readiness circuit breaker panel in the cabin. Main blade deice power is routed through current limiters in the deice junction box. When one main generator is inoperative, deice power can be supplied by the APU generator.

2.54.1 Blade Deice System Operation. The ice detector is operational anytime power is applied to the heli-

copter. The ice detector senses ice accumulation on a vibrating probe by a change in probe frequency. The frequency change is processed by the ice rate meter. The ice rate meter provides a visual display of icing intensity, T (trace), L (light) blue, M (moderate) yellow, and H (heavy) red. Also, the ice rate meter sends a signal to the **ICE DETECTED** caution light when the **BLADE DE-ICE POWER** switch is off, informing the pilot of the requirement to turn on the system. When the system has been turned on by placing the **POWER** switch **ON**, the ice detector aspirator heater is turned on, and the **ICE DETECTED** caution light is turned off. If the **MODE** switch is at **AUTO**, the rate meter sends an ice rate signal to the controller. The controller processes the ice rate signal to produce heater element-off-time, and the OAT signal to produce the heater EOT. The controller sends command signals through the main rotor sliprings to the system distributor which responds to controller signals by switching power in sequence to the main rotor blade heater zones. Tail rotor blade power is switched directly by the controller and sent through the tail rotor sliprings to the tail rotor blades. A tail blade distributor is not required since the power is applied to the four tail blades simultaneously. The deice control panel contains a rotary switch which allows automatic or manual control of blade heater element-off-time. In **AUTO** (automatic), the ice rate signal is passed on to the controller, which results in off-time variations proportional to the ice rate. In **MANUAL**, **T**, **L**, or **M**, fixed signals are transmitted to the controller, resulting in fixed element-off-time. Ice rate subsystem malfunctions are indicated by the appearance of a **FAIL** flag on the rate meter face, requiring operation of the blade deice system in one of the three manual modes. **MANUAL** mode should also be used when the rate meter has no indicated malfunction, but any of these three conditions has occurred: 1. Pilot has determined by his judgment of ice intensity that the ice rate system is inaccurate. 2. Torque required has increased to an unacceptable level. 3. Helicopter vibration has increased to an unacceptable level. During a single main generator failure, blade deice will be dropped until the APU is started and the **APU** generator switch is placed **ON**. Even though the **APU** generator switch is **ON** and providing power to the blade deice system, the **APU GEN ON** advisory light will not be on because of one main generator operating.

2.54.2 Blade Deice System Control Panel. All controls for operating the rotor blade deice system are on the

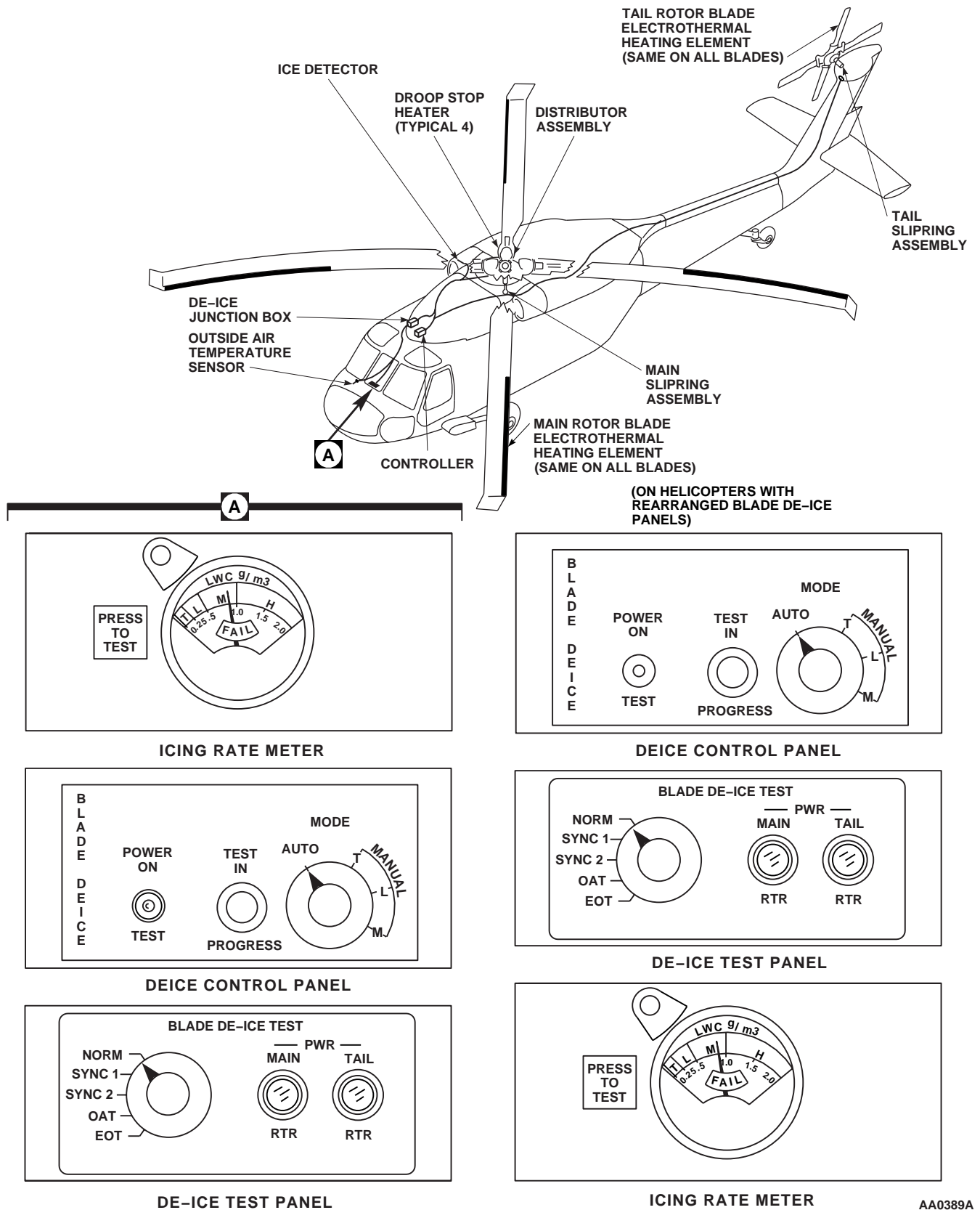

Figure 2-18. Rotor Blade Deice Kit

BLADE DEICE system control panel (Figure 2-18). Controls are described as follows:

CONTROL/ INDICATOR	FUNCTION
POWER switch TEST	Electrically test main and tail rotor deice system for one test cycle.
ON	Turns on power to blade deice controller and turns off ICE DETECTED caution light.
OFF	Turns off deice system.
TEST IN PROGRESS	Green light goes on during test cycle. At end of test cycle, light should go off.
MODE selector AUTO	System off-time is controlled by ice rate signal.
MANUAL	Gives pilot manual control of system off-time.
T	Sets a fixed element-off-time for trace icing.
L	Sets a fixed element-off-time for light icing.
M	Sets a fixed element-off-time for moderate icing.

2.54.3 Blade Deice Test. The **BLADE DE-ICE TEST** panel (Figure 2-18) allows the pilot to check the blade deice system for failures that are otherwise dormant during the normal **TEST** mode, but that can allow abnormal operation during use. The panel accomplishes this by introducing selected failure signals into the system and requiring the deice controller built-in-test circuitry to function in a specific manner. The blade deice test should be done during the ground checkout before each flight when blade deice use is anticipated. In the **NORM** position, the test panel allows system test to be done without the introduction of false failure signals. Thus, the system should complete its self checkout cycle without failure indications on the caution panel. In the **SYNC 1** and **SYNC 2** positions, the test panel interrupts the distributor sync line and provides the

controller with a false sync input. The controller must interpret these false signals as indications of distributor failure, and produce **MR DE-ICE FAIL** caution light for both cases. In the **OAT** position, the test panel short circuits the OAT sensor input to the controller. BITE circuitry within the controller must sense the simulated failure and turn on both the **MR DE-ICE FAIL** and **TR DE-ICE FAIL** caution lights. In the **EOT** position, the test panel biases BITE circuitry in the controller and the OAT sensor to simulate malfunctioning primary EOT timing circuits. The biased BITE circuit is thus deceived into believing that the primary circuits are in error. The controller must turn on both the **MR DE-ICE FAIL** and **TR DE-ICE FAIL** lights when this occurs. The test panel also functions automatically during blade deice system use to sense contradictory signals from the deice power circuits. If electrical power remains applied to either the main or tail rotor heating elements after the controller signals a **FAIL** condition or when the system is **OFF**, then the corresponding **PWR** monitor light on the **BLADE DE-ICE TEST** panel turns on. The light informs the crew that further action is required to isolate the deice loads indicated. The test panel provides a reliability check of critical deice system functions. The pilot, after doing the indicated tests properly, can be confident that the deice system primary and BITE electronics are functioning within specified tolerances.

2.54.4 Blade Deice Test Panel. The control for selecting test functions of the blade deice system is on the **BLADE DE-ICE TEST** panel (Figure 2-18). Two **PWR** lights on the panel warn of power malfunctions of the main and tail rotor deice. Control and indicators are as follows:

CONTROL/ INDICATOR	FUNCTION
NORM	Provides a signal path for normal operation.
SYNC 1	Provides a signal to the controller to verify operation of synchronization check circuitry when POWER switch is at TEST .
SYNC 2	Provides an open circuit to the controller to verify operation of synchronization check circuitry when POWER switch is at TEST .

CONTROL/ INDICATOR	FUNCTION
OAT	Short circuits the OAT sensor to check BITE circuit sensing a fault when POWER switch is at TEST .
EOT	Disables BITE circuits in controller and OAT sensor to simulate a malfunctioning primary EOT timing circuit when POWER switch is ON and MODE select switch is at M (moderate).
PWR MAIN RTR light	Indicates a malfunction has occurred in the main rotor primary power.
PWR TAIL RTR light	Indicates a malfunction has occurred in the tail rotor primary power.

2.55 BLACKOUT CURTAINS.

Curtains are provided to cover the cabin windows and the opening between the pilot’s compartment and the cabin. Velcro tape is bonded to the cabin structure and the curtains with an adhesive. Loops are attached to the curtains to aid removal.

2.56 WIRE STRIKE PROTECTION SYSTEM.

On helicopters equipped with wire strike protection provisions, the system (Figure 2-1) is a simple, lightweight, positive system with no motorized or pyrotechnic components used to cut, break, or deflect wires that may strike the

helicopter in the frontal area between the tires and fuselage, and between the fuselage and main rotor in level flight. The system consists of nine cutters/deflectors located on the fuselage and landing gear/support. They are: upper cutter on the rear of the sliding fairing, the pitot cutter/deflector on the front of the sliding fairing, windshield post and wiper deflectors, door hinge deflector, step extension and step deflector, landing gear joint deflector, main landing gear cutter/deflector, and tail landing gear deflector.

2.57 FLIGHT DATA RECORDER (ON HELICOPTERS EQUIPPED WITH FLIGHT DATA RECORDER KIT).

The flight data recorder system installed in the aft transition avionics compartment is a crash survivable digital tape recorder providing 25 hours of recorded data on a continuous loop magnetic tape. Flight data input to the recorder is sent from different locations throughout the helicopter. The recorder begins to record data as soon as ac and dc essential power is supplied to the helicopter. Electrical power to operate the data recorder system is provided from the dc essential bus and ac essential bus through circuit breakers marked **FLT REC** on the mission readiness circuit breaker panel. There are no controls provided to the pilot or copilot for control of the recorder.

2.58 DATA COMPARTMENTS.

Data Compartments are on each cockpit door (Figure 2-4).

2.58A SNOW SKIS.

The skis for the UH-60A/L are designed to keep the aircraft from becoming immobile when operating on snow (winter) and tundra (summer).

Section X HEATING, VENTILATING, COOLING, AND ENVIRONMENTAL CONTROL UNIT

2.59 HEATING SYSTEM.

The subsystem consists of a heated air source, cold air source, mixing unit, temperature sensing unit, overtemperature sensor, controls, ducting and registers. The heating system is a bleed-air system and bleed-air supplied in flight by the main engines, and on the ground by the main engines or the APU. An external connector allows connection of an external ground source in to the pneumatic system, that can provide heat when connected. Power to operate electrical components of the heating system is by the No. 1 dc primary bus through a circuit breaker, marked **AIR SOURCE HEAT/START**.

2.59.1 Winterized Heater. The winterized heater consists of a high bleed-air flow mixing valve and a modulation valve. The mixing valve is of enough capacity to keep the interior temperature of the helicopter at 4°C (39°F), to ambient temperatures down to -54°C (-65°F). The mixture sensor controls air mixing to allow control of temperature used for cabin heat. Bleed-air is mixed with ambient air to get the desired temperature selected by the variable temperature control on the **HEATER** control panel (Figure 2-7). Bleed-air is regulated with the modulation valve for downstream mixing with ambient air when the **HEATER** control switch is **ON**. Overtemperature is prevented by two overtemperature sensors that deenergize solenoid valves when bleed-air temperature reaches about 90° to 96°C (194° to 205°F) at the inlet to the mixing valve or in the mixing chamber. The temperature sensors control current flow to the on-off solenoid and the winterization solenoid to hold them energized, allowing bleed-air to flow to the mixing chamber. When the **ENG ANTI-ICE** switch is placed **ON** or a dc power failure occurs, the winterization solenoid will deenergize. An interlock system between engine anti-ice system and the heater winterization solenoid valve prevents engine overbleed by reducing bleed-air flow to the heater when an **ENG ANTI-ICE** switch is **ON**. Operation of the winterization heating system is the same as in Paragraph 2.59.3.

2.59.2 Heat and Ventilation Controls. A variable control air mixing valve assembly is used to control the temperature of air for cabin heating in the helicopter. Bleed-air from the engine, APU, or external source is mixed with ambient air to obtain the desired temperature determined by the setting of the sensor in the downstream air flow. Regulation of the diaphragm position is by a solenoid. Should the **HEATER** control switch (Figure 2-7) be turned **OFF**, or dc power fail, bleed-air will shut off. The valve

also has a thermal protective switch that deenergizes the solenoid if mixed air temperature is over 90° to 96°C (194° to 205°F). The mixture temperature sensor downstream of the mixing valve regulates flow output temperature. The sensor is regulated from the cockpit through a control linkage at the overhead console. The temperature control is marked **HEATER OFF, MED, and HI**. Ventilation is controlled through a panel on the upper console marked **VENT BLOWER**. When the switch is placed **ON**, dc power to the solenoid allows bleed-air to mix with outside air.

2.59.3 Normal Operation.

1. APU or engine - Start (Refer to paragraph 8.22 or 8.23).
2. **AIR SOURCE HEAT/START** switch - As required. **ENG** if engine is operating; **OFF** for heat from external air source.
3. **HEATER ON-OFF** switch - **ON**.
4. **VENT BLOWER** switch - **OFF** for maximum heat.
5. **HEATER** control - As desired.

2.60 VENTILATION SYSTEM.

2.60.1 Ventilation System. UH The helicopter is ventilated by an electrically-operated blower system controlled through the **VENT BLOWER** control panel on the upper console (Figure 2-7). The **VENT BLOWER** switch is marked **OFF** and **ON**. When **ON**, the blower forces ambient air into the cabin ducts. The No. 2 ac primary bus powers the blower through a circuit breaker, marked **HEAT & VENT**. It is also controlled by dc power from the No. 2 dc primary bus through the **VENT BLOWER** switch protected by a circuit breaker, marked **HEAT VENT**. Ram air vents for cooling the cockpit area are on each side of the upper console and at the front of the lower console (Figure 2-4) and are controlled by turning the nozzle to control the opening.

2.60.2 Ventilation System. EH In addition to the standard ventilation system, the EH-60A has a ventilation system which operates in conjunction with the air conditioning system. The system is controlled from the **ECS** control panel on the upper console (Figure 2-7). When the **AIR COND** switch is placed in the **FAN** position, fresh air

is drawn from outside the helicopter into the plenum chamber, mixed with inside air and circulated through the helicopter.

2.60.3 Normal Operation.

1. APU, rotor or external power - Operating.
2. **VENT BLOWER** switch - ON.

2.61 Air Conditioner System. **EH** The vapor-cycle system (air conditioner) cools the cabin and cockpit areas. It consists of a heli-rotor compressor, evaporator, condenser, associated valves, protective pressure and temperature switches, a filter, service valves, a liquid indicator and an electrical control system. A sight glass in the liquid line gives an indication of refrigerant liquid servicing level, when the system is operating. The temperature controller assembly, in the aft cabin, processes the input signals from the temperature selection rheostat in the cockpit and the cabin temperature sensor, and provides the power to the hot gas bypass valve solenoid. The electrical control box, in the transition section, contains the relays, time delays, elapsed time meter and fault indicators for the vapor-cycle system. The control box routes the power to the electrical components. Inputs from the remote control and temperature controller are channeled to their respective electrical interface in the control box. Across the front of the enclosure are four fault indicators **HI** and **LO PRESS**, and **HI** and **LO TEMP**, which are tripped to indicate red when a fault is received. These indicators provide visual signals of a fault occurring, even if it is only temporary, and they can be

manually reset for reuse by pressing in the fault indicator. The air conditioner system is protected to prevent evaporator freezing. The system may be operated at any ambient temperature without causing damage, shown in Table 2-2. Power to operate the air conditioner system is provided from the No. 2 ac primary bus and controlled from the No. 1 dc primary bus through a breaker marked **ECS CONTR**. Control of the air conditioner is through the **ECS** control panel on the upper console (Figure 2-7). The panel contains a temperature control rheostat with an increasing arrow indicator to **COOL**, two mode selection switches marked **COOL-OFF-FAN** and **HTR-OFF-ON**. The temperature control rheostat is used with the **COOL** switch to set the desired cabin temperature. Placing switch to **COOL** will cause **AIR COND ON** advisory light to illuminate. Selection of the **COOL** mode on the cockpit **AIR COND** control panel starts a phased sequence of events leading to full operation of the air conditioner system. To prevent a sudden surge in 115 vac power, the major electrical components are started at spaced intervals.

2.62 AUXILIARY HEATER SYSTEM. **EH**

Incorporated in the air conditioner plenum chamber is an auxiliary heating system to supplement the bleed air heater. The electrically operated heater is controlled by a switch on the upper console **ECS** control panel marked **HTR ON & OFF**. The heater element will operate continuously as long as the switch is **ON**. With the **HTR** switch **ON** and the **AIR COND** switch placed in the **FAN** position the **CABIN HEAT ON** advisory light will illuminate. An overtemperature protection is provided at 205°F if there is a heater malfunction.

Table 2-2. Air Conditioning System Power Source Priority **EH**

POWER SOURCE	AIR CONDITIONING SYSTEM OPERATION
APU Generator (Aircraft on Ground)	<ul style="list-style-type: none"> •Air Conditioning Interrupted if: <ul style="list-style-type: none"> (1) Backup Pump is On. or (2) Windshield Anti-Ice is On. •Windshield Anti-Ice Interrupted when Backup Pump is On.
APU Generator (Aircraft in Flight)	<ul style="list-style-type: none"> •Air Conditioning Interrupted while Aircraft in Air. •Windshield Anti-Ice Interrupted when Backup Pump is On.
Dual Main Generator (No. 1 and No. 2) (Aircraft in Flight or on Ground)	<ul style="list-style-type: none"> •Air Conditioning, Backup Pump, and Windshield Anti-Ice can Operate Simultaneously.
Single Generator or External AC Power (Weight on or off Wheels)	<ul style="list-style-type: none"> •Air Conditioning Interrupted If: <ul style="list-style-type: none"> (1) Backup Pump is On.

Section XI ELECTRICAL POWER SUPPLY AND DISTRIBUTION SYSTEMS

2.63 ELECTRICAL POWER SYSTEMS.

Alternating current (ac) is the primary source of power. The primary electrical system consists of two independent systems, each capable of supplying the total helicopter power requirements. The prime source of each system is a 115/200 vac generator. A subsystem feeds two independent ac primary buses and an ac essential bus. A portion of each ac primary bus load is converted to 28 volts direct current (vdc) by two 200 ampere ac/dc converters. The 28 vdc is distributed by two independent dc primary buses and a dc essential bus. Emergency power is provided by a generator driven by the auxiliary power unit (APU). The APU generator is capable of supplying all flight-essential ac and dc bus loads. In addition, the APU generator can supply power to the blade deice system (when installed) if one main generator should fail. Should a second generator fail, the blade deice load will be dropped and the APU generator will power the remaining ac bus loads. An electric power priority feature allows either the No. 1 or No. 2 main generator to automatically supersede the APU generator, which, in turn, automatically supersedes external power. A 24-volt battery provides backup dc power.

2.64 DC POWER SUPPLY SYSTEM.

Primary dc power is obtained from two converters (transformer-rectifiers) with a battery as the secondary power source. There is no external dc power connector (Figure 2-19).

2.64.1 Converters. Two 200-ampere converters, each normally powered by the No. 1 and No. 2 ac primary buses respectively, turn ac power into dc power and reduce it to 28 volts. The converter output is applied to the No. 1 and No. 2 dc primary buses whenever ac power is applied to the ac primary buses. If one converter's output is lost, the converter load will be transferred to the operating system, and a caution light, marked #1 CONV or #2 CONV will go on. Power to light the caution light is provided by the battery bus through a circuit breaker marked, **AC CONV WARN**.

2.64.2 Battery.

a. A 24-volt dc 5.5 ampere hour 20-cell nickel cadmium (nicad) battery provides secondary or emergency dc power. The battery is in the cabin section behind the copilot. It supplies dc power to the battery and battery utility buses (Figure 2-19) for operating dc essential equipment during primary dc malfunction. Power to the battery bus is controlled by the **BATT** switch on the upper console. It has marked positions **OFF** and **ON**. The battery utility bus is

connected directly to the battery. During No. 1 and No. 2 dc primary source malfunction, the dc essential bus is powered by the battery bus as long as the battery is at least 35% charged and the **BATT** switch is **ON**. When only battery power is available, the battery life is about 22 minutes day and 14 minutes night for a battery 80% charged. The **BATT** switch should be **ON** when either external power, APU generator or main generator power is applied to the helicopter. This will recharge the battery. When the battery is the sole source of dc power, the **BATT** switch should be turned **OFF** immediately upon obtaining a **BATT LOW CHARGE** caution light. A malfunction of both dc primary sources will light caution lights marked #1 and #2 CONV. If the **BATT** switch is left **ON**, the battery will be completely discharged in less than 3.5 hours. If the maintenance light and both cockpit utility lights are left on, the battery will be completely discharged in less than 7 hours. Power to light the caution light is from the battery bus through a circuit breaker marked **BATT & ESNTL DC WARN EXT PWR CONTR**.

b. A 24-volt dc 9.5 ampere hour sealed lead acid battery (SLAB) provides secondary or emergency dc power. The battery is in the cabin section behind the copilot. It supplies dc power to the battery bus, battery utility bus and dc essential bus (Figure 2-19) for operating dc essential equipment during primary dc malfunction. Power to the battery bus is controlled by the **BATT** switch on the upper console. It has marked positions **OFF** and **ON**. The battery utility bus is connected directly to the battery. The dc essential bus is powered by the battery bus as long as the **BATT** switch is **ON**. When only battery power is available, the battery life is about 38 minutes day and 24 minutes night for a battery 80% charged. The **BATT** switch should be **ON** when either external power, APU generator or main generator power is applied to the helicopter. This will recharge the battery. When the battery is the sole source of dc power, the **BATT** switch should be turned **OFF** immediately upon obtaining a **BATT LOW CHARGE** caution light. This is done so that battery power can be conserved for an APU start. A malfunction of both dc primary sources will light caution lights marked #1 and #2 CONV. If the **BATT** switch is left **ON**, the battery will be completely discharged in less than 6 hours. Power to light the **BATT LOW CHARGE** caution light is from the battery bus through a circuit breaker marked **BATT & ESNTL DC WARN EXT PWR CONTR**.

2.64.3 DC Monitor Bus.  The dc monitor bus is normally energized by the No. 1 and No. 2 converters when the generators are operating, and is powered by the No. 2 converter when operating from external power (Figure

UH60 ELECTRICAL SYSTEM

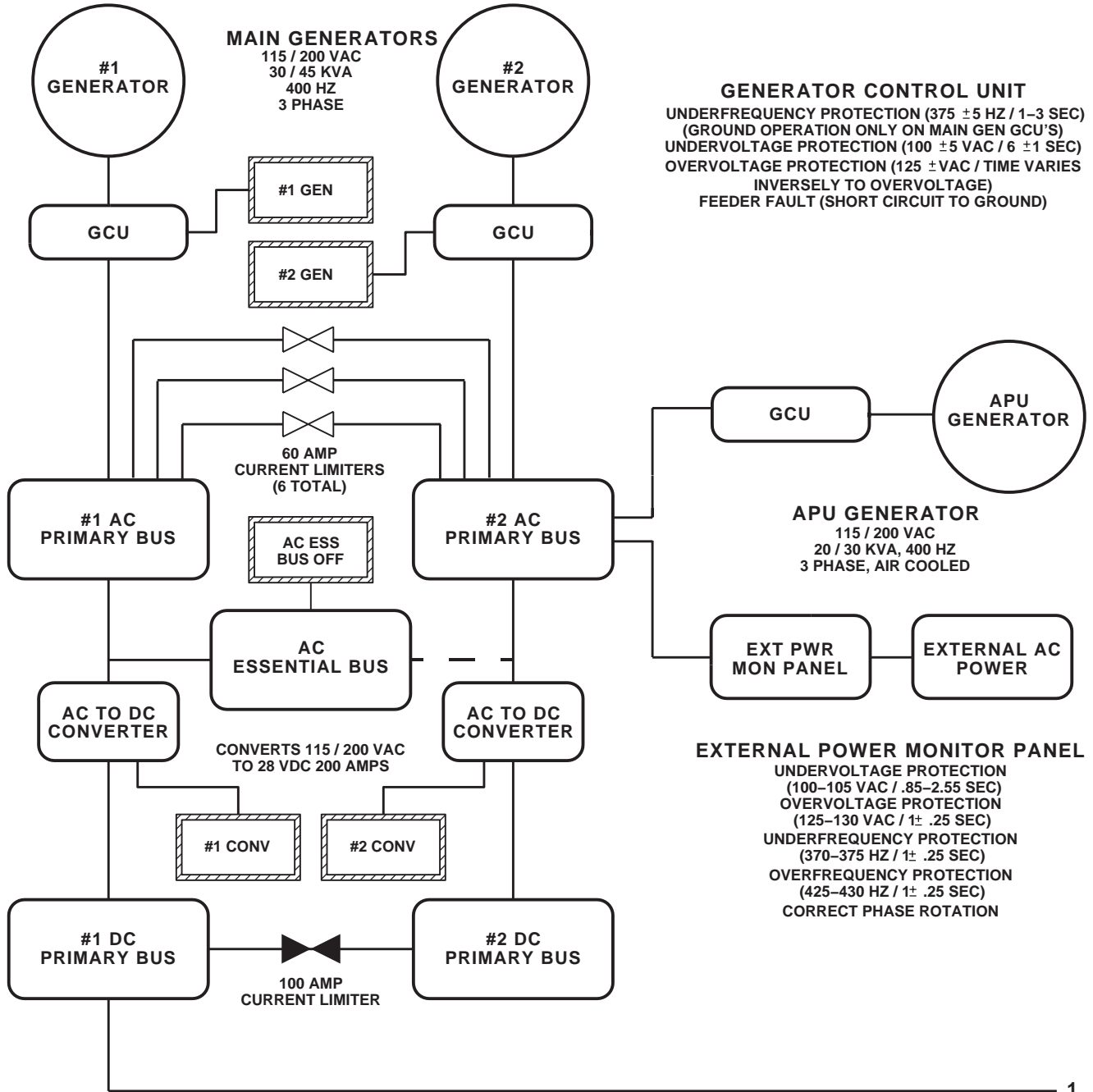

1

AA0327_1
SA

Figure 2-19. Electrical System (Sheet 1 of 2)

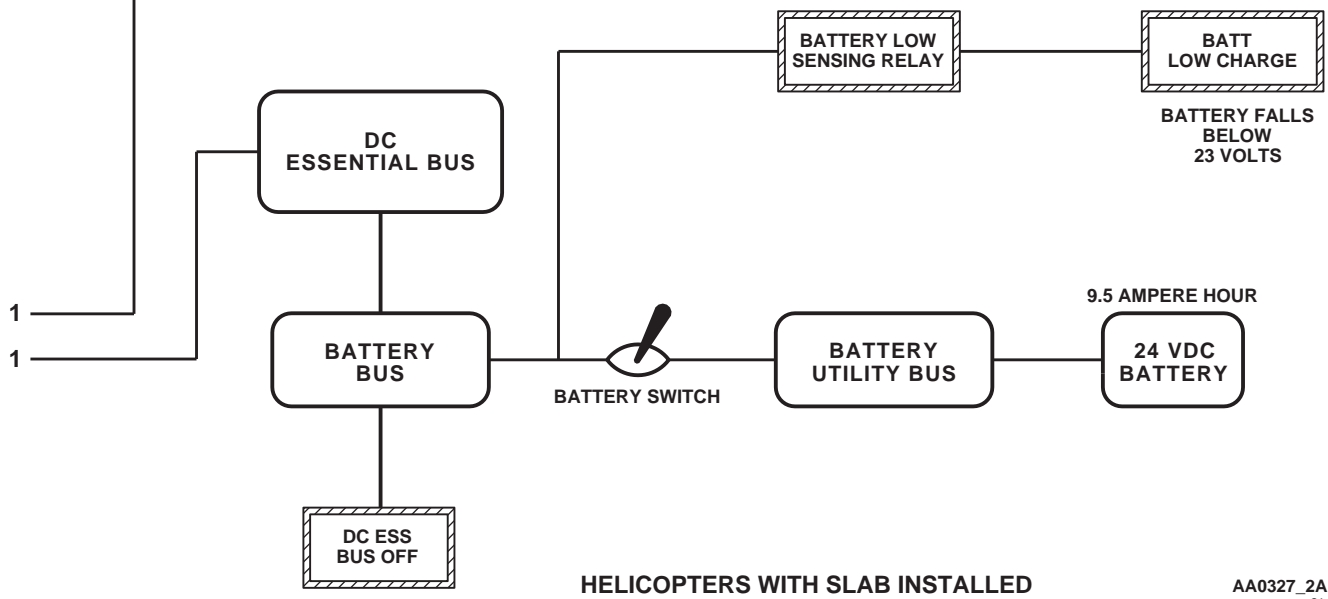
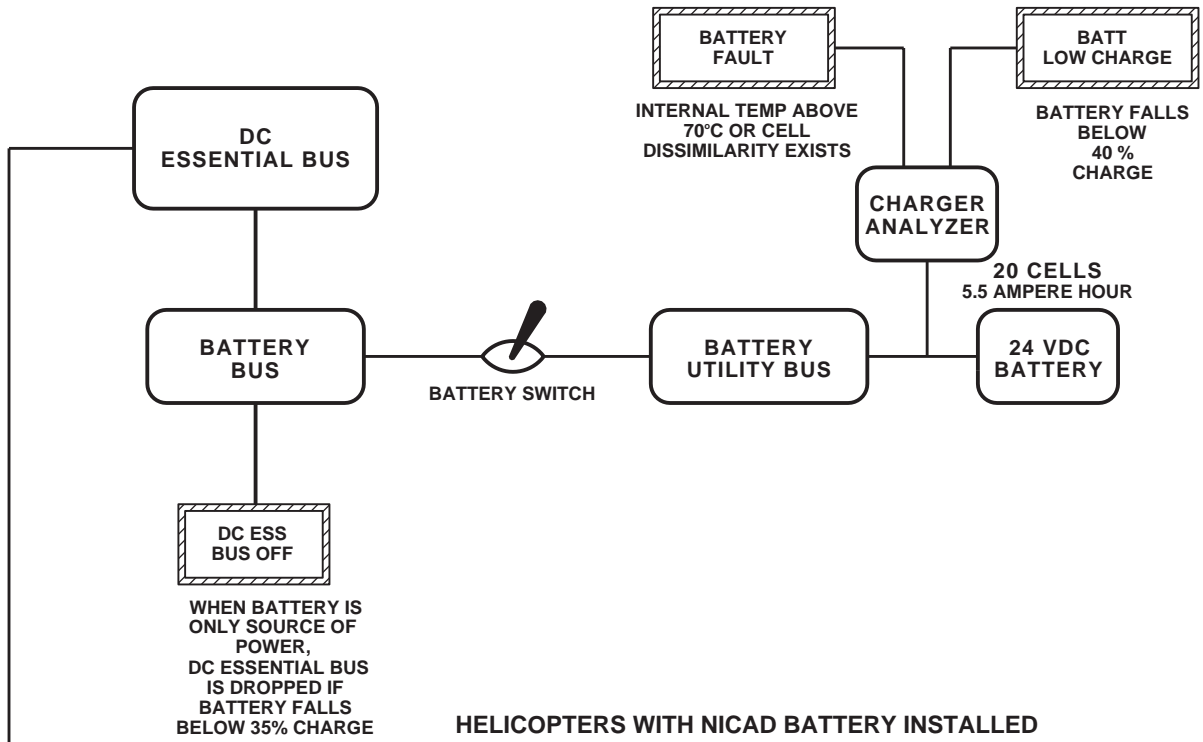

AA0327_2A
SA

Figure 2-19. Electrical System (Sheet 2 of 2)

2-19). If either converter should fail, the bus will be automatically dropped from the system.

2.64.4 Quick Fix Power. **EH** Mission equipment dc power is provided from the No. 1 dc primary bus, and is controlled by **Q/F PWR** switch on the upper console.

2.64.5 Battery Charger/Analyzer. A charger/analyzer system restores the battery charge and determines the condition of the battery. The system charges the battery through a converter whenever ac power is available on the helicopter and the **BATT** switch is **ON**. The analyzer system monitors battery charge and lights a caution light indi-

cating **BATT LOW CHARGE** when the charge lowers to 35% to 45% of battery capacity. If battery charge continues to lower, at 30% to 40% of battery capacity, the dc essential bus will be disconnected from the battery. At 35% capacity the battery can provide two APU starts. Another analyzer circuit monitors battery temperature. When the internal temperature reaches 70°C (158°F), or if a battery cell dissimilarity condition exists, a caution panel light will go on, indicating **BATTERY FAULT** (only on helicopters equipped with nickel-cadmium batteries). Then the charger/analyzer should automatically disconnect the battery from the charging circuit. As a backup, placing the **BATT** switch

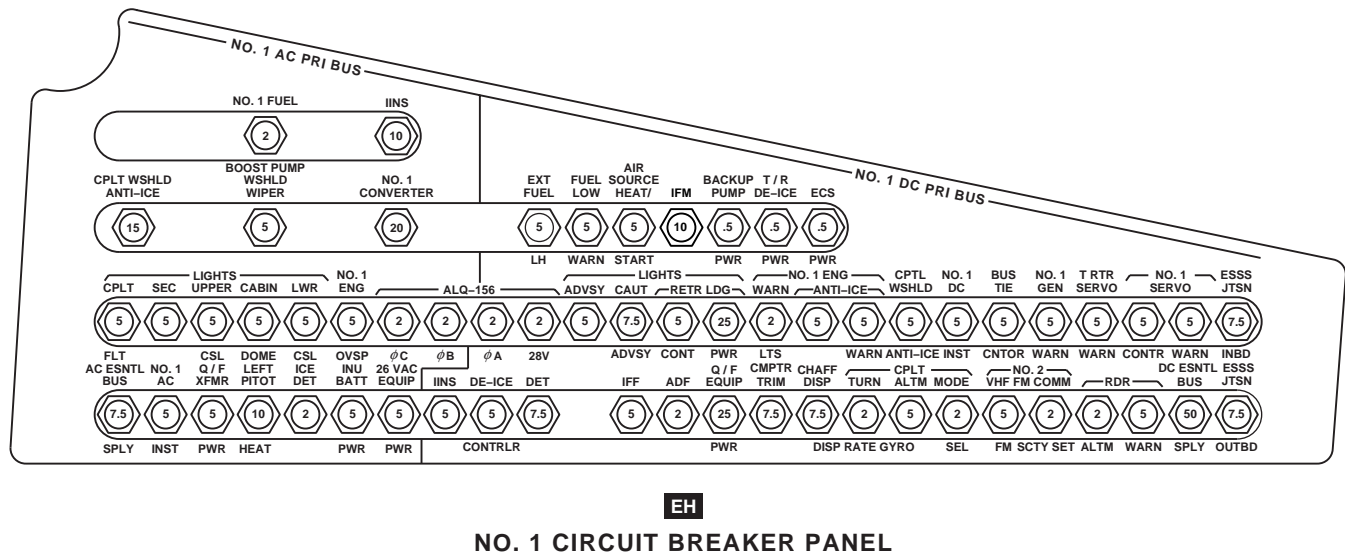
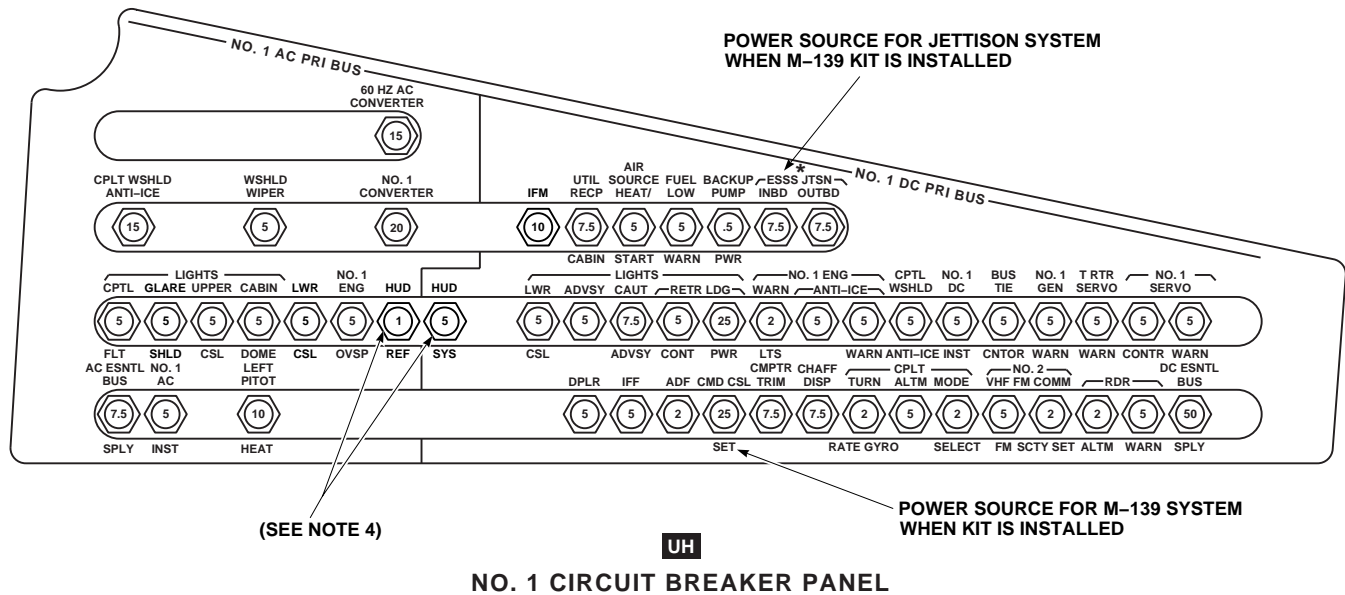

- NOTES**
- ON HELICOPTERS PRIOR TO SERIAL NO. 81-23579 NOT MODIFIED BY MWO 55-1520-237-50-25.
 - ON HELICOPTERS PRIOR TO SERIAL NO. 81-23579 MODIFIED BY MWO 55-1520-237-50-25 AND HELICOPTERS SERIAL NOS 81-23579 AND SUBSEQUENT.
 - CIRCUIT BREAKERS WITH ASTERISK (*) ARE ON HELICOPTERS SERIAL NOS 82-23748 AND SUBSEQUENT.
 - ON HELICOPTERS MODIFIED BY MWO 1-1520-237-50-62, HUD.
 - ON HELICOPTERS SERIAL NOS 97-26744 AND SUBSEQUENT.

Figure 2-20. DC and AC Circuit Breaker Panels (Typical) (Sheet 1 of 4)

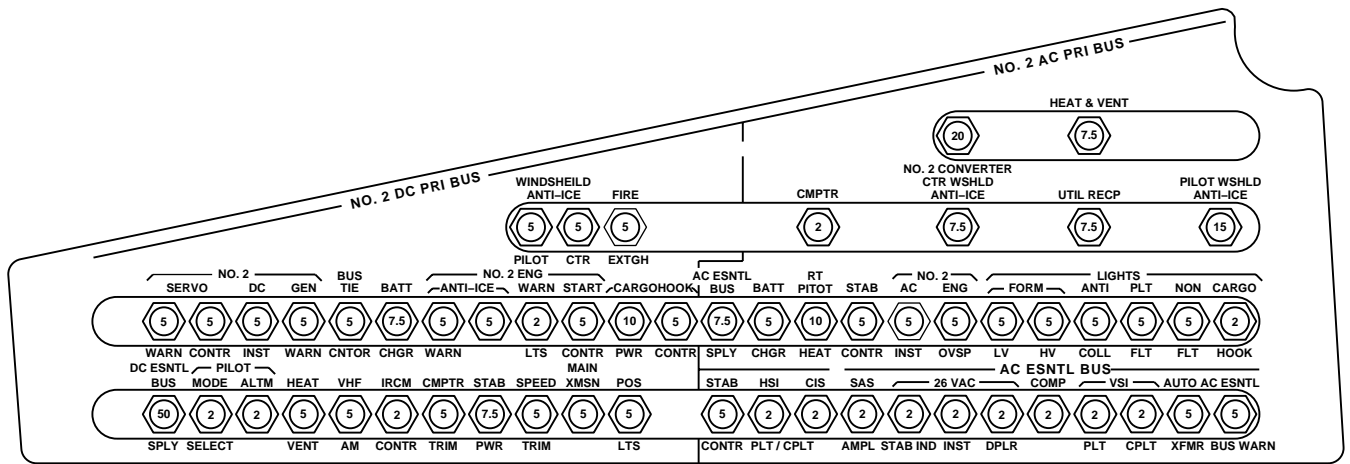

UH

NO. 2 CIRCUIT BREAKER PANEL

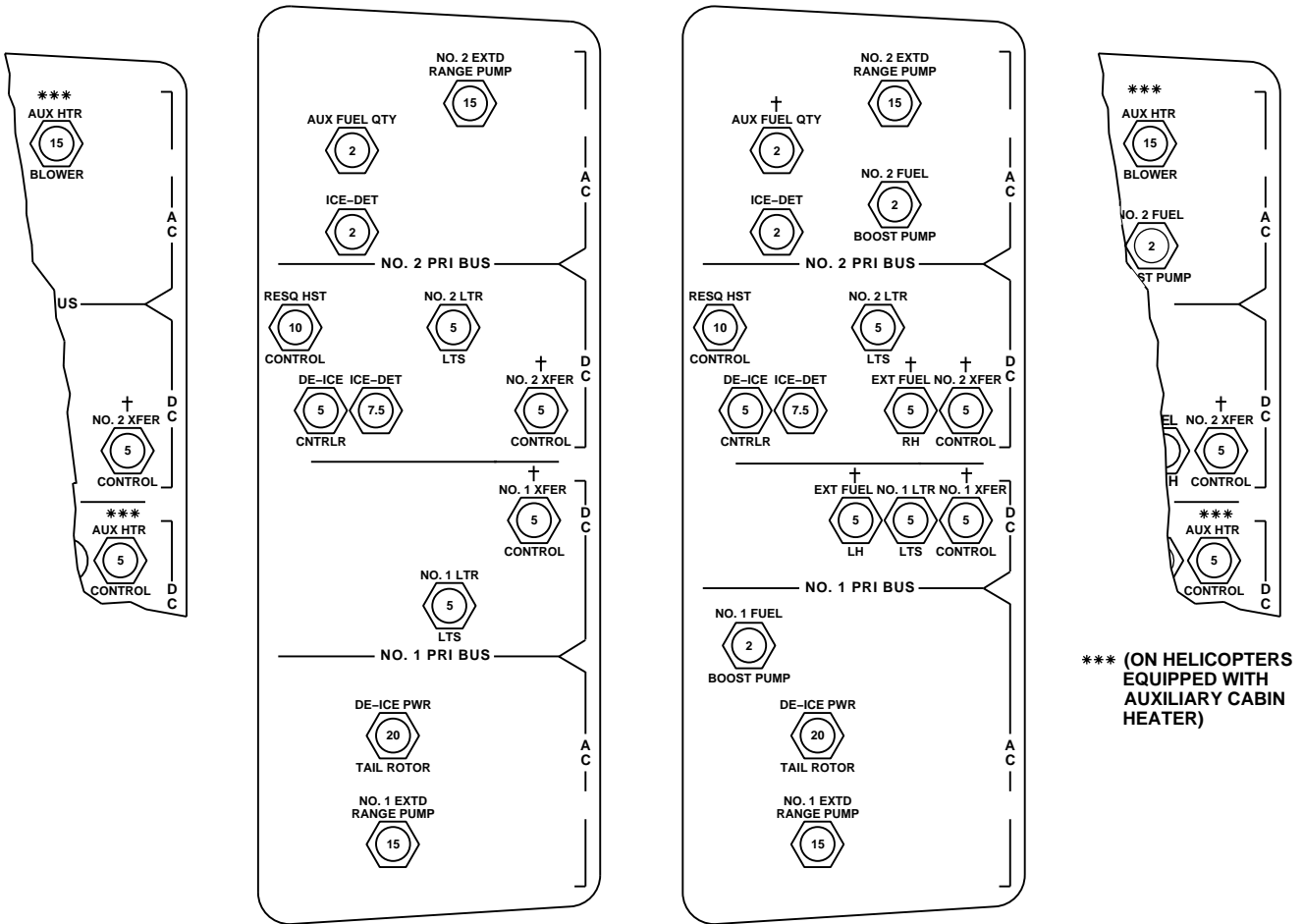

(SEE NOTE 1)

† = ES

(SEE NOTES 2 AND 3)

UH

MISSION READINESS
CIRCUIT BREAKER PANELS (CABIN)

*** (ON HELICOPTERS
EQUIPPED WITH
AUXILIARY CABIN
HEATER)

AA0353_2A
SA

Figure 2-20. DC and AC Circuit Breaker Panels (Typical) (Sheet 2 of 4)

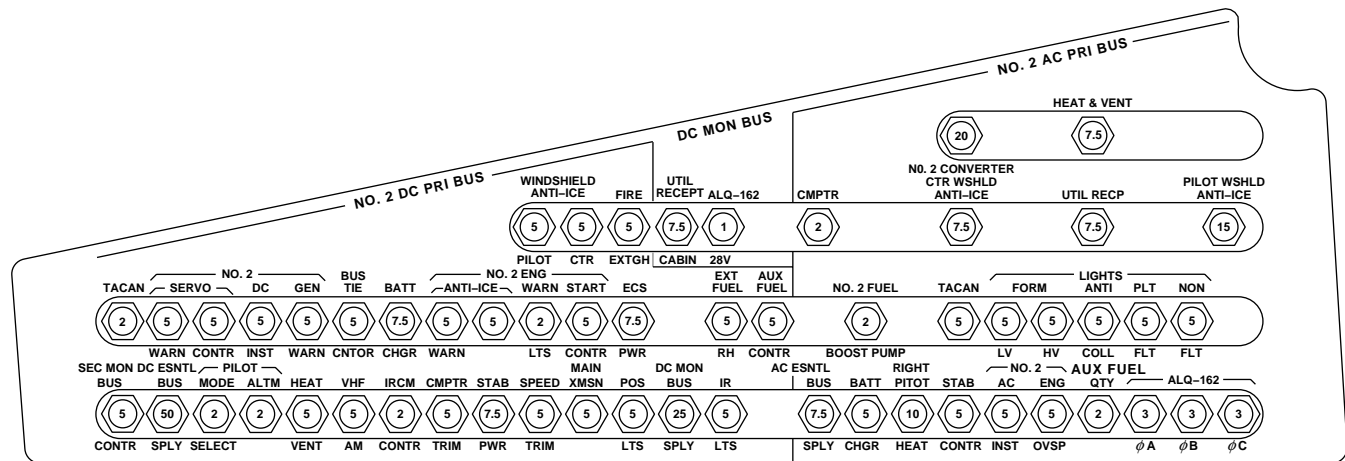

PILOT'S CIRCUIT BREAKER PANEL

AA0353_3B
SA

Figure 2-20. DC and AC Circuit Breaker Panels (Typical) (Sheet 3 of 4)

OFF removes input power to the charger/analyzer. By placing **BATT** switch **OFF**, the increasing temperature may be checked.

2.64.6 Battery Low Sensing Relay. On helicopters equipped with the sealed lead acid battery the system charges the battery through the battery charging relay with one or both converters on. A caution light indicating **BATT LOW CHARGE** lights when voltage on the battery utility bus drops below 23 vdc.

2.64.7 DC and AC Circuit Breaker Panels. The circuit breaker panels (Figure 2-20) protect the power systems. One is above and to the rear of each pilot and copilot, one is on the lower console, and two are on the upper console. The ac essential bus contains one additional panel. The circuit breakers provide both ac and dc protection. Popping of a circuit breaker indicates too much current is being drawn by a component in the circuit that is powered through the circuit breaker. Unnecessary recycling of circuit breakers, or using circuit breakers as a switch should not be done.

2.65 AC POWER SUPPLY SYSTEM.

A primary ac power system (Figure 2-19) delivers regulated three phase, 115/200 vac, 400 Hz. Each system contains a 30/45 kilovolt-ampere generator mounted on and driven by the transmission accessory gear box module, a current transformer, a generator control unit, and current limiter, all of which are interchangeable. System outputs are applied to the No. 1 and No. 2 ac primary buses. Caution lights will go on, indicating **#1 GEN** or **#2 GEN** whenever generator output is interrupted. Another caution light goes on, indicating **AC ESS BUS OFF** when there is no power to the ac essential bus. Individual generator controls are provided on the upper console (Figure 2-7), with marked positions of **TEST**, **OFF/RESET**, and **ON**. A generator main bearing caution system is installed on each main generator to light a caution light, marked **#1 GEN BRG** or **#2 GEN BRG**, to indicate a worn or failed bearing. The caution light will remain on until power is removed. The auxiliary bearing will allow 10 additional hours of operation after the light goes on. Therefore, it should not be a cause for mission abort. Power to operate the caution

POWER SOURCE FOR EMERGENCY
JETTISON SYSTEM WHEN M-139
KIT IS INSTALLED

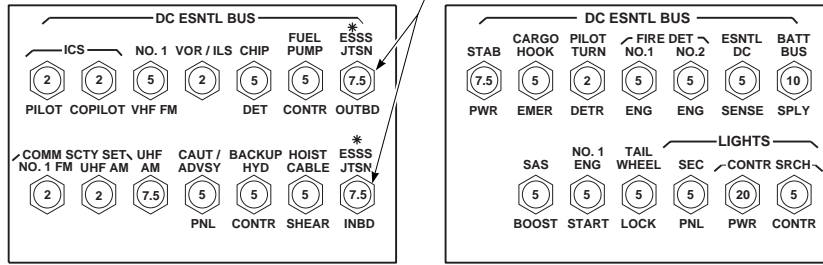

UPPER CONSOLE CIRCUIT BREAKER PANEL

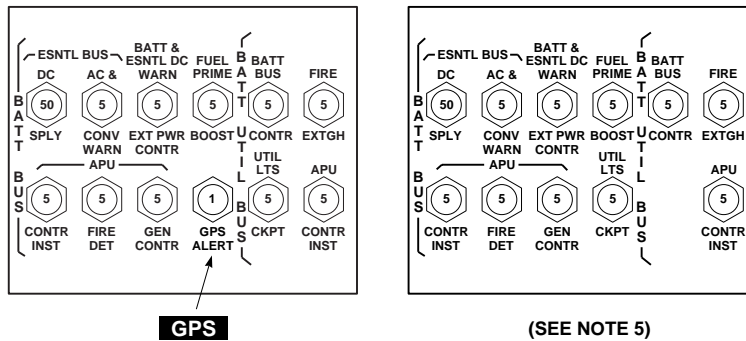

GPS

(SEE NOTE 5)

BATTERY AND BATTERY UTILITY
BUS CIRCUIT BREAKER PANEL

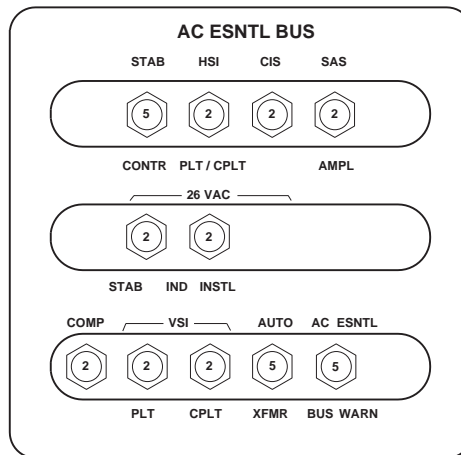

AC ESSENTIAL BUS

EH

Figure 2-20. DC and AC Circuit Breaker Panels (Typical) (Sheet 4 of 4)

system is provided from the No. 1 and No. 2 dc primary buses, through circuit breakers, marked **NO. 1 GEN WARN** and **NO. 2 GEN WARN**, respectively.

NOTE

When the **GEN BRG** caution light remains on for more than 1 minute, make an entry on the DA Form 2408-13-1.

2.65.1 Generator Control Units (GCU). The GCUs monitor voltage from the No. 1, No. 2 and APU generators and take the generator(s) off-line where malfunctions occur. Underfrequency protection is disabled in flight by the WOW switch.

2.65.2 AC Secondary Bus.  The ac secondary bus is powered by the No. 1 and No. 2 generators when they are operating and their outputs are acceptable (Figure 2-19). Current limiters protect the system from excessive current draw. If the No. 1 and No. 2 generators are off, the APU generator will supply the ac secondary bus if the output is acceptable, the backup hydraulic pump is off, the blade deice is off, and the weight of the helicopter is on the wheels. The ac secondary bus can also receive power from external power when the weight of the helicopter is on the wheels, and the No. 1, No. 2 and APU generators are off, and the backup hydraulic pump is not operating.

2.66 AUXILIARY AC POWER SYSTEM.

An auxiliary ac power system (Figure 2-19), is a backup ac power source, providing electrical power for ground checkouts. The system consists of a 115 vac three-phase, 400 Hz 20/30 kVA, air-cooled generator mounted on and driven by the APU, a current transformer and a generator control unit. If the primary ac generators are not operating, the auxiliary ac power output will be applied through contactors to the No. 2 ac primary bus and through contactors and current limiters to the No. 1 ac primary bus. An advisory light on the caution/advisory panel will go on, indicating **APU GEN ON** when the APU generator is operating, and the APU generator switch is **ON**. **APU GEN ON** light will be on only when supplying power to the system, it will

be off at any time either No. 1 generator or No. 2 generator is supplying power. The generator control switch on the upper console (Figure 2-7), has marked positions of **TEST**, **OFF/RESET**, and **ON**.

NOTE

If the APU generator is the sole source of ac generated power, all equipment may be operated, except that when the backup pump is on, the windshield anti-ice and  air conditioner are prevented from being used.

2.66.1 Generator Control Switches. Generators are controlled by a three-position generator switch on the upper console (Figure 2-7). The switch **ON** position energizes the generator and permits connection of generator ac output to the ac loads. **TEST** permits you to test the generator ac output without connecting to the generator loads. **OFF/RESET** deenergizes the generator and permits generator recycling if the generator is disabled and disconnected from its loads. The control switch is manually placed to **RESET** and then back to **ON**.

2.66.2 External AC Power System.



Do not connect a source of dc power to the external ac connector.

An external ac power connector, on the right side of the helicopter (Figure 2-1), accepts ground source of 115 vac, three-phase, 400 Hz power. The system is controlled by a switch on the upper console (Figure 2-7), marked **EXT PWR-RESET-OFF** and **ON**. External power will be introduced into the system if acceptable external power is connected, the **EXT PWR** switch is **ON**, and no other generating source is operating. An advisory light on the caution/advisory panel will go on, indicating **EXT PWR CONNECTED**, whenever external power is connected to the helicopter.

Section XII AUXILIARY POWER UNIT

2.67 AUXILIARY POWER UNIT (APU) SYSTEM.

The auxiliary power unit system (Figure 2-21) consists of an auxiliary power unit (APU), accessories, controls, a monitoring system, and a starting system. The APU system provides pneumatic power for main engine starting and cabin heating, and electrical power for ground and emergency in-flight electrical operations.

NOTE

The APU is not qualified for normal inflight use.

APU system accessories include a prime/boost pump, hydraulic accumulator, hydraulic handpump, hydraulic start motor, and ac generator. The hydraulic accumulators and handpump, in the aft midsection cabin ceiling (Figure 2-5), provide the hydraulic pressure for driving the APU starter. If the APU does not start, the hydraulic accumulator can be recharged by pumping the hydraulic handpump. The hydraulic utility module and backup pump, on the left forward deck within the main rotor pylon, will automatically recharge the depleted hydraulic accumulator for the next APU start. The APU controls are in the cockpit on the upper console. Indicator lights on the caution/advisory panel provide cockpit monitoring of the APU. An indicator panel in the cabin will indicate reason for APU shutdown on BITE indicators. The BITE indicators are incorporated in the APU electronic sequence unit (ESU), and will indicate reasons for APU shutdown. Those indicators can be monitored during APU operation without interrupting normal operating systems. During a start, the ESU compares input signals from speed, time, and temperature sensors on the APU to specified values stored in the ESU memory, and performs functional steps as a result of the comparison. The system also provides for APU protective shutdown in case of turbine overspeed, underspeed, high exhaust temperature, low oil pressure, or loss of electrical power or sequence failure. Each major sequence step will have a visual indication of go/no-go. The ESU samples predetermined parameters of exhaust temperature, turbine speed and oil pressure. If any one of the predetermined values are exceeded, the APU will shut down, and appropriate BITE indication is made. On helicopters modified with improved ESU, if a momentary malfunction occurs (i.e., a power interruption other than switching of the **APU CONTR** switch) the APU will shut down and the **APU CONTR** switch must be placed at **OFF** and then back **ON**, to restart the APU. There is also an output signal to the caution/advisory panel to turn on the **APU ON** advisory light, indicating the APU is operating.

Power to operate the APU and ESU is provided from the battery bus through a circuit breaker marked **APU CONTR INST**.

2.68 APU.

The auxiliary power unit (Figure 2-21) consists of a gas turbine shaft power section, a reduction gear drive, and appropriate controls and accessories. The accessory gear box provides an axial pad with a 12,000 rpm output drive for the APU ac generator, rpm pad for mounting the APU start motor, rpm drive pad for the APU fuel assembly. A magnetic pickup mounted on the accessory gear box senses engine speed. The APU is lubricated by a self-contained oil system. Refer to Figure 2-25 for servicing.

2.68.1 APU Controls. The APU control, on the upper console (Figure 2-7), consists of a **CONTR** switch and an APU fire extinguisher T-handle. The **APU CONTR** switch, with marked positions **OFF** and **ON**, controls the operation of the APU. Placing the switch **ON** starts the APU and allows it to operate. The APU is off when the switch is **OFF**. The **APU FAIL** caution light will be on any time the APU automatically shuts down. The **APU OIL TEMP HI** caution light is on when APU oil temperature is above normal range. During ground operation at high ambient temperatures the **APU OIL TEMP HI** caution light may go on. If this occurs, the APU should be shut down immediately to prevent damage. After a 30-minute cooling period, the oil level should be checked. If OK, the APU may be restarted. The control system receives electrical power from the battery bus through a circuit breaker marked **APU CONTR INST** on the lower console. When illuminated, the **APU T-handle** warns the pilot/ copilot of a fire in the APU compartment. When the T-handle is pulled, it turns off fuel to the APU, sends a stop signal to the ESU, arms the fire extinguisher system, and sets the extinguisher direction control valve to the APU. During APU starts using battery power, if the fire extinguisher is required, **FIRE EXTGH RESERVE** must be used. The T-handle microswitch receives electrical power from the battery utility bus through a circuit breaker marked **FIRE EXTGH** on the lower console circuit breaker panel.

2.68.2 APU Fuel Control System (Helicopters equipped with (T-62T-40-1 APU). This system consists of a fuel pump and a control assembly. The fuel pump is protected by a filter. Fuel pump output flow passes through another filter before entering the control assembly. A governor and flow metering valve controls fuel flow to the engine during ignition, permitting automatic starting under

AA0519
SA

Figure 2-21. Auxiliary Power Unit (APU) (Typical)

all ambient conditions, and controls the turbine at a constant speed once it has accelerated to operating speed. An electronic speed sensing device provides automatic fuel flow, ignition, and operation of the APU.

2.68.3 APU Fuel Control System (Helicopters equipped with GTC-P36-150 APU). The fuel control system includes a fuel pump and metering section. The fuel pump is protected by an integral inlet filter. Fuel pump output flow passes through a filter screen before entering the metering assembly. Fuel pump discharge pressure is limited by an ultimate relief valve which, when activated, bypasses fuel flow back to the pump inlet. Fuel metering is accomplished by the torque motor metering valve as a function of an electrical signal from the electronic sequence unit (ESU). For accurate fuel metering, a constant, pressure drop across the metering valve is maintained by the differential pressure regulating valve. The fuel solenoid valve is energized by the ESU following the initiation of APU start. This allows fuel to flow to the engine. The fuel control assembly subsequently provides fuel according to a pre-programmed schedule to effect efficient acceleration. The fuel solenoid valve will close completely without visible leakage from the minimum operating fuel pressure to 110% of the maximum operating fuel pressure.

2.68.4 APU Fuel Supply System. APU fuel is supplied to the APU from the left main fuel tank. The **FUEL PUMP** switch must be at **APU BOOST** for all APU operation, except engine priming. The APU prime/boost shut-off valve is a two-position, open-closed unit mounted on the APU compartment firewall where it also functions as a firewall shutoff valve. The valve is pilot-operated from the upper console **FUEL PUMP** switch as well as by the **FIRE EXTG H APU** T-handle. If the APU does not start and the **APU ACCUM LOW** advisory light is not on, the manual override lever on the accumulator manifold should be pulled to attempt another start, and held until the APU has reached self-sustaining speed.

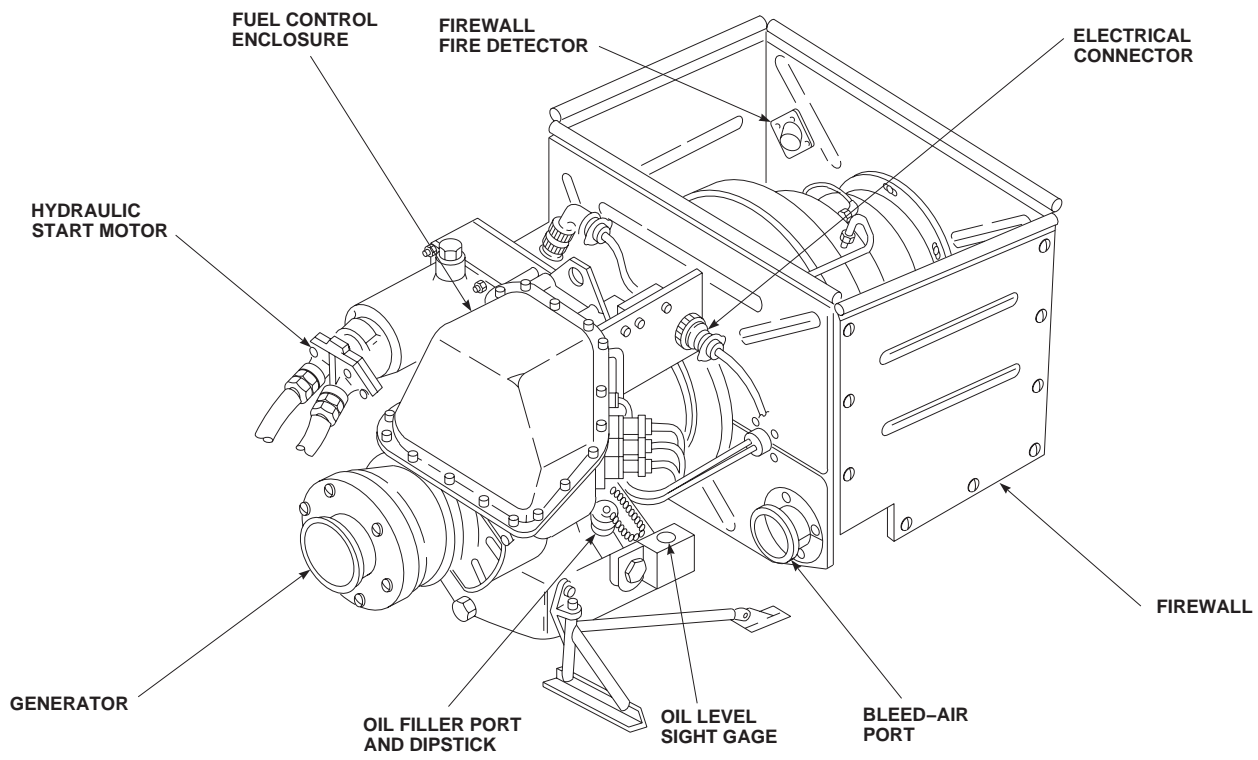
2.69 ACCUMULATOR RECHARGE.

The accumulator recharge cycle starts when the APU has reached operational speed and the APU-driven generator comes on the line. The pressure switch for the accumulator causes the **APU ACCUM LOW** light to go on and the backup system pump to develop pressure. The APU accumulator pressure should be at least 2800 psi before attempting an APU start. The accumulator is recharged from the backup pump which runs for 90 seconds after the accumulator low-pressure switch is actuated. When the

winterization kit is installed, an additional identical accumulator is installed in parallel with the original accumulator. Discharge and recharge of the added accumulator is the same, except a 180-second recharge cycle for the two accumulators will take place when the accumulator pressure switch senses low accumulator pressure. Both accumulators are charged or discharged simultaneously. If the accumulators do not fully charge during the first 180 seconds of the backup pump operating cycle, the pump will continue to operate in 180-second segments, or until the **BACKUP PUMP PWR** circuit breaker is pulled, or 115 vac power is removed. The backup system pump shuts down after recharge, unless required for other purposes. Should the accumulator pressure drop, the backup system pump restarts to replenish the accumulator charge. The rate of accumulator charge is limited to protect the backup system from

possible depletion due to ballistic damage to the APU start system. Should the APU not start, the accumulator may be recharged by these methods, after the **APU CONTR** switch is **OFF**. An electric ground cart powering the backup hydraulic pump or a hydraulic ground cart connected to the backup hydraulic system through the ground test quick-disconnects or by using the handpump in the aft upper cabin. The **APU CONTR** switch should not be turned **ON** again or the **BATT** switch turned **OFF** until after the ESU BITE indicators have been checked. The handpump may also be used to top off the accumulator charge if the charge has dropped due to a low temperature condition. A pressure gage mounted in the aft cabin (Figure 2-5) indicates the charge. Check valves prevent draining of the accumulator charge through the system.

Section XIII LIGHTING

2.70 INTERIOR LIGHTING.

The interior lighting system consists of cockpit dome lights, utility lights and cabin dome lights (Figure 2-4). NVG blue-green lighting can be selected for the cockpit dome, instrument panel glare shield, utility lights and cabin dome lights.

2.70.1 NVG Lighting System. The NVG lighting system consists of interior NVG blue-green lighting. Exterior lighting consists of cargo hook well area electroluminescent lighting, infrared formation and position lights, and attachable/detachable controllable searchlight filter. A dimming feature is incorporated in the searchlight system to provide dimming through the collective **SRCH LT PUSH ON - OFF, BRT, DIM** switch. The position and formation lights have IR emitters installed within close proximity to the regular installed lights to enhance outside viewing with night vision goggles.

2.70.2 Cockpit Floodlights. Two blue-green and two white cockpit floodlights are on the overhead cockpit floodlight panel, marked **BLUE, OFF** and **WHITE** (Figure 2-7). Power is supplied from the dc essential bus through a circuit breaker marked **LIGHTS SEC PNL**. Six lights installed in the instrument panel glare shield provide secondary lighting for the instrument panel. The lights are mechanically dimmed by a control on the upper console labeled **GLARESHIELD LIGHTS** with marked positions **OFF** and **BRT**. Power to operate the glare shield lights is provided from the No. 1 ac primary bus through a circuit breaker, marked **LIGHTS GLARE SHLD**.

2.70.3 Flight Instrument Lights. Instrument lights are grouped into flight instrument and nonflight instruments. The flight instrument lights are divided into pilot's and copilot's. Lights are controlled by individual rotary intensity controls (Figure 2-7), marked **INSTR LT PILOT FLT, OFF** and **BRT**, and **CPLT FLT INST LTS, OFF** and **BRT**. The nonflight instrument lights operate in the same manner as the flight instrument lights. The nonflight lights intensity is controlled by a rotary control, marked **INSTR LT NON FLT, OFF** and **BRT**. Instrument lighting is provided by instrument bezels with NVG lights. The radar altimeters lighting incorporates dimming controls on the instrument panel, marked **RAD ALT DIMMING** for pilots radar altimeters (Figure 2-9). The vertical instrument display system has NVG information panel lighting to make those instruments compatible with the NVG system. Power to operate the instrument lights is provided by the No. 2 ac primary bus through circuit breakers marked **LIGHTS**

PLT FLT and **LIGHTS NON FLT**, and No. 1 ac primary bus, through a circuit breaker marked **LIGHTS CPLT FLT**.

2.70.4 Lighted Switches Dimmer. A dimmer control labeled **LIGHTED SWITCHES** (Figure 2-7) is provided on the upper console to reduce illumination level of the following panel lighted switches: Pilot and copilot **MODE SEL, TAILWHEEL LOCK, CIS MODE SEL, AUTO FLIGHT CONTROL** and **NO. 1** and **NO. 2 FUEL BOOST PUMP** on lights. The caution/advisory panel must be in **DIM** mode.

2.70.5 Upper and Lower Console Lights. NVG lights for the upper console, cockpit flood secondary lights, engine control quadrant, flight control panel, miscellaneous switch panel, boost pump control panel, ESSS related panels, range extension fuel management panel, retransmission control and rescue hoist panels, and compass are illuminated from the No. 1 ac primary bus through dimmer controls marked **CONSOLE LT UPPER** and **LOWER**. Circuits are protected by circuit breakers marked **LIGHTS UPPER CSL** and **LIGHTS LWR CSL**. All other lower console panels are illuminated by the lower console auxiliary utility light next to the copilot's seat.

2.70.6 Utility Lights. All utility lights are dual (blue/green-white) (Figure 2-4). Two portable cockpit utility lights with coiled cords are attached to the upper console by removable brackets, one on each side of the console. The lights may be adjusted on their mountings to direct the light beams or they may be removed and used portably. All utility lights are controlled by a rheostat or a pushbutton on the end of each casting. The lens casting of the lights may be turned to change from white to blue/green and/or spot to flood. An auxiliary utility light, located at the right rear of the copilot's seat, is used to illuminate some panels on the lower console for night flight. On helicopters equipped with a transition equipment bay, a utility light is installed on the bay shelf to provide bay lighting **EB**. The utility lights operate in the same manner as above. Make certain cockpit utility lights are **OFF** when not in use. The utility lights operate from the battery utility bus through a circuit breaker marked **UTIL LTS CKPT**. On helicopters 97-26744 and subsequent, utility lights operate from the battery bus through a circuit breaker marked **UTIL LTS CKPT**.

2.70.7 Cabin Dome Lights. Three dome lights are provided for cabin lighting (Figure 2-5). Control of cabin lights is from the upper console by a control marked **CABIN**

DOME LT (Figure 2-7) with intensity control and a light color selector switch. The intensity control has marked positions **OFF** and **BRT**, and the light level control may be adjusted to any position between the two extremes. The light color selector switch has marked positions **WHITE**, **OFF**, and **BLUE**. To place the switch from **OFF** to **WHITE**, the switch must first be pulled out to clear a detent. This prevents accidentally placing the switch to **WHITE**. Dimming control for the cabin dome lights is from a control on the left side of the pilots seat (Figure 2-4), marked **CABIN DOME LT**, with marked positions **OFF** and **BRT**. Power to operate the cabin dome light system is provided from the No. 1 ac primary bus through a circuit breaker marked **LIGHTS CABIN DOME**.

2.70.8 Maintenance Light. A portable 20 watt floodlight, in the cabin at the crew chief station is used by the crew for maintenance work. The light has a 20-foot cord, allowing its use within the cabin and around the main transmission. A switch on the rear end of the light with marked positions, **DIM**, **OFF**, and **BRIGHT**, controls the light intensity. Another maintenance light receptacle, in the aft tailcone, allows the light to be used around the tail section. Power to operate the light is from the battery utility bus through a circuit breaker marked **UTIL LTS CKPT**. The maintenance light is stowed in a bag at the back of the pilot's seat. Power to operate the maintenance lights is provided from the battery utility bus through a circuit breaker, marked **UTIL LTS CKPT**. Make sure the maintenance and cockpit utility lights are **OFF** when not in use.

2.71 EXTERIOR LIGHTS.

2.71.1 Searchlight.



Landing and searchlight have less than one foot ground clearance when extended. Use caution when ground taxiing over rough terrain when landing light and/or searchlight are extended.

UHThe searchlight (Figure 2-1) is mounted on the right bottom of the nose section, and is controlled from either collective pitch stick. The 150 watt light can be moved forward through a 120° arc from the stow position. It can also be turned 360° in either a right or left direction on its axis. The light is operated by a switch labeled **SRCH LT ON**, **OFF**, **BRT**, and **DIM** (Figure 2-4). Directional control of the light is provided through the four-position searchlight control switch, labeled **EXT** (extend), **RETR** (retract), **L** (left), and **R** (right). When the **SRCH LT** switch is

placed **ON**, the lamp will go on, arming the control switch. Placing the control switch to **EXT** causes the light beam to move forward at a rate of about 12° per second. If the switch is placed to **OFF** the light will extinguish. To retract the searchlight, place the switch to **RETR**. Refer to Chapter 5 for extend/retract limitations. An infrared filter can be installed on the controllable searchlight to enhance viewing objects outside the helicopter when wearing the night vision goggles. With the IR filter installed, maximum wattage lamp to be used is 250 watt. An **OUTPUT** switch on the searchlight dimmer under the pilot's seat, is placed at **NORM** when dimming feature on searchlight is desired. When in **BYPASS** position, the searchlight cannot be dimmed. The IR filter shall not be used with a 450 watt lamp installed. The dimming feature of the controllable searchlight provides a variable light level from 250 to 0 watts to the pilot and copilot through a switch on each collective grip marked **SRCH LT ON - OFF**. Push **ON - OFF BRT DIM** to control power to the light and the **DIM/BRT** mode selector. When the light is on, the **BRT DIM** switch may be moved to select the desired light level. When the desired level is reached, the switch is released to the center position. Power to light and control the searchlight is provided from the dc essential bus through circuit breakers, marked **LIGHTS**, **CONTR PWR** and **SRCH CONTR**. The IR filter may be removed for unaided night flight.

2.71.2 Landing Light. One 600-watt landing light is mounted on the left side beneath the nose section and is controlled from both collective pitch stick grips (Figure 2-14). The light can be extended 107° from the stowed position. A dual function switch is used to operate the light. The **LDG LT PUSH ON-OFF** switch controls lighting and **EXT**, **RETR** controls light position. When the light is **ON** (**LDG LT ON** advisory light should be on) and the switch is at **EXT** detent, the light can be positioned at any point between stowed and fully extended, or it will continue to extend until reaching its limit and power is removed. When the switch is held at **RETR** the light retracts to the stowed position. When the light reaches its stowed position, power is automatically removed from the motor. The **LDG LT PUSH ON-OFF** switch must be pushed **OFF** (**LDG LT ON** advisory light should go off). Refer to Chapter 5 for extend/retract limitations. During extension, the travel speed is about 12° per second, and during retract, about 30° per second. Power to light and control the landing light is supplied from the No. 1 dc primary bus through circuit breakers, marked **LIGHTS**, **RETR LDG**, **CONT** and **PWR**.

2.71.3 Anticollision Lights. This light system contains four strobes in two separate units, one beneath the aft fuselage and one on top of the aft pylon section. The lights are controlled by two switches on the upper console (Figure

2-7) labeled **ANTI COLLISION LIGHTS UPPER, BOTH, LOWER** and **DAY, OFF, NIGHT**. The system consists of a dual power supply and two interchangeable day/night anticollision lights. The dual supply system provides separate outputs for the aft fuselage light and the pylon mounted light. Each anticollision light assembly contains two lamps, the upper lamp within a red lens for night operation and the lower within a clear lens for day operation. Proper operation is selected by placing the switch to **DAY** or **NIGHT**. The desired strobe(s) is selected by placing the switch to **UPPER, LOWER** or **BOTH**. If at **BOTH**, the lower fuselage and the aft pylon lights will alternately flash. If the selector switch is placed to **UPPER** or **LOWER**, only that light will flash. To discontinue operation of the anticollision light(s), the **DAY-NIGHT** switch is placed to **OFF**. Power to operate the anticollision light system is provided from the No. 2 ac primary bus through a circuit breaker, marked **LIGHTS, ANTI COLL.**

2.71.4 Position Lights. Position lights (Figure 2-1) are outboard of the left and right landing gear support and top tail pylon. The lights are red on the left, green on the right, and white on the tail. Control of the position lights is through the upper console panel containing two switches, marked **POSITION LIGHTS, DIM, OFF, BRT,** and **STEADY, FLASH**. When the intensity switch is placed to **DIM** or **BRT**, all three lights go on at once. If the **STEADY-FLASH** switch is placed to **FLASH**, the three lights will flash. The **STEADY** position causes the lights to remain on continuously. Power to operate the position lights is provided by No. 2 dc primary bus through a circuit

breaker, marked **POS LTS**. Infrared position lights are installed within close proximity of the standard position lights. NVG operation is selected through a toggle switch on the upper console (Figure 2-7) marked **NAV LTS**, with switch positions **NORM** and **IR**. Position lights are to be selected through a switch marked **POSITION LIGHTS, DIM, OFF,** or **BRT**, and mode of operation through a switch marked **STEADY** or **FLASH**. Power for control of the IR lights is from the No. 2 dc primary bus through a circuit breaker marked **IR LTS**.

2.71.5 Formation Lights. These lights (Figure 2-1) are on top of the main pylon cowling, tail drive shaft cover, and horizontal stabilator. The system consists of four green electroluminescent lights. The lights are controlled by a single rotary selector switch, marked **FORMATION LT**, with marked positions **OFF** and **1** through **5**. Position **5** is the brightest. When NVG operations are required, IR lights may be used to enhance viewing outside the helicopter. IR lights are selected through a toggle switch on the upper console (Figure 2-7) marked, **NAV LTS, NORM,** and **IR**. This switch shares operation with the **IR** position lights when operating in a NVG environment. Dimming of the IR lights is done with the **FORMATION LT** control, as used with the electroluminescent formation lights. Selection of position **1** through **4** causes the IR formation lights to illuminate at the same intensity. Position **5** causes the lights to illuminate brighter. Power to operate the formation lights is provided from the No. 2 ac primary bus through two circuit breakers, marked **LIGHTS, FORM LV** and **HV**.

Section XIV FLIGHT INSTRUMENTS

2.72 PITOT-STATIC SYSTEM.

Two electrically-heated pitot tubes with static ports are aft and above the pilot's and copilot's cockpit doors. The right pitot tube is connected to the pilot's instruments and the left pitot tube is connected to the copilot's instruments. Tubing connects the pitot tube static pressure ports to the airspeed indicators and the altimeters. In addition to standard instrumentation, airspeed data is sensed for operation of stabilator, flight path stabilization, and command instrument system. Refer to Section IX for pitot tube heater system.

2.73 ATTITUDE INDICATING SYSTEM.

Helicopter pitch and roll attitudes are sensed by the pilot's and copilot's vertical displacement gyroscopes, that apply attitude signals to the vertical situation indicators (VSI) for visual display (Figure 2-9). Signals are applied through the **VERT GYRO** select switches to the remote indicator on the vertical situation indicators. Helicopter pitch and roll attitudes are shown on the pilot's and copilot's vertical situation indicators. The indicator face contains a fixed bar, representing the helicopter, a movable sphere with a white horizon line dividing the two colors, white above and black below, a fixed bank angle scale and a bank index on the moving sphere. Relative position of the fixed bar (helicopter) and the horizon line indicates the helicopter's attitude referenced to the earth horizon. A **ROLL** trim knob on the lower left of the VSI permits adjustment of the roll index about $14^{\circ} \pm 6^{\circ}$ right and left from zero. A **PITCH** trim knob on the lower right of the VSI permits adjustment of the indicator sphere $14^{\circ} \pm 6^{\circ}$ for dive and $7^{\circ} \pm 3^{\circ}$ for climb from zero index. If a power failure or unbalance occurs in the pilot's or copilot's vertical displacement gyroscope, a gyroscope power failure flag will appear, indicating **ATT**, warning the pilot or copilot that pitch and roll attitude signals are not being sent to his indicator. To restore attitude information to the indicator, the pilot or copilot should press his **VERT GYRO** select switch on the **MODE SEL** panel so that **ALTR** appears in the switch window. This causes the **ATT** flag on the indicator to disappear, and pitch and roll signals are supplied from the operating gyro, restoring attitude information display. Refer to Chapter 3 for description of **VERT GYRO** select switch.

2.74 TURN RATE INDICATING SYSTEM.

A 4-minute turn rate (turn and slip) indicator is at the bottom center of each VSI (Figure 2-9). The pilot's and copilot's indicators operate independently of each other

through **TURN RATE** switches on the **MODE SEL** panels. Each system consists of a rate gyro, a turn slip indicator and a select switch. The VSI contains a moving turn rate needle and a fixed turn rate scale for indicating rate and direction of turn. During straight flight the needle is positioned at the center of the scale. When the helicopter turns, the rate-of-turn signal from the rate gyroscope deflects the needle in the proper direction to indicate the turn. Amount of deflection is proportional to the rate-of-turn. A one-needle width deflection represents a turn of 1.5° per second. The VSI also contains a slip indicator that shows uncoordinated turns. If a power failure or unbalance occurs in the pilot's or copilot's rate gyroscope, the associated VSI signal will be lost. To restore rate-of-turn information to the indicator, the pilot or copilot will press the **TURN RATE** switch on his **MODE SEL** panel so that **ALTR** appears in the switch window. This applies alternate rate gyroscope signals from the operating gyroscope to the indicator. Power to operate the pilot's turn rate system is provided from the dc essential bus through a circuit breaker, marked **PILOT TURN DETR**. The copilot's system is powered from the No. 1 dc primary bus through a circuit breaker, marked **CPLT TURN RATE GYRO**. Refer to Chapter 3 for a description of the **TURN RATE** select switch.

2.75 AIRSPEED INDICATOR.

Two airspeed indicators (Figure 2-9), are installed on the instrument panel, one each for the pilot and copilot. The indicators are differential pressure instruments, measuring the difference between impact pressure and static pressure. Instrument range markings and limitations are contained in Chapter 5, Section II, System Limits.

2.76 ALTIMETER/ENCODER AAU-32A.

Two altimeters are installed on the instrument panel (Figures 2-9 and 2-22). The altimeter encoder functions as a barometric altimeter for the pilot and a barometric altitude sensor for the AN/APX-100 transponder in mode C. The copilot's functions only as a barometric altimeter. The system is equipped with a continuously operating vibrator to improve altitude measuring accuracy. The altimeter's operating range is from -1000 feet to 50,000 feet. The face of the instrument has a marked scale from zero to nine in 50-foot units. The operating indicators and controls are a 100-foot pointer, 100-foot drum, 1,000-foot drum, 10,000-foot drum, barometric pressure set knob, barometric pressure scale window and warning flag. The warning flag is only used in conjunction with the encoder. A counter window next to the sweep hand contains the three digital drums

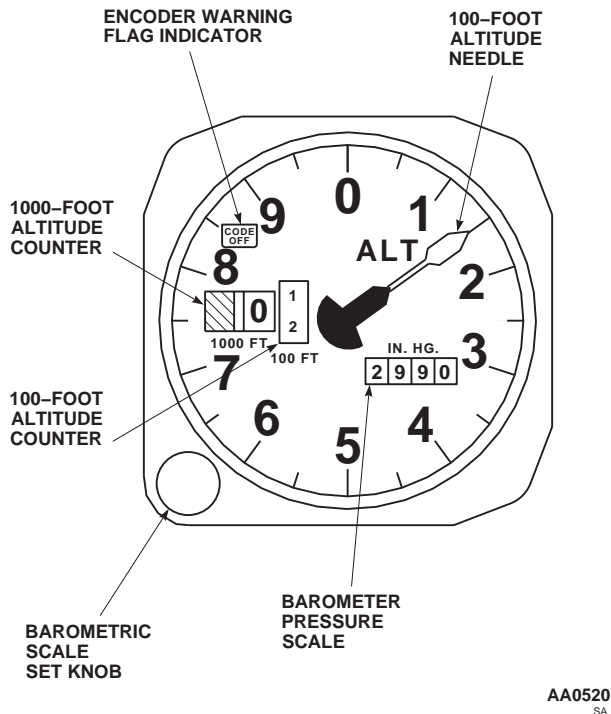

Figure 2-22. Altimeter Encoder AAU-32A

that rotate to indicate the altitude of the helicopter. Another window in the upper left section of the instrument face indicates the normal code operation. When the system fails to transmit signals to the transponder, a flag marked **CODE OFF** will appear in the window. A window on the lower right section of the instrument face indicates barometric pressure setting. The barometric pressure set knob is on the lower left corner of the indicator bezel. Power to operate the encoder system is provided by the No. 2 dc primary bus through a circuit breaker, marked **PILOT ALTM**.

2.77 VERTICAL SPEED INDICATOR.

Two indicators are installed, one each in front of the pilot and copilot (Figure 2-9), to indicate rate of climb or descent.

2.78 STANDBY MAGNETIC COMPASS.

A magnetic compass is installed above the instrument panel on the right center windshield frame (Figure 2-4). The compass is used as a standby instrument for heading references. A compass correction card with deviation errors is installed on the right side of the upper console.

2.79 FREE-AIR TEMPERATURE (FAT) INDICATOR.

The free-air temperature indicator is a direct reading instrument marked **FREE AIR**, and reads in degrees Celsius. One FAT indicator is installed through the center windshield on helicopters without center windshield anti-ice system. On helicopters with center windshield anti-ice system, two indicators are installed through the overhead windows (Figure 2-4).

2.80 CLOCK.

a. Two clocks (Figure 2-9) are installed on the instrument panel. The elapsed time knob is on the upper right corner of the clock. The clock is wound and set with a knob on the lower left corner.

b. Two digital clocks may be installed on the instrument panel. The clock incorporates a six digit liquid crystal display, 24 hour numerals and sweep second indication. A battery allows continuous operation for a minimum of one year when aircraft 28 vdc power is not applied. The clock has two modes of operation, clock mode (C) and the elapsed time mode (ET). Power to operate the clock is provided by the No. 1 dc and No. 2 dc primary buses through circuit breakers marked **CPLT ALTM** and **PILOT ALTM** respectively.

2.81 MASTER WARNING SYSTEM.

Two master caution lights (Figures 2-9 and 2-23) one each side for the pilot and copilot, marked **MASTER CAUTION PRESS TO RESET**, are on the master warning panel. They light whenever a caution light goes on. These lights alert the pilots and direct attention to the caution/advisory panel. The master caution lights should be reset at once to provide a similar indication if a second condition or malfunction occurs while the first is still present. The master caution light can be reset from either pilot position. Four amber warning lights, also on the master warning panel, require immediate action if they go on. The markings are **#1 ENG OUT**, **#2 ENG OUT**, **FIRE**, and **LOW ROTOR RPM**. The **LOW ROTOR RPM** warning light will flash at a rate of three to five flashes per second if rotor rpm drops below 96% **RPM R**. In addition, if % **RPM R** drops below 96% or Ng drops below 55%, a low steady tone is provided. The low rotor rpm tone is inhibited on the ground through the left landing gear weight-on-wheels switch. The engine Ng steady tone is not inhibited. The **ENG OUT** warning lights and tone will go on at 55% **Ng SPEED** and below. Refer to paragraph 2.14.1



AA0406
SA

Figure 2-23. Master Warning Panel

for description of the FIRE warning lights. Power for the master caution lights is provided from the No. 1 dc primary bus through a circuit breaker, marked **LIGHTS CAUT/ADVSY**.

2.81.1 Caution/Advisory Light System. The caution/advisory panel, (Figures 2-9 and 2-24) is on the left of center of the instrument panel. The caution section (upper two-thirds) of the panel, indicates certain malfunctions or unsafe conditions with amber lights. The advisory section (lower one-third) of the panel shows certain noncritical conditions with green lights. Each light has its own operating circuit and will remain on as long as the condition that caused it to light up exists. The caution and advisory lights are powered by the No. 1 dc primary bus through a circuit breaker, marked **LIGHTS CAUT/ADVSY**. Refer to major systems for a complete description of caution-advisory panel capsules. Refer to Table 2-3 for a brief description of each fault.

2.81.2 Caution/Advisory BRT/DIM - TEST Switch.

Testing of the caution/advisory lights is done through a momentary spring-loaded to center switch marked **BRT/**

DIM and **TEST**, on the lower left of the caution/advisory panel (Figure 2-24). Placing the switch to **TEST** simultaneously checks all lights on the caution/advisory and the master warning panels and **#1** and **#2 FUEL LOW** caution lights and **LOW ROTOR RPM** warning lights will flash. When the pilot's **PILOT FLT** rotary intensity control is moved from the **OFF** position, placing the **BRT/DIM-TEST** switch to **BRT/DIM** causes the caution/advisory lights and master warning lights to change intensity. When the lights are dim and power is removed, the light intensity will return to bright when power is reapplied. The **TEST** switch position receives power from the No. 1 dc primary bus through a circuit breaker, marked **LIGHTS CAUT/ADVSY**. The **BRT/DIM** switch position receives power from the dc essential bus through a circuit breaker, marked **CAUT/ADVSY PNL**, on the No. 1 circuit breaker panel. Dimming of the cockpit indicator lights operates with the **CAUTION** panel dimming system.

Table 2-3. Caution/Advisory and Warning Light Lighting Parameters

LEGEND	ILLUMINATING PARAMETER OR FAULT
	CAUTION CAPSULES
#1 FUEL LOW	Flashes when left fuel tank level is about 172 pounds.
#1 FUEL PRESS	Left engine fuel pressure between engine-driven low-pressure fuel pump and high-pressure fuel pump is low.

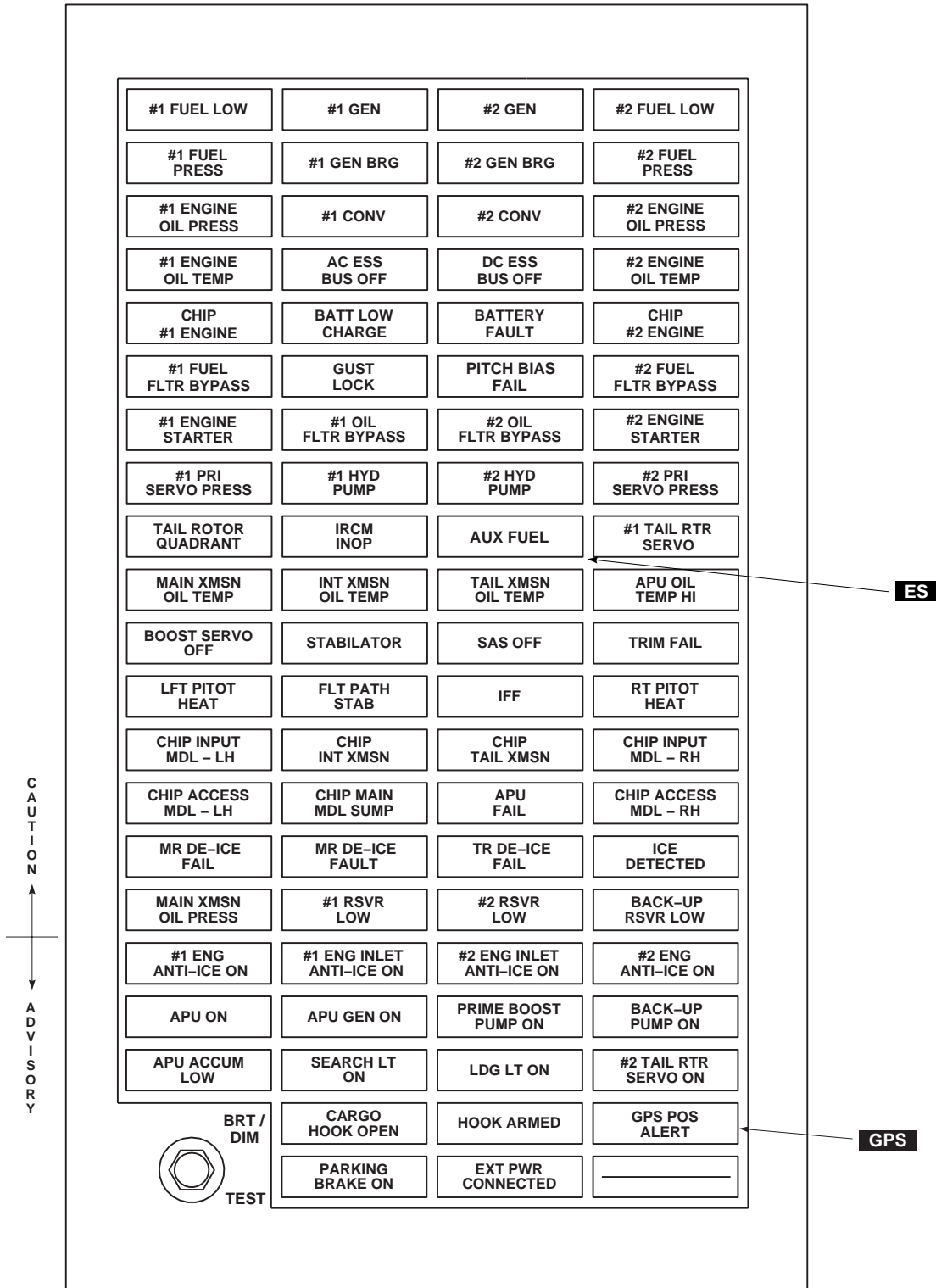

ES

GPS

Figure 2-24. Caution/Advisory Panel (Sheet 1 of 2) UH

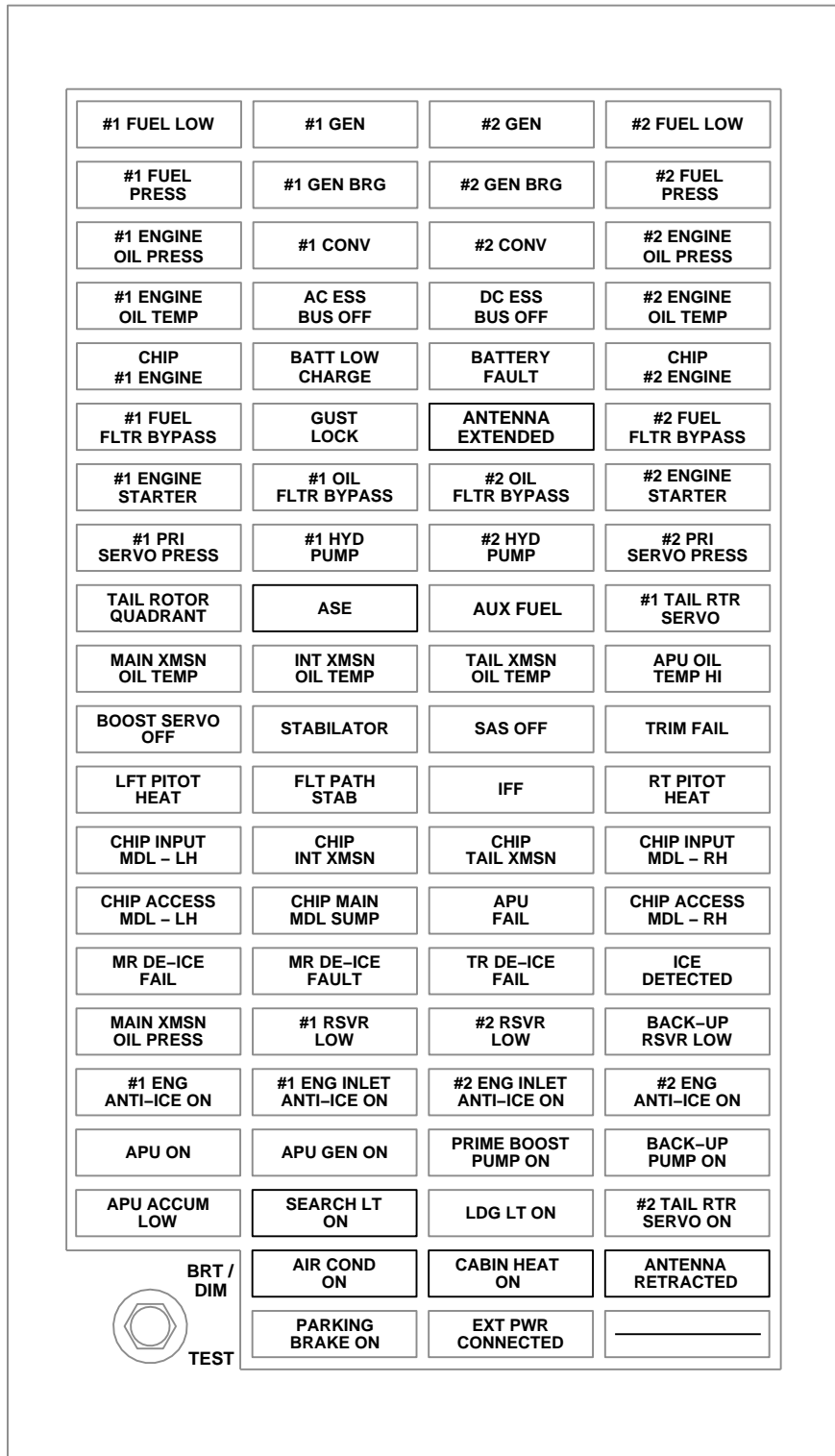

CAUTION
↑
↓
ADVISORY

Figure 2-24. Caution/Advisory Panel (Sheet 2 of 2) EH

Table 2-3. Caution/Advisory and Warning Light Lighting Parameters (Cont)

LEGEND	ILLUMINATING PARAMETER OR FAULT
#1 ENGINE OIL PRESS	Left engine oil pressure is too low for continued operation.
#1 ENGINE OIL TEMP	Left engine oil temperature is above 150°C.
CHIP #1 ENGINE	Left engine chip detector in scavenge oil system has metal chip or particle buildup.
#1 FUEL FLTR BYPASS	Left engine fuel filter has excessive pressure differential across filter.
#1 ENGINE STARTER	Left engine start circuit is actuated.
#1 PRI SERVO PRESS	First stage pressure is shut off, or has dropped below minimum, or servo pilot valve is jammed.
TAIL ROTOR QUADRANT	Goes on when a tail rotor cable is broken or disconnected.
MAIN XMSN OIL TEMP	Main transmission oil temperature is above 120°C.
BOOST SERVO OFF	Indicates loss of second stage hydraulic pressure to the boost servo, or a boost servo jam.
LFT PITOT HEAT	Indicates left pitot heater element is not receiving power with PITOT HEAT switch ON .
CHIP INPUT MDL-LH	Indicates a metal particle has been detected by the chip detector.
CHIP ACCESS MDL-LH	Indicates a metal particle has been detected by the chip detector.
MR DE-ICE FAIL	Indicates a short or open in the main rotor deice system, which will disable the system.
MAIN XMSN OIL PRESS	Main transmission oil pressure is below about 14 psi.
#1 GEN	Left generator is not supplying power to the buses.
#1 GEN BRG	Generator main bearing is worn or has failed.
#1 CONV	Left converter (ac to dc current) has no output.
AC ESS BUS OFF	Indicates that no power (115 vac, phase B) is being supplied to the ac essential bus.
BATT LOW CHARGE	SLAB - Indicates that the voltage on the battery utility bus is at or below 23 vdc. NICAD - Indicates that the battery charge state is at or below about 40% of full charge state.
GUST LOCK	Indicates the gust lock is not fully disengaged.
#1 OIL FLTR BYPASS	Left engine oil filter pressure differential is excessive.
#1 HYD PUMP	Left hydraulic pump output pressure below minimum.
IRCM INOP	Indicates a malfunction has been detected by the infrared countermeasure system or infrared countermeasure system is in a cooldown cycle.
ASE EH	Indicates the ALQ-156 system is being jammed or the ALQ-136, ALQ-144, ALQ-156, or ALQ-162 system is degraded.
INT XMSN OIL TEMP	Intermediate gear box oil temperature is excessive.

Table 2-3. Caution/Advisory and Warning Light Lighting Parameters (Cont)

LEGEND	ILLUMINATING PARAMETER OR FAULT
STABILATOR	Stabilator system is turned on but is in the manual mode.
FLT-PATH STAB	Indicates that FPS is inoperative in one or more axis.
CHIP INT XMSN	Indicates a metal particle has been detected by the chip detector.
CHIP MAIN MDL SUMP	Indicates a metal particle has been detected by the chip detector.
MR DE-ICE FAULT	Indicates partial failure of the blade deice system. Uneven shedding of ice can be expected.
#1 RSVR LOW	Hydraulic fluid level has dropped below about 60% of full capacity.
#2 GEN	Right generator is not supplying power to the buses.
#2 GEN BRG	Generator main bearing is worn or has failed.
#2 CONV	Right converter (ac to dc current) has no output.
DC ESS BUS OFF	Indicates that no power is being supplied to the dc essential bus.
BATTERY FAULT	Indicates that the battery has exceeded safe operating temperature (overtemperature), or a battery cell dissimilarity exists. (On helicopters prior to serial number 97-26744)
PITCH BIAS FAIL	(No longer used)
ANTENNA EXTENDED EH	ECM antenna not fully retracted and at least one of these conditions exist: Helicopter is below radar altimeter LO bug setting, or power is lost, or AN/APN-209 is turned off or is removed.
#2 OIL FLTR BYPASS	Right engine oil filter pressure differential is excessive.
#2 HYD PUMP	Right hydraulic pump output pressure below minimum.
ERFS AUX FUEL	Indicates one or more auxiliary fuel tanks are empty and/or a degraded mode of system operation.
TAIL XMSN OIL TEMP	Tail gear box oil temperature is excessive.
SAS OFF	Hydraulic pressure supplied to the SAS actuator is below minimum.
IFF	Mode 4 is not capable of responding to interrogation.
CHIP TAIL XMSN	Indicates a metal particle has been detected by the chip detector.
APU FAIL	APU was automatically shut down by the electrical sequence unit.
TR DE-ICE FAIL	Indicates a short or open in a tail rotor blade deice element.
#2 RSVR LOW	Hydraulic fluid level has dropped below about 60% of full capacity.
#2 FUEL LOW	Flashes when right fuel level is about 172 pounds.
#2 FUEL PRESS	Right engine fuel pressure between engine-driven low-pressure fuel pump and high-pressure fuel pump is low.

Table 2-3. Caution/Advisory and Warning Light Lighting Parameters (Cont)

LEGEND	ILLUMINATING PARAMETER OR FAULT
#2 ENGINE OIL PRESS	Right engine oil pressure is too low for continued operation.
#2 ENGINE OIL TEMP	Right engine oil temperature is above 150°C.
CHIP #2 ENGINE	Right engine chip detector in scavenge oil system has metal chip or particle buildup.
#2 FUEL FLTR BYPASS	Right engine fuel filter has excessive pressure differential across filter.
#2 ENGINE STARTER	Right engine start circuit is actuated.
#2 PRI SERVO PRESS	Second stage pressure is shut off, or has dropped below minimum, or servo pilot valve is jammed.
#1 TAIL RTR SERVO	Pressure to the first stage tail rotor servo is below minimum, or servo pilot valve is jammed.
APU OIL TEMP HI	APU oil temperature is above the maximum.
TRIM FAIL	Indicates that yaw, roll, or pitch trim actuators are not responding accurately to computer signals.
RT PITOT HEAT	Indicates right pitot heat element is not receiving power with PITOT HEAT switch ON .
CHIP INPUT MDL-RH	Indicates a metal particle has been detected by the chip detector.
CHIP ACCESS MDL-RH	Indicates a metal particle has been detected by the chip detector.
ICE DETECTED	Indicates that ice has been detected.
BACK-UP RSVR LOW	Hydraulic fluid level has dropped below about 60% of full capacity.
ADVISORY CAPSULES	
#1 ENG ANTI-ICE ON	Indicates that No. 1 engine anti-ice/start bleed valve is open.
APU ON	APU is operative.
APU ACCUM LOW	APU accumulator pressure is low.
#1 ENG INLET ANTI-ICE ON	Indicates that No. 1 engine inlet anti-icing air temperature is 93°C or above.
APU GEN ON	APU generator output is accepted and being supplied to the helicopter.
SEARCH LT ON	Either pilot or copilot has selected SRCH LT switch is on.
CARGO HOOK OPEN	Indicates that cargo hook load beam is not latched.
AIR COND ON EH	Power is applied to air conditioner compressor.
PARKING BRAKE ON	Indicates that PARKING BRAKE handle is pulled.
#2 ENG INLET ANTI-ICE ON	Indicates that No. 2 engine inlet anti-icing air temperature is 93°C or above.

Table 2-3. Caution/Advisory and Warning Light Lighting Parameters (Cont)

LEGEND	ILLUMINATING PARAMETER OR FAULT
PRIME BOOST PUMP ON	Prime boost pump switch is at PRIME or BOOST .
LDG LT ON	Either pilot or copilot has selected LDG LT ON .
HOOK ARMED	The cargo hook release system is armed.
CABIN HEAT ON EH	Aux heater system is operating.
EXT PWR CONNECTED	Indicates that external power plug is connected to helicopter's EXT POWER connector.
#2 ENG ANTI-ICE ON	Indicates that No. 2 engine inlet anti-ice/start bleed valve is open.
BACKUP PUMP ON	Backup pump pressure is being supplied.
#2 TAIL RTR SERVO ON	Pressure to 2nd stage tail rotor servo is above minimum.
ANTENNA RETRACTED EH	ECM antenna fully retracted.
GPS POS ALERT GPS	Indicates that GPS signals are not reliable.
MASTER WARNING PANEL	
#1 ENG OUT	No. 1 engine Ng SPEED is below 55%.
FIRE	Indicates a fire detector has actuated a fire warning circuit.
MASTER CAUTION PRESS TO RESET	Indicates a caution light on the caution panel has been actuated by failed system.
#2 ENG OUT	No. 2 engine Ng SPEED is below 55%.
LOW ROTOR RPM	Rotor speed is below about 96% RPM R .

Section XV SERVICING, PARKING, AND MOORING

2.82 SERVICING.

Servicing information is given by systems or components. Points used in frequent servicing and replenishment of fuel, oil and hydraulic fluid are shown in Figure 2-25. Fuel and lubricant specifications and capacities are in Table 2-4. Table 2-5 contains a listing of acceptable commercial fuel.

2.83 SERVICE PLATFORMS AND FAIRINGS.

Service platforms are a part of the engine cowlings, providing access to the engines. Each service platform is about 46 inches long and 18 inches wide. It is capable of supporting a static weight of 400 pounds on any area without yielding. The platform is made of composite metal and fiberglass with a honeycomb core. The engine cowling is opened by releasing a latch on the side and pulling outward on a locking handle. The cowling is opened outward and down, providing a standing area at the lower section. When closed, the cowling lock prevents opening in flight.

2.84 FUEL SYSTEM SERVICING.

a. Both tanks (Figure 2-25) may be serviced simultaneously through pressure refueling or closed circuit refueling. They may be serviced individually by gravity refueling through refueling ports on the left and right sides of the helicopter.

b. **ERFS** The external extended range tanks can only be serviced by gravity refueling through refueling ports on the forward top of each tank.

2.84.1 Fuel Types. Fuels are classified in Table 2-5.

2.84.2 Use of Fuels. Mixing of fuels in fuel tanks. When changing from one type of authorized fuel to another, for example JP-4 to JP-5, it is not necessary to drain the helicopter fuel system before adding the new fuel. Fuels having the same NATO code number are interchangeable. Jet fuels conforming to ASTM D-1655 specification may be used when MIL-T-5624 fuels are not available. This usually occurs during cross-country flights where helicopters using NATO F-44 (JP-5) are refueled with NATO F-40 (JP-4) or Commercial ASTM Type B fuels. Whenever this condition occurs, the operating characteristics may change in that lower operating temperature: slower acceleration, easier starting, and shorter range may be experienced. The reverse is true when changing from F-40 (JP-4) fuel to F-44 (JP-5) or Commercial ASTM Type A-1 fuels.

2.84.3 Gravity Refueling.

1. Ground helicopter to fuel truck or other suitable ground.
2. Plug hose nozzle ground into the helicopter grounding jack, marked **GROUND HERE**, above refueling ports.
3. Remove fuel filler caps and refuel. Refer to Table 2-4 for fuel quantities.

2.84.4 Pressure Refueling.

1. Ground helicopter to fuel truck or other suitable ground.
2. Ground fuel dispenser nozzle to the helicopter grounding point marked **GROUND HERE**, above refueling ports.



Damage to the fuel system could result if refueling hose pressure exceeds 55 psi during pressure refueling or 15 psi during closed circuit refueling.

3. Connect fuel dispenser nozzle to pressure refueling adapter.

NOTE

The system is designed to restrict fuel flow to 300 gpm during pressure refueling at a nozzle pressure of 55 psi and 110 gpm at a nozzle pressure of 15 psi during closed circuit refueling.

4. Start fuel flow from fuel dispenser and refuel helicopter.



If fuel is observed flowing from vent, discontinue refueling and make an entry on DA Form 2408-13-1.

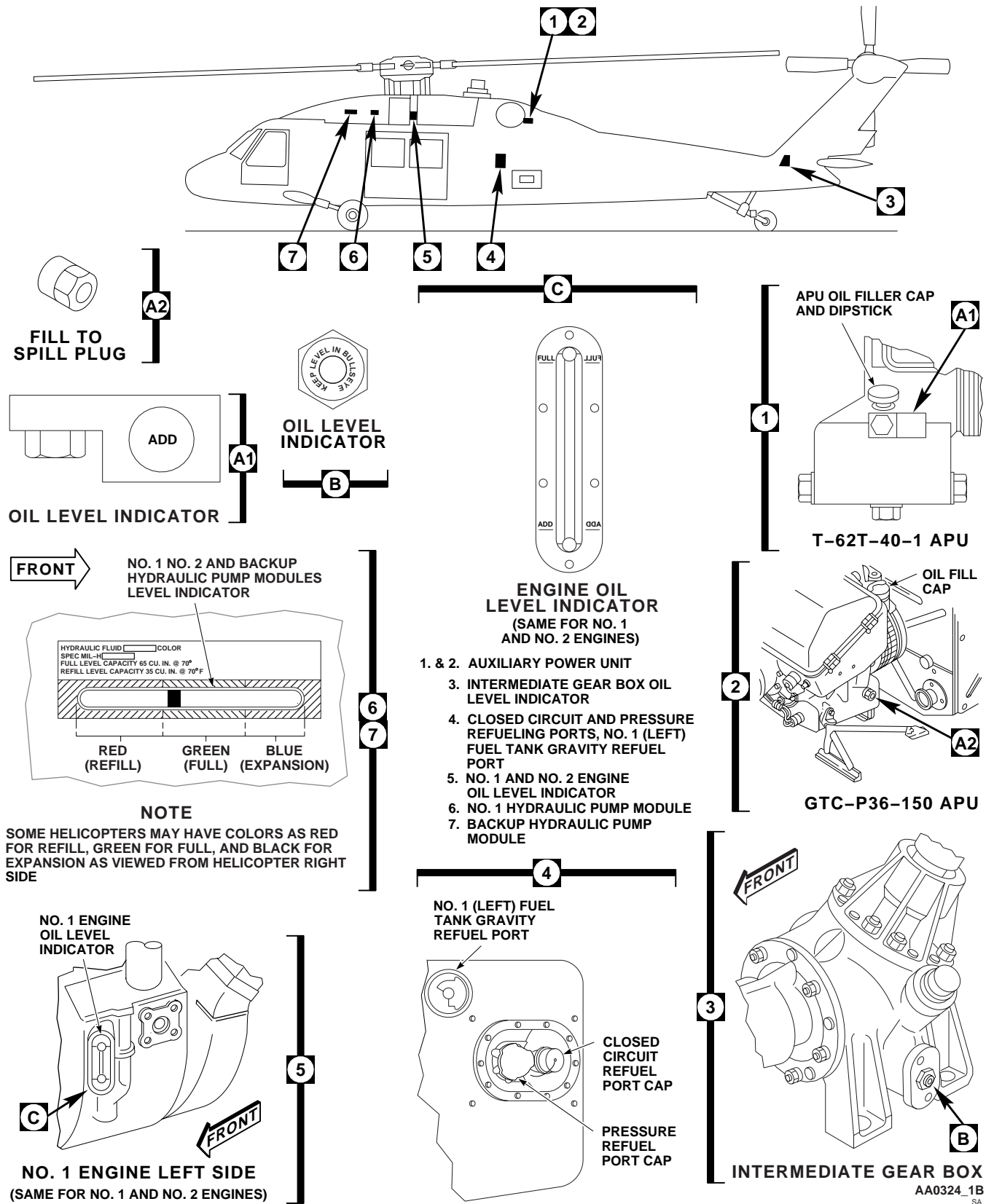
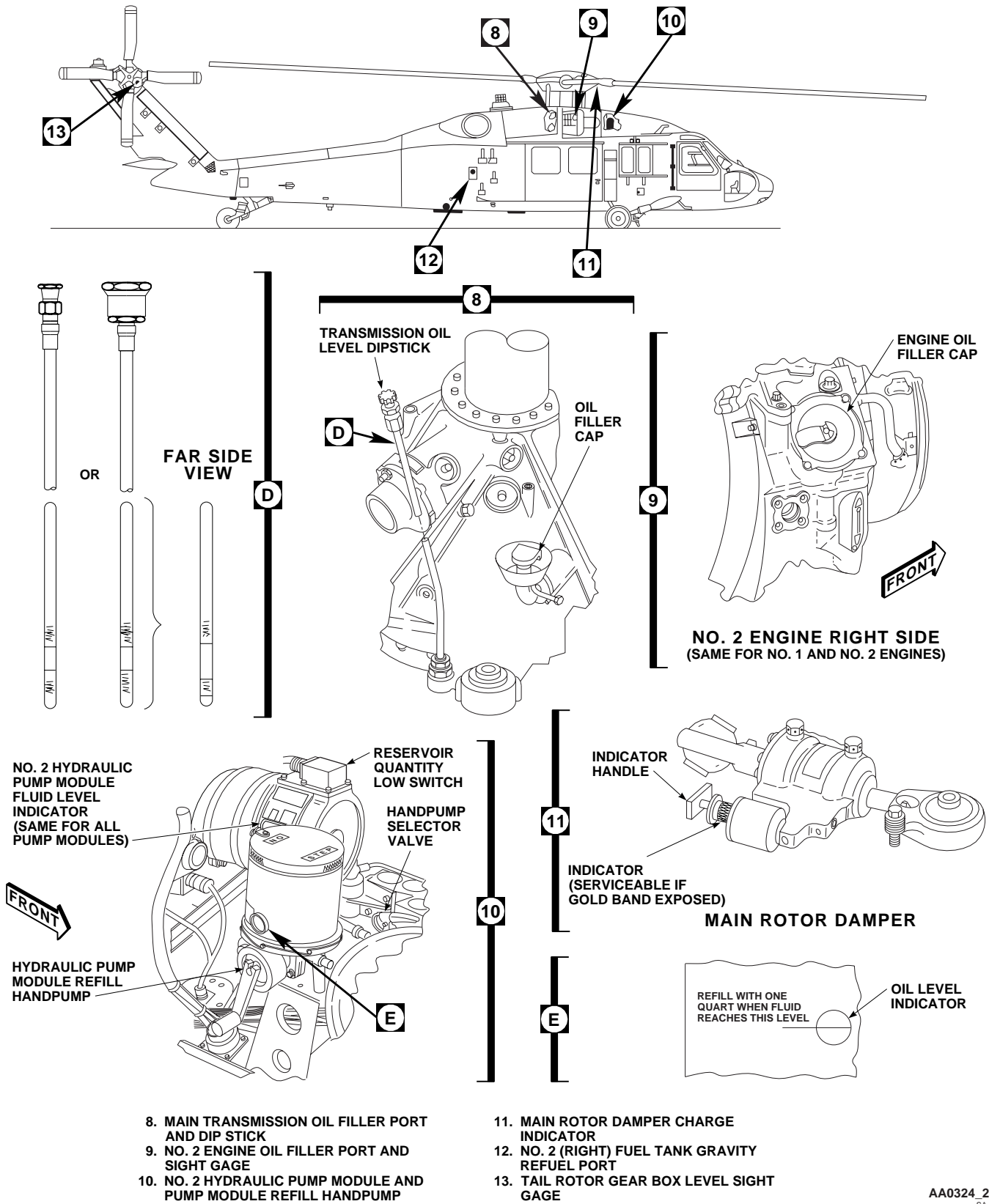

Figure 2-25. Servicing Diagram (Sheet 1 of 3)



AA0324_2
SA

Figure 2-25. Servicing Diagram (Sheet 2 of 3)

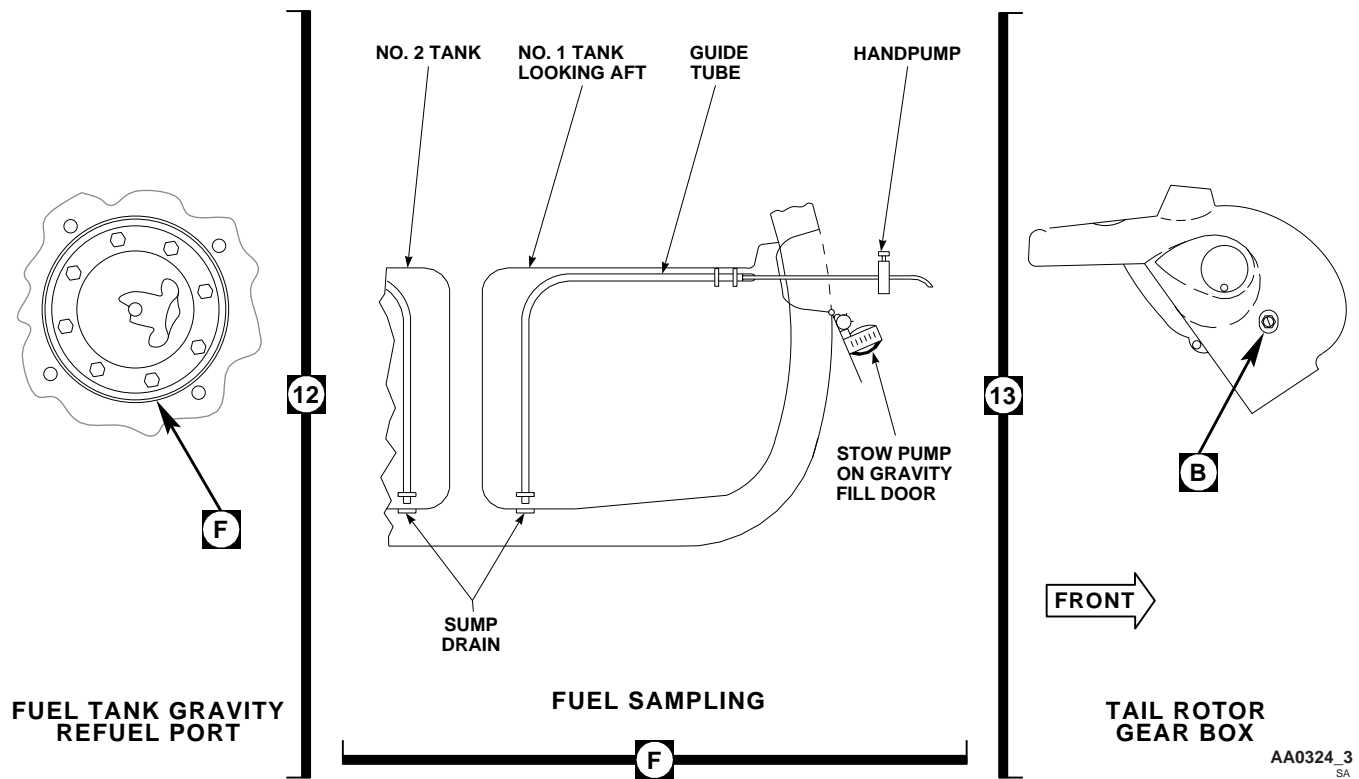

Figure 2-25. Servicing Diagram (Sheet 3 of 3)

- Once fuel has reached the desired level, remove the fuel dispenser nozzle from the refueling adapter and cap pressure fueling adapter.

2.84.5 Fuel Sampling System. Fuel sampling is done with a thumb-operated handpump (Figure 2-25) containing 5 feet of plastic tubing. The tubing is placed in a guide tube inside the fuel tank and is directed to the bottom of the tank. The handpump is stroked and fuel is drawn from the tank, with contaminants at the bottom. When sampling is completed, the tubing is emptied, rolled, and stowed with

the pump on the gravity refueling door. **ERFS** Fuel sampling of the external extended range fuel system is done by taking the sample with a fuel sampler tube from the sump drain located at the bottom aft of each tank.

2.85 EXTERNAL AIR SOURCE/ELECTRICAL REQUIREMENTS.

Refer to Chapter 5 for limitations.

2.86 ENGINE OIL SYSTEM SERVICING.



The helicopter must be level to get accurate oil tank readings. When the helicopter is parked on a slope, the downslope engine will read higher oil level than actual, and the upslope engine will read lower.

NOTE

Do not service the engines with DOD-L-85734 oil. If DOD-L-85734 oil is inadvertently

added to the engines, drain the oil and add MIL-L-7808 or MIL-L-23699 oil. Flushing the system before refilling is not required.

The engine oil tank (Figure 2-25) is within the main frame. When the oil level reaches the **ADD** mark, oil should be added to bring the level to the full mark on the sight gage. Wait at least 20 minutes after engine shutdown before checking engine oil level. Before adding oil, determine whether system contains MIL-L-7808 oil or MIL-L-23699 oil. If flights of over 6 hours are made, engine oil level must be at the full line of sight glass before flight.

Table 2-4. Fuel and Lubricants, Specifications, and Capacities

SYSTEM	SPECIFICATION	CAPACITY
Fuel	Primary: Grade JP-8 (NATO Code F-34) (Notes 1 and 5) Alternate: Grade JP-5 (NATO Code F-44) (Notes 1 and 5) JP-4 (NATO Code F-40) (Note 5)	Main Tanks usable U. S. Gallons of fuel are: 360 gravity, 359 pressure, and 356 closed circuit. External Tank Gravity Refueling: 230 U. S. Gallons each tank.
Engine oil	MIL-L-23699 (NATO Code 0-156) MIL-L-7808 (NATO Code 0-148) (Notes 2, 3 and 7)	7 U. S. Quarts
Auxiliary power unit	MIL-L-23699 (NATO Code 0-156) MIL-L-7808 (NATO Code 0-148) (Notes 2, 3 and 7)	3 U. S. Quarts (T-62T-40-1) 2 U. S. Quarts (GTC-P36-150)
Transmission oil	MIL-L-23699 (NATO Code 0-156) MIL-L-7808 (NATO Code 0-148) DOD-L-85734 (Notes 2, 3, 6, and 8)	7 U. S. Gallons



Lubricating oils MIL-L-23699, DOD-L-85734 and MIL-L-7808 contain materials hazardous to health. They produce paralysis if swallowed. Prolonged contact may irritate the skin. Wash hands thoroughly after handling. Oils may burn if exposed to heat or flames. Use only with proper ventilation.

Table 2-4. Fuel and Lubricants, Specifications, and Capacities (Cont)

SYSTEM	SPECIFICATION	CAPACITY
Intermediate gear box oil	MIL-L-23699 (NATO Code 0-156) MIL-L-7808 (NATO Code 0-148) DOD-L-85734 (Notes 2, 3, 6, and 8)	2.75 U. S. Pints
Tail gear box oil	MIL-L-23699 (NATO Code 0-156) MIL-L-7808 (NATO Code 0-148) DOD-L-85734 (Notes 2, 3, 6, and 8)	2.75 U. S. Pints
First stage hydraulic reservoir	MIL-H-83282 MIL-H-5606 (NATO Code H-515) (Note 4)	1 U. S. Quart
Second stage hydraulic reservoir	MIL-H-83282 MIL-H-5606 (NATO Code H-515) (Note 4)	1 U. S. Quart
Backup hydraulic reservoir	MIL-H-83282 MIL-H-5606 (NATO Code H-515) (Note 4)	1 U. S. Quart
Rescue Hoist	Refer to TM 55-1680-320-23 for servicing.	11.5 U. S. Fluid Ounces

SOURCE PRIMARY OIL ALTERNATE OIL

APPROVED COMMERCIAL OILS

NOTE

Commercial oils listed below are approved alternates for engines and gear boxes except as indicated.

U. S. Military Oil NATO Code No.	DOD-L-85734 (Note 7)	MIL-L-23699 or 0-156	MIL-L-7808 0-148
COMMERCIAL OIL		TYPE II	TYPE I
Castrol Inc.		Castrol 5050 Castrol 5000 Aerojet 5	Castrol 399
Exxon Co.	Turbo Oil 25	Turbo Oil 2380	Turbo Oil 2389 Turbo Oil 2391
Hatco Corp.		HATCO 3211 HATCO 3611 HATCO 1639 HATCO 1680	HATCO 1278 HATCO 1280
Mobil Corp.		Mobil Jet Oil II Mobil Jet Oil 254	

Table 2-4. Fuel and Lubricants, Specifications, and Capacities (Cont)

<u>SOURCE</u>	<u>PRIMARY OIL</u>	<u>ALTERNATE OIL</u>	
Royal Lubricants	Royco 555	Royco 500 Royco 560 Royco 899 Royco 899HC	Royco 808
Shell Oil Company	Aeroshell 555	Aeroshell 500 Aeroshell 560	Aeroshell 308

NOTE

1. When starting in ambient temperatures below -34°C (-29°F), do not use JP-5 or JP-8.
2. When starting in ambient temperatures of -34°C (-29°F) or below, lubricating oil MIL-L-7808 must be used. It is not advisable to mix MIL-L-23699 or DOD-L- 85734 oil with MIL-L-7808 oil.
3. If the type oil being used is not available, another authorized type oil may be added. When one type oil is mixed with another, it is not necessary to drain the system and refill with one type oil. No mixing is allowed for cold temperature operation. For transmissions and gear boxes, when one type of oil is mixed with another, it is not necessary to drain the system and refill with one type oil.
4. For operation below -34°C (-29°F), MIL-H-5606 (NATO Code H-515) shall be used. Mixing MIL-H-5606 with MIL-H-83282 degrades fire-resistant qualities of MIL-H-83282.
5. Fuel settling time for jet (JP) fuel is 1 hour per foot depth of fuel. Allow the fuel to settle for the prescribed period before any samples are taken (about 4 hours for proper settling).
6. DOD-L-85734 oil is the preferred oil for use in the main transmission, intermediate gearbox, and tail gearbox, except for cold temperature operation.
7. DOD-L-85734 oil should not be used in the engines or the auxiliary power unit (APU). If DOD-L-85734 oil is inadvertently added to the engines or APU, the system should be drained and the correct oil added. There is no need to flush the system.
8. When changing from MIL-L-7808 or MIL-L-23699 oil to DOD-L-85734 (and vice versa), drain the oil from the system and refill with desired oil. There is no need to flush the system before refilling.

Table 2-5. Approved Fuels

SOURCE	PRIMARY/STANDARD FUEL	ALTERNATE FUELS	
U. S. Military Fuel	JP-8	JP-5	JP-4
NATO Code No.	F-34	F-44	F-40
COMMERCIAL FUEL (ASTM-D-1655)			
	JET B	JET A	JET A-1
American Oil Co.	American JP-4	American Type A	
Atlantic Richfield Richfield Div.	Arcojet B	Arcojet A Richfield A	Arcojet A-1 Richfield A-1
B. P. Trading	B. P. A. T. G		B. P. A. T. K.
Caltex Petroleum Corp.	Caltex Jet B		Caltex Jet A-1
City Service Co.		CITCO A	
Continental Oil Co.	Conoco JP-4	Conoco Jet-50	Conoco Jet-60
Exxon Co. U. S. A.	Exxon Turbo Fuel B	Exxon A	Exxon A-1
Gulf Oil	Gulf Jet B	Gulf Jet A	Gulf Jet A-1
Mobil Oil	Mobil Jet B	Mobil Jet A	Mobil Jet A-1
Phillips Petroleum	Philjet JP-4	Philjet A-50	
Shell Oil	Aeroshell JP-4	Aeroshell 640	Aeroshell 650
Sinclair		Superjet A	Superjet A-1
Standard Oil Co.		Jet A Kerosene	Jet A-1 Kerosene
Chevron	Chevron B	Chevron A-50	Chevron A-1
Texaco	Texaco Avjet B	Avjet A	Avjet A-1
Union Oil	Union JP-4	76 Turbine Fuel	
INTERNATIONAL FUEL			
	NATO F-40	NATO F-44	NATO F-34
Belgium	BA-PF-2B		
Canada	3GP-22F	3-6P-24C	
Denmark	JP-4 MIL-T-5624		
France	Air 3407A		
Germany	VTL-9130-006	UTL-9130-007 UTL-9130-010	
Greece	JP-4 MIL-T-5624		
Italy	AA-M-C-1421	AMC-143	
Netherlands	JP-4 MIL-T-5624	D. Eng RD 2493	
Norway	JP-4 MIL-T-5624		
Portugal	JP-4 MIL-T-5624		

Table 2-5. Approved Fuels (Cont)

SOURCE	PRIMARY/STANDARD FUEL	ALTERNATE FUELS
Turkey	JP-4 MIL-T-5624	
United Kingdom (Britain)	D. Eng RD 2454	D. Eng RD 2498

NOTE

Commercial fuels are commonly made to conform to American Society for Testing and Materials (ASTM) Specification D 1655. The ASTM fuel specification does not contain anti-icing additives unless specified. Icing inhibitor conforming to MIL-I-85470 or MIL-I-27686 (Commercial name PRIST) shall be added to commercial and NATO fuels, not containing an icing inhibitor, during refueling operations, regardless of ambient temperatures. Icing inhibitor conforming to MIL-I-85470 is replacing the MIL-I-27686 version. The use of MIL-I-27686 icing inhibitor is acceptable until all supplies are depleted. Adding PRIST during refueling operation shall be done using accepted commercial mixing procedures. The additive provides anti-icing protection and also functions as a biocide to kill microbial growths in helicopter fuel systems.

2.87 APU OIL SYSTEM SERVICING.

NOTE

Do not service the APU with DOD-L-85734 oil. If DOD-L-85734 oil is inadvertently added to the APU, drain the oil and add MIL-L-7808 or MIL-L-23699 oil. Flushing the system before refilling is not required.

- a. The APU oil supply is in the APU gear box assembly. The sump filler/oil dipstick port (T-62T-40-1) or cap and fill to spill plug (GTC-P36-150) (Figure 2-25) are on the left side of the gear box housing.
- b. When the APU is cool to the touch the **COLD** side of the dipstick may be used, if the APU is hot to the touch the **HOT** side of the dipstick may be used.

2.88 HANDPUMP RESERVOIR SERVICING.



Do not allow reservoir level to fall below refill line.

Servicing of the refill handpump is done when fluid level decreases to the refill line on the fluid level sight gage, on the side of the pump tank. When fluid level decreases to the refill line, 1 quart of hydraulic fluid can be poured into the reservoir after removing the refill cap. Handpump reservoir level should be replenished only in 1 quart units.

2.89 HYDRAULIC SYSTEMS SERVICING.

Reservoirs (Figure 2-25) for the hydraulic systems are on the hydraulic pump modules. Fluid level sight gages are visible on the side of each pump. All hydraulic pump reservoir capacities are 1 U. S. quart to the blue (black on some pumps) mark. When the indicator reaches the red area (refill) point, 2/3 of a pint is required to return the indicator to the green mark. The fluid level indication is the 1/8 inch wide gold band at the outboard edge of the level piston. To refill the reservoirs, the fluid is supplied from the manual handpump. After flight, fluid in hydraulic systems will be hot. Piston movement of up to 3/8 inch into the blue (black on some pumps) (overflow) zone is acceptable. When piston is beyond this limit, bleed off enough fluid to bring piston back to 3/8 inch above fill limit. To replenish the pump reservoir fluid, do the following:

1. Unscrew handpump lid and pour in clean hydraulic fluid, MIL-H-83282, until pump is full.

Make sure you can always see oil in pump reservoir window while servicing, so not to pump air into pump module's reservoir. Keep filling.

2. Make sure pump cover is clean, then screw lid on tight.
3. Turn selector valve to desired reservoir to be filled. **OUT 1** is left pump module, **OUT 2** is right pump module, and **OUT 3** is backup pump module.
4. While holding selector valve handle down, crank pump handle on handpump clockwise and fill desired hydraulic pump module until forward end of piston in reservoir window is at forward end of green decal on reservoir housing.
5. Check that reservoirs stay full (forward end of piston at forward end of green decal), with fluid at ambient temperature 1 hour after flight.
6. Make sure area remains clean during procedure.
7. Stow selector valve handle in **OUT 4** (capped off) position.
8. Turn on electrical power.
9. Check caution panel for **#1 RSVR LOW**, **#2 RSVR LOW**, and **BACK-UP RSVR LOW** lights are off.

2.90 RESCUE HOIST LUBRICATION SYSTEM SERVICING.

Servicing of the rescue hoist lubrication system consists of replacing automatic transmission fluid in the boom head and the gear box (Figure 4-25) until oil level sight gages indicate full.

2.91 MAIN TRANSMISSION OIL SYSTEM SERVICING.

The transmission oil supply is in the sump case with the filler port and dipstick gage (Figure 2-25), on the right rear of the main module. When filling is required, oil is poured through the filler tube on the main module case, and oil level is checked by a dipstick, marked **FULL** and **ADD**, or **FULL COLD** and **ADD** on one side of the dipstick and **FULL HOT** and **ADD** on the other side. Check oil level as follows:

NOTE

Remove the dipstick, clean and reinsert to obtain correct reading.

a. Single scale dipstick is for checking cold oil levels. Wait at least 2 hours after shutdown to check oil. If oil level must be checked when hot (immediately to 1/2 hour after shutdown), oil level will read about 1/2 inch low (halfway between full and add mark or 1/2 inch below add mark).

b. Dual scale dipstick is for checking cold or hot oil levels. Use appropriate scale when checking oil level. Read hot side of dipstick when checking hot oil (immediately to 1/2 hour after shutdown), or cold side of dipstick when checking cold oil (at least 2 hours after shutdown).

2.92 TAIL AND INTERMEDIATE GEAR BOX SERVICING.

The intermediate gear box oil level sight gage (Figure 2-25) is on the left side of the gear box. The tail gear box oil level sight gage is on the right side.

2.93 PARKING.

The methods used to secure the helicopter for temporary periods of time will vary with the local commands. The minimum requirements for parking are: gust lock engaged and wheel brakes set, tailwheel locked, and wheels properly chocked. For extended periods of time, engine inlet covers, exhaust covers, and pitot covers should be installed, and stabilator slewed to 0°. When required, the ignition system and the doors and window should be locked.

2.94 PROTECTIVE COVERS AND PLUGS.

The covers and plugs (Figure 2-26) protect vital areas from grit, snow, and water. The protected areas are avionics compartment air inlet, engine air inlet/accessory bay, engine and APU exhausts, pitot tubes, IRCM transmitter and APU air inlet and main transmission oil cooler exhaust. Covers and plugs should be installed whenever the helicopter is to be on the ground for an extended period of time. Each cover may be installed independently of the others.

2.95 MOORING.

Mooring fittings are installed at four points on the helicopter (Figure 2-26). Two fittings are at the front of the fuselage, one above each main landing gear strut, and two

at the rear, one attached to each side of the aft transition section. These fittings are used to tie down the helicopter when parked, and wind conditions require it.

2.95.1 Mooring Instructions. Refer to TM 1-1500-250-23 for mooring instructions.

2.95.2 Main Rotor Tiedown. Tiedown of the main rotor should be done when the helicopter will be parked for a period of time or when actual or projected wind conditions are 45 knots and above. To tiedown main rotor blades, do this:

1. Turn rotor head and position a blade over centerline of helicopter. Install tiedown fitting into receiver while pulling down on lock release cable. Release cable when fitting is installed in blade receiver.
2. Uncoil tiedown rope.

3. Repeat steps 1. and 2. for each remaining blade.
4. Turn blade to about 45° angle to centerline of helicopter and engage gust lock.



Do not deflect main rotor blade tips more than 6 inches below normal droop position when attaching tiedowns. Do not tie down below normal droop position.

5. Attach tiedown ropes to helicopter as shown in Figure 2-26. To release tiedown fitting, pull down on lock release cable and remove fitting from blade.

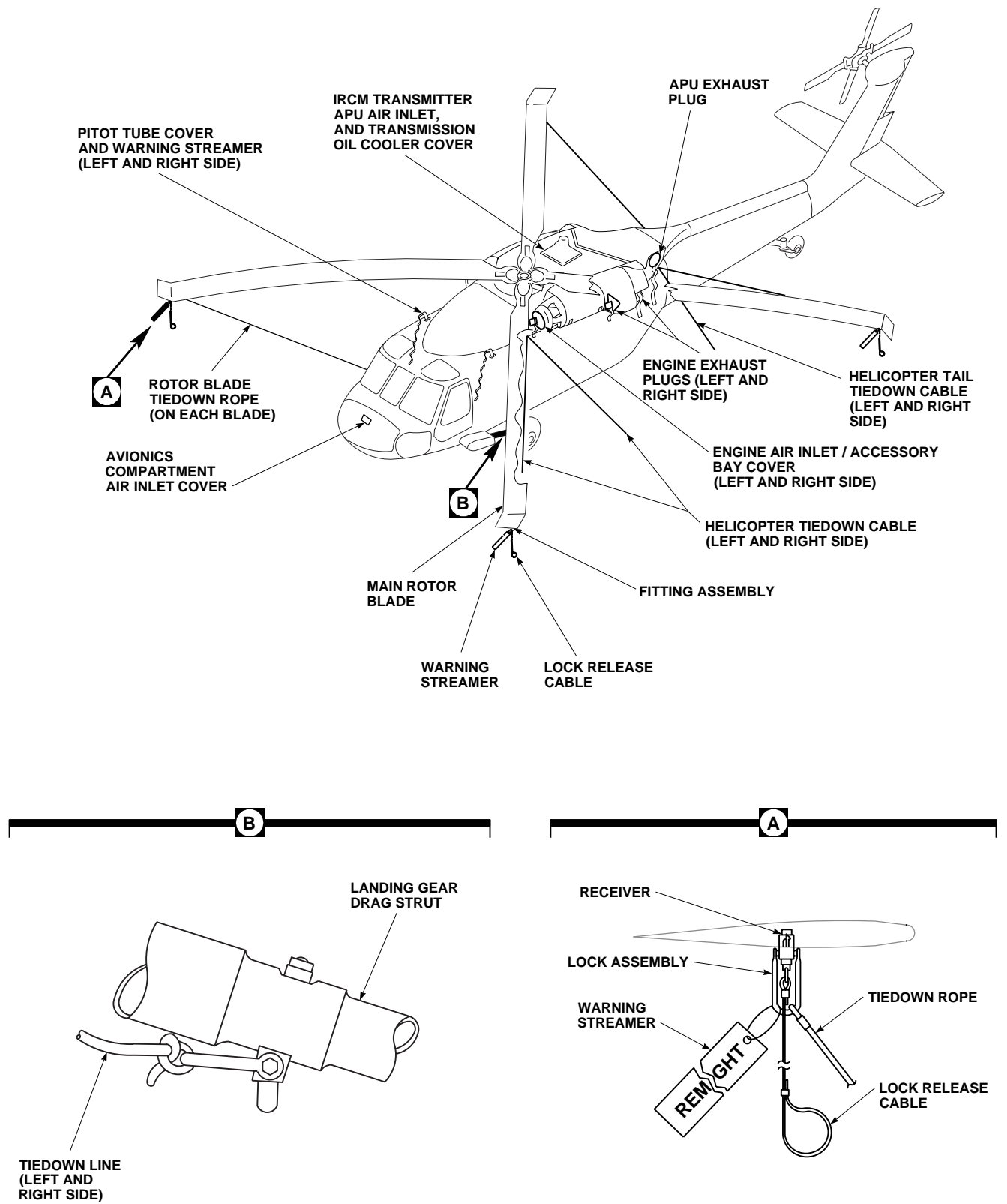

AA0522A
SA

Figure 2-26. Mooring

CHAPTER 3 AVIONICS

Section I GENERAL

3.1 DESCRIPTION.

The avionics subsystem consist of the communications equipment providing VHF-AM, VHF-FM, and UHF-AM communications. The navigation equipment includes, LF-ADF, VOR, ILS, marker beacon, Doppler **UH**, Doppler/GPS **UH**, or Integrated Inertial Navigation System **EH** VHF-FM homing is provided through the No. 1 VHF-FM communication radio. Transponder equipment consists of a receiver-transmitter with inputs from barometric altimeter for altitude fixing. Absolute height is provided by a radar altimeter. Each antenna will be described with its major end item, and locations as shown in Figure 3-1.

3.2 AVIONICS EQUIPMENT CONFIGURATION.

Equipment configuration is as shown in Table 3-1.

3.3 AVIONICS POWER SUPPLY.

Primary power to operate the avionics systems is provided from the No. 1 and No. 2 dc primary buses and the dc essential bus, and No. 1 and No. 2 ac primary buses (Figure 2-20). When operating any of the avionics equipment, helicopter generator output must be available or external ac power connected. Function selector switches should be at **OFF** before applying helicopter power.

Table 3-1. Communication/Navigation Equipment

FACILITY	NOMEN- CLATURE	USE	RANGE	CONTROL LOCATION	REMARKS
Intercommuni- cation system	Interphone control C-6533/ ARC	Intercommunication between crew- members and control of navigation and communication radio.	Stations within heli- copter	Cockpit lower console, crewchief/ gunner's stations and troop com- mander's station at center of cabin overhead with handset	

Table 3-1. Communication/Navigation Equipment (Cont)

FACILITY	NOMEN- CLATURE	USE	RANGE	CONTROL LOCATION	REMARKS
FM communi- cations (If in- stalled) UH	Radio set AN/ARC- 114A VHF-FM No. 1	Two-way voice communications; FM and continuous-wave homing frequency range 30 through 75.95 MHz.	*Line of sight	Lower console	FM No. 1 transmitter may be used only in heli- copters serial No. 79-23273 and subse- quent and those helicop- ters modified by MOD 99- 122 and 99- 122-1.
FM communi- cations (If in- stalled) UH	Radio Set AN/ARC- 114A VHF-FM No. 2	Same as No. 1 VHF-FM, except no homing is provided.		Lower console	
VHF commu- nications (If installed) UH	Radio Set AN/ARC- 115A VHF-AM	Two-way voice communications in the frequency range of 116.000 through 149.975 MHz.	*Line of sight	Lower console	Radio Set AN/ ARC-115 may be installed on some helicop- ters.
VHF AM and FM communi- cations (If in- stalled)	Radio Set AN/ARC- 186(V) VHF- AM/FM	Two-way voice communications in the frequency range 30.0 through 87.975 MHz and 116.0 through 151.975 MHz range. 108.0 through 115.975 MHz receive only.	*Line of sight	Lower console UH , ECM opera- tor's station EH	VHF-FM No. 2 Provisional.
FM communi- cations	Radio Set AN/ARC- 201 VHF-FM	Two-way voice communications, homing, frequency hopping in 30.0 - 87.975 MHz range.	*Line of sight	Lower console	VHF-FM No. 1/2 and MEP VHF-FM.
Improved Fre- quency Modu- lation Ampli- fier	IFM Am- plifier AM- 7189A/ ARC	Variable RF power amplifier; in- creases output from FM 1 (2.5, 10 or 40 watts out.)		FM 1 ARC-201 control box	Amplifier con- trol C-11188A used only when ARC- 186 is in- stalled EH .

Table 3-1. Communication/Navigation Equipment (Cont)

FACILITY	NOMEN- CLATURE	USE	RANGE	CONTROL LOCATION	REMARKS
UHF commu- nications	Radio- Transmitter Radio, RT- 1167/ARC- 164(V) UHF-AM	Two-way voice communications in the frequency range of 225.000 to 399.975 MHz.	*Line of sight	Lower console UH , DF opera- tor's station EH	
	Radio, RT- 1167C/ ARC- 164(V) UHF-AM	HAVE QUICK		Lower console UH	
	Radio, RT- 1614/ARC- 164(V) UHF-AM	HAVE QUICK II		Lower console UH	
Tunable di- plexer EH	TD-1336/A	Allows narrow band use of guard channel.		Beneath seat of copilot	
High fre- quency com- munications	Radio Set AN/ARC- 220	Two way voice communications in the frequency range of 2 to 29.9999 MHz.	*Over the horizon	Lower console UH	
Voice security system	TSEC/ KY-58	Secure communications.	Not appli- cable	Lower console	Can be used with FM1, FM2 and UHF-AM.
Voice security system	TSEC/KY- 100	Secure communications.	Not appli- cable	Rear lower con- sole	Used with HF AN/ARC-220.
Automatic di- rection finding	Direction Finder Set AN/ ARN-89 (if installed) AN/ARN- 149(V) (if installed)	Radio range and broadcast recep- tion; automatic direction finding and homing in the frequency range of 100 to 3000 kHz.	*50 to 100 miles range signals.	Lower console	AN/ARN- 149(V) tun- able, 100 to 2199.5 kHz.

Table 3-1. Communication/Navigation Equipment (Cont)

FACILITY	NOMEN- CLATURE	USE	RANGE	CONTROL LOCATION	REMARKS
VOR/LOC/ GS/MB re- ceiving set	Radio Re- ceiving Set AN/ARN- 123(V) (if installed) AN/ARN- 147(V) (if installed)	VHF navigational aid, VHF audio reception in the frequency range of 108 to 117.95 MHz and marker beacon receiver operating at 75 MHz.	*Line of sight	Lower console	AN/ARN- 147(V) tun- able, 108 to 126.95 kHz.
Doppler navi- gation set UH	Doppler Navigation Set AN/ ASN-128	Provides present position or desti- nation navigation information in latitude and longitude (degrees and minutes) or Universal Transverse Mercator (UTM) coordinates.		Lower console	
Doppler/GPS navigation set UH	Doppler/ GPS Navi- gation Set AN/ASN- 128B	Provides present position or desti- nation navigation information in latitude and longitude (degrees and minutes) or Military Grid Refer- ence System (MGRS) coordinates. Combined Mode is prime (default) mode of operation where the GPS updates Doppler present position. When Doppler is in memory (if not available), the system switches to GPS only mode. If GPS is jammed and/or becomes unavailable, the system automatically switches to the Doppler only mode. These modes of operation may also be se- lected manually.		Lower console	Doppler ONLY or GPS ONLY navi- gation is se- lectable from CDU.
Integrated In- ertial Naviga- tion System (IINS) EH	AN/ASN- 132(V)	Navigational Aid.		Lower console	
Magnetic heading indi- cations	Gyro Mag- netic Com- pass AN/ ASN-43	Navigational Aid.		Lower console	
Identification friend or foe	Transpon- der Set AN/ APX- 100(V)	Transmits a specially coded reply to a ground-based IFF radar Inter- rogator system.	*Line of sight	Lower console	

Table 3-1. Communication/Navigation Equipment (Cont)

FACILITY		NOMEN- CLATURE	USE	RANGE	CONTROL LOCATION	REMARKS
Absolute altimeter	al-	Radar Al- timeter AN/ APN-209	Measures absolute altitude.	0 to 1500 feet	Instrument panel	

NOTE

*Range of transmission or reception depends upon many variables including weather conditions, time of day, operating frequency, power of transmitter and altitude of the helicopter.

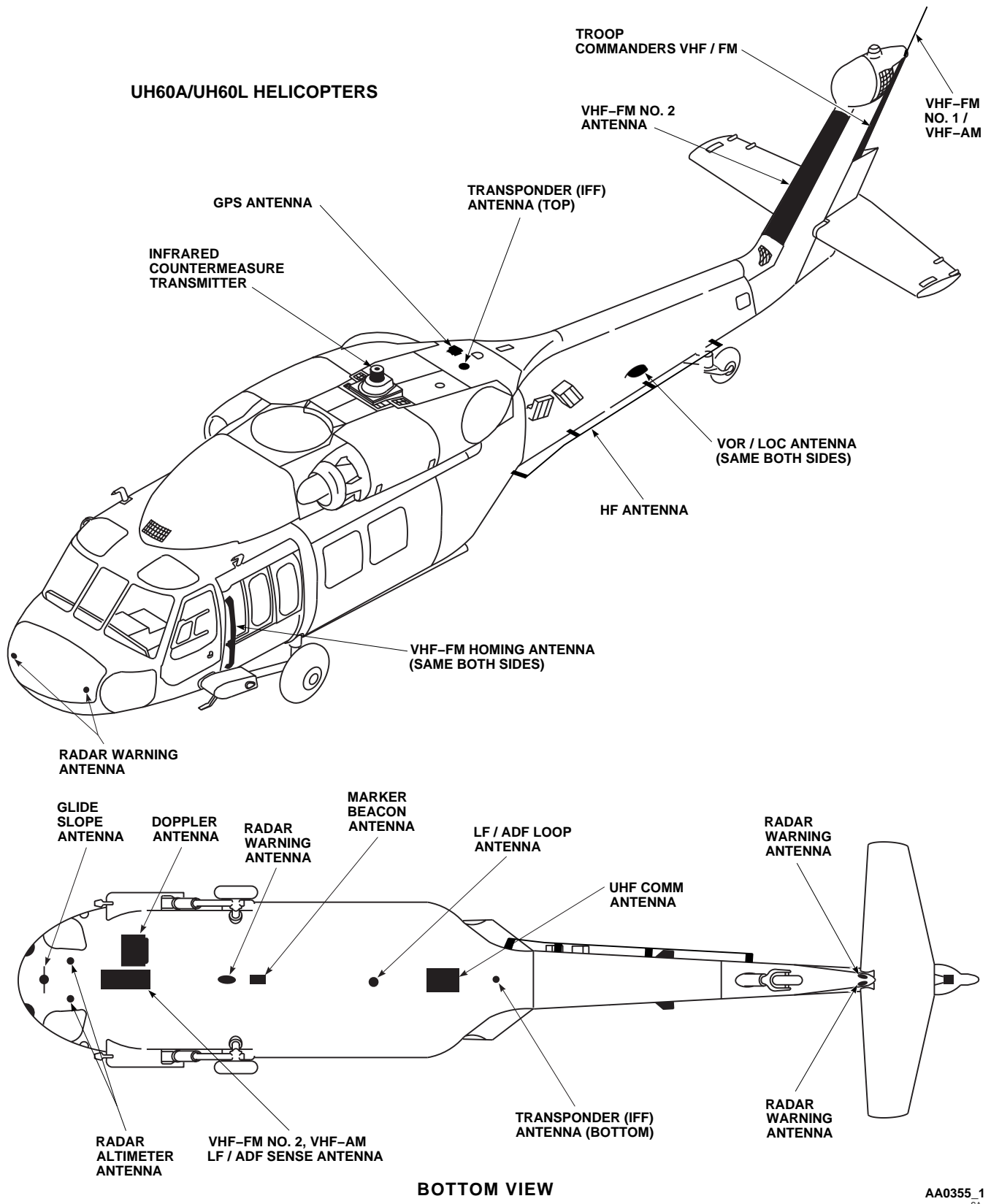

Figure 3-1. Antenna Arrangement (Sheet 1 of 2)

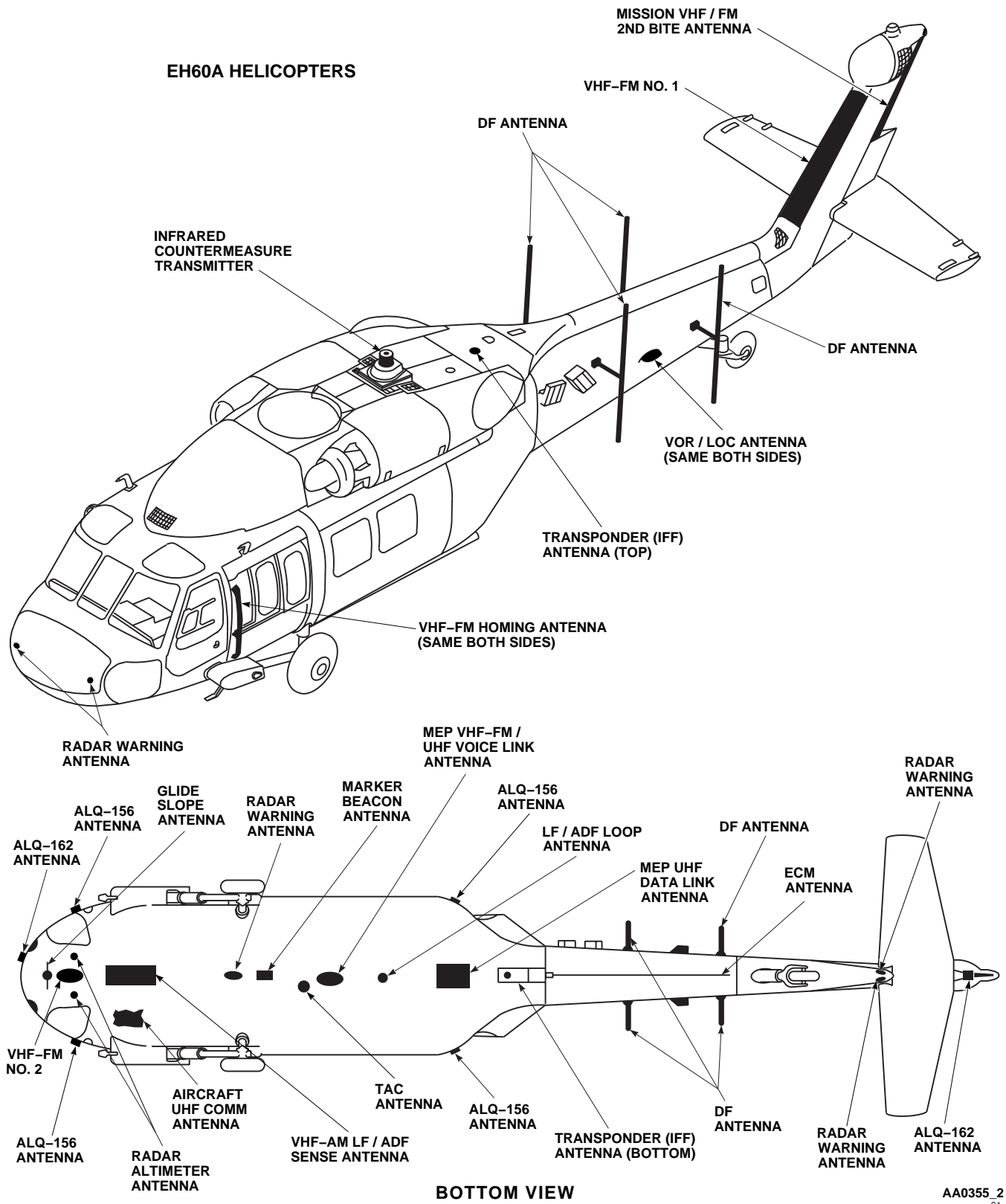

Figure 3-1. Antenna Arrangement (Sheet 2 of 2)

Section II COMMUNICATIONS

3.4 INTERCOMMUNICATION SYSTEM C-6533() /ARC.

Five intercommunication system (ICS) controls provide interior intercommunication capability between crew members and with the troop commander's position. They also provide a means by which the pilot and copilot may select and control associated radio equipment for voice transmission and reception. Additional audio circuits may also be selected for constant monitoring. When the communication control is operated in conjunction with equipment listed in Table 3-1, it is used to select associated radio equipment for voice operations. The operator may select any one of five transmitters (Figure 3-2), and/or any or all of five receivers to monitor. Four direct-wired audio circuits allow continuous monitoring. Hands-free intercommunication is provided by a hot mike feature. An exterior jack is to the front and below each gunner's window. When the walkaround cord is connected to it, the crewchief can communicate with the interior of the helicopter or with the other exterior jack through the crewchief/gunner's control panels. A placard installed on the instrument panel and above each troop-cargo compartment ICS station control panel indicates which receiver is selected when a selector switch is placed ON. Power for the intercommunication system is provided from the dc essential bus through circuit breakers, marked **ICS PILOT** and **ICS COPILOT**.

3.4.1 Controls and Functions. Controls for the intercom/radios are on the front panel of the unit (Figure 3-2). The function of each control is as follows:

CONTROL/ INDICATOR	FUNCTION
Receiver selector switches (ON)	
1	Connects FM 1 receiver to the headphone.
2	Connects UHF receiver to the headphone.
3	Connects VHF receiver to the headphone.
4	Connects FM 2 receiver to the headphone.
5	Connects HF receiver to the headphone.
AUX	Connects VOR/LOC audio to the headphone.

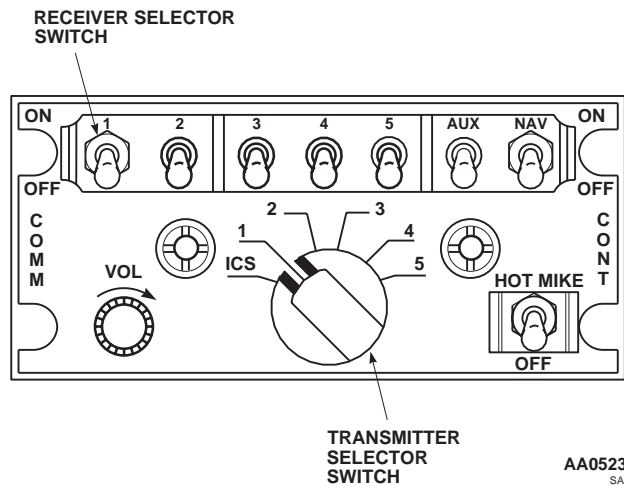

Figure 3-2. Intercommunication Control Panel C-6533/ARC

CONTROL/ INDICATOR	FUNCTION
NAV	Connects ADF/Marker Beacon audio to the headphone.
VOL control	Adjusts headphone volume level.
Transmitter selector switch	
ICS	Enables intercom operation when keyed.
1	Enables FM 1 transmission when keyed.
2	Enables UHF transmission when keyed.
3	Enables VHF transmission when keyed.
4	Enables FM 2 transmission when keyed (provisions).
5	Enables HF transmission when keyed.
HOT MIKE switch	Enables intercom transmission without manual key.

3.4.2 Intercommunication Keying System. Keying of the ICS system is done by these controls:

- a. Pilot or copilot station. An **ICS** or **RADIO** switch on the top of each cyclic stick, or by a switch on the floor at the pilot's left and the copilot's right foot (Figure 2-4).

b. Crewchief/Gunner and Left Gunner. A pushbutton at the end of the ICS cord or the exterior walkaround cord, and foot switches on each side of the helicopter at the crewchief/gunner's and left gunner's station.

c. Troop commander. A push switch on the handset at the troop commander's station.

3.4.3 Modes of Operation.

3.4.3.1 Primary Operation Check. There are several methods of intercommunication operation. In all cases, no operator action is required to receive intercom signals other than adjusting the **VOL** control for a comfortable level at the headset.

3.4.3.2 Intercommunication (All Stations).

1. Transmitter selector switch **ICS** for pilot and copilot when using foot switch, any position when using cyclic switch, **ICS** for crewchief/gunner, gunner, and troop commander.
2. Key switch - **ICS** switch on pilot's or copilot's cyclic, or foot switch at pilot's, copilot's or crewchief/gunner, gunner positions, or push-to-talk button on crewchief/gunner's ICS cord, push-to-talk switch on troop commander handset press, speak into microphone and listen for sidetone, release to listen.

3.4.3.3 External Radio Communication. All stations of the helicopter are capable of external radio communications.

3.4.4 Pilot and Copilot.

1. Transmitter selector - Desired position, **1** through **5**.
2. **RADIO** push-to-talk switch on cyclic stick, or foot-operated push-to-talk switch - Press; speak into microphone while holding switch; release to listen.

3.4.4.1 Crewchief/Gunner.

1. Transmitter selector - Desired position, **1** through **5**.
2. Push-to-talk switch on headset-microphone cord, or foot-operated push-to-talk switch - Press, speak into microphone while holding switch, release to listen.

3.4.4.2 Troop commander.

1. Transmitter selector - Desired position **1** through **5**.
2. Transmitter key switch on handset - Press, speak into microphone while holding switch, release to listen.

3.4.5 Receiver Selection.

1. Receiver selector switch(es) - **ON** as desired.
2. Adjust volume to a comfortable listening level.

3.5 RADIO SET AN/ARC-114A(VHF-FM) **UH** .

Radio Sets AN/ARC-114A (Figure 3-3) is an airborne, very high frequency (VHF), frequency-modulated (FM), radio receiving-transmitting set that is compatible with the narrow band series of ground tactical radios. The radio set contains a multichannel, electronically tunable main receiver and transmitter, a fixed-tuned guard receiver, and has a homing capability. The main receiver and transmitter operate on any one of 920 channels in the 30.00 MHz to 75.95 MHz frequency range. The guard receiver is fixed tuned in the 40.0 MHz to 42.0 MHz frequency range. The radio set, when operated in conjunction with voice security equipment, is used for receiving and transmitting clear-voice or **X**-mode communications. An additional capability for retransmission of clear voice communication allows use of the radio set as a relay link. During retransmission, when the one radio receives a signal, it sends a keying signal to the second radio and the first radio's received audio modulates the second radio's transmitter. Use of the homing capability of the No. 1 FM radio set provides a steering output to the VSI course deviation pointer for steering indications. No. 1 VHF-FM receives power from the dc essential bus through a circuit breaker marked **NO. 1 VHF-FM**. When installed, No. 2 VHF-FM receives power from the No. 1 dc primary bus through a circuit breaker marked **NO. 2 VHF-FM**.

3.5.1 Antennas. The VHF/FM antenna arrangements (Figure 3-1) are: The FM No. 1 communication antenna is within the leading edge pylon drive shaft cover. FM No. 2 communication antenna is under the nose section and is shared with operation of other radio sets. The FM homing antennas, one on each side of the fuselage, are used with the FM No. 1 radio set. The troop commander's antenna is on the upper trailing edge of the tail pylon. Refer to Chapter 4, Section I for use of troop commander's antenna.

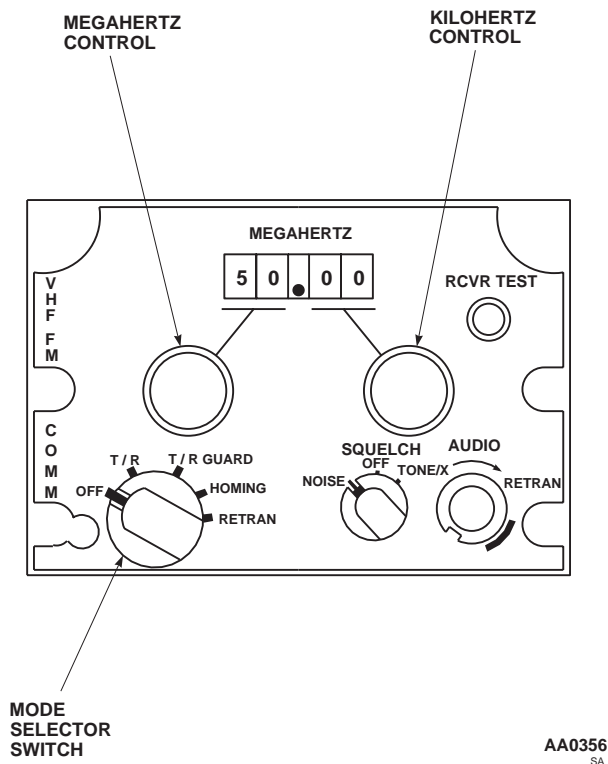

Figure 3-3. FM Control AN/ARC-114A

3.5.2 Controls and Functions. Controls for the AN/ARC-114A transceiver are on the front panel of the unit (Figure 3-3). The function of each control is as follows:

CONTROL	FUNCTION
MEGAHERTZ indicator	Indicates frequency to which main receiver/ transmitter is tuned. (Guard receiver is fixed tuned.)
1 Megahertz control	Tunes main receiver/ transmitter in 10-MHz and 1-MHz steps as indicated by first two digits of MEGAHERTZ indicator. (Guard receiver is fixed tuned.)
Kilohertz control	Tunes main receiver/ transmitter in 100-kHz and 50-kHz steps as indicated by last two digits of MEGAHERTZ indicator. (Guard receiver is fixed tuned.)
RCVR TEST pushbutton	When pressed, injects a signal into main receiver to audibly indicate proper main receiver performance.

CONTROL	FUNCTION
SQUELCH switch	Disables squelch
OFF	
NOISE	Activates noise squelch
TONE/X	Activates tone squelch for secure voice mode.
Mode selector switch	Turns set on or off and determines operating mode of radio set:
OFF	Removes power from radio set.
T/R	Provides for radio set operation as a transceiver on main channels indicated on MEGAHERTZ indicator.
T/R GUARD	Same as T/R above plus reception on guard channel. T/R GUARD mode is used when it is desired to monitor a preset frequency within 40.00 to 42.00 MHz band, usually 40.50 MHz, and also operate main transmitter/receiver as a communications unit.
HOMING	Provides for radio set operation in homing mode. May also be operated as a transceiver on main channels indicated on MEGAHERTZ indicator.
RETRAN	Provides for retransmit operation when used to relay a signal from another source. May also be operated as a transceiver on main channels indicated on MEGAHERTZ indicator.
AUDIO control	Adjusts radio set volume. Control is set to white RETRAN segment for proper audio output during retransmission operation.

3.5.3 Operation.

3.5.3.1 Modes of Operation. Depending on the settings of the operating controls, the radio set can be used for these modes of operation:

- a. Two-way voice, normal (**T/R**).
- b. When voice security system is installed, refer to paragraph 3.11.
- c. Constant monitoring of guard channel without losing main receiver use (**T/R GUARD**).
- d. Homing.
- e. Retransmit (**RETRAN**).

3.5.3.2 Starting procedure. The radio set is capable of operating in any of the four modes indicated by the mode selector switch (Figure 3-3).

3.5.3.3 Transmit/Receive (T/R) Mode.

1. Mode selector - **T/R** or **T/R GUARD**.
2. Frequency - Select.
3. ICS transmitter selector - Position **1** (FM No. 1), or position **4** (FM No. 2).
4. Radio push-to-talk switch - Press to talk; release to listen.

3.5.3.4 T/R GUARD Mode.

1. Mode selector - **T/R GUARD**.
2. Frequency - Select.
3. ICS transmitter selector - Position **1** (FM No. 1), or position **4** (FM No. 2).
4. Radio push-to-talk switch - Press to talk; release to listen.

NOTE

If reception on selected frequency is interfering with guard reception, detune set(s) by selecting an open frequency. This condition permits only the priority guard channel to be monitored.

3.5.3.5 Homing Mode (FM No. 1 only).

1. Frequency - Select.
2. Mode selector switch - **HOMING**.
3. **MODE SEL - FM HOME**.
4. **CIS MODE SEL - NAV**.
5. Observe homing indications on vertical situation indicator (VSI) (Figure 3-30). These are:
 - a. FM navigation (**NAV**) flag will move from view, and will come into view if the received signal is too weak.
 - b. A steering (course deviation) pointer moves either left or right about 5° to indicate any deviation from the course to the transmitting station.
 - c. Station passage will be indicated by course deviation change and **CIS MODE SEL NAV** switch light going out and **HDG** switch light going on.

3.5.3.6 RETRAN (Retransmission) Mode. Retransmission permits the helicopter to be used as an airborne relay (Figure 3-12).

1. Mode selector - **RETRAN**.
2. **AUDIO** Control - Set to **RETRAN**.
3. Frequency(s) - Select.
4. **RADIO RETRANSMISSION** selector switch - Set to radios used.
5. Establish communication between each relay radio in helicopter and its counterpart radio at terminal station by using appropriate **ICS TRANS** selector. If audio monitoring is desired, adjust **AUDIO** control for a suitable output. AN/ARC-114A and AN/ARC-115A radios have a predetermined mark on **AUDIO** control for retransmission audio level.

3.5.4 Stopping Procedure. Mode selector - OFF.

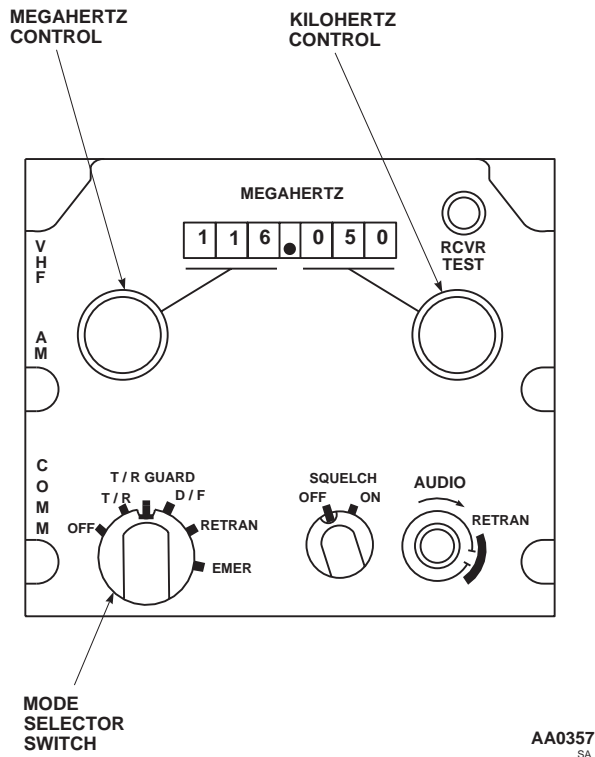

Figure 3-4. VHF Control AN/ARC-115A

3.6 RADIO SET AN/ARC-115A (VHF-AM) **U1..**

NOTE

Radio Set AN/ARC-115 may be installed on some helicopters. Appearance and operation is the same as the Radio Set AN/ARC-115A, except, the mode selector switch does not have an **EMER** position, and the **SQUELCH** operation is not controlled from the cockpit.

The radio set AN/ARC-115A (Figure 3-4) is a light-weight multichannel airborne radio communication set, which provides transmission, reception, and retransmission of amplitude modulated (am) radio communications. The radio set contains a multichannel, tunable main receiver and transmitter which operates on any one of 1,360 discrete channels, each spaced 25 kHz within the frequency range of 116.000 through 149.975 MHz. The fixed guard channel receiver operates in the 119.000 through 124.000 MHz frequency range, with the preset crystal control normally at 121.500 MHz, the guard (emergency) frequency. Power to operate the AN/ARC-115A is from the No. 2 dc primary bus through a circuit breaker marked **VHF AM**.

3.6.1 Antenna. The VHF/AM antenna is under the nose section (Figure 3-1). The antenna operation is shared with FM No. 2, and ADF sense.

3.6.2 Controls and Functions. Controls for the AN/ARC-115A are on the front panel of the unit (Figure 3-4). The function of each controls is as follows:

CONTROL	FUNCTION
MEGAHERTZ indicator	Indicates frequency to which the main transmitter/receiver is tuned (Guard receiver is fixed tuned).
1 Megahertz control	Tunes the main transmitter/receiver in 1 MHz steps as indicated by the first three digits of the MEGAHERTZ indicator.
Kilohertz control	Tunes the main transmitter/receiver in 25-kHz steps as indicated by the last three digits of the MEGAHERTZ indicator.
RCVR TEST pushbutton	When pressed, injects a noise signal into the main receiver to audibly indicate proper receiver performance.
SQUELCH ON-OFF switch	Enables and disables squelch of main receiver.
AUDIO-RETRAN (Volume Control)	Adjusts radio set volume. Control is set to white RETRAN segment for proper audio output during retransmission operation.
Mode selector switch	Turns set on or off and determines operating mode of radio set.
OFF	Turns power off.
T/R	Provides for radio set operation as a transceiver on main channels as indicated on MEGACYCLE indicator.
T/R GUARD	Same as T/R above plus reception on guard channel.
D/F	D/F mode is not used in this installation.

CONTROL	FUNCTION
RETRAN	Provides for retransmit operation when used to relay a signal from another source. May also be operated as a transceiver on main channel indicated on MEGACYCLE indicator.
EMER	Disables multichannel receiver and enables transmit and receive on guard (EMER) frequency. Blocks out frequency selected on MEGAHERTZ indicator.

3.6.3 Modes of Operation. Depending on the settings of the operating controls, the radio set can be used for these modes of operation.

- a. Two-way voice, normal (**T/R**).
- b. When voice security system is installed, refer to paragraph 3.11.
- c. Constant monitoring of guard channel (121.5 MHz), without losing main receiver use (**T/R GUARD**).
- d. Retransmit (**RETRAN**).
- e. Guard receive and transmit only (**EMER**).

3.6.3.1 Starting Procedure. Before starting radio set, check settings of controls that pertain to communications equipment. With dc power applied, radio set is turned on with mode selector (Figure 3-4) in any position other than **OFF** or **EMER**.

3.6.3.2 Operation.

3.6.3.3 Transmit/Receive (T/R) Mode.

1. Mode Selector - **T/R** or **T/R GUARD**.
2. Frequency - Select.
3. ICS transmitter selector - Position **3**.
4. Radio push-to-talk switch - Press to talk; release to listen.

3.6.3.4 Transmit/Receive Plus GUARD (T/R GUARD) Mode. The **T/R GUARD** mode of operation is used when it is desired to monitor a frequency within the

119.000 to 124.000 MHz band, usually 121.500 MHz distress frequency. Transmission on this frequency should be limited to emergency use only. When emergency conditions occur, the main transceiver must be tuned to the distress frequency, or function switch placed to **EMER**.

1. Mode selector - **T/R GUARD**.
2. Frequency - Select.

NOTE

If reception on the selected frequency is interfering with guard reception, detune the set by selecting an open frequency, or place the mode switch to **EMER**.

3. ICS transmitter selector - Position **3**.
4. Radio push-to-talk switch - Press to talk; release to listen.

3.6.3.5 Retransmit (RETRAN) Mode.

1. Mode selector - **RETRAN**.
2. AUDIO control - Set to **RETRAN**.
3. Frequency - Select.
4. **RADIO RETRANSMISSION** selector switch - Set to radios to be used.
5. Establish communication between each relay radio in helicopter and its counterpart radio at terminal station by using appropriate **ICS** transmitter selector.

3.6.3.6 Emergency (EMER) Operation.

1. Mode selector - **EMER**.
2. **ICS** transmitter selector - Position **3**.
3. Radio push-to-talk switch - Press to talk; release to listen.

3.6.4 Stopping Procedure. Mode Selector - **OFF**.

3.7 RADIO SET AN/ARC-186(V).

Radio Set AN/ARC-186(V) (Figure 3-5) is a lightweight multichannel airborne radio communications set, which provides transmission, reception and retransmission of amplitude modulated (AM), frequency modulated (FM) radio

communications, and FM directional finding (homing) with installation of other associated equipment. AM reception only is provided on frequencies between 108.000 and 115.975 MHz. Installation of the AN/ARC-186(V) in the UH-60A helicopter is a VHF-AM and/or VHF-FM installation(s). The transceiver has a tunable main receiver and transmitter which operates on any one of 1,469 AM discrete channels, each spaced 25 kHz apart within the frequency range of 116.000 through 151.975 MHz, or 30.000 through 87.975 MHz FM, providing 2,319 channels. FM homing operations within the 30 through 87.975 MHz band. The fixed guard channels are between 116.000 and 151.975 MHz AM (usually 121.500 MHz), and between 30.000 and 87.975 MHz FM (usually 40.500 MHz). The guard frequencies are preset and only require selection by the frequency/emergency select switch. Frequencies can be preset for 20 channels. VHF-AM installations cannot be used to transmit VHF-FM signals. If an AM frequency is selected on an FM only installation, an audible tone would be heard, warning the pilot of an out-of-band frequency selection. The same is true in the case of selection of an FM frequency on an AM installation. Keying the microphone for voice transmission when in DF (homing) mode will disable the homing function while the mic is keyed. In DF mode, audio reception is distorted. When using secured speech and **EMER FM** or **AM** is selected, secure speech function will be disabled to enable normal voice communications. Power to operate the AN/ARC-186(V) radio is provided from the No. 2 dc primary bus through a circuit breaker, marked **VHF-AM** for the AM radio, and from the No. 1 and No. 2 dc primary buses, respectively, through circuit breakers marked **NO. 1 VHF-FM** and **NO. 2 VHF-FM** for the No. 1 and No. 2 VHF-FM radios.

3.7.1 Antennas.

a. **UH**The VHF-AM antenna is on top of the tail rotor pylon (Figure 3-1). The antenna operation is shared with No. 1 VHF-FM. The No. 2 VHF-FM communications antenna is within the leading edge fairing of the tail pylon drive shaft cover. The two FM homing antennas used with the No. 1 VHF-FM radio are on each side of the helicopter fuselage, just behind the cockpit doors.

b. **EH**The VHF-AM antenna is under the nose section (Figure 3-1). The antenna operation is shared with ADF sense. No. 1 VHF-FM communications antenna is within the leading edge fairing of the tail pylon drive shaft cover. No. 2 VHF-FM communications antenna is under the nose, forward of VHF-AM antenna. The two FM homing antennas used with the No. 1 VHF-FM radio are on each side of the helicopter fuselage, just behind the cockpit doors.

3.7.2 Controls and Functions. Controls for the AN/ARC-186(V) are on the front panel of the unit (Figure 3-5). The function of each control is as follows:

CONTROL	FUNCTION
0.025 MHz selector	Rotary switch. Selects rt frequency in 0.025 MHz steps. Clockwise rotation increases frequency.
0.1 MHz selector	Rotary switch. Selects rt frequency in 0.1 MHz steps. Clockwise rotation increases frequency.
1.0 MHz selector	Rotary switch. Selects rt frequency in 1.0 MHz steps. Clockwise rotation increases frequency.
10 MHz selector	Rotary switch. Selects rt frequency in 10 MHz steps from 30 to 150 MHz. Clockwise rotation increases frequency.
Preset channel selector	Selects preset channel from 1 to 20. Clockwise rotation increases channel number selected.
Volume control	Potentiometer. Clockwise rotation increases volume.
Squelch disable/tone select	Three-position switch. Center position enables squelch, SQ DIS position disables squelch, momentary TONE position transmits tone of approximately 1000 Hz.
Frequency control/emergency select switch	Four-position rotary switch. PRE position enables preset channel selection, MAN position enables manual frequency selection, EMER AM or FM selects a prestored guard channel (FM not used in helicopters with panel-mounted transceiver).
Mode select switch	NOTE Selecting EMER AM or FM automatically disables the secure speech function and enables normal voice communication. Three-position rotary switch. OFF position disables receiver/transmitter, TR position enables transmit/receive modes. DF position enables FM homing.

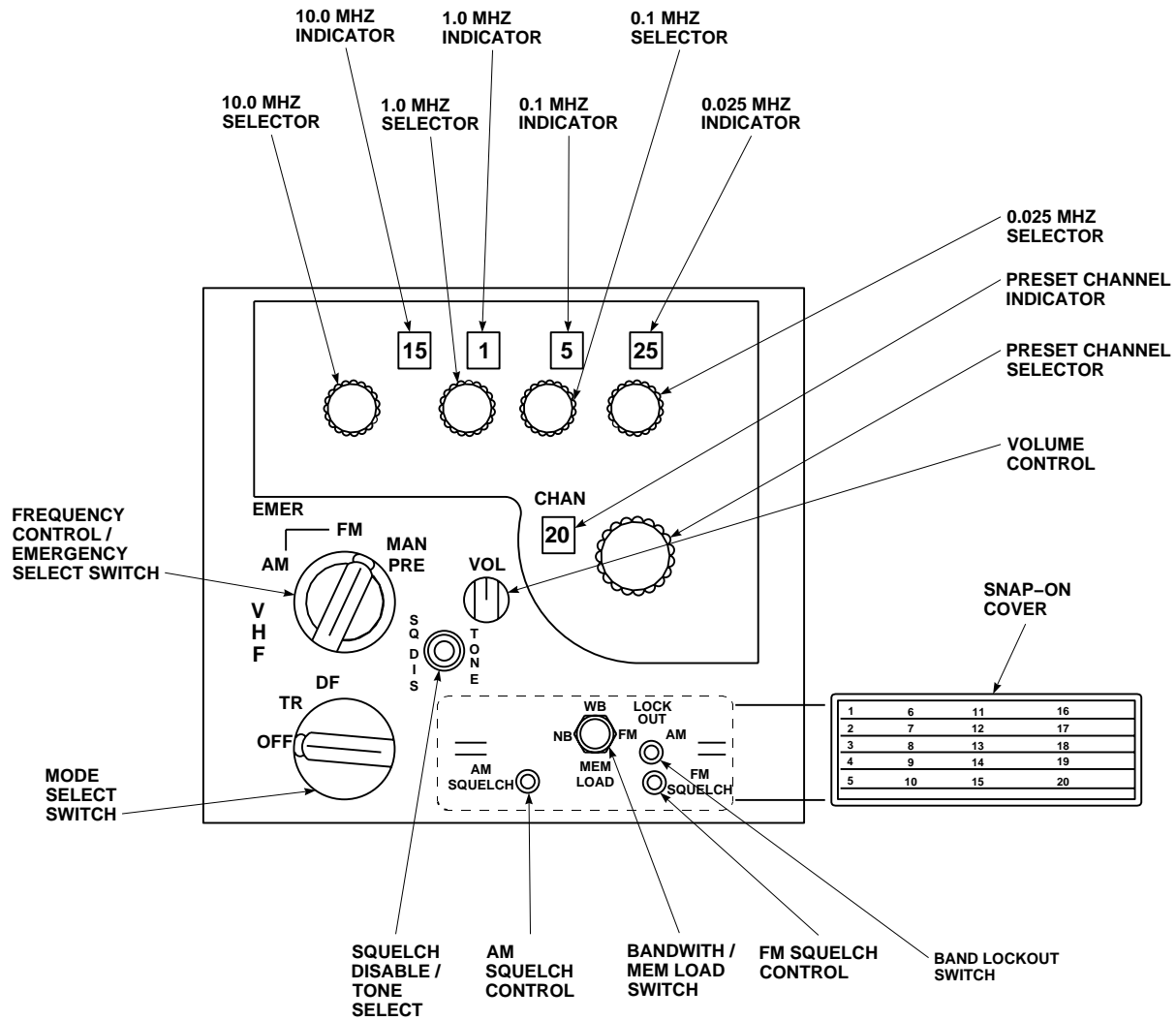

(PANEL-MOUNTED TRANSCEIVER)

AA0361_1
SA

Figure 3-5. VHF Control AN/ARC-186(V) (Sheet 1 of 2)

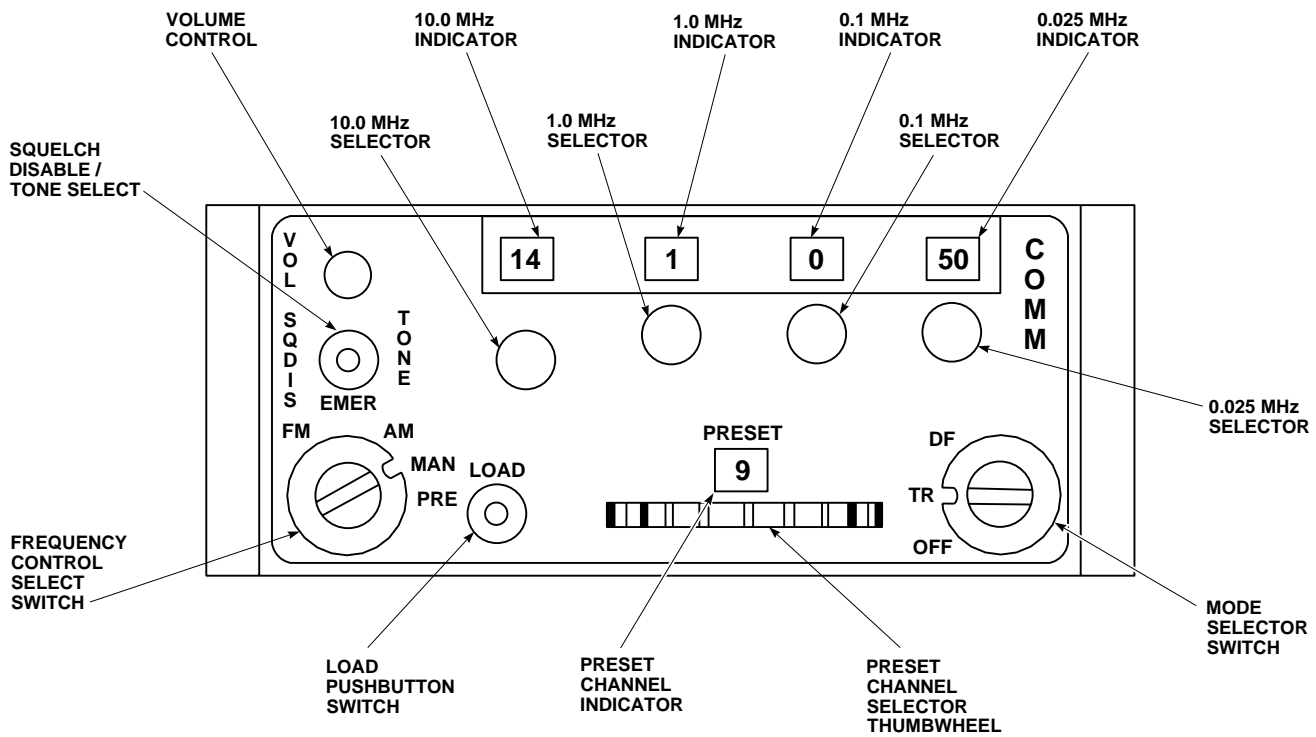

AA0361_2A
SA

Figure 3-5. VHF Control AN/ARC-186(V) (Sheet 2 of 2)

CONTROL

FUNCTION

BANDWIDTH/MEM LOAD (On helicopters with panel-mounted transceiver). On helicopters with half-size remote control panel, the memory switch is labeled **LOAD**. Bandwidth switch is inaccessible.

Three-position switch **NB** (NARROW) position enables narrowband selectivity **WB** (WIDE) enables wideband selectivity in the FM band, momentary **MEM LOAD** position allows manually selected frequency to go into selected preset channel memory.

AM SQUELCH control (On helicopters with panel-mounted transceiver). (Use of control is a maintenance function).

Screwdriver adjustable potentiometer. Squelch overridden at maximum counterclockwise position, clockwise rotation increases input signal required to open the squelch.

CONTROL

FUNCTION

FM SQUELCH Screwdriver adjustable potentiometer. Squelch overridden at maximum counterclockwise position, clockwise rotation increases input signal required to open the squelch. (Use of control is a maintenance function).

(Use of control is a maintenance function).

BAND LOCK-OUT switch (On helicopters with panel-mounted transceiver). (Use of control is a maintenance function).

Screwdriver settable three-position switch. Center position enables both AM and FM bands, **AM** position locks out AM band, **FM** position locks out FM band. (Band lockout is indicated by a warning tone.)

3.7.3 Modes of Operation. Depending on the settings of the operation controls, the radio set can be used for these modes of operation:

- a. Two-way voice, normal (**TR**).
- b. When voice security system is installed, refer to paragraph 3.11.
- c. Constant monitoring of guard channel 121.5 MHz only.
- d. Guard receive and transmit only (**EMER**).

3.7.3.1 Starting Procedure. Before starting radio set, check settings of controls that pertain to communication equipment. With dc power applied, radio set is turned on with mode selector (Figure 3-5) in any position other than **OFF** or **EMER**.

3.7.3.2 Operational Check. Select mode and communicate with or direction to the ground station on selected frequencies in low, middle, and high range of applicable frequency band. Check the action of the volume control and note that the selected frequencies are heard loud and clear. Check that adequate sidetone is audible during all transmissions.

- a. Communications mode check:
 - (1) Mode select switch - **TR**.
 - (2) Select out-of-band frequency to check warning. (On helicopters with panel-mounted transceivers.)
 - (3) Select frequency of station to be used for check, **MAN** or **PRE** as desired.
 - (4) Communicate with check station.

NOTE

Transmitting with the AN/ARC-186 FM#2 radio may cause the LF-ADF (AN/ARN-89) bearing pointer to deflect and lose audio when tuned to a station 400 kHz or below. Releasing the transmitter key allows the LF-ADF receiver to return to the normal audio and bearing indication.

Transmitting with the AN/ARC-186 VHF/AM radio on frequencies from 120 MHz and above may cause the LF-ADF (AN/ARN-89) bearing pointer to deflect and lose audio when tuned to a station below 1500 kHz. Releasing the transmitter key allows the LF-ADF receiver to return to the normal audio and bearing indication.

- b. **DF** mode check.
 - (1) Select frequency of station to be used for homing.
 - (2) Mode select switch - **DF**.
 - (3) Frequency control select switch - **MAN** or **PRE** as desired.
 - (4) Check for homing indication.
- c. Squelch disable/tone check.
 - (1) Select **SQ DIS** - Check for noise.
 - (2) Select momentary **TONE**, check for tone of about 1000 Hz.
- d. Preset channel load.
 - (1) Mode select switch - **TR**.
 - (2) Frequency control select switch - **MAN**.
 - (3) Set MHz frequency for desired channel and rotate **PRESET** channel to number to be used with that frequency using channel selector thumbwheel.
 - (4) **LOAD** button - Press and release.
 - (5) Repeat steps 3. and 4. for other preset channels.

3.7.3.3 Operation.

3.7.3.4 TR Mode AM or FM as Applicable.

- 1. Set **OFF-TR-DF** switch to **TR**.
- 2. Set frequency control select switch to **MAN** or **PRE**.
- 3. Rotate four MHz selectors to desired frequency or set **PRESET** channel number as desired.

3.7.3.5 Emergency Mode AM or FM as Applicable.

- 1. Mode select switch - **TR** or **DF**.
- 2. Frequency mode selector switch - **EMER AM** or **FM** as applicable.

3.7.3.6 DF (Homing) Mode.

1. Mode select switch - **DF**.
2. Frequency control select switch - **MAN** or **PRE**.

3.7.3.7 Retransmission Mode. Do a retransmission check as follows:

NOTE

Do not disable squelch when retransmit switches are in retransmit position. Squelch level is used to key transmitter for retransmission.

1. Establish two base stations at unrelated frequencies.
2. Set appropriate receiver-transmitter to desired retransmit frequency.
3. Place **RADIO TRANSMISSION** selector switch to radios to be used.
4. Establish communication between base stations through aircraft radios.
5. Note that selected frequencies are heard loud and clear and that received audio is present and clear at each crew station.

3.7.4 Stopping Procedure. Mode Selector - **OFF**.

3.7.5 IFM Amplifier Control.

NOTE

IFM amplifier control installed in EH-60A helicopters with ARC-186 as VHF-FM No. 1 (Figure 3-6).

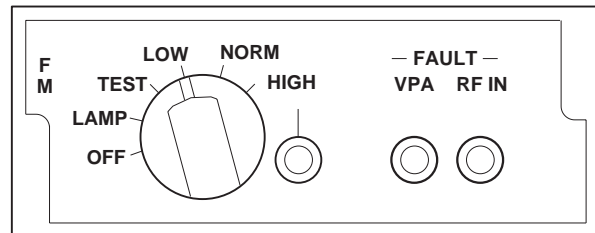

AA9242
SA

Figure 3-6. IFM Amplifier Control

CONTROL	FUNCTION
NORM	(Normal power) - 10 watts.
HIGH	(High power) - 40 watts.

3.8 RADIO SET AN/ARC-201 (VHF-FM) (IF INSTALLED).

Radio set AN/ARC-201 (Figure 3-7) is an airborne, very high frequency (VHF), frequency modulated (FM), radio receiving-transmitting set compatible with the Single Channel Ground Airborne Radio Sets (SINGCARS) Electronic Countermeasures (ECCM) mode of operation. The set provides communications of voice and data, secure or plain text, and homing over the frequency range of 30 to 87.975 MHz channelized in 25 Khz steps. A frequency offset tuning capability of -10 Khz, -5 Khz, +5 Khz and +10 Khz is provided in both transmit and receive mode; this capability is not used in ECCM mode. The set when used in conjunction with the TSEC/KY-58 equipment, is used for receiving and transmitting clear-voice or X-mode communications. An additional capability for retransmission of clear-voice communications allows use of the set as a relay link. During retransmission, when one radio receives a signal, it sends a keying signal to the second radio and the first radio's received audio modulates the second radio's transmitter. Use of the homing capability of the No. 1 FM radio set provides a steering output to the VSI course deviation pointer for steering indications. No. 1 VHF-FM receives power from the dc essential bus through a circuit breaker

CONTROL	FUNCTION
OFF	(Bypass amplifier) - 10 watts.
LAMP	Tests indicator lights.
TEST	Checks IFM amplifier.
LOW	(Low power) - 2.5 watts.

marked **NO. 1 VHF-FM**. No. 2 VHF-FM receives power from the No. 1 dc primary bus through a circuit breaker marked **NO. 2 VHF-FM**.

3.8.1 Antennas.

a. **UH**The No. 1 VHF-FM communications antenna is on top of the tail rotor pylon (Figure 3-1). The No. 2 VHF-FM antenna is within the leading edge fairing of the tail pylon drive shaft cover. The FM homing antennas, one on each side of the fuselage, are used with FM No. 1 radio set. The troop commander’s antenna is on the upper trailing edge of the tail pylon. Refer to Chapter 4, Section 1 for use of troop commander’s antenna.

b. **EH**The No. 1 VHF-FM communications antenna is within the leading edge fairing of the tail pylon drive shaft cover (Figure 3-1). The No. 2 VHF-FM antenna is under the nose section. The FM homing antennas, one on each side of the fuselage, are used with FM No. 1 radio set. the troop commander’s antenna in on the upper trailing edge of the tail pylon. Refer to Chapter 4, Section 1 for use of troop commander’s antenna.

3.8.2 Controls and Functions. Controls for the ARC-201 are on the front panel (Figure 3-7). The function of each control is as follows:

CONTROL	FUNCTION
OFF	Primary power off; Memory battery power ON.
TEST	RT and ECCM modules are tested, Results: GOOD or FAIL .
SQ ON	RT on with squelch.
SQ OFF	RT on with squelch disabled.
RXMT	RT is receiving. Used as a radio relay link.
LD	Keyboard loading of preset frequencies.
LD-V	TRANSEC variable loading is enabled.
Z-A	Pull and turn switch. (Not an operational position). Used to clear the TRANSEC variable.
STOW	Pull and turn switch. All power removed. Used during extended storage.

CONTROL	FUNCTION
MODE	
HOM	Homing antennas selected; communication antenna disconnected. Provides pilot with steering, station approach and signal strength indicators.
SC	Single Channel. Operating frequency is selected by PRESET switch or keyboard entry.
FH	Frequency Hopping. PRESET switch positions 1-6 select frequency parameters.
FH-M	Frequency hopping-master selects control station as the time standard for communicating equipment.
PRESET	
MAN	Used in single channel mode to select any operating frequency in 25 Khz increments.
Positions 1-6	In SC mode, preset frequencies are selected or loaded. In FH or FH-M mode, frequency hopping nets are selected.
CUE	Used by a non-ECCM radio to signal ECCM radio.
IFM RF PWR (VHF-FM No. 1 only)	
NOTE	
OFF	(Bypass amplifier) - 10 watts.
LO	(Low power) - 2.5 watts.
NORM	(Normal power) - 10 watts.
HI	(High power) - 40 watts.
VOL control	Adjust receiver volume to comfortable level.
KEYBOARD	
Switches 1-9	To key in any frequency, load time information or offsets.

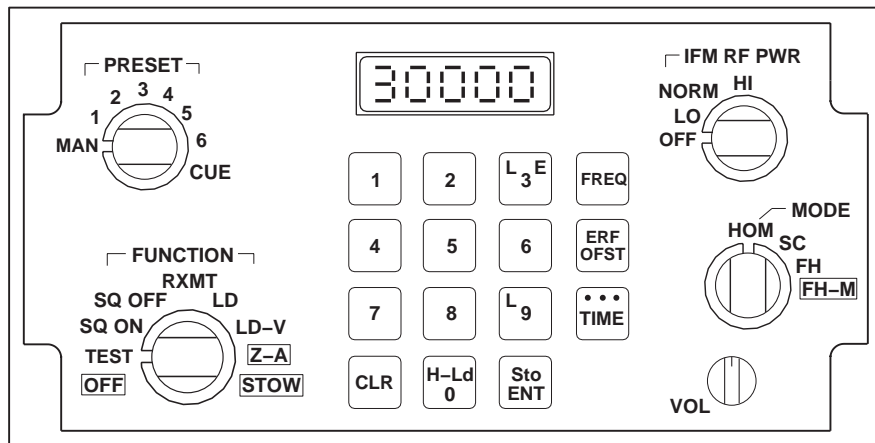

AA9243
SA

Figure 3-7. FM Control AN/ARC-201

CONTROL	FUNCTION	
FREQ	Display current operating frequency during single channel (manual or preset) operation.	b. Two-way voice, secure voice, when TSEC/KY-58 is installed. Refer to paragraph 3.11.
ERF/OFST	Modify single channel operating frequency, manually selected or preset, to include offsets of ± 5 KHz or ± 10 KHz.	c. Two-way voice, frequency hopping (FH or FH-M). Secure voice can be used at the same time if desired.
TIME	Used to display or change the time setting maintained within each RT.	d. Homing (HOM).
STO	Store or enter any frequency into RT; store a received HOPSET or LOCKOUT set held in holding memory.	e. Retransmission (Function - RXMT).
0/LOAD	Enter zeros; initiate transfer of ECCM parameters.	
CLR	Zeroize the display; clear erroneous entries.	

3.8.4 Starting Procedure. The radio is capable of operating in any of the modes indicated by the **MODE** selector switch (Figure 3-7) and retransmission on the **FUNCTION** switch.

3.8.4.1 Single Channel (SC) Mode.

1. **FUNCTION** - **SQ ON** or **SQ OFF**.
2. **MODE** - **SC**.
3. **PRESET** - **MAN**.
4. Push **FREQ** then **CLR** button. The display will show all bottom dashes.
5. Enter frequency - 5 digits.

- a. Two-way voice, normal (**SC**).

6. Push **STO** button. The display will flash once to acknowledge correctly entered frequency.
7. ICS transmitter selector - Position **1** (FM No. 1), or position **4** (FM No. 2).
8. Radio push-to-talk switch - Press to talk; release to listen.

3.8.4.2 Enter Frequency into PRESET.

1. **FUNCTION - LD.**
2. **PRESET** - Desired number **1** to **6**.
3. **MODE - SC.**
4. Push **FREQ** then **CLR** button. The display will show all bottom dashes.
5. Enter frequency - 5 digits.
6. Push **STO**. The display will flash once.
7. Repeat steps 1. through 6. for each desired pre-set channel.

3.8.4.3 Frequency Hopping (FH or FN-M) Mode.

1. **MODE - FH** or **FH-M.**
2. **PRESET** - Select net (1-6).
3. **FUNCTION - SQ ON** or **SQ OFF.**

3.8.4.4 Homing (HOM) Mode (FM No. 1 only).

1. Enter or select frequency - **MAN** or **PRESET.**
2. **MODE - HOM.**
3. **MODE SEL - FM HOME.**
4. **CIS MODE SEL - NAV.**
5. Observe homing indicators on vertical situation indicator (VSI) (Figure 3-30). These are:
 - a. FM navigation (**NAV**) flag will move from view, and will come into view if the received signal is too weak.
 - b. A steering (course indicator) pointer moves either left or right about 5° to indicate any

deviation from the course to the transmitting station.

- c. Station passage will be indicated by course deviation change and **CIS MODE SEL NAV** switch light going out and **HDG** switch light going on.

3.8.5 Retransmission (RXMT). Retransmission permits helicopter to be used as an airborne relay (Figure 3-12).

1. **FUNCTION - RXMT.**
2. Frequency(s) - Select.
3. **RADIO RETRANSMISSION** selector switch - Set to radios used.
4. Establish communications between each relay in helicopter and its counterpart radio at the terminal station by using appropriate ICS TRANS selector. If audio monitoring is desired, adjust **VOL** control for suitable output.

3.8.6 Stopping Procedure. FUNCTION - OFF.

3.9 RECEIVER-TRANSMITTER RADIO, RT-1167/ARC-164(V).

Receiver-Transmitter Radio, RT-1167/ARC-164(V) (Figure 3-8) is an airborne, ultra-high frequency (UHF), amplitude-modulated (AM), radio transmitting-receiving (transceiver) set. It contains a multichannel, electronically tunable main transmitter and receiver, and a fixed-tuned guard receiver. The main transceiver operates on any one of 7,000 channels, spaced in 0.025 MHz units in the 225.000 to 399.975 MHz UHF military band. The guard receiver is tunable in the 238.000 to 248.000 MHz frequency range with crystal replacement and realignment (usually 243.000 MHz). The radio set is primarily used for voice communications. An additional capability for retransmission allows use of the radio set as a relay link. The pilot can identify the basic HAVE QUICK radio by the **A** and **T** positions on the frequency selector switch. The HAVE QUICK II can be identified by the letters **EMB** (expanded memory board) on the face of the **UHF** controls (Figure 3-8). Power to operate the ARC-164(V) radio is from the dc essential bus, through a circuit breaker, marked **UHF-AM.**

3.9.1 Antenna. The UHF-AM antenna is under the fuselage transition section (Figure 3-1) or **EH** under the fuselage below the copilot's seat. The antenna pro-

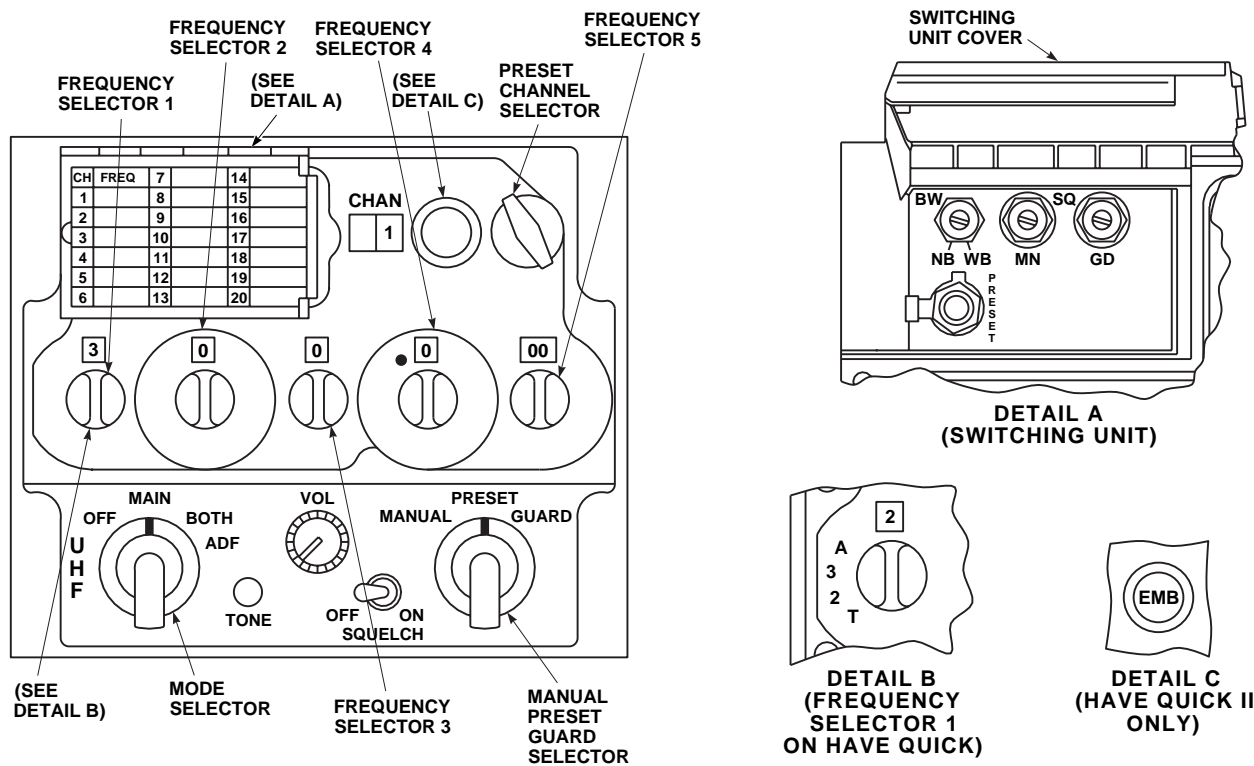



Figure 3-8. UHF Control, AN/ARC-164(V)

vides a path for both the radiated and received UHF comm signals. The EH-60 AN/ALQ-151(V) mission package has two UHF-AM radios that utilize the existing fuselage transition section conformal antenna for the voice link and adds the data link antenna under the fuselage where the cargo hook would normally be installed.

3.9.2 Tunable Diplexer.  The tunable diplexer (TD-1336/A) is connected between the antenna and the output of the ARC-164(V). When properly tuned, the diplexer acts as a bridge network isolating signals of similar frequency which share the same antenna. It allows the guard channel in the ARC-164(V) guard receiver to be monitored while other frequencies in the main transmitter-receiver are being used.

3.9.3 Controls and Functions. Controls for ARC-164(V) are on the front panel of the unit (Figure 3-8). The function of each control is as follows:

CONTROL	FUNCTION
Manual frequency selector switch 1	Selects 100's digit of frequency (either 2 or 3) in MHz.
Manual frequency selector switch 2	Selects 10's digit of frequency (0 through 9) in MHz.
Manual frequency selector switch 3	Selects units digit of frequency (0 through 9) in MHz.
Manual frequency selector switch 4	Selects tenths digit of frequency (0 through 9) in MHz.
Manual frequency selector switch 5	Selects hundredths and thousandths digits of frequency (00, .25, .50, or .75) in MHz.

AA1090B
SA

CONTROL	FUNCTION
Preset channel selector switch	Selects one of 20 preset channels.
MANUAL-PRESET-GUARD selector	Selects method of frequency selection:
MANUAL	Any one of 7,000 frequencies is manually selected using the five frequency selector switches.
PRESET	Frequency is selected using the preset channel selector switch for selecting any one of 20 preset channels as indicated on the CHAN indicator.
GUARD	The main receiver and transmitter are automatically tuned to the guard frequency and the guard receiver is disabled. Blocks out frequencies set either manually or preset.
SQUELCH ON-OFF switch	Turns squelch of main receiver on or off.
VOL control	Adjusts volume.
TONE switch	Enables transmission and headset monitoring of a 1,020-Hz tone on selected frequency for maintenance check only.
Mode selector switch	Selects operating mode function:
OFF	Turns power off.
MAIN	Enables main receiver and transmitter.
BOTH	Enables main receiver, transmitter, and guard receiver.
ADF	Enables UHF-DF group, main receiver, and guard receiver.
BW switch (NB-WB)	Selects wideband or narrow-band selectivity of main receiver.
SQ-MN control	Adjusts threshold level of squelch for main receiver.
SQ-GD control	Adjusts threshold level of squelch for guard receiver.

CONTROL	FUNCTION
PRESET switch	Stores selected frequency in selected preset channel.

3.9.3.1 Modes of Operation.

a. Depending on the settings of the operating controls, the radio set can be used for these modes of operation:

- (1) Two-way voice, normal.
- (2) When voice security system is installed, refer to paragraph 3.11.
- (3) Transmission of 1.020 Hz TONE signal.
- (4) Constant monitoring of guard channel without losing main receiver use.
- (5) Retransmit.

b. The radio set has three different methods of frequency selection as determined by the position of the **MANUAL-PRESET-GUARD** switch. An explanation of these three positions is given in paragraph 3.9.3.

c. To use the radio set for any particular mode of operation, do this:

- (1) Mode selector - **MAIN** or **BOTH**.
- (2) **MANUAL-PRESET-GUARD** Frequency Selector - **MANUAL**, **PRESET** or **GUARD**.

d. A procedure for presetting the 20 preset channel numbers to the desired frequencies is given in paragraph 3.9.3.5.

3.9.3.2 Operation. The radio set can operate in any of the three modes, **MAIN**, **BOTH**, and **GUARD**.

3.9.3.3 Transmit/Receive (MAIN) Mode.

1. Mode selector - **MAIN**.
2. **MANUAL-PRESET-GUARD** selector - **MANUAL**.
3. Megahertz controls - Desired frequency.
4. ICS transmitter selector - Position **2**.

5. Establish communication by keying transmitter and speaking into microphone. Release to listen and adjust audio output for a comfortable level.

3.9.3.4 Guard Channel Constant Monitoring. The guard channel monitoring (Figure 3-8) mode of operation is used when it is desired to monitor a frequency within the 238.000 to 248.000 MHz band, usually 243.000 MHz. Transmission on this frequency should be limited to emergency use only. When conditions require transmissions on the emergency frequency, the **MANUAL-PRESET-GUARD** selector switch must be at **GUARD**, or the main receiver must be tuned to the emergency frequency.

NOTE

If reception on the selected frequency is interfering with guard reception, detune the set by selecting an open frequency, or place the **MANUAL-PRESET-GUARD** switch to **GUARD**.

3.9.3.5 Preset Channel Selector Memory Storage.

Set 20 preset channel numbers to desired frequencies as follows (Figure 3-8):

1. Place **MANUAL-PRESET-GUARD** switch to **PRESET**.
2. Use manual frequency selector switches to select frequency to be placed in memory.
3. Turn preset channel selector switch to desired channel number.
4. Press and release **PRESET** switch.
5. Using a soft lead (erasable) pencil, record frequency selected for channel number used on card on front panel.

3.9.3.6 Retransmit. Retransmission permits the helicopter to be used as an airborne relay link. To operate as a relay unit, additional installed equipment must be used (Figure 3-12).

1. Frequency - Select.
2. **RADIO TRANSMISSION** selector switch -Set to radio sets to be used.
3. Establish communication between each relay radio in helicopter and its counterpart radio link terminal station by using appropriate ICS transmitter selector.

3.9.3.7 Guard (Emergency) Operation.

1. **MANUAL-PRESET-GUARD** switch to **GUARD**.
2. ICS transmitter selector - Position **2**.
3. Radio push-to-talk switch on cyclic stick or foot-operated push-to-talk switch - Press to talk.

3.9.4 Stopping Procedure. Mode Selector - **OFF**.

3.10 RECEIVER-TRANSMITTER RADIO, RT-1167C/ARC-164(V).

Receiver-Transmitter Radio RT-1167C/ARC-164(V) (Figure 3-8) has the same functions, capabilities and modes of operation as the RT-1167/ARC-164(V) plus a **HAVE QUICK** mode of operation. **HAVE QUICK** is an anti-jamming mode which uses a frequency hopping scheme to change channels many times per second. Because the **HQ** mode depends on a precise time-of-day, both **HQ** radios must have synchronized clocks.

3.10.1 HAVE QUICK (HQ) System.

a. The **HQ** system provides a jam resistant capability through a frequency hopping technique. Frequency hopping is a technique in which the frequency being used for a given channel is automatically changed at some rate common to the transmitter and receiver. The jam resistance of the system is due to the automatic frequency changing and the pseudorandom pattern of frequencies used. In order to defeat this communications system, the jammer must find the frequency being used, jam it and then predict or find the next frequency. The **HAVE QUICK** modification adds the frequency hopping capability, yet it does not remove any of the previous capabilities of the radio. The **HQ** modified radios retain the standard, single frequency **UHF** voice mode of operations. This is referred to as the normal mode, while frequency hopping operation is called the anti-jam (**AJ**) mode. Several ingredients are necessary for successful system operations. These are:

- (1) Common frequency.
- (2) Time synchronization.
- (3) Common hopping pattern and rate.
- (4) Common net number.

b. The common frequencies have been programmed into all **HQ** radios. Time synchronization is provided via **UHF**

radio and/or hardware by external time distribution system. A time-of-day (TOD) signal must be received from the time distribution system for each time the radio is turned on. The hopping pattern and hopping rate are determined by the operator inserted word-of-day (WOD). The WOD is a multi-digit code, common worldwide to all HAVE QUICK users. In the AJ mode, a communications channel is defined by a net number instead of a signal frequency as in the normal mode. Before operating in the AJ mode, the radio must be primed. This consists of setting the WOD, TOD, and net number. The AJ mode is then selected by placing the frequency selector 1 switch to **A**.

3.10.1.1 Frequency Selector 1 Switch (HQ Only).

- a. **A**- Selects AJ mode (Figure 3-8).
- b. **3**- Allows manual selection of frequencies.
- c. **2**- Allows manual selection of frequencies
- d. **T**- Momentary position which enables the radio to accept a new TOD for up to 60 seconds after selection. Also used in conjunction with the emergency startup of the TOD clock when TOD is not available from an external source.

3.10.1.2 TONE Button (HQ Only). Depressing the **TONE** button in normal or AJ modes interrupts reception and transmits a tone signal and TOD on the selected frequency. Simultaneously pressing the **TONE** button in conjunction with the frequency selector 1 switch in the **T** position starts the emergency startup of the TOD clock.

3.10.1.3 Word Of Day (WOD). The WOD entry is normally entered before flight, but it is possible to enter it in flight. WOD is entered by using one or more of the six preset channels which are 15-20. For a new WOD entry, start at channel 15 and use the same method as in entering preset frequencies in the normal mode with the frequency knobs and the **PRESET** button. After each entry, a single beep is heard until channel 20 entry; a double beep is heard indicating that the radio has accepted all six WOD entries.

3.10.1.4 WOD Transfer. Select the preset mode and, starting with preset channel 15, rotate the preset knob counter clockwise. At channel 15, a single beep is heard. A single beep indicates that channel 15 data has been transferred and accepted. After the single beep is heard, select remaining channels (16-20) in the same manner until a double beep is heard indicating the WOD transfer is complete.

3.10.1.5 Time Of Day (TOD) Transmission. The TOD entry is normally entered before flight, but it is pos-

sible to enter it in flight. It is possible to transmit timing information in both normal and AJ modes by momentarily pressing the **TONE** button. In the normal mode, a complete TOD message is transmitted, while in the AJ mode, only an abbreviated time update is transmitted. A mode time transmission allows a time update if one radio has drifted out of synchronization.

3.10.1.6 Time Of Day Reception. Reception is possible in both normal and AJ modes. The radio automatically accepts the first TOD message after the radio is turned on and WOD transferred. Subsequent messages are ignored unless the **T** position is selected with the frequency selector 1 switch. The radio then accepts the next TOD update in either normal or AJ mode, provided the TOD update arrives within 60 seconds of the time the **T** position has been selected. To receive time in the normal mode, rotate the frequency selector 1 switch to the **T** position and return to a normal channel in either the manual or preset mode. To receive a time update in AJ mode, rotate the frequency selector 1 switch to the **T** position and then back to the **A** position. A TOD update (time tick) can be received on the selected AJ net.

3.10.1.7 Net Numbers. After WOD and TOD are entered, any valid AJ net number can be selected by using the manual frequency knob.

3.10.1.8 Anti-Jamming Mode Operation. A tone is heard in the headset if an invalid AJ net is selected, if TOD was not initially received, or if WOD was not entered. If the function knob is set to both and the AJ mode is selected, any transmission on the guard channel takes precedence over the AJ mode.

3.10.2 Operational Procedures Radio Set AN/ARC-164(V).

1. Transfer WOD IAW "WOD TRANSFER" paragraph 3.10.1.3.
2. Setup RT to receive TOD.
 - a. With external TOD equipment.
 - (1) Select manual mode on MODE switch.
 - (2) Set TOD frequency in manual frequency windows.
 - (3) Set frequency selector 1 switch to **A**, after TOD beep is heard. If tone is heard with the frequency selector 1 switch in the **A** position, reinitialize

radio IAW steps in "TOD TRANSMISSION" paragraph 3.10.1.5.

b. Without external TOD equipment: Emergency start-up of TOD clock.

- (1) Set and hold frequency selector 1 switch to **T**.
- (2) Press the **TONE** button.

NOTE

When using this method, the flight commander or lead aircraft should emergency start his TOD clock. Lead aircraft would then transfer TOD to other aircraft in flight. Aircraft using this method will not be able to communicate with valid TOD signal in the AJ mode. A valid TOD signal must be transferred to all aircraft that have invalid TOD time before effective AJ communications can be achieved.

3.10.2.1 HQ Checklist ARC-164, Loading Word-of-Day (WOD).

1. Frequency selector 1 switch - Not in **A** position.
2. Mode selector switch - **BOTH**.
3. **MANUAL-PRESET-GUARD** switch - **PRESET**.
4. Manual frequency display - Set WOD 15.
5. Preset channel select - Set to 15.
6. **PRESET** button (under frequency cover) - Press.
7. Manual frequency display - Set WOD 16.
8. Preset channel select - Set to 16.
9. **PRESET** button - Press.
10. Repeat steps 7 thru 9 to store WOD 17, 19.
11. Manual frequency display - Set 300.050.
12. Preset channel select - Set to 20.
13. **PRESET** button - Press.

14. Rotate preset select down 19, 18, 17, 16, 15, (hear 1 beep 20-16, 2 beeps on 15).

3.10.2.2 Receiving Time from Net Control Aircraft.

1. **MANUAL-PRESET-GUARD** switch - **MANUAL**.
2. Set to internal frequency to receive the time.
3. Hear net control aircraft state: "Standby for time".
4. Rotate frequency selector 1 switch to **T** and return to established manual frequency, hear.
5. Hear net control aircraft state: "Go active 0 point one."
6. Set A00.100 in manual window and complete commo check; if loud tone is heard, repeat timing.

3.10.2.3 Sending Time (Net Control Aircraft).

1. **MANUAL-PRESET-GUARD** switch - **MANUAL**.
2. Set to internal frequency.
3. Rotate frequency selector 1 switch to **T** and hold.
4. Press tone button and hold (hear no tone).
5. Frequency selector 1 switch to internal frequency (0.25 second beep, then tone).
6. Call other aircraft to send time.
7. Press tone button to send time.

NOTE

Recall today's WOD by reselecting presets 20 down thru 15, and hear beeps.

3.11 VOICE SECURITY SYSTEM.

3.11.1 TESC/KY-28. Three TSEC/KY-28s (Figure 3-9) are used as auxiliary equipment to provide voice security (ciphony) mode. Control indicator C-8157/ARC is used by the pilot and copilot to control TSEC/KY-28 for FM-1, FM-2 and UHF-AM. The control has four switches and

three indicator lamps. Power to operate the TSEC/KY-28 for the No. 1 and No. 2 AN/ARC-114A systems is provided from the dc essential bus through a circuit breaker, marked **COMM SCTY SET NO. 1 FM**, and No. 1 dc primary bus through a circuit breaker, marked **NO. 2 FM COMM SCTY SET** respectively. Power to operate the AN/ARC-164(V) TSEC/KY-28 is provided from the dc essential bus through a circuit breaker, marked **COMM SCTY SET UHF AM**. Each Control C-8157/ARC is located adjacent to the radio set it supports. Two operating modes are available when the TSEC/KY-28 is installed in the helicopter; **PLAIN** mode for clear voice radio transmission or reception, and **CIPHER** mode for secure voice radio transmission or reception.

NOTE

When the TSEC/KY-28s are installed in the helicopter, the TSEC/KY-28 for the intended use radio set must be ON before radio communication, plain or ciphered, is possible. Non-secure radios will not be keyed when using any secure radio or the intercom for classified communications.

3.11.1.1 Controls and Functions. Controls for the TSEC/KY-28 are on the front panel of the C-8157/ARC (Figure 3-9). The function of each control is as follows:

CONTROL	FUNCTION
POWER ON	Turns set on and off. Switch must be on (up) for operation in either plain or cipher mode.
POWER ON light (amber)	Lights when POWER ON switch is placed on (up).
PLAIN-CIPHER switch	At PLAIN , permits normal communications on associated equipment. At CIPHER , permits secure voice communications on associated equipment.
Plain mode indicator light (red)	Lights when PLAIN-CIPHER switch is at PLAIN .
Cipher mode indicator light (green)	Lights when PLAIN-CIPHER switch is at CIPHER .
RE-X, REG switch	RE-X , Not used in this installation. At REG , permits normal or secure communications.

CONTROL

FUNCTION

ZEROIZE switch (two-position locking toggle, under spring-loaded cover). Normally in off (down) position. Placed in on (up) position during emergency situations to zero any code setting and make associated TSEC/KY-28 equipment unusable.

NOTE

Do not place **ZEROIZE** switch on (up) unless a crash or capture is imminent.

3.11.1.2 Operation.

- a. Preliminary operation.
 - (1) **CIPHONY POWER** switch - **ON**.
 - (2) Apply power to associated transmitter/ receiver.
 - (3) When power is initially applied, this automatic alarm procedure is initiated.
 - (a) A constant tone is heard in headset, and after about 2 seconds, this tone will change to an interrupted tone.
 - (b) To clear interrupted tone, press and release push-to-talk switch. Interrupted tone will no longer be heard, and circuit will be in a standby condition ready for either transmission or reception. No radio communications will be passed if interrupted tone is still heard after pressing and releasing push-to-talk switch.
 - (4) **RE-X, REG** switch - Set for **REG**.
- b. Plain Mode.
 - (1) **CIPHONY POWER** switch - **ON**.
 - (2) **PLAIN-CIPHER** switch - **PLAIN**, **PLAIN** mode indicator light (red) should be on.
 - (3) **RE-X, REG** switch - **REG**.

- (4) ICS transmitter selector - Select desired position.
- (5) Radio push-to-talk switch on cyclic stick or foot-operated push-to-talk - Press to talk; release to listen.

c. Cipher Mode.

- (1) **CIPHONY POWER** switch - **ON**.
- (2) **PLAIN-CIPHER** switch - **CIPHER**. Cipher mode light (green) should be on.
- (3) **RE-X, REG** switch - **REG**.
- (4) ICS transmitter selector - Select desired position.
- (5) To transmit, press radio press-to-talk switch. **DO NOT TALK**. A short beep will be heard. This indicates receiving station is now capable of receiving your message. Begin transmitting.

NOTE

Only one TSEC/KY-28 can be used on a given frequency at any one time. Always listen before attempting transmission to make certain that no one else is transmitting.

- (6) When transmission is completed, release press-to-talk switch. This will return equipment to standby.
- (7) To receive, it is necessary for another station to send you a signal first. Upon receipt of a signal, the cipher equipment will be switched automatically to the receive condition which will be indicated by a short "beep" heard in the headset. Reception will then be possible. Upon loss of the signal, the cipher equipment will be automatically returned to standby.

3.11.1.3 Stopping Procedure. CIPHER-PLAIN switch - **PLAIN**.

3.11.2 TSEC/KY-58.

a. Description. A complete description of the TSEC/KY-58 can be found in TM 11-5810-262-10. This voice

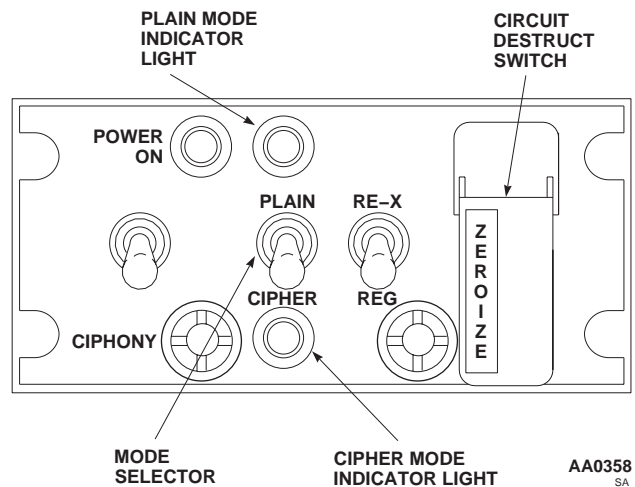

Figure 3-9. Voice Security System Control C-8157/ARC

security equipment is used with the FM1, FM2 and UHF-AM radio to provide secure two-way communication. The equipment is controlled by the Remote Control Unit (RCU) (Z-AHP) mounted in the lower console. The **POWER** switch must be in the **ON** position, regardless of the mode of operation, whenever the equipment is installed.

b. Controls and functions. Figure 3-10.

c. Operating procedures.

NOTE

To talk in secure voice, the KY-58 must be "loaded" with any number of desired variables.

- (1) Secure voice procedures.
 - (a) **MODE** switch - **OP**.
 - (b) **FILL** switch - Set to the storage register which contains the crypto-net variable (CNV) you desire.
 - (c) **POWER** switch - **ON**.
 - (d) **PLAIN, C/RAD** switch - **C/RAD1**.
 - (e) **DELAY** switch - Down unless the signal is to be retransmitted.

NOTE

At this time a crypto alarm, and background noise, in the aircraft audio intercom system should be heard.

To clear alarm:

- (f) PTT (push-to-transmit) switch - Press and release.

NOTE

When operating in either secure or clear (plain) voice operations the volume must be adjusted on the aircraft radio and intercom equipment to a comfortable operating level.

(2) Clear voice procedures:

- (a) **POWER** switch - **ON**.
- (b) **PLAIN, C/RAD** switch - **PLAIN**.

NOTE

Instructions should originate from the Net Controller or Commander as to when to zeroize the equipment.

(3) Zeroing procedures.

- (a) **POWER** switch - **ON**.
- (b) Spring-loaded **ZEROIZE** switch - Activate and release. This will zeroize all positions (1-6). The equipment is now zeroized and secure voice communications are no longer possible.

(4) Automatic remote keying procedures.

NOTE

Automatic remote keying (AK) causes an "old" crypto-net variable (CNV) to be replaced by a "new" CNV. Net controller simply transmits the "new" CNV to your KY-58.

- (a) The net controller will use a secure voice channel, with directions to stand by for an AK transmission. Calls should not be made during this standby action.

(b) Several beeps should now be heard in your headset. This means that the "old" CNV is being replaced by a "new" CNV.

(c) Using this "new" CNV, the net controller will ask you for a "radio check."

(d) After the "radio check" is completed, the net controller instructions will be to resume normal communications. No action should be taken until the net controller requests a "radio check."

(5) Manual remote keying procedures.

(a) The net controller will make contact on a secure voice channel with instructions to stand by for a new crypto-net variable (CNV) by a manual remote keying (MK) action. Upon instructions from the net controller:

1 Set the Z-AHP **FILL** switch to position 6. Notify the net controller by radio, and stand by.

2 When notified by the net controller, set the Z-AHP **MODE** switch to RV (receive variable). Notify the net controller, and stand by.

3 When notified by the net controller, set the Z-AHP **FILL** switch to any storage position selected to receive the new CNV (May be unused or may contain the variable being replaced). Notify the net controller, and stand by.

NOTE

When performing Step 3, the storage position (1 through 6) selected to receive the new CNV may be unused, or it may contain the variable which is being replaced.

(b) Upon instructions from the net controller:

1 Listen for a beep on your headset.

2 Wait two seconds

3 Set the RCU **MODE** switch to **OP**

4 Confirm

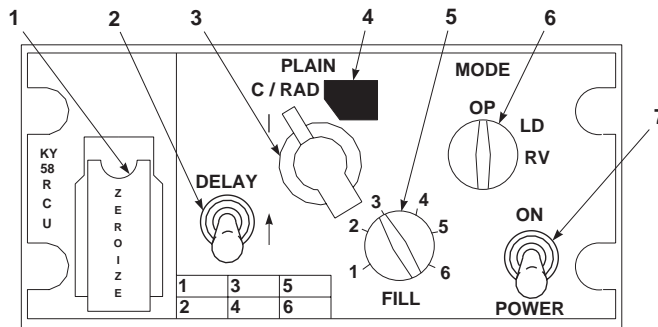

REMOTE CONTROL UNIT (RCU) (Z-AHP)

CONTROL	FUNCTION
1. ZEROIZE SWITCH TWO-POSITION MOMENTARY TOGGLE UNDER SPRING LOADED COVER	ZEROIZES THE KY-58; CLEARS ALL ENCODING IN THE SYSTEM.
2. DELAY SWITCH TWO-POSITION TOGGLE	UP WHEN SIGNAL IS TO BE RETRANSMITTED.
3. PLAIN-C / RAD SWITCH ROTARY TWO-POSITION SELECTOR SWITCH	IN THE PLAIN POSITION, PERMITS NORMAL (UNCIIPHERED) COMMUNICATIONS ON THE ASSOCIATED FM RADIO SET. IN THE C / RAD POSITION, PERMITS CIPHERED COMMUNICATIONS ON THE ASSOCIATED RADIO SET.
4. C / RAD2 SWITCH STOP	LOCATION STOP FOR C / RAD2 ON FRONT PANEL.
5. FILL SWITCH SIX POSITION ROTARY SWITCH	PERMITS PILOT TO SELECT ONE OF 6 STORAGE REGISTERS FOR FILLING.
6. MODE SWITCH THREE POSITION ROTARY	IN THE OP POSITION KY-58 NORMAL OPERATING, IN THE LD POSITION FOR FILLING. IN THE RV POSITION KY-58 IN RECEIVE-VARIABLE, FILLED FROM ANOTHER EXTERNAL SOURCE.
7. POWER ON SWITCH TWO POSITION TOGGLE	CONNECTS POWER TO THE ASSOCIATED TSEC / KY-58 CIPHER EQUIPMENT IN THE ON (FORWARD) POSITION, AND DISCONNECTS POWER FROM THE EQUIPMENT IN THE OFF (AFT) POSITION. TURNS ON POWER TO TSEC / KY-58.

AA0524
SA

Figure 3-10. Voice Security Equipment

- (c) If the MK operation was successful, the net controller will now contact you via the new CNV.
- (d) If the MK operation was not successful, the net controller will contact you via clear voice (plain) transmission; with instructions to set your Z-AHP **FILL** selector switch to position 6, and stand by while the MK operation is repeated.
- (6) It is important to be familiar with certain KY-58 audio tones. Some tones indicate normal operation, while other indicate equipment malfunction. These tones are:
 - (a) Continuous beeping, with background noise, is cryptoalarm. This occurs when power is first applied to the KY-58, or when the KY-58 is zeroized. This beeping is part of normal KY-58 operation. To clear this tone, press and release the PTT button on the Z-AHQ (after the Z-AHQ LOCAL switch has been pressed). Also the PTT can be pressed in the cockpit.
 - (b) Background noise indicates that the KY-58 is working properly. This noise should occur at TURN ON of the KY-58, and also when the KY-58 is generating a cryptovarialbe. If the background noise is not heard

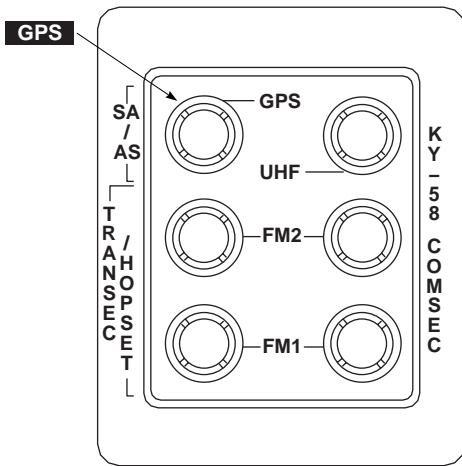

AA9244A
SA

Figure 3-11. Remote Fill Panel

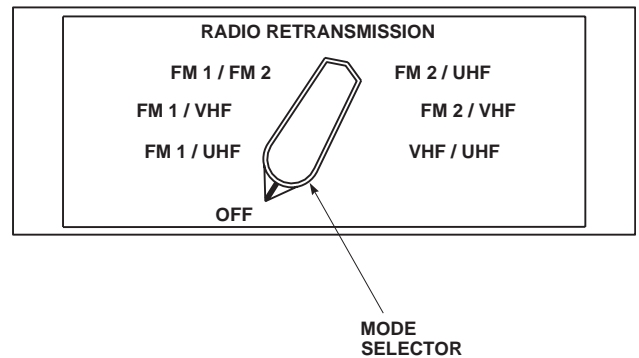

AA0359
SA

Figure 3-12. Retransmission Control Panel

at TURN ON, the equipment must be checked out by maintenance personnel.

- (c) Continuous tone, could indicate a "parity alarm." This will occur whenever an empty storage register is selected while holding the PTT button in. This tone can mean any of three conditions:

- 1 Selection of any empty storage register.
- 2 A "bad" cryptovariable is present.
- 3 Equipment failure has occurred. To clear this tone, follow the "Loading Procedures" in TM 11-5810-262-10. If this tone continues, have the equipment checked out by maintenance personnel.

- (d) Continuous tone could also indicate a cryptoterror. If this tone occurs at any time other than in (c) above, equipment failure may have occurred. To clear this tone, repeat the "Loading Procedures" in TM 11-5810-262-10. If this tone continues, have the equipment checked out by maintenance personnel.

- (e) Single beep, when RCU is not in TD (Time Delay), can indicate any of the three normal conditions:

- 1 Each time the PTT button is pressed when the KY-58 is in C (cipher) and a

filled storage register is selected, this tone will be heard. Normal use (speaking) of the KY-58 is possible.

- 2 When the KY-58 has successfully received a cryptovariable, this tone indicates that a "good" cryptovariable is present in the selected register.

- 3 When you begin to receive a ciphered message this tone indicates that the cryptovariable has passed the "parity" check, and that it is a good variable.

- (f) A single beep, when the RCU is in TD (Time Delay) occurring after the "preamble" is sent, indicates that you may begin speaking.

- (g) A single beep, followed by a burst of noise after which exists a seemingly "dead" condition indicates that your receiver is on a different variable than the distant transmitter. If this tone occurs when in cipher text mode: Turn RCU **FILL** switch to the CNV and contact the transmitter in PLAIN text and agree to meet on a particular variable.

3.11.2.1 KY-58 Remote Fill. A remote fill panel (Figure 3-11) allows a single crew member to load COMSEC variables into each of the three KY-58's from the pilots side lower center console, FM-1 and FM-2 AN/ARC-201 TRANSSEC and HOPSET codes can be loaded from the same panel.

3.12 RADIO RETRANSMISSION CONTROL.

Control of retransmission is through a switch panel (Figure 3-12) on the lower console. The position of the switch determines which radio set pairs will be used when the corresponding FM and VHF radio function and **VOL** switches (not required for UHF) are placed to **RETRAN**. Operation of the retransmission control is included with the operating procedures of each radio set where applicable. The retransmission control is only a means of directing the audio output of a receiver to the audio input of a transmitter through switching.

3.12A HF RADIO SET AN/ARC-220.



Make sure that no personnel are within 3 feet of the HF antenna when transmitting, performing radio checks or when in ALE mode. Do not touch the RF output terminal on the antenna coupler, the insulated feed through, or the antenna itself while the microphone is keyed (after the tuning cycle is complete) or while the system is in transmit self-test. Serious RF burns can result from direct contact with the above criteria.

a. The AN/ARC-220 HF transceiver provides long range communications. The HF radio receives and transmits on any one of 280,000 frequencies spaced at 100 Hz steps on the high frequency (HF) band. The HF radio has a frequency range of 2.0000 - 29.9999 MHz. Preset nets can be manually programmed by the pilot, or loaded with a data transfer device (DTD). Emission modes available are upper side band (USB) voice, lower side band (LSB) voice, amplitude modulation equivalent (AME), or continuous wave (CW), with a selection of 10, 50, or 175 watts of transmitting power. Transmit tune time is normally less than 1 second. The radio also has automatic link establishment (ALE) and electronic counter countermeasures (ECCM) frequency hopping mode. Data messages may be composed and stored in the receiver/transmitter's memory. These messages may be transmitted and received using any operational mode of the radio set.

b. Power for the radio is provided from the No. 1 dc primary bus through a circuit breaker marked **HF**.

3.12A.1 Antenna. The tubular antenna element extends from the left side of the transition area to a point just forward of the hinged tailcone section, and is supported by four masts. RF energy is supplied to the antenna through the forward mast (Figure 3-1).

3.12A.2 Controls and Functions. The radio is controlled by a control display unit (CDU) located in the lower console (Figure 3-12.1). The function of each control and display is as follows:

CONTROL/ DISPLAY	FUNCTION
CURSOR keys.	Position the cursor in the direction of the arrow on the key.
Display screen	Used to display system information, and enter data or commands in radio.
Line select keys	Function depends on adjacent display.
Brightness keys	Changes display screen brightness.
Net selector switch	Selects programmed operating net. The + position allows additional nets to be selected using the VALUE keys.
DATA connector	Fills radio with preprogrammed data, required for all modes except MAN .
KEY connector	Used to load ALE and ECCM presets.
Mode switch	
MAN	Operating frequency and emission mode is selected manually. Once selected, the information is stored in memory, and can be recalled using the net selector switch.
PRE	Selects a preprogrammed frequency and emission mode.
ALE	Selects Automatic link establishment (ALE) mode.
ECCM	Selects electronic counter countermeasure (ECCM) mode.

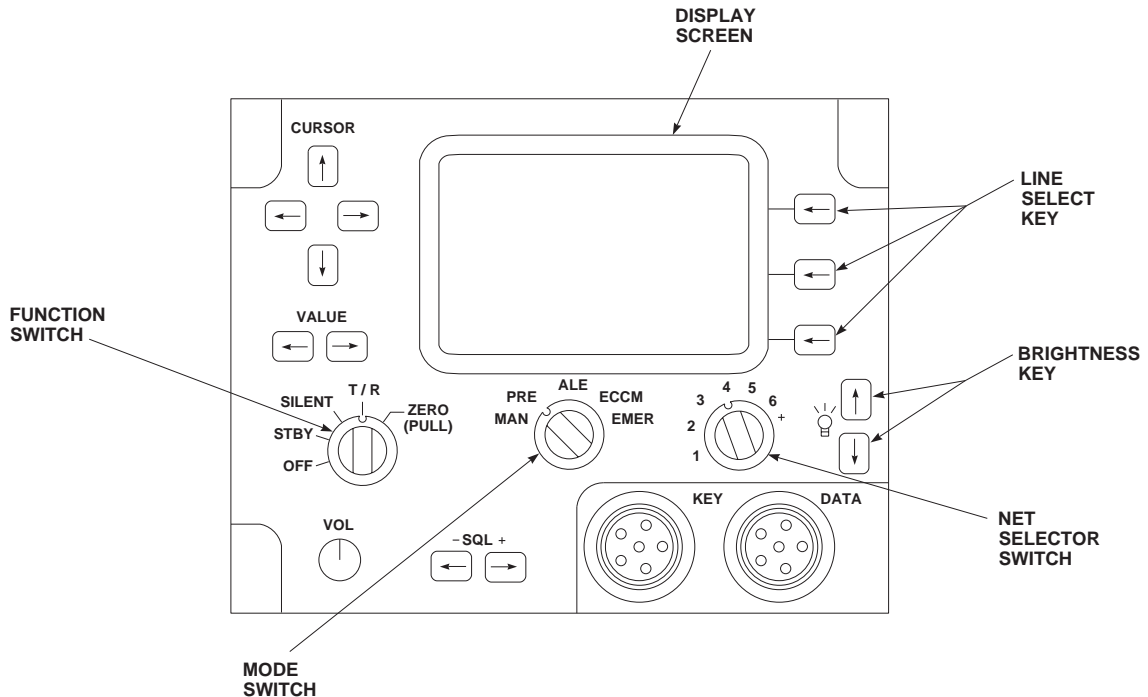

AB0988
SA

Figure 3-12.1. Control Display Unit AN/ARC-220

**CONTROL/
DISPLAY**

FUNCTION

**CONTROL/
DISPLAY**

FUNCTION

EMER Selects emergency mode.

-SQL+ keys Selects level of squelch from **TONE** through **5**. **TONE** provides no muting or squelch. **0** gives muting, but no squelch. **1** through **5** gives levels of muting and squelch. Muting turns off the scanning receiver audio and gives the pilot a tone when a **ALE** link is established.

VOL switch Changes receive audio output level. **VOL** settings are displayed for 5 seconds when radio is first powered up, or when the **VOL** setting is changed.

OFF Turns the radio off.

STBY Turns the radio on, performs bit and enables fill operations.

SILENT Prevents the radio from automatically responding to incoming calls in **ALE** or **ECCM** mode. Used during refueling, ordinance loading and **EMCON** conditions.

T/R Allows the radio to transmit and receive in selected operating mode.

ZERO Erases all loaded data, to include datafill and keyfill information.

VALUE keys Increases or decreases a field value or single character value that is marked by the cursor.

Function switch

**CONTROL/
DISPLAY**

FUNCTION

NOTE

Screen displays Each line can display up to 20 alphanumeric characters. The 5 characters closest to the line select keys are used for control selection. See Table 3-1.1 for advisory messages and their function.

If the radio breaks in and out of squelch, increase setting as required.

- e. **-SQL+** switch - Set squelch to **1**.
- f. Select the desired net (1 through 20), net selector switch - **1** through +. Use **VALUE** keys to select 7 through 20.
- g. ICS Transmitter selector - Position **5**.
- h. Radio push-to-talk switch - Press to talk; release to listen.

3.12A.3 Modes of Operation.

3.12A.3.1 Manual (MAN) Mode. Use manual mode to change transmit and receive frequencies, sidebands and transmit power, and operate the radio manually.

1. To change radio settings:
 - a. Mode switch - **MAN**.
 - b. Function switch - **T/R**.
 - c. Select the desired net (1 through 20), net selector switch - **1** through +. Use **VALUE** keys to select 7 through 20.
 - d. **EDIT** line select key - Press.

3.12A.3.2 Preset (PRE) Mode. Preset mode stores pre-programmed frequencies and emission modes that cannot be changed by the operator. To use the radio in preset mode, do the following:

1. Function switch - **T/R**.
2. Mode switch - **PRE**.
3. **-SQL+** switch - Set squelch to **0**.
4. **VOL** switch - Adjust for comfortable listening level.

NOTE

Changing the receive frequency and mode will also change the transmission frequency and mode to the same values. Changing the transmission frequency and mode will not change the receive frequency and mode.

- e. Edit frequency, emission mode and transmit power by placing the cursor under field to be edited with **CURSOR** key, and change field value with **VALUE** keys.
 - f. To end edit and store changed data, **RTN** line select key - Press.
2. To operate in manual mode:
 - a. Function switch - **T/R**.
 - b. Mode switch - **MAN**.
 - c. **-SQL+** switch - Set squelch to **0**.
 - d. **VOL** switch - Adjust for comfortable listening level.

NOTE

If the radio breaks in and out of squelch, increase setting as required.

5. **-SQL+** switch - Set squelch to **1**.
6. Select the desired net (1 through 20), net selector switch - **1** through +. Use **VALUE** keys to select 7 through 20.
7. ICS Transmitter selector - Position **5**.

NOTE

If tune tone is heard, wait until it stops before talking. When radio push-to-talk switch is pressed, **XMT** frequency is displayed. Display returns to preset display when switch is released.

8. Radio push-to-talk switch - Press to talk; release to listen.

3.12A.3.3 Automatic Link Establishment (ALE) Mode.

WARNING

When in ALE mode, the radio transmits interrogating signals (sounds) and replies to ALE calls automatically without operator action. To avoid personnel injury, ensure the function switch is not set to ALE when personnel are working near the helicopter, during refueling or loading ordinance.

NOTE

Self address must be selected before using ALE.

ALE mode may be used for communications, either normal or link protected, or position reporting.

1. To set up the radio for ALE communications, do the following:
 - a. Function switch - **T/R**.
 - b. Mode switch - **ALE**.
 - c. Select the desired net (1 through 20), net selector switch - **1** through **+**. Use **VALUE** keys to select 7 through 20.
 - d. **-SQL+** switch - Set squelch to **TONE**.
 - e. **VOL** switch - Adjust for comfortable listening level.

NOTE

Earphone audio is muted until a link is established. If the link is noisy, set squelch to **1**. Higher squelch settings are not recommended in this mode.

- f. **-SQL+** switch - Set squelch to **0**.
- g. To synchronize time in a link protected channel, **EDIT** and **SYNC** soft keys - Press.
- h. To broadcast AN/ARC-220 system time as net control, **EDIT**, then **TXTIM** soft keys

- Press. Time will be transmitted, and radio will return to scan mode.

2. To receive a ALE call:

- a. **INCOMING CALL** is displayed, followed by the caller's ALE address. A short tone sounds, and **LINKED** is displayed.
- b. ICS Transmitter selector - Position **5**.

NOTE

Wait for the calling station to make the first transmission.

- c. Radio push-to-talk switch - Press to talk; release to listen.
3. To place a ALE call:
 - a. Select ALE address:

- (1) Select the desired net (1 through 20), net selector switch - **1** through **+**. To select 7 through 20, set the selector switch to the **+** position and use the value keys to scroll to the desired selection. Net name and address will be displayed.
- (2) **VALUE** switch - Press, to scroll through address list.
- (3) If placing an ALE call to an address not in the list, edit the address as follows: **EDIT** soft key - Press. Enter address one character at a time with **CURSOR** and **VALUE** switches. To accept the edit and return to ALE screen, **RTN** soft key - Press.

- b. ICS Transmitter selector - Position **5**.

NOTE

Press **ABORT** to stop the calling process.

- c. Radio push-to-talk switch - Press (and release). **CALLING**, then **LINKED** is displayed with a short gong tone in head-phone.

NOTE

ALE will cancel the link, and return to scan mode if there is no activity on a link for a predetermined time as set by the data fill (60 seconds is a typical value). To maintain a link, press **HOLD** soft key. When communications are complete, or to return to scan mode, press **SCAN** soft key.

- d. Radio push-to-talk switch - Press to talk; release to listen.
- e. When communication is complete, to return to scanning mode, **HOLD**, then **SCAN** soft key - Press.

3.12A.3.4 Electronic Counter Countermeasures (ECCM) Mode.

The radio changes frequency in a sequence determined by the ECCM key. Datafill and keyfill must be loaded prior to using ECCM mode, and system time must be synchronized between stations. Frequencies used in hop sets are pretuned in the radio, as ECCM requires frequencies to be changed many times per second. Frequency hopping is performed in the ECCM mode of operation. To use this mode, do the following:

- 1. Initialize the net:
 - a. Function switch - **T/R**.
 - b. Mode switch - **ECCM**.
 - c. Select the desired net (1 through 12), net selector switch - **1** through **+**. Use **VALUE** keys to select 7 through 12.
 - d. To change values on screen, **EDIT** soft key - Press. Use **CURSOR** to position cursor

under area to change, and **VALUE** to change the field to desired value.

- e. To save changes and return to top level screen, **RTN** soft key - Press.
- f. Push-to-talk switch - Press, to tune and time synchronize the radio.

2. To communicate in ECCM only mode, do the following:

- a. **-SQL+** switch - Set squelch to **TONE**.
- b. **VOL** switch - Adjust for comfortable listening level.

NOTE

If the frequency is noisy, set squelch to **1**. Higher squelch settings are not recommended in this mode.

- c. **-SQL+** switch - Set squelch to **0**.
- d. Press and hold the push-to-talk switch until **XMT READY** is displayed. Wait for pre-amble tones to stop.
- e. Talk. Release switch to listen.

3. Deleted.

3.12A.3.5 Message Mode. The radio can store up to 10 transmit data and 10 received data messages. Each message may be

500 characters long. Messages are numbered from 1 to 10. Message 10 is the oldest, and will be deleted if a new message is received. Messages may be composed using the AN/ARC-220 CDU dictionary or with a custom dictionary listing locally generated words, which may be loaded with datafill.

1. To view a received message:

- a. **MSG** soft key - Press.
- b. Use **CURSOR** keys to scroll left or right, or up and down in a message.
- c. Use **VALUE** keys to page up and down in a message.
- d. To view additional messages, position cursor under message number with **CURSOR** keys. Use **VALUE** keys to scroll to the next message number.
- e. To retain received messages, **RTN** soft key - Press.
- f. To delete received messages, position the cursor under the message number and **DEL** soft key - Press, until messages are deleted. To return to top screen, **RTN** soft key - Press.

2. To edit or compose a message:

- a. **MSG** soft key - Press.
- b. From **MESSAGE** screen, **PGRM** soft key - Press.
- c. Select message to be edited by placing cursor under the message number with **CURSOR** keys, and change number with **VALUE** keys.
- d. Edit message by placing cursor under area to be changed. Use **VALUE** keys to change one character at a time. Press **DEL** to delete one character at a time.
- e. To insert a word from the dictionary in a message do the following:

- (1) Position cursor where the word is to be inserted

- (2) **WORD** soft key - Press.

- (3) Select the word with **VALUE** keys.

- (4) To insert word with blank in message, **SELECT** soft key - Press. If desired, return to message without inserting a word by pressing **CANCL**.

- f. To load edited message in R/T memory and return to top level screen, **RTN** soft key - Press.

3. To send a message:

- a. Access **PRGM MSG** screen by pressing **MSG**, then **PRGM** soft keys.
- b. Select message to send as desired by placing cursor under message number, and pressing **VALUE** keys until desired message is displayed.

NOTE

Message will be sent to currently selected address (ALE modes) or transmitted on the currently selected frequency and mode (MAN, PRE, or ECCM).

- c. **SEND** soft key - Press.

3.12A.4 Operation.

3.12A.4.1 Starting Procedure.

1. Function switch - **STBY**. **SYSTEM TESTING** is displayed while power up built in test (PBIT) is in process. **SYSTEM - GO** will be displayed upon successful completion of PBIT.
2. **FILL** line select key - Press. Status of **PRE**, **ALE**, **ECCM**, and **EMER** modes will be displayed.

3.12A.4.2 Load Presets. Datafill contains preset frequencies, scan lists, addresses, data messages, and non secure information needed for ALE/ECCM operation. If the DTD is configured to receive data, it may be copied from the radio to the DTD by pressing **COPY** line select key on the **DATA FILL** page.

1. Initialize the data transfer device (DTD). Connect the DTD to the **DATA** connector.

2. With the **FILL** page selected, **DATA** line select key - Press.

NOTE

Pressing **RTN** line select key on **DATA FILL** page stops the fill process.

3. On the **DATA FILL** page, **FILL** line select key - Press. **FILL ENABLED** screen will appear.
4. Start data fill on DTD. Monitor DTD to see when data transfer is complete.

3.12A.4.3 Load Secure Keys. Key fill contains secure information needed for ALE link protection and ECCM operation.

1. Initialize the DTD. Connect the DTD to the **KEY** connector.
2. With the **FILL** page selected, **KEY** line select key - Press.

NOTE

Pressing **RTN** line select key on **KEY FILL** page stops the fill process.

3. On the **KEY FILL** page, **LOAD** line select key - Press. **FILL ENABLED** message will appear.
4. Start keyfill on DTD. Monitor DTD to see when data transfer is complete.

3.12A.4.4 Zero Secure Keys.

1. Access **KEY FILL** page. From **FILL** screen, **KEY** fixed function key - Press.

2. **ZERO** line select key - Press.
3. Select key to zero with **VALUE** keys. Default is all keys.

NOTE

If you do not want to zero the key, press **NO**. The **FILL** screen will then appear.

4. Confirm zero by pressing **YES** line select key. **ZEROIZE** advisory message will appear, followed by the **FILL** screen.

3.12A.4.5 Emergency (EMER) Operation. The mode, frequency, and net to be used in the **EMER** position is determined by the datafill. To use the emergency mode, do the following:

1. Function switch - **T/R**.
2. Mode switch - **EMER**.
3. ICS Transmitter selector - Position **5**.
4. Radio push-to-talk switch - Press to talk; release to listen.

3.12A.5 Shutdown.

1. Function switch - **OFF**.
2. To erase all preprogrammed information, Function switch - Pull and turn to **ZERO (PULL)**.

3.12A.6 Messages. Table 3-2 lists display advisory messages that may appear during operation of the radio:

Table 3-2. AN/ARC-220 Messages

ADVISORY	MEANING	ACTION
ALE - NO DATA	ALE mission data not loaded.	Load mission data.
ALE - NO KEYS	ALE link protection keys not loaded.	Load keys.
CALL FAIL	Radio failed to complete an outgoing call.	
CALLING	Radio is placing an ALE call to another address.	

Table 3-2. AN/ARC-220 Messages (Cont)

ADVISORY	MEANING	ACTION
CDU FAIL	Radio set control is inoperative.	
CHANNEL BUSY	ALE or ECCM net is in use.	Wait or try another net.
CHANNEL INOP	ALE or ECCM keys are not loaded, or not correct.	
CHECK MSG	A data message has been received.	
COMPLETE	Indicated power-up BIT is complete.	
COPY COMPLETE	Copying process finished successfully.	
COPY FAIL	Copying process was unsuccessful.	
COPYING DATA	The radio is copying datafill contents from DTS.	
ECCM - NO DATA	ECCM data not installed.	Load mission data.
ECCM - NO KEYS	ECCM keys not installed.	Load keys.
EMER	Mode or net selected for emergency communication is inoperative.	
EMERG - NO KEYS	No keys available for net selected for emergency communication.	Load keys.
EOM	End of message.	
EXT FAIL	Radio failed due to external device, such as antenna.	
GO DATA	Link quality analysis values too low for reliable voice communication; data transmissions recommended.	
GPS FAIL	Position report could not be issued.	
GPS TIME FAIL	Current time could not be established via GPS receiver.	
HELD	ALE call being held in specific frequency by operator.	
INCOMING CALL	Another radio is establishing an ALE link.	
INOP MODES EXIST	Warning to expect inoperative modes.	
LINKED	An ALE link is established.	

Table 3-2. AN/ARC-220 Messages (Cont)

ADVISORY	MEANING	ACTION
LOAD COMPLETE	Keys and data successfully loaded into radio.	
LOAD FAIL	Keys and data not successfully loaded into radio.	
LOADING DATA	Radio currently loading data.	
LOADING KEYS	Radio currently loading keys.	
MSG ABORT	Radio discontinuing sending of current message.	
NET INOP	Selected net contains no data, corrupted data, or hardware cannot support the selected mode of operation.	
NO AUTO XMT	Radio has been instructed not to make any automatic transmissions.	
NO DATA	Database is not filled with necessary data to perform requested operations.	
NO KEYS LOADED	Keys are not loaded for current selected mode or net.	
NO RCVD MSGS	No messages have been received.	
PAC FAIL	Failure of radio in PA coupler.	
PLGR	Precision lightweight GPS receiver.	
POSN RPT FAIL	Current GPS position report not loaded.	
PRE - NO DATA	Preset data not loaded.	
PTT FOR XMIT BIT	Instruction to press microphone PTT switch to enable transmission BIT.	
RCV BIT - GO	Receiver BIT functions completed without failure.	
RCV READY	Ready to receive ECCM transmissions.	
RCVG PREAMBLE	ECCM preamble being received.	
RCVG DATA	Radio currently receiving data.	
RT-CDU COMM FAIL	Receiver-transmitter is failing to communicate with the radio set control.	
RT FAIL	Receiver Transmitter inoperative.	

Table 3-2. AN/ARC-220 Messages (Cont)

ADVISORY	MEANING	ACTION
RX-TX DEGRADED	Receive and transmit capabilities are degraded.	
RX-TX FAIL	Radio cannot receive or transmit.	
SENDING DATA	Radio currently sending data.	
SENDING POSN	Sending GPS position report.	
SOUND	Radio sending an ALE sound.	
SYNCING	Time synchronization being performed.	
TESTING	BIT in progress.	
TIME SYNC FAIL	Radio failed in attempt to synchronize.	
TRANSEC FAIL	BIT detected a failure that will not allow ECCM operation.	
TUNE XX%	Indicates percentage of ECCM frequencies tuned for current net.	
TUNING	Radio is currently tuning itself.	
TX DEGRADED	BIT detected a failure that is causing transmission capability to be degraded.	
TX FAIL	Radio cannot transmit.	
UNSYNC	ECCM is not synchronized.	
UNTUNED	An ECCM hop set is not tuned.	
XMT READY	Radio is ready to transmit in ECCM mode.	
ZEROIZED	All mission datafill and keys have been erased.	

3.12B TSEC/KY-100 SECURE COMMUNICATION SYSTEM.

The TSEC/KY-100 provides secure, half duplex voice, digital data, analog data and remote keying capabilities for transmission over the AN/ARC-220 HF radio. It has six operational modes, and can store often used settings on presets. Power is supplied from the No. 1 dc primary bus through a circuit breaker marked **HF SCTY SET**.

3.12B.1 Controls and Functions. The KY-100 is controlled by a control display unit (CDU) located behind the

lower console (Figure 3-12.2). The function of each control and display is as follows:

CONTROL	FUNCTION
AUDIO	Speaker for audio tones.
CIK	Cryptographic Ignition Key. Not used in this installation.
FILL connector	Used to connect external fill device to KY-100.

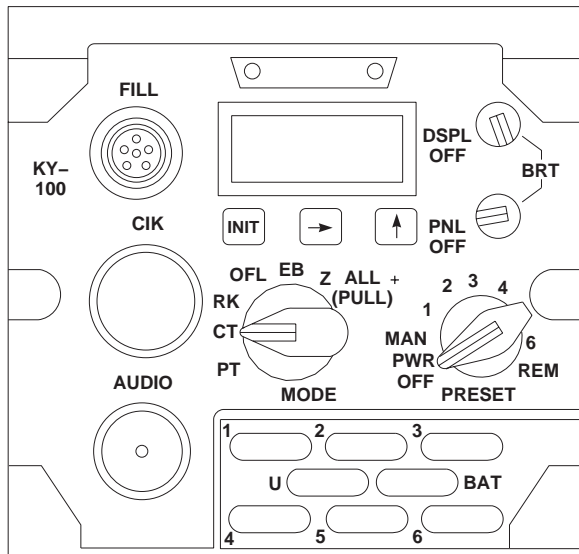

AB0987
SA

Figure 3-12.2. KY-100 Secure Communication Control Panel

CONTROL	FUNCTION
PT	Sets KY-100 to plaintext mode.
CT	Sets KY-100 to ciphertext mode.
RK	Allows cooperative terminal rekeying in receive mode.
OFL	Sets KY-100 to off line mode. Disables communications and accesses screens to select mode settings, test, and fill screens.
EB	Select emergency back-up key.
Z ALL (PULL)	Erases all cryptographic data (keys) except the emergency back-up key.

3.12B.2 Modes of Operation.

3.12B.2.1 Plaintext (PT) Mode. The ICS voice signal is routed through the KY-100 to and from the HF radio, with no processing. Radio transmits and receives unencrypted information.

3.12B.2.2 Cyphertext (CT) Mode. The ICS voice signal is routed to the KY-100, where it is processed, encrypted and sent to the HF radio for transmission. Received audio signals from the HF radio are processed, decoded, and sent to ICS. Unencrypted information is routed through the KY-100 if CT ONLY is not selected in configuration settings. Non cooperative rekey receive is possible only in this mode.

3.12B.2.3 Rekey Mode. Use this mode to fill crypto information. The data transfer device must be connected to **FILL** to load keys.

3.12B.2.4 Off-line (OFL) Mode. For maintenance use to configure and test the system. Communications are not possible in this mode.

3.12B.2.5 Emergency Backup (EB) Mode. Enables a zeroized terminal to be used for voice privacy operation, only. Key is not erased when terminal is zeroized. This mode is not to be used to transmit classified information.

3.12B.2.6 Zeroize (Z ALL) Mode. Erases all keys in the KY-100 except the emergency back-up key.

CONTROL	FUNCTION
INIT , ↵ and ⬅	Function keys used to access and navigate in software menus.
DSPL OFF	Varies light intensity of display. Display turned off in OFF position.
PNL OFF	Varies light intensity of backlit display panel. Display turned off in OFF position.
PRESET switch	Controls power to set, and which key is active.
PWR OFF	Removes power from set.
MAN	Manual rekeying enabled.
1,2,3,4,5,6	Selects preset settings for use.
REM	Allows control of KY-100 from a remote control unit (RCU).
MODE switch	

3.12B.3 Operation.

3.12B.3.1 Keyfill Operation. When there are no TEKs in the KY-100 at start up, the display will read **CLd STRT**. If there are TEKs in the terminal, skip steps 3 and 6, and load or update keys as required.

1. **MODE** switch - **OFFLINE**.
2. **PRESET** switch - **MAN**.
3. Wait until **CLd STRT** is displayed, then **INIT** key - Press.
4. Connect a fill device to **FILL** connector.
5. Turn on device and select key to be loaded.
6. **INIT** key - Press. At the end of the fill sequence, a tone should be heard in the headset, and **KEY 1 01**, **CIK OK**, and **PASS** will appear. The key that was loaded is stored in fill position 1.
7. To fill the rest of the keys, push the **▲** or **◆** key until **KEY OPS** is displayed.
8. **INIT** key - Push twice. **LOAD KEY**, then **LOAD X** will be displayed with the flashing **X** being the number of currently selected key location.
9. Press the **▲** or **◆** key until the desired location (**1, 2, 3, 4, 5, 6**, or **U**) is displayed.
10. **INIT** key - Press. The entire **LOAD X** display will flash.
11. Turn on device and select key to be loaded.
12. **INIT** key - Press. At the end of the fill sequence, a tone should be heard in the headset, and **KEY X** will appear. The display will then change to **LOAD X** with the flashing **X** being the number of currently selected key location.
13. Repeat steps 9. through 11. until all required locations are filled.
14. When all keys are transferred, turn off the fill device, and disconnect it from **FILL** connector.
15. To exit key load, place **MODE** switch out of **OFFLINE**.

3.12B.3.2 Normal Operation.

1. **MODE** switch - **PT**, or **CT**.
2. **PRESET** switch - **MAN, 1, 2**, or **3**.

3.12B.3.3 Emergency Operation.

NOTE

Emergency key is not secure. Do not transmit classified information in this mode.

1. **MODE** switch - **EB**.
2. **PRESET** switch - **MAN, 1, 2**, or **3**.

3.12B.3.4 Zeroize All Keys.

NOTE

Power does not have to be applied to unit to zero all keys.

Emergency backup key is not zeroized in this procedure.

1. **MODE** switch - Pull and rotate to **Z ALL (PULL)**.

3.12B.3.5 Zeroize Specific Keys.

1. **MODE** switch - **OFFLINE**.
2. **UP ARROW**, or **RIGHT ARROW** soft key - Press, until **KEY OPS** is displayed.
3. **INIT** key - Press. **LOAD KEY** will be displayed.
4. **UP ARROW**, or **RIGHT ARROW** key - Press, until **ZERO** is displayed.
5. **INIT KEY** soft key - Press. **ZERO X**, with a flashing number (**X**) appears. The flashing number indicates the currently selected key to be zeroized.

NOTE

Number of keys is 1 through 6 TEKs, U (used to update internal keys) and Eb (emergency backup key).

6. **UP ARROW**, or **RIGHT ARROW** key - Press, until key number to zeroize is displayed.
7. **INIT** key - Press. The entire **ZERO X** will now flash.
8. **INIT** key - Press. The screen will blank while zeroizing process takes place. When zeroizing is complete, a tone will be heard in the headset, the display will briefly change to **ZEROED X**, and then revert to **ZERO X**.

9. Repeat steps 6 through 8 to zero other key positions, as desired.

10. When all desired key positions are zeroized, **MODE** switch - Move to any other position.

3.12B.4 Shutdown.

PRESET switch - **PWR OFF**.

3.12B.5 Configuration.

Configure as described in Appendix C.

Section III NAVIGATION

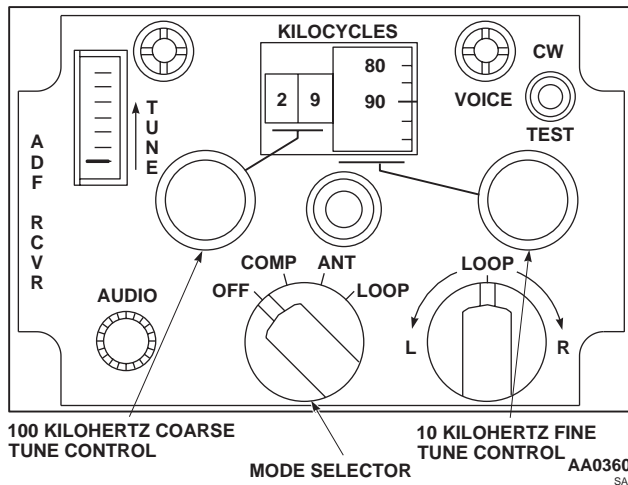

Figure 3-13. LF/ADF Control Panel C-7932/ARN-89

3.13 DIRECTION FINDER SET AN/ARN-89. (LF/ADF).

Direction Finder set AN/ARN-89 (Figure 3-13) is an airborne, low frequency (LF), automatic direction finder (ADF) radio, that provides an automatic or manual compass bearing on any radio signal within the frequency range of 100 to 3,000 kHz. The ADF can identify keyed or continuous wave (CW) stations. The ADF displays the bearing of the helicopter relative to a selected radio transmission on the horizontal situation indicator No. 2 bearing pointer (Figure 3-31). When ADF is selected on the **MODE SEL** panel (Figure 3-32) three modes of operation permit the system to function: as a CW automatic direction finder, as a CW manual direction finder or as an amplitude-modulated (AM) broadcast receiver. Power to operate the Direction Finder AN/ARN-89 is provided by No. 1 dc primary bus through a circuit breaker, marked **ADF**, and the ac essential bus through a circuit breaker, marked **26VAC INST**.

3.13.1 Antennas. The ADF sense antenna is a part of the VHF/FM No. 2, VHF/AM, antenna (Figure 3-1) under the nose section of the helicopter. The ADF loop antenna is flush-mounted, under the center fuselage section.

3.13.2 Controls and Functions. Controls for the LF/ADF receiver are on the front panel of the unit (Figure 3-13). The function of each control is as follows:

CONTROL	FUNCTION
Mode selector switch	
OFF	Turns power off.
COMP	Provides operation as an ADF.
ANT	Provides for operation as an AM receiver using sense antenna.
LOOP	Provides for receiver operation as a manual direction finder using loop only.
LOOP L-R control switch	Provides manual left and right control of loop when operating mode selector in LOOP position. It is spring loaded to return to center.
AUDIO	Adjusts volume.
100 Kilohertz coarse-tune control knob	Tunes receiver in 100-kHz steps as indicated by first two digits of KILOCYCLES indicator.
10 Kilohertz fine-tune control knob	Tunes receiver in 10 kHz steps as indicated by last two digits of KILOCYCLES indicator.
CW, VOICE, TEST switch	
CW (COMP mode)	Enables tone oscillator to provide audible tone for tuning to CW station, when mode function switch is at COMP .
CW (ANT or LOOP mode)	Enables beat frequency oscillator to permit tuning to CW station, when mode function switch is at ANT or LOOP .
VOICE	Permits low frequency receiver to operate as a receiver with mode switch in any position.

CONTROL	FUNCTION
TEST (COMP mode)	Provides slewing of loop through 180° to check operation of receiver in COMP mode. (Switch position is inoperative in LOOP and ANT mode.)
TUNE meter	Indicates relative signal strength while tuning receiver to a specific radio signal.
KILOCYCLES indicator	Indicates operating frequency to which receiver is tuned.

3.13.3 Operation.

3.13.3.1 Starting Procedure.

1. ICS NAV receiver selector - **ON**.
2. Mode selector - **COMP**, **ANT**, or **LOOP**.
3. Frequency - Select.
4. **CW**, **VOICE**, **TEST** switch - **CW** or **VOICE** as appropriate.
5. ICS NAV switch - **ON**.
6. Fine tune control - Adjust for maximum upward indication on **TUNE** meter.
7. **AUDIO** control - Adjust as desired.

3.13.3.2 ANT Mode Operation.

1. Mode selector - **ANT**.
2. ICS NAV switch - **ON**.
3. Monitor receiver by listening.

3.13.3.3 COMP Mode Operation.

1. Mode selector - **COMP**.
2. **MODE SEL BRG 2** HSI/VSI switch - **ADF**.
3. The horizontal situation indicator No. 2 bearing pointer displays the magnetic bearing to the ground station from the helicopter, as read against the compass card, when **ADF** is selected on the **MODE SEL BRG 2** switch.

4. ICS NAV switch - **ON**.
5. To test the ADF, when required:
 - a. **CW**, **VOICE**, **TEST** switch - **TEST**. Check to see that No. 2 bearing pointer changes about 180°.
 - b. **CW**, **VOICE**, **TEST** switch - Release.

3.13.3.4 LOOP Mode Operation. Manual direction finding uses the **LOOP** mode.

1. Mode selector switch - **LOOP**.
2. ICS NAV switch - **ON**.
3. Turn **LOOP L-R** switch to **L** (left) or **R** (right) to obtain an audio null and a **TUNE** indicator null. Watch HSI No. 2 bearing pointer for a display of magnetic bearing to or from ground station as read against the compass card. In this mode of operation, two null positions 180° apart are possible.

3.13.4 Stopping Procedure. Mode selector - **OFF**.

3.14 DIRECTION FINDER SET AN/ARN -149 (LF/ADF) (IF INSTALLED).

The AN/ARN -149 (Figure 3-14) is a low frequency (LF), automatic direction finder (ADF) radio, providing compass bearing capability within the frequency range of 100 to 2199.5 kHz. The **ADF** has two functional modes of operation: **ANT** and **ADF**. The antenna (**ANT**) mode functions as an aural receiver, providing only an aural output of the received signal. The **ADF** mode functions as an automatic direction finder, providing a relative bearing-to-station signal to the horizontal situation indicator No. 2 bearing pointer and an aural output. A **TONE** submode of operation can be selected in either **ANT** or **ADF** mode, providing a 1000-Hz aural output to identify keyed **CW** signals. Power is provided to the LF/ADF system by the No. 1 dc primary bus through a circuit breaker, labeled **ADF**, and the ac essential bus through a circuit breaker, labeled **26 VAC INST**.

3.14.1 Antennas. The antenna system is a single combination antenna containing both loop and sense elements. The RF signal from one loop element is modulated with a reference sine signal while the other loop element is modulated with a reference cosine signal. The two modulated signals are combined, phase shifted 90°, and amplified. The resulting loop signal is summed with the sense antenna sig-

nal and sent to the ADF radio for visual and aural execu-

tion. The antenna configuration is flush mounted under the bottom cabin fuselage (Figure 3-1).

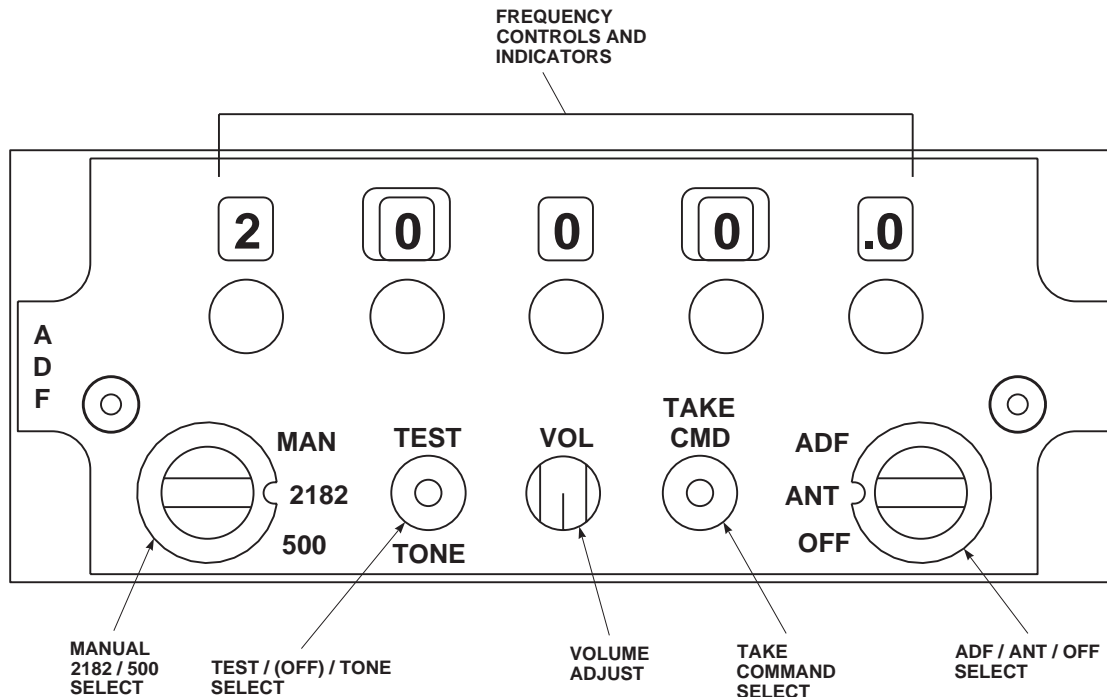

FS0015A
SA

Figure 3-14. LF/ADF Control Panel AN/ARN-149

3.14.2 Controls and Functions. Controls and frequency digit displays are on the front of the ADF control panel (Figure 3-14). The function of each control is as follows:

CONTROL	FUNCTION
Frequency controls and indicators	Controls and indicates the selected frequency when MAN/2182/500 switch is in MAN .
MAN/2182/500 select	
MAN	Enables the frequency controls and indicators.
2182	Selects 2182 kHz as the operating frequency.
500	Selects 500 kHz as the operating frequency.

CONTROL	FUNCTION
TEST/(OFF)/TONE select	TEST position (up) is a momentary position that enables a self-test. Center position is off. TONE position (down) enables the tone generator for CW operation.
VOL adjust	A 12-position switch controlling volume in 12 discrete steps.
TAKE CMD select	Used in a dual ADF control panel installation allowing each to take control of the receiver away from the other. Not used in this installation.
ADF/ANT/OFF select	
ADF	Applies power to system and turns on ADF and aural capability.
ANT	Applies power to system and turns on antenna or aural function only.
OFF	Removes power from system.

3.14.3 Operation.

3.14.3.1 ANT (Aural Only) Operation.

1. ICS NAV receiver selector switch - ON.
2. **ADF/ANT/OFF** switch - **ANT**.
3. **MAN/2182/500** switch - As desired.

If **MAN** is selected in step 3:

4. Frequency switches 5. - Select.
5. **VOL** control - Adjust as desired.
6. **TEST/(OFF)TONE** switch - **TONE**.

3.14.3.2 ADF Operation.

1. ICS NAV receiver selector switch - ON.
2. **HSI/VSI MODE SEL BRG 2** switch - **ADF**.
3. **ADF/ANT/OFF** switch - **ADF**.
4. **MAN/2182/500** switch - As desired.

If **MAN** is selected in step 4:

5. Frequency controls 5. - Select.
6. **VOL** control - Adjust as desired.

If CW operation is desired:

7. **TEST/(OFF)TONE** switch - **TONE**.
8. Verify horizontal situation indicator (HSI) No. 2 bearing pointer displays appropriate relative bearing-to-the-station.

If self-test is required:

9. **TEST/(OFF)TONE** switch - **TEST** (position up and hold).
10. No. 2 bearing pointer deflects 90° away from original reading.
11. **TEST/(OFF)TONE** switch - Release to off.
12. Verify No. 2 bearing pointer returns to original reading.

3.14.4 Stopping Procedure. **ADF/ANT/OFF** switch - **OFF**.

3.15 RADIO RECEIVING SET AN/ARN-123(V) (VOR/ILS/MB).

Radio set AN/ARN 123(V) (Figure 3-15) is a very high-frequency receiver that operates from 108.00 to 117.95 MHz. Course information is presented by the VSI course deviation pointer and the selectable No. 2 bearing pointer on the horizontal situation indicator. The combination of the glide slope capability and the localizer capability makes up the instrument landing system (ILS). The marker beacon portion of the receiver visually indicates on the VSI **MB** advisory light, and aurally indicates on the headphones, of passage of the helicopter over a marker beacon transmitter. The receiving set may be used as a VOR receiver, or ILS receiver. The desired type of operation is selected by tuning the receiving set to the frequency corresponding to that operation. ILS operation is selected by tuning to the odd tenth MHz frequencies between 108.0 and 112.0 MHz. VOR operation is selected by tuning in .050 MHz units to the frequencies between 108.0 and 117.95 MHz, except the odd tenth MHz between 108.0 and 112.0 MHz, which are reserved for ILS operation. The three receiver sections do the intended functions independent of each other. Performance degradation within any one of the major sections will not affect the performance of the others. Power for the AN/ARN-123 is provided from the dc essential bus through a circuit breaker, marked **VOR/ILS**.

NOTE

Tuning to a localizer frequency will automatically tune to a glide slope frequency, when available.

3.15.1 Antenna. The VOR/LOC antenna system (Figure 3-1), consists of two blade type collector elements, one on each side of the fuselage tail cone. The glide slope antenna is mounted under the avionics compartment in the nose. The antenna provides the glide slope receiver with a matched forward-looking receiving antenna. The marker beacon antenna is flush-mounted under the center section of the fuselage.

3.15.2 Controls and Functions. The controls for the VOR/ILS/MB receivers are on the front panel of the unit. The function of each control is as follows:

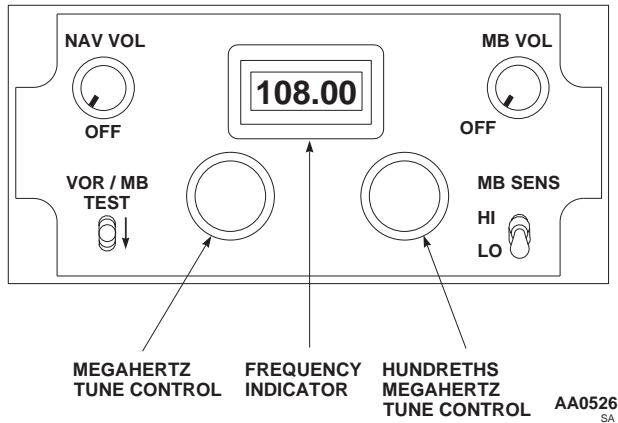

Figure 3-15. Radio Receiving Set AN/ARN-123(V)

CONTROL	FUNCTION
NAV VOL-OFF control	Turns VOR/ILS receiver on and off, adjusts volume.
MB VOL-OFF control	Turns marker beacon receiver on and off; adjusts volume.
Megahertz tune control	Tunes VOR/ILS receiver in MHz as indicated on frequency indicator.
Hundredths megahertz tune control	Tunes VOR/ILS receiver in hundredths MHz as indicated on frequency indicator.
VOR/MB TEST control	Activates VOR test circuit and MB receiver lamp self-test circuits.
MB SENS HI-LO control	For controlling MB sensitivity.
LO	Decreases receiver sensitivity by shortening time transmitted signal will be received.
HI	Increases receiver sensitivity by lengthening time transmitted signal will be received.

3.15.3 Operation.

3.15.3.1 Starting Procedure.

1. ICS **AUX** selector - **ON**.

2. **NAV VOL OFF** control - **On**.
3. Frequency - **Select**.
4. **MODE SEL BRG 2** switch - **VOR**.
5. **MODE SEL VOR/ILS** switch - **VOR**.

3.15.3.2 VOR/Marker Beacon Test.

NOTE

If acceptable signal is not received, test will not be valid.

1. HSI **CRS** set 315° on **COURSE** set display, pilot and copilot.
2. **VOR/MB TEST** switch - Down and hold. The **MB** light on the VSI should go on.
3. HSI VOR/LOC course bar and VSI course deviation pointer - Centered ± 1 dot.
4. No. 2 bearing pointer should go to the 310° to 320° position.
5. To-from arrow should indicate - **TO**.
6. **VOR/MB TEST** switch - Release.

3.15.3.3 VOR Operation. Course - Set.

3.15.3.4 ILS (LOC/GS) Operation. ILS operation frequency - Set.

3.15.3.5 Marker Beacon (MB) Operation.

1. **MB VOL OFF** switch - **On**.
2. **MB SENS** switch - As desired.

3.15.3.6 VOR Communications Receiving Operation. Frequency - Set.

3.15.4 Stopping Procedure. NAV VOL OFF switch - **OFF**.

3.16 RADIO RECEIVING SET AN/ARN-147(V)(VOR/ILS/MB)(IF INSTALLED).

Radio set AN/ARN-147 (V) (Figure 3-16) is a very high frequency receiver, capable of operating from 108.0 to 126.95 MHz. Course information is presented by the vertical situation indicator deviation pointer and the selectable

No. 2 bearing pointer on the horizontal situation indicator. The combination of the glide slope and localizer capabilities makes up the instrument landing system (ILS). The marker beacon portion of the receiver visually indicates on the vertical situation indicator **MB** advisory light, and aurally signals over the headphones helicopter passage over a transmitting marker beacon. The radio set may be used as a VHF omnirange (VOR) or ILS receiver. The desired type of operation is selected by tuning the receiving set to the frequency corresponding to that operation. ILS operation is selected by tuning to the odd tenth MHz frequencies from 108.0 to 111.95 MHz. VOR operation is selected by tuning from 108.0 to 126.95 MHz, except the odd tenth MHz from 108.0 to 111.95 MHz reserved for ILS operation. The three receiver sections do the intended functions independent of each other. Performance degradation within any one of the major sections will not affect performance of the others. Power for the AN/ARN-147 is provided from the dc essential bus through a circuit breaker, labeled **VOR/ILS**.

NOTE

Tuning to a localizer frequency will automatically tune to a glide slope frequency when available.

3.16.1 Antennas. The VOR/LOC antenna system (Figure 3-1) consists of two blade type collector elements, one on each side of the fuselage tail cone. The glide slope antenna is mounted under the avionics compartment in the nose. The antenna provides the glide slope receiver with a matched forward looking receiving antenna. The marker beacon antenna is flush-mounted under the center section of the fuselage.

3.16.2 Controls and Functions. The controls for the VOR/ILS/MB receivers are on the front of the control panel (Figure 3-16). The function of each control is as follows:

CONTROL	FUNCTION
Digit window	Indicates selected operating frequency.
NAV VOL adjust	Varies navigation (VOR/LOC) audio gain of associated receiver.
KHz digits select	Changes frequency in 50-kHz steps over the range of control (last two digits).
TEST/(power) ON/OFF select	Controls application of power to the associated receiver. Controls VOR/marker beacon test.

CONTROL	FUNCTION
MB HI/LO select	Varies marker beacon (MB) sensitivity (high or low).
MHz digits select	Changes frequency in 1-MHz steps over the range of control (first three digits).
MB VOL adjust	Varies marker beacon (MB) audio gain of the associated receiver.

3.16.3 Operation.

3.16.3.1 Starting Procedure.

1. ICS AUX receiver selector switch - **ON**.
2. TEST/(pwr) ON/OFF switch - **ON** (center position).
3. MHz (first three digits) control - Select.
4. KHz (last two digits) control - Select.
5. NAV VOL control - Adjust.
6. MODE SEL BRG 2 switch - **VOR**.
7. MODE SEL VOR/ILS switch - **VOR**.
8. CIS MODE SEL NAV/ON switch - As desired.

3.16.3.2 VOR/Marker Beacon Test.

NOTE

Test will not be valid if signal reception is invalid.

1. HSI CRS control (pilot and copilot) - Set 315° in course display.
2. TEST/(pwr) ON/OFF switch - **TEST** (position up and hold). VSI MB advisory light goes on.
3. HSI VOR/LOC course bar and VSI course deviator pointer - Centered (±1 dot).
4. No. 2 bearing pointer - 315° (±5°).
5. To-from arrow - **TO**.

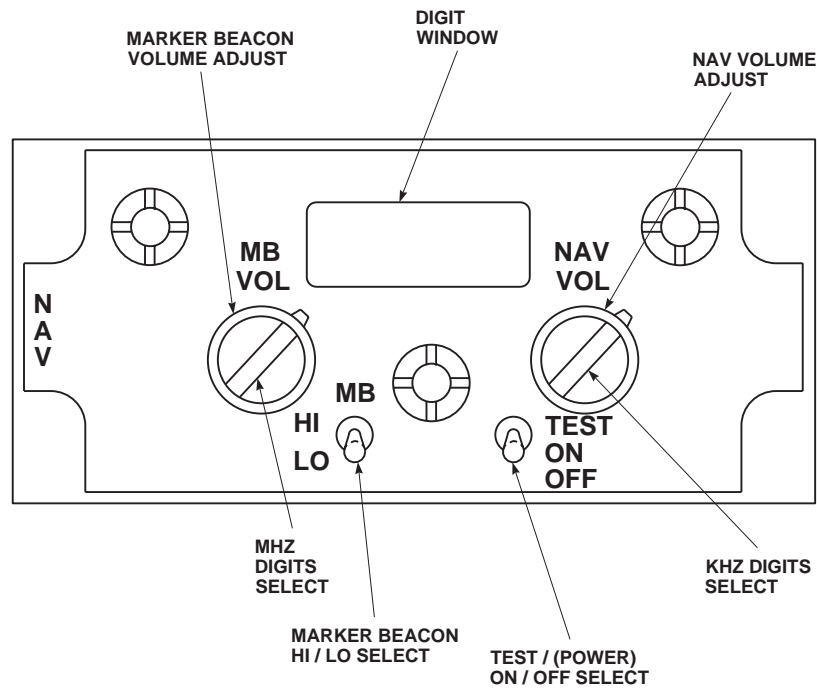

FS0016A
SA

Figure 3-16. VOR/ILS/MB Control Panel AN/ARN-147 (V)

6. **TEST/(pwr) ON/OFF** switch - Release.

3.16.3.3 VOR Operation. HSI CRS control - Course select.

3.16.3.4 ILS (LOC/GS) Operation.

1. ILS operation frequency/volume - Set.
2. HSI CRS control - Course select.
3. **CIS MODE SEL NAV/ON** switch - As desired.

3.16.3.5 Marker Beacon (MB) Operation.

1. ICS NAV receiver selector switch - ON.
2. **MB HI/LO** switch - As desired.
3. **MB VOL** control - Adjust as desired.

3.16.3.6 VOR Communications Receiving Operation. Frequency/Volume - Set.

3.16.4 Stopping Procedure. **TEST/(pwr) ON/OFF** switch - **OFF**.

3.17 DOPPLER NAVIGATION SET AN/ASN-128. UH

The Doppler navigation set, AN/ASN-128, in conjunction with the helicopter's heading and vertical reference systems, provides helicopter velocity, position, and steering information from ground level to 10,000 feet. To achieve best results with the set, pitch and roll angles should be limited to 30° pitch and 45° roll, and moderate maneuver rates should be employed. The Doppler navigation system is a completely self-contained navigation system and does not require any ground-based aids. The system provides world-wide navigation, with position readout available in both Universal Transverse Mercator (UTM) and Latitude and Longitude (LAT/LONG)(Figure 3-22). Navigation and steering is done using LAT/LONG coordinates, and a bilateral UTM-LAT/LONG conversion routine is provided for UTM operation. Up to ten destinations may be entered in either format and not necessarily the same format. Present position data entry format is also optional and independent of destination format. Power to operate the AN/ASN-128 is provided from No. 1 dc primary bus through a circuit breaker marked **DPLR**, and from the ac essential bus through a circuit breaker, marked **26 VAC DPLR**, refer to TM 11-5841-281-12.

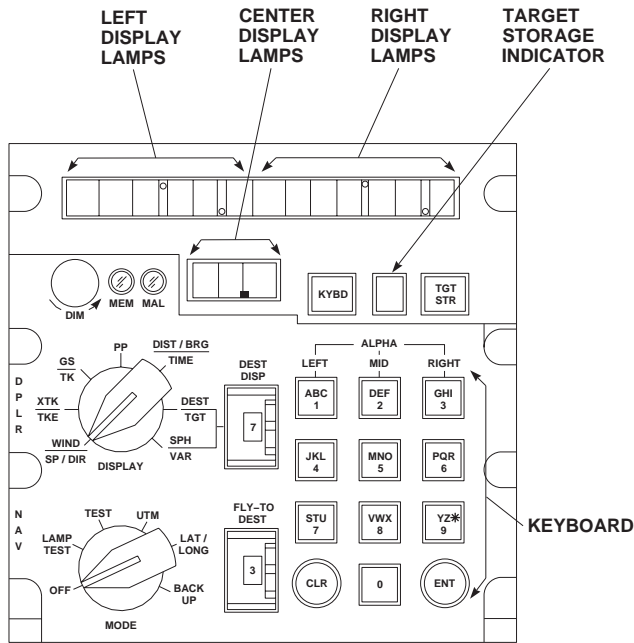

AA0663
SA

Figure 3-17. Doppler Navigation Set AN/ASN-128

3.17.1 Antenna. The Doppler antenna (Figure 3-1) consists of a combined antenna/radome and a receiver-transmitter housing below copilot's seat. The combination antenna/radome uses a printed-grid antenna.

3.17.2 Controls, Displays, and Function. The control and displays for the Doppler are on the front panel (Figure 3-17). The function of each control is as follows:

CONTROL/INDICATOR	FUNCTION
MODE selector	Selects Doppler Navigation Mode of operation.
OFF	Turns navigation set off.
LAMP TEST	Checks operation of all lamps.
TEST	Initiates built-in-test exercise for navigation set.
UTM	Selects Universal Transverse Mercator (UTM) navigational mode of operation.

CONTROL/INDICATOR	FUNCTION
LAT/LONG	Select latitude/longitude navigational mode of operation.
BACKUP	Places navigation set in estimated mode of operation or estimated velocity mode of operation.
DISPLAY selector	Selects navigation data for display.
WIND SP/DIR	Not applicable.
XTK/TKE (Left Display)	Distance crosstrack (XTK) of initial course to destination in km and tenths of a km.
(Right Display)	Track angle error (TKE) in degrees displayed as right or left of bearing to destination.
GS-TK (Left Display)	Ground speed (GS) in km/hr.
(Right Display)	Track angle (TK) in degrees TRUE.
PP with switch set to UTM (Center Display)	Present position UTM zone.
(Left Display)	Present position UTM area square designator and easting in km to nearest ten meters.
(Right Display)	Present position UTM area northing in km to nearest ten meters.
PP with MODE switch set to LAT/LONG (Left Display)	Present position latitude in degrees, minutes and tenths of minutes.
(Right Display)	Present position longitude in degrees, minutes and tenths of minutes.
DIST/BRG-TIME (Center Display)	Time to destination selected by FLY TO DEST (in minutes and tenth of minutes).
(Left Display)	Distance to destination selected by FLY TO DEST (in km and tenths of a km).

CONTROL/ INDICATOR	FUNCTION
(Right Display)	Bearing to destination selected by FLY TO DEST (in degrees MAGNETIC).
DEST-TGT (Mode switch set to UTM) (Center Display)	UTM zone of destination selected by DEST DISP thumbwheel.
(Left Display)	UTM area and easting of destination set on DEST DISP thumbwheel.
(Right Display)	Northing of destination set on DEST DISP thumbwheel.
DEST-TGT (Mode switch set to LAT/LONG) (Left Display)	Latitude (N 84° or S 80° max.) of destination set on DEST DISP thumbwheel.
(Right Display)	Longitude of destination set on DEST DISP thumbwheel.
SPH-VAR (Left Display)	Spheroid code of destination set on DEST DISP thumbwheel.
(Right Display)	Magnetic variation (in degrees and tenths of degrees) of destination set on DEST DISP thumbwheel.
MEM indicator lamp	Lights when radar portion of navigation set is in nontrack condition.
MAL indicator lamp	Lights when navigation set malfunction is detected by built in self-test.
DIM control	Controls light intensity of display characters.
Left, Right, and Center display lamps	Lights to provide data in alphanumeric and numeric characters, as determined by setting of DISPLAY switch, MODE switch, and operation of keyboard.
Target storage indicator	Displays destination number (memory location in which present position will be stored when TGT STR pushbutton is pressed.
TGT STR pushbutton	Stores present position data when pressed.

CONTROL/ INDICATOR	FUNCTION
KYBD pushbutton	Used in conjunction with the keyboard to allow data to be displayed and subsequently entered into the computer when the ENT key is pressed.
DEST DISP thumbwheel switch	Destination display thumbwheel switch is used along with DEST-TGT and SPH-VAR position of DISPLAY switch to select destination whose coordinates or magnetic variation are to be displayed, or to be entered. Destinations are 0 through 9, P (Present Position) and H (Home).
Keyboard	Used to set up data for entry into memory. When the DISPLAY switch is turned to the position in which new data is required and the KYBD pushbutton is pressed, data may be displayed on the appropriate left, right, and center display. To display a number, press the corresponding key or keys (1 through 0). To display a letter, first depress the key corresponding to the desired letter. Then depress a key in the left, middle or right column, corresponding to the position of the letter on the key. Example: To enter an L, first depress L, then 3, 6, or 9 in the right column.
FLY-TO-DEST thumbwheel switch	Selects the destination for which XTK/TKE and DIST/BRG/TIME are displayed when the DISPLAY switch is turned to either of these positions which steering information is desired. Destinations are 0 through 9, and H (Home).
ENT key	Enters data set up on keyboard into memory when pressed.
CLR key	Clears last entered character when pressed once. When pressed twice, clears entire display panel under keyboard control.

3.17.3 Modes of Operation. The three basic modes of operation are: Navigate, test, and backup.

3.17.3.1 Test Mode. The TEST mode contains two functions: **LAMP TEST** mode, in which all display segments are lit, and **TEST** mode, in which system operation is verified. In the **LAMP TEST** mode, system operation is identical to that of the navigate mode except that all lamp segments and the **MEM** and **MAL** indicator lamps are lighted to verify their operation (Figure 3-18). In TEST mode, the system antenna no longer transmits or receives electromagnetic energy; instead, self-generated test signals are inserted into the electronics to verify operation. System operation automatically reverts into the backup mode during test mode. Self-test of the Doppler set is done using built-in-test equipment (BITE), and all units connected and energized for normal operation. Self-test isolates failures to one of the three units. The computer-display unit (except for the keyboard and display) is on a continuous basis, and any failure is displayed by turn-on of the **MAL** indicator lamp on the computer-display unit. The signal data converter and receiver-transmitter-antenna are tested by turning the **MODE** switch to **TEST**. Failure of those components is displayed on the computer-display unit by turn-on of the **MAL** indicator lamp. Identification of the failed unit is indicated by a code on the display panel of the computer-display unit. Continuous monitoring of the signal data converter and receiver-transmitter-antenna is provided by the **MEM** indicator lamp. The **MEM** indicator lamp will light in normal operation when flying over smooth water. However, if the lamp remains on for over 10 minutes, over land or rough water, there is a malfunction in the Doppler set. Then the operator should turn the **MODE** switch to **TEST**, to determine the nature of the malfunction. Keyboard operation is verified by observing the alphanumeric readout as the keyboard is used.

3.17.3.2 Navigate Mode. In the navigate mode (**UTM** or **LAT/LONG** position of the **MODE** selector), power is applied to all system components, and all required outputs and functions are provided. Changes in present position are computed and added to initial position to determine the instantaneous latitude/longitude of the helicopter. Destination and present position coordinates can be entered and displayed in **UTM** and latitude/longitude. At the same time, distance, bearing and time-to-go to any one of ten preset destinations are computed and displayed as selected by the **FLY-TO DEST** thumbwheel.

3.17.3.3 Backup Mode. In this mode, remembered velocity data are used for navigation. The operator can insert ground speed and track angle with the keyboard and the display in **GS-TK** position. This remembered velocity data can be manually updated through use of the keyboard and

CDU **DISPLAY** switch in the **GS-TK** position. When **GS-TK** values are inserted under these conditions, navigation continues using only these values.

3.17.4 Operation.

3.17.4.1 Window Display and Keyboard Operation.

In all data displays except **UTM** coordinates, the two fields are the left and right display windows. In **UTM** coordinates displays, the first field of control is the center window and the second field is the combination of the left and right displays. When pressing the **KYBD** pushbutton, one or other of the fields described above is under control. If it is not desired to change the display in the panel section under control, the pilot can advance to the next field of the display panel by pressing the **KYBD** pushbutton again. The last character entered may be cleared by pressing the **CLR** key. That character may be a symbol or an alphanumeric character. However, if the **CLR** key is pressed twice in succession, all characters in the field under control will be cleared and that field will still remain under control.

3.17.4.2 Data Entry.

1. To enter a number, press the corresponding key. To enter a letter, first press the key corresponding to the desired letter. Then press a key in the left, middle, or right column corresponding to the position of the letter on the pushbutton.
2. Example: To enter an L, first press L, then either 3, 6, or 9 in the right column. The computer program is designed to reject unacceptable data (for example, a **UTM** area of **WI** does not exist, and will be rejected). If the operator attempts to insert unacceptable data, the display will be blank after **ENT** is pressed.

3.17.4.3 Starting Procedure.

1. **MODE** selector - **LAMP TEST**. All lights should be lit.
 - a. Left, right, Center and Target storage indicator - Lit (Figure 3-18). All other lights should be on.
 - b. Turn **DIM** control fully clockwise, then fully counterclockwise, and return to full clockwise; all segments of the display should alternately glow brightly, go off, and then glow brightly.
2. **MODE** selector - **TEST**. After about 15 seconds left display should display **GO**. Ignore the

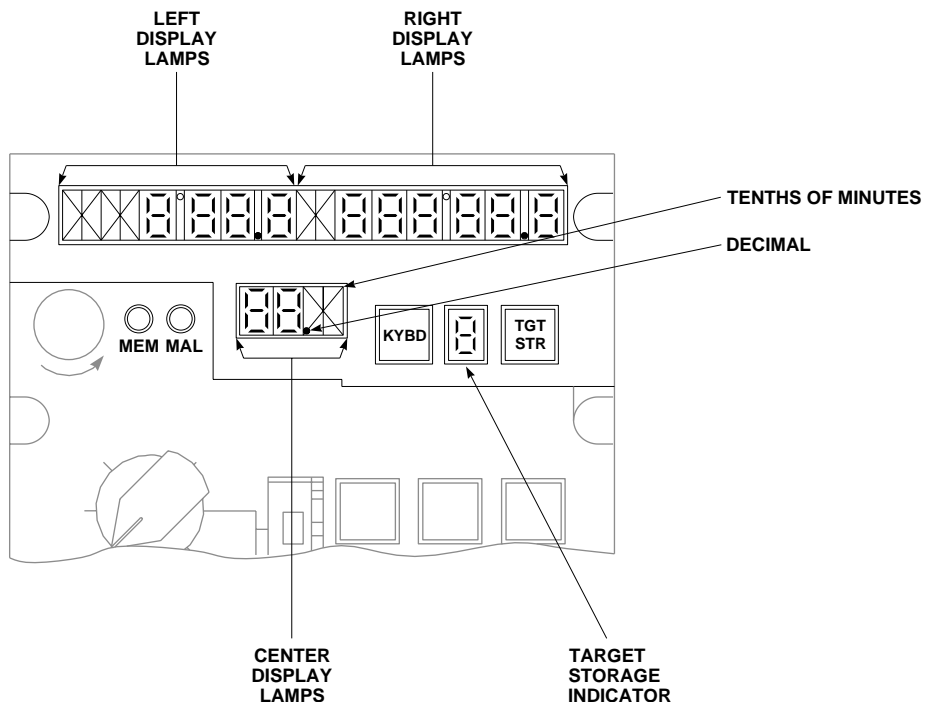

AA0525
SA

Figure 3-18. Doppler Lamp Test Mode Display

random display of alpha and numeric characters which occurs during the first 15 seconds. Also ignore test velocity and angle data displayed after the display has frozen. After about 15 seconds, one of the following five displays will be observed in the first two character positions in the left display:

NOTE

If the **MAL** lamp lights during any mode of operation except **LAMP TEST**, the computer-display unit **MODE** switch should be turned first to **OFF**, and then to **TEST**, to verify the failure. If the **MAL** lamp remains on after recycling to **TEST**, notify organizational maintenance personnel of the navigation set malfunction.

DISPLAY		REMARKS
LEFT	RIGHT	
GO	No display. Display blanks (normal).	If right display is blank, system is operating satisfactorily.

DISPLAY		REMARKS	DISPLAY		REMARKS
LEFT	RIGHT		LEFT	RIGHT	
GO	P	If right display is P, then pitch or roll data is missing, or pitch exceeds 90°. In this case, pitch and roll in the computer are both set to zero and navigation continues in a degraded operation. Problem may be in the vertical gyroscope or helicopter cabling.	MN	C, R, S, or H followed by a numeric code	A failure has occurred and the BACKUP mode, used for manual navigation (MN), is the only means of valid navigation. The operator may use the computer as a dead reckoning device by entering ground speed and track data. The operator should update present position as soon as possible, because it is possible significant navigation errors may have accumulated.
		NOTE	MN	HO10000	No heading information to signal data converter.
		If the TEST mode display is MN or NG, the MODE switch should be recycled through OFF to verify that the failure is not a momentary one. If the TEST mode display is MN, the data entry may be made in the UTM or LAT/LONG mode, but any navigation must be carried on with the system in the BACKUP mode.		SO5000	No 26 vac to signal data converter.
BU	C, R, S, or H followed by a numeric code	A failure has occurred and the system has automatically switched to a BACKUP mode of operation as follows: 1. The operator has the option of turning the MODE switch to BACKUP and entering the best estimate of ground speed and track angle. 2. The operator has the option of turning the MODE switch to BACKUP and entering his best estimate of wind speed and direction and entering his best estimate of ground speed and track angle. The operator should update present position as soon as possible, because it is possible that significant navigation errors may have accumulated.	NG	C, R, S, or H followed by a numeric code	A failure has occurred in the system and the operator should not use the system.
			EN		The 9V battery has failed. All stored data must be reentered after battery replacement.
			Blank	C with random numbers	Computer display unit failure.
			Blank	R with random numbers	Receiver-transmitter-antenna failure.
			Blank	S with random numbers	Signal data converter failure.
			Random display	Random display	Signal data converter failure.

3.17.4.4 Entering UTM Data. This initial data is inserted before navigating with the Doppler. Refer to paragraph 3.17.4.9.

- a. Spheroid of operation, when using UTM coordinates.
- b. UTM coordinates of present position - zone, area, easting (four significant digits) and northing (four significant digits; latitude/longitude coordinates may be used).
- c. Variation of present position to the nearest one-tenth of a degree.
- d. Coordinate of desired destination - 0 through 5 and H; (6 through 9 are normally used for target store locations; but may also be used for destinations). It is not necessary to enter all destinations in the same coordinate system.

NOTE

It is not necessary to enter destinations unless steering information is required, unless it is desired to update present position by overflying a destination, or unless a present position variation computation is desired (paragraph 3.17.3.3). If a present position variation running update is desired, destination variation must be entered. The operator may enter one or more destination variations to effect the variation update; it is not necessary for all destinations to have associated variations entered.

3.17.4.5 Entering Spheroid and/or Variation.

1. **MODE** selector - **UTM**, **LAT/LONG** or **BACKUP**.
2. **DISPLAY** selector - **SPH-VAR**.
3. **DEST DISP** thumbwheel - P, numeral, or H as desired.
4. **KYBD** pushbutton - Press. Observe display freezes and **TGT STR** indicator blanks. Press **KYBD** pushbutton again and observe left display blinks. If no spheroid data is to be entered, **KYBD** pushbutton -Press again, go to step 7.
5. Spheroid data - Entry. (Example: INØ). Press keys 3 (left window blanks), 3, 5, 5 and 0. Left display should indicate INØ. Refer to Figure 3-22 for codes.

6. **ENT** pushbutton - Press if no variation data is to be entered.
7. **KYBD** pushbutton - Press, if variation data is to be entered, and note right display blanks. (If no variation data is to be entered, **ENT** key - Press.)
8. Variation data - Enter. (Example: E001.2, press keyboard keys 2 (right window blanks), 2, 0, 0, 1 and 2. Press **ENT** key, the entire display will blank and **TGT STR** number will reappear, display should indicate INØ E 001.2.)

3.17.4.6 Entering Present Position or Destination In UTM.

1. **MODE** selector - **UTM**.
2. **DISPLAY** selector - **DEST-TGT**.
3. **DEST DISP** thumbwheel - P, numerical, or H as desired.
4. Present position and destination - Enter. (Example: Entry of zone 31T, area CF, easting 0958 and northing 3849.)
 - a. **KYBD** pushbutton - Press. Observe that display freeze and **TGT STR** indicator blanks.
 - b. **KYBD** button - Press. Observe that center display blanks.
 - c. Key 3, 1, 7, and 8 - Press.
 - d. **KYBD** button - Press. Observe left and right displays blank.
 - e. Key 1, 3, 2, 3, 0, 9, 5, 8, 3, 8, 4, 9 - Press.
 - f. **ENT** pushbutton - Press. Left, right, and center displays will momentarily blank and **TGT STR** number will appear. Displays should indicate 31T CF 09583849.

3.17.4.7 Entering Present Position or Destination Variation In LAT/LONG.

The variation of a destination must be entered after the associated destination coordinates are entered (since each time a destination is entered its associated variation is deleted). The order of entry for present position is irrelevant.

NOTE

If operation is to occur in a region with relatively constant variation, the operator enters variation only for present position, and the computer will use this value throughout the flight.

1. **MODE** selector - **LAT/LONG**.
2. **DISPLAY** selector - **DEST-TGT**.
3. **DEST DISP** thumbwheel - P, numerical or H as desired.
4. Present position or destination - Enter. (Example: Entry of N41° 10.1 minutes and E035° 50.2 minutes.) Press **KYBD** pushbutton. Observe that display freezes and **TGT STR** indicator blanks. Press **KYBD** pushbutton again and observe left display blanks. Press keys 5, 5, 4, 1, 1, 0 and 1. Press **KYBD** pushbutton (right display should clear), and keys 2, 2, 0, 3, 5, 5, 0 and 2.
5. **ENT** pushbutton - Press. Entire display will blank and **TGT STR** number will reappear. Display should indicate N 41° 10.1 E0 35° 50.2.

3.17.4.8 Ground Speed and Track.

1. **MODE** selector - **BACK UP**.
2. **DISPLAY** selector - **GS-TK**.
3. Ground speed and track - Enter. (Example: Enter 131 km/h and 024°. Press **KYBD** pushbutton, observe that left display freezes and **TGT STR** indicator blanks. Press **KYBD** pushbutton and observe that left display blanks. Press keys 1, 3, and 1. Left display indicates 131. Press **KYBD** pushbutton, control shifts to right display, and right display blanks. Press keys 0, 2 and 4.
4. **ENT** pushbutton - Press. The entire display will blank, and **TGT STR** number will reappear. Display should indicate 131 024°.

3.17.4.9 Initial Data Entry. Initial data entry of variation in coordinates is normally done prior to takeoff. To make the initial data entry, do the following:

1. Present position variation - Enter (paragraph 3.17.4.5).

2. **DISPLAY** selector - **DEST-TGT**.
3. **DEST DISP** thumbwheel - P. Do not press **ENT** key now.
4. **ENT** pushbutton - Press as helicopter is sitting over or overflies initial fix position.
5. **FLY-TO DEST** thumbwheel - Desired destination location.

3.17.4.10 Update of Present Position From Stored Destination. The helicopter is flying to a destination set by the **FLY-TO DEST** thumbwheel. When the helicopter is over the destination, the computer updates the present position when the **KYBD** pushbutton is pressed, by using stored destination coordinates for the destination number shown in **FLY-TO DEST** window, and adding to them the distance traveled between the time the **KYBD** pushbutton was pressed and the **ENT** key was pressed.

1. **DISPLAY** selector - **DIST/BRG-TIME**.
2. **KYBD** pushbutton - Press, when helicopter is over the destination. Display freezes.

NOTE

If a present position update is not desired, as indicated by an appropriately small value of distance to go on overflying the destination, set the **DISPLAY** selector to some other position, this aborts the update mode.

3. **ENT** key - Press.

3.17.4.11 Update of Present Position from Landmark. There are two methods for updating present position from a landmark. Method 1 is useful if the landmark comes up unexpectedly and the operator needs time to determine the coordinates. Method 2 is used when a landmark update is anticipated.

- a. Method 1.

- (1) **DISPLAY** selector - **PP**.
- (2) **KYBD** pushbutton - Press as landmark is overflowed. Present position display will freeze.
- (3) Compare landmark coordinates with those on display.
- (4) Landmark coordinates - Enter. If difference warrants an update.

- (5) **ENT** key - Press if update is required.
 - (6) **DISPLAY** selector - Set to some other position to abort update.
- b. Method 2.
- (1) **DISPLAY** selector - **DEST/TGT**.
 - (2) **DEST DISP** thumbwheel - P. Present position coordinate should be displayed.
 - (3) **KYBD** pushbutton - Press, observe that display freezes.
 - (4) Landmark coordinates - Manually enter via keyboard.
 - (5) **ENT** key - Press when overflying landmark.
 - (6) **DISPLAY** selector - Set to some other position to abort update.

3.17.4.12 Left-Right Steering Signals. Flying shortest distance to destination from present position.

1. **DISPLAY** selector - **XTK-TKE**.
2. **MODE SEL** - **DPLR**.
3. Fly helicopter in direction of lateral deviation pointer on vertical situation indicator to center the pointer, or course deviation bar on HSI.

3.17.4.13 Target Store (TGT STR) Operation. Two methods may be used for target store operation. Method 1 is normally used when time is not available for preplanning a target store operation. Method 2 is used when time is available and it is desired to store a target in a specific **DEST DISP** position.

- a. Method 1.
- (1) **TGT STR** pushbutton - Press when flying over target.
 - (2) Present position is automatically stored and the destination location is that which was displayed in the target store indicator (position 6, 7, 8, or 9) immediately before pressing the **TGT STR** pushbutton.
- b. Method 2.

- (1) **MODE** selector - **UTM** or **LAT/LONG**, depending on coordinate format desired.
- (2) **DISPLAY** selector - **DEST-TGT**.
- (3) **DEST DISP** thumbwheel - P.
- (4) **KYBD** pushbutton - Press when over flying potential target. Display should freeze.

NOTE

Do not press **ENT** key while **DEST DISP** thumbwheel is at P.

- (5) If it is desired to store the target, turn **DEST DISP** thumbwheel to destination location desired and press **ENT** key.
- (6) If it is not desired to store the target, place **DISPLAY** selector momentarily to another position.

3.17.4.14 Transferring Stored Target Coordinates From One Location to Another. The following procedure allows the operator to transfer stored target coordinates from one thumbwheel location to another. For example, it is assumed that the pilot wants to put the coordinates of stored target 7 into location of destination 2.

NOTE

Throughout this procedure, range, time-to-go, bearing and left/right steering data are computed and displayed for the destination selected via the **FLY-TO DEST** thumbwheel.

1. **DISPLAY** selector - **DEST-TGT**.
2. **DEST DISP** thumbwheel - 7.
3. **KYBD** pushbutton - Press.
4. **DEST DISP** thumbwheel - 2.
5. **ENT** key - Press.

3.17.4.15 Transferring Variation From One Location to Another. The procedure to transfer variation data to the same location where the associated stored target coordinates has been transferred is the same as in paragraph 3.17.4.14. Transferring Stored Target Coordinates From One Location To Another, except that the **DISPLAY** selector is placed at **SPH-VAR**.

3.17.4.16 Dead Reckoning Navigation. As an alternate **BACKUP** mode, dead reckoning navigation can be done using ground speed and track angle estimates provided by the operator.

1. **MODE** selector - **BACKUP**.
2. **DISPLAY** selector - **GS-TK**.
3. Best estimate of ground speed and track angle - Enter via keyboard.
4. Set **MODE** selector to any other position to abort procedure.

3.17.4.17 Operation During and After Power Interruption. During a dc power interruption inflight, or when all helicopter power is removed, the random access memory (RAM) (stored destination and present position) data is retained by power from an 8.4 volt dc dry cell battery. This makes it unnecessary to reenter any navigational data when power returns or before each flight. If the battery does not retain the stored destination data during power interruption, the display will indicate on EN when power returns. This indicates to the pilot that previously stored data has been lost, and that present position, spheroid/variation, and destinations must be entered. The computer, upon return of power, resets present position variation to E000.0°, destination and associated variations to a non-entered state, remembers wind to zero and spheroid to CL6. The following data must be entered following battery failure:

1. Enter spheroid.
2. Enter present position variation.
3. Enter present position.
4. Enter each destination and its associated variation.

3.17.5 Stopping Procedure. **MODE** selector - **OFF**.

3.17A DOPPLER/GPS NAVIGATION SET (DGNS) AN/ASN-128B. UH

The AN/ASN-128B DGNS is an AN/ASN-128 LDNS with an embedded GPS receiver. The AN/ASN-128B in conjunction with the aircraft's heading, vertical references, and position and velocity updates from its internal GPS, provides accurate aircraft velocity, position and steering information from ground level to 10,000 feet. The system provides worldwide navigation, with position readout avail-

able in both Military Grid Reference System (MGRS) and Latitude and Longitude (LAT/LONG) coordinates. Navigation and steering is performed using LAT/LONG coordinates and a bilateral MGRS-LAT/LONG conversion routine is provided for MGRS operation. Up to 100 destinations may be entered in either format and not necessarily the same format.

3.17A.1 Antenna. The GPS antenna is located on the top aft section of the helicopter. The Doppler antenna is located below the copilot's seat (Figure 3-1).

3.17A.2 Controls, Displays, and Function. The control and displays for the AN/ASN-128B are on the front panel (Figure 3-18.1). The function of each control is as follows:

CONTROL/ INDICATOR	FUNCTION
	NOTE
	The MODE switch is locked in the OFF position and must be pulled out and turned to get into or out of the OFF position.
MODE selector	Selects mode of operation.
OFF	In this position the navigation set is inoperable: non-volatile RAM retains stored waypoint data.
LAMP TEST	Checks operation of all lamps.
TEST	Initiates built-in-self test exercise for the Doppler and GPS functions of the navigation set.
MGRS	Selects MGRS navigational mode of operation.
LAT/LONG	Selects latitude/longitude navigational mode of operation.
GPS LDG	Places navigation set in GPS landing mode of operation. This mode provides real time, tactical precision landing guidance information to the HSI and VSI indicators.
DISPLAY selector	Selects navigation data for display.

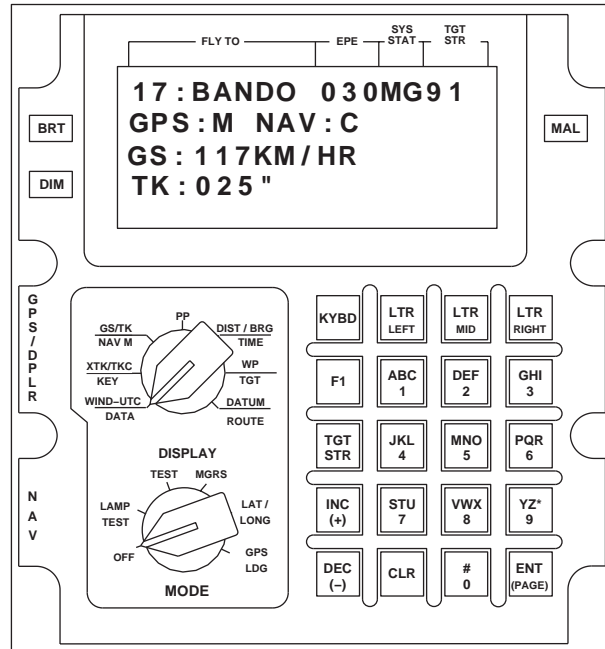

AA9998A
SA

Figure 3-18.1. Doppler/GPS Navigation Set AN/ASN-128B

**CONTROL/
INDICATOR**

FUNCTION

**WIND-UTC
DATA "Doppler
only"**

Used for wind speed and direction (with TAS sensor installed), UTC time, sea current, surface wind, GPS status and data load functions.

**XTK/TKE
KEY**

Displays steering (cross track distance and track angle error) information and GPS variable key status. Selection of fly to destination by direct entry of two digit destination number.

GS/TK NAV M

Displays ground speed, track angle and selection of **GPS** and navigation mode.

PP

Displays present position, altitude and magnetic variation.

**CONTROL/
INDICATOR**

FUNCTION

**DIST BRG
TIME**

Displays distance, bearing and time information to the destination or course selected. Selection of fly to destination can be accomplished by direct entry of two digit destination number.

WP TGT

Accesses waypoint or target data (landing data, variation, motion). Selection of destination for display/entry by direct entry of two digit destination number.

**DATUM
ROUTE**

Accesses datum and steering/route functions.

MAL indicator lamp

Lights when a malfunction is detected by the built-in-test circuitry. In the event of an intermittent malfunction, the system may operate correctly but must be cycled to the **OFF** position then to on, to extinguish the **MAL** light.

**CONTROL/
INDICATOR**

FUNCTION

BRT and DIM keys	Used to brighten or dim the light intensity of the LCD display.
Four line alpha-numeric display	Displays alphanumeric characters, as determined by the setting of the DISPLAY selector, the MODE selector and operation keyboard. The keys activate function upon pressing the key.
TGT STR key	Stores present position data in the indicated target store/memory location (90-99) when pressed.
KYBD key	Used in conjunction with the keyboard to allow data display and entry into the computer.
Keyboard and LTR keys	Used to set up data for entry into memory. When DISPLAY selector is set to a position in which new data is required and KYBD key is pressed, data may be displayed on the appropriate input field of display. To display a number, press the corresponding key or keys (0-9). To display a letter, first press the LTR key corresponding to the position of the desired letter on a key. Then press the key which contains the desired letter. Example: To enter an L , first press the LTR RIGHT key, then press key 4.

**CONTROL/
INDICATOR**

FUNCTION

INC and DEC keys	Used to increment or decrement the displayed waypoint/target number when the DISPLAY selector is set to WP/TGT . To access P , press the LTR LEFT key followed by key 6; display waypoint 99 then press the INC key; or display waypoint 00 then press the DEC key. Also used to increment or decrement the fly-to destination number when the DISPLAY selector is set to DIST/BRG/TIME or XTK/TKE/KEY .
ENT key (PAGE)	Enters data into memory (as set up on keyboard and displayed). This key is also used for paging of displays. The bottom right corner of the display indicates "more" when additional pages are available, and "end" when no additional pages are available. Pressing this key when "end" is displayed will return the display to the first page.
CLR key	Clears last entered character when pressed once. When pressed twice, clears entire input field of display keyboard control.
F1 key	Reserved for future growth.

3.17A.3 Modes of Operation. Control of the Doppler/GPS, including selection of modes and displays, and entry and readout of data is performed via the Computer Display Unit (CDU) front panel. The system has four basic modes of operation: **OFF**, navigate, **TEST** and **GPS LDG**. In the navigate mode three submodes may be selected manually or automatically. These are combined mode (default or primary mode of operation), GPS only mode, or Doppler only mode.

3.17A.3.1 OFF Mode. In the **OFF** mode the system is inoperable. However, the edge lighting is lighted by an external aircraft power source and is independent of the Doppler/GPS **MODE** selector setting. Edge lighting may not be available if the helicopter is modified with the night vision MWO.

3.17A.3.2 Navigate Mode. In the navigate mode (**MGRS** or **LAT/LONG**) position of the CDU **MODE** selector) power is applied to all system components, and all required outputs and functions are provided. The Doppler radar velocity sensor (DRVS) measures aircraft velocity, and converts analog heading, pitch and roll into digital form. This data and embedded GPS receiver (EGR) velocity and position data are then sent to the CDU for processing. Barometric altitude is used for aiding the GPS when only three satellites are available. Four satellites are required if the barometric altitude sensor is not available. Present position is computed by using one of three navigation submodes which can be selected manually or automatically. These submodes are as follows:

3.17A.3.2.1 Combined Mode (Default or Primary Mode of Operation). Doppler and GPS position and velocity data are combined to provide navigation. This mode is used when a minimum of three (with barometric sensor) or four satellites are available, GPS Estimated Position Error (EPE) is less than approximately 150 meters, and the Doppler is not in memory. If GPS becomes invalid (e.g. due to increased EPE), the system will automatically switch to Doppler mode until a valid GPS status is received. The **GPS POS ALERT** advisory light will illuminate when this happens. If the Doppler becomes invalid (e.g. flight over glassy smooth water), the system will automatically switch to GPS mode if GPS is valid or an alternate Doppler mode if the GPS is not valid.

3.17A.3.2.2 GPS Mode. GPS positions and velocities are used for navigation by the Doppler navigation processor in the CDU. If GPS mode is selected and the GPS becomes invalid (paragraph 3.17A.3.2.1), the system will not navigate. The **GPS POS ALERT** advisory light indicates that GPS signals are not reliable.

3.17A.3.2.3 Doppler Mode. Doppler position and velocity data are used for navigation. If Doppler mode is selected and the Doppler becomes invalid (paragraph 3.17A.3.2.1), the system will automatically switch to True Air Speed (TAS) mode (using remembered wind) if a TAS sensor is available, or remembered velocity if a TAS sensor is not available. If Doppler mode is manually selected at the start of the flight an initial present position must be obtained and entered prior to flight. Navigation is performed in latitude/longitude for computational convenience only. At the same time, distance, bearing and time-to-go to any one of 100 preset destinations are computed (as selected by **FLY-TO-DEST**).

3.17A.3.3 Test Mode. The **TEST** mode contains two functions: **LAMP TEST** mode, in which all display segments are lit, and **TEST** mode, in which system operation is verified. In the **LAMP TEST** mode, system operation is identical to that of the navigate mode except that all lamp segments and the **MEM** and **MAL** indicator lamps are lighted to verify their operation. In **TEST**, the RTA no longer transmits or receives electromagnetic energy; instead, self-generated test signals are inserted into the electronics to verify operation of the DRVS. At this time a self test is performed by the GPS and navigation computations continue using remembered velocity. In the **TEST** mode, Doppler test results are displayed on the CDU front panel for the first 15 seconds (approximate). At the end of this period either **GO** is displayed if there is no malfunction in the navigation set, or a failure code is displayed if a malfunction has occurred. A rotating bar on the display indicates that the GPS has not completed self test. If the navigation set is maintained in the **TEST** mode, no navigation data can be displayed on the CDU front panel. If a Doppler malfunction is detected, the **MAL** indicator lamp lights and **DF** is displayed. At the completion of GPS self test (up to two minutes), the rotating bar is replaced with a complete test result code. The failed unit and the failed circuit card are also indicated by a code on the CDU display. The CDU is continuously monitored for failures, using its own computer as built-in-test-equipment (BITE). Any BITE malfunction causes the **MAL** indicator lamp on the CDU to light. If the **MODE** selector on the CDU is set to **TEST**, identification of the failed LRU is indicated by a code on the display panel. Aircraft heading, pitch and roll are also displayed in the mode by pressing the **ENT** key after Doppler test is completed. GPS test status is displayed if the **ENT** key is pressed a second time. Malfunction codes are automatically latched and can only be cleared by recycling the CDU power via the CDU mode switch (**OFF-ON**).

3.17A.3.4 GPS Landing Mode. In the **GPS LDG** mode, the Doppler navigation system provides information

to the HSI and VSI indicators for real time landing guidance to a touch down point previously entered in any of the 100 fly-to destinations. The landing approach is determined by present position and the entered touch down altitude, glideslope and inbound approach course.

3.17A.4 CDU Operation. Various required operating data, such as initial present position (if GPS is not valid or Doppler mode is selected), destination coordinates with or without GPS landing data, and magnetic variation can at any time be entered into the CDU via its keyboard, or the data loader (Figure 3-11) via the preprogrammed data loader cartridge. In most cases, these data will be entered before the aircraft takes off. The GPS provides present position to the Doppler/GPS. If GPS is not available or Doppler is selected present position can be initialized as follows:

1. The **MODE** selector should be set to **MGRS** or **LAT/LONG**, the **WP/TGT** display position of the **DISPLAY** selector is selected, the destination number is set to **P** (default waypoint) and **KYBD** key is pressed. The coordinates of the initial position is overflowed, the **ENT** key is pressed. The computer then determines changes from the initial position continuously, and the coordinates of the current present position can be read either by remaining in this configuration or by setting the **DISPLAY** selector to **PP** (present position) and the **MODE** selector to **MGRS** or **LAT/LONG**.
2. To update present position over a stored destination, **KYBD** key is pressed when the aircraft overflies this destination. If an update is desired, the **ENT** key is pressed and the update is completed. The **DISPLAY** selector is in the **DIST/BRG/TIME** position and the **FLY-TO-DEST** is set to this destination during this process. The distance-to-go, displayed while over the stored destination, is the position error of the system at that moment.
3. To update present position over a fixed point not previously stored in the computer, the **DISPLAY** selector is placed to **PP** and **KYBD** key is pressed as the fix point is overflowed. This freezes the display while allowing computation of changes in present position to continue within the computer. If an update is required the coordinates of the fix point are entered via the keyboard, and **ENT** key is pressed. The position change which occurred since over-flying the fix point is automatically added to the fix point coordinates to complete the position update.
4. Magnetic variation can be entered for each destination, and the system will compute present position magnetic variation. If operation is to occur in a region with relatively constant magnetic variation, the operator enters magnetic variation only for present position and the computer will use this value throughout the flight. If **MGRS** data are to be entered or displayed, the **MGRS** datum of operation is also entered.

3.17A.5 Target-of-Opportunity. Target-of-opportunity data can be stored by pressing **TGT STR** (target store) key when the target is overflowed. This operation stores the coordinates of the target in one of ten destination locations in the computer; locations 90-99 sequentially incrementing each time the **TGT STR** key is pressed. The location is displayed in the appropriate display field. The computer can keep track of individual target positions which may include speeds and directions input by the operator.

3.17A.6 Self Test. Self test of the AN/ASN-128B is accomplished using BITE with the **RTA**, **SDC**, and **CDU** units connected and energized for normal operation. Self test enables the unit to isolate failures to one of the four main functions (**RTA**, **SDC**, **CDU** or **EGR**) or to one of the circuit cards in the **SDC** or **CDU**. Self test is accomplished as follows:

1. The CDU (except for the keyboard and display) is checked on a continuous basis, and any failure is displayed by the illumination of the **MAL** indicator lamp on the CDU. If the **MODE** selector on the CDU is set to the **TEST** position, identification of the failed circuit card in the CDU is indicated by a code on the display panel.
2. The **DRVS** and **EGR** are tested by setting the **MODE** selector on the CDU to the **TEST** position. Failure of the **DRVS** or **EGR** are displayed on the CDU by illumination of the **MAL** indicator lamp, and identification of the failed unit or circuit card is indicated by a code on the display panel of the CDU.
3. Continuous monitoring of the signal data converter and receiver transmitter antenna is provided by the system status indication. The system will not use Doppler velocities in normal operation when flying over glassy smooth water. However, if the system continues to not use

Doppler (e.g. using GPS only when combined has been selected) for excessive periods of time (e.g. more than 10 minutes) over land or rough water, then a malfunction may exist in the navigation set and the operator should set the **MODE** selector to **TEST** to determine the nature of the failure.

4. The display portion of the CDU is tested by illuminating all the lamp segments in each alphanumeric character in the **LAMP TEST** mode.
5. Keyboard operation is verified by observing the alphanumeric characters as the keyboard is exercised.

3.17A.7 Route Sequencing Modes. The system has the ability to fly a preprogrammed sequence of waypoints. This sequence can be either consecutively numbered in which case a start and end waypoint are entered or random numbered, in which case all waypoints are put in a list and the start and end waypoints are entered. Both sequence modes can be flown in the order they are in the list or in the reverse order. Directions will be displayed to the waypoint next on the list until approximately 10 seconds before overflying the waypoint at which time the display will advance to the next waypoint and the new waypoint number will blink for ten seconds. One consecutive and one random sequence may be stored in the system.

3.17A.8 To-To Route Mode. The system has the ability to provide steering information onto a course defined by the start and end waypoints. Only the second waypoint will be overflown. The distance displayed is the distance to the course when outside two nautical miles of the course and the distance to the second waypoint when inside two nautical miles of the course.

3.17A.9 General Operating Procedures for Entering Data. The panel display consists of four line LCD readout. The top line of the display is reserved for the display of Fly-To destination number and destination name/International Civil Aeronautic Organization (ICAO) identifier, EPE in meters, mode of GPS and mode of AN/ASN-128B operation and target store number. The remaining lines will display data in accordance with the **DISPLAY** and **MODE** selectors. When pressing the **KYBD** key for the first time in an entry procedure, the display freezes, **kybd** is displayed in the bottom right corner indicating the display is in the keyboard mode and the input field under keyboard control blinks. If it is not desired to change the display field under control, the pilot can advance to the next field of the display by pressing the **KYBD** key again. Press-

ing the **ENT** key (whether or not new data has been entered) causes the display to blank momentarily and return with the latest computed data. To abort a keyboard operation, move the **MODE** or **DISPLAY** selector to another position.

a. Data Entry. To display a letter, first press the **LTR** key corresponding to the position of the desired letter on a key. Then press the key which contains the desired letter. For example, to enter an **L**, first press the **LTR RIGHT** key, then press key **4**.

b. Keyboard Correction Capability. The last character entered may be cleared by pressing the **CLR** key. If the **CLR** key is pressed twice in succession, the field is cleared but remains under control (indicated by blinking) and the last valid data entered is displayed.

c. Destination Variation Constraint. The magnetic variation associated with a destination must be entered after the coordinates for that destination are entered. The order of entry for present position is irrelevant.

d. Impossibility of Entering Unacceptable Data. In most cases the computer program will reject unacceptable data (for example, a **MGRS** area of **W1** does not exist and will be rejected). If the operator attempts to insert unacceptable data, the unacceptable data will be displayed on the panel and then the selected field will blink after **ENT** key is pressed displaying the last valid data.

NOTE

The computer cannot prevent insertion of erroneous data resulting, for example, from human or map errors.

e. Procedure for Displaying Wind Speed and Direction. (TAS Sensor Required)

NOTE

In **MGRS** mode, wind speed is displayed in km/hr; in **LAT/LONG** mode, wind speed is displayed in knots. Wind direction is defined as the direction from which the wind originates.

- (1) Set **MODE** selector to **LAT/LONG** (**MGRS** may also be used).
- (2) Set **DISPLAY** selector to **WIND-UTC (coordinated universal time)/DATA** and observe display.

(3) The display indicates:

SP:XXXXn

DIR:XXX°

f. Procedure for displaying/entering UTC and displaying GPS status.

- (1) Set **MODE** selector to **LAT/LONG** (**MGRS** may also be used).
- (2) Set **DISPLAY** selector to **WIND-UTC/DATA** and observe the wind speed/direction display.
- (3) Press **ENT** key. Observe that the CDU display indicates year ** (default year is 93), day **317** and indicates hours, minutes, and seconds of UTC time: 09 Hours, 25 Minutes, 10 Seconds.
- (4) To enter year, day and time press the **KYBD** key to select the field for input shown as a blinking field, enter the desired data and press the **ENT** key.
- (5) To display GPS status press the **ENT** key to display selection menu.

1>SEA CURRENT

2>SURFACE WIND

3>GPS STATUS

4>DATA LOAD end

- (6) To select the **GPS STATUS** page press key **3**.
- (7) Observe the CDU display. The display indicated the GPS test mode status as of one of the following:

GPS TEST: IN PROCESS

GPS TEST: NOT RUN

GPS TEST: PASSED

GPS TEST: FAILED

g. Procedure for displaying **GPS** key and GPS satellite status.

- (1) Set the **DISPLAY** selector to **XTK/TKE/KEY**.

(2) Set the **MODE** selector to **LAT/LONG** (**MGRS** may also be used).

(3) The display indicates GPS daily key status, time remaining on the currently entered keys and how many satellites are currently being used by the GPS.

KEY	STATUS	TIME	REMARKS
DK	OK	Days or hours still available on key	GPS daily key in use and verified
DK	NO	*	No GPS daily key available
DK	IN	*	GPS daily key available but not verified

3.17A.10. Preflight Procedures.

a. Data required prior to DGNS turn-on.

- (1) The following initial data must be entered by the pilot after system turn-on and initialization, unless previously entered data is satisfactory:
- (2) Datums of operation, when using **MGRS** coordinates. This data may be part of the data load if preprogrammed.
- (3) In combined or GPS mode the GPS provides preset position. If the Doppler only mode is selected **MGRS** coordinates of present position - zone area, easting and northing; latitude/longitude coordinates may also be used to input present position. This data may be part of the data load if preprogrammed. Variation of present position to the nearest one-tenth of a degree.
- (4) Coordinates of desired destinations 00-99. It is not necessary to enter all destinations in the same coordinate system. This data may be part of the data load if preprogrammed. Destination locations of 70 through 89 are only programmable through the data loader.
- (5) Variation of destinations to the nearest one-tenth of a degree.

- (6) Crypto-key variables necessary to enable the GPS receiver to operate in **Y** code are entered via remote fill data only and not via the CDU keyboard.

NOTE

Destinations are entered manually when steering information is required to a destination that was not in the set of data loaded via the data loader, or it is desired to update present position by overflying a destination, or a present position variation computation is desired. (See CDU operation). If a present position variation update is desired, destination variation must be entered. The operator may enter one or more destination variations; it is not necessary for all destinations to have associated variations entered and also not necessary to enter all destinations in any case, but variations must be entered after destination coordinates are entered.

- (7) The Doppler outputs true heading and accepts magnetic heading from gyromagnetic heading reference. If accurate magnetic variations are not applied, then navigation accuracy will be affected.

b. System Initialization.

- (1) Enter GPS mode "**M**".

NOTE

Select GPS mode "**M**" during initialization. If "**Y**" mode is selected before crypto-key variables are loaded the system will lock-up. System must be turned off, then back on.

- (2) Perform self test.
- (3) Perform download of data loader cartridge if necessary, or manually enter datum, destinations, magnetic variations, and present position.
- (4) Load crypto-key variables (unless previously loaded and still valid) necessary for operation of the GPS in **Y** mode.

NOTE

It is necessary to wait at least 12 minutes for key validation when new keys have been en-

tered, or collection of almanac data when set has no previous almanac data. During this time the GPS operation mode must be **M** and uninterrupted. After this time the GPS operating mode may be switched to **Y**. Observe the GPS key status and number of satellite vehicles (SVs) tracked after switching to **Y** mode. If the SV number goes to zero, repeat this procedure. The key status shall switch from **DK IN** to **DK OK** sometime during the 12 minutes.

- (5) Check datum of operation, if **MGRS** is being used.
- (6) Check destinations in **MGRS** or **LAT/LONG** coordinates as desired.
- (7) Check associated destination variations as desired. Remove all incorrect variations by setting **DISPLAY** selector to **WP/TGT**, setting the destination number to appropriate destination, and pressing the **KYBD** key and **ENT** key in that order. Variations of at least two destinations must be entered for automatic variation update computation to be performed. For accurate navigation it is advised to enter variations after each destination unless the variations are the same.
- (8) Select DGNS operating mode.

NOTE

The set will automatically select combined mode (default or primary operating mode) as this allows the system to select the best possible navigation method available.

- (9) Set the **FLY-TO-DEST** to the desired destination location.

c. Procedure for downloading data from data-loader cartridge (Figure 3-11).

- (1) Set the CDU **MODE** selector to **OFF**.
- (2) Insert the preprogrammed data loader cartridge.
- (3) Set the CDU **MODE** selector to **MGRS** (**LAT/LONG** may be used). Enter desired GPS code (**M** or **Y**) mode of operation.

- (4) Set the **DISPLAY** selector to **WIND-UTC/DATA**.
- (5) To display the select menu press the **ENT** key twice.

1>SEA CURRENT
 2>SURFACE WIND
 3>GPS STATUS
 4>DATA LOAD end

- (6) To select the **DATA LOADER** page press key 4.

DATA LOADER

ENTER DATA: N end

- (7) To begin the download press the **KYBD** and enter **Y** (yes).
- (8) Observe the CDU display. The CDU shall display **DOWNLOAD WAYPTS IN PROCESS**. If a transmission error occurs the CDU display shall change to **ERROR-RETRYING**.
- (9) When the transmission is complete the CDU shall display **DOWNLOAD WAYPTS COMPLETE**. If this display is not obtained within one minute of beginning the download check the data programming and connections.

- (10) Set the CDU **MODE** selector to **OFF**, remove the data loader cartridge if desired, and then set the CDU **MODE** selector to the desired setting.

d. Self-Test.

- (1) Set the **MODE** selector to **LAMP TEST**. Enter **GPS** mode "M " or "Y ". Verify the following:
 - (a) All edge lighting is illuminated.
 - (b) The **MAL** lamp is illuminated.
 - (c) All keyboard keys are lit.
- (2) Set the **MODE** selector to **TEST**. After Doppler and/or GPS self tests have completed (approximately 15 seconds for Doppler, up to 2 minutes for GPS), one of the following displays will be observed in the left and right displays:

NOTE

In the event the **TEST** mode display is not **GO ALL** the system should be recycled through **OFF** to verify the failure is to a momentary one.

- (3) Press the **BRT** pushbutton at least 10 times, then press the **DIM** pushbutton at least 10 times, then press the **BRT** pushbutton at least 10 times. LCD display shall alternately glow bright, extinguish, and glow bright.

LEFT DISPLAY	RIGHT DISPLAY	REMARKS
GO		Doppler has completed BIT and is operating satisfactorily, GPS is still performing BIT (GPS has a two minute BIT cycle maximum). Note that a rotating bar in the display indicates that the GPS is still performing self test.
GO	ALL	The entire system has completed BIT and is operating satisfactorily.

(Cont)

LEFT DISPLAY	RIGHT DISPLAY	REMARKS
GO	P	Pitch or Roll data is missing or exceeds 90°. In this case, pitch and roll in the computer are both set to zero and navigation in the Doppler mode continues with degraded operation. Problem may be in the vertical gyro or aircraft cabling.
NG	C, R, S, or H followed by a numeric code	A failure has occurred in the computer display unit or the signal data converter power supply. The operator should not use the system.
DN	GPS failure code	GPS has failed but operator can use Doppler to perform all navigation.
DF	Doppler failure code	Doppler has failed. GPS is still performing self test.
GN	Doppler failure code	Doppler has failed but operator can use GPS to perform all navigation.
EN	Doppler failure code	SDC battery is discharged. Items stored in memory have been deleted.

e. Procedure for displaying or selecting **GPS M** or **Y** operating mode, Doppler, GPS or combined operation, and displaying groundspeed and track.

(1) Set **MODE** selector to **MGRS** position (**LAT/LONG** or **GPS LDG** position may also be used).

(2) Set **DISPLAY** selector to **GS/TK/NAV M**.

(3) The display indicates the current GPS and navigation mode on the top line:

(a) Selected fly to waypoint.

(b) EPE (GPS estimated position error in meters). An asterisk (*) in the character position of the EPE display indicates an EPE of greater than 999 or data unavailable.

(c) GPS mode of operation:

M for mixed **C/A** and **P/Y** code GPS reception.

Y for only **Y** code GPS reception.

(d) DGNS mode of operation:

C for combined Doppler and GPS.

D for Doppler only.

G for GPS only.

R for remembered velocities.

* for no navigation.

(e) Target destination where the present position will be stored next time **TGT/STR** is pressed.

NOTE

In **MGRS** mode, ground speed is displayed in km/hr; in **LAT/LONG** mode, ground speed is displayed in knots.

Only mode **C**, **G**, and **D** may be selected as the primary navigation mode. Modes **R** and * are automatic fall back modes used when both the Doppler and GPS are unavailable

(4) Selection of **GPS** mode of operation: As an example, consider selection of **Y** - only

mode. Press **KYBD** key two times. Observe that the **GPS** mode blinks. To enter **Y** (for **Y** mode) press key **LTR LEFT** followed by key **9**, or press key **9** only. A **Y** will be displayed. Press **ENT** key. The entire display will blank out for less than one second and the center display will now indicate: **Y**.

- (5) Selection of DGNS mode of operation. As an example, consider selection of **GPS** - only mode of operation. Press **KYBD** key. Observe that the DGNS mode blinks. To enter **G** (for **GPS** mode) press key **LTR LEFT** followed by key **3**, or press key **3** only. A **G** will be displayed. Press **ENT** key. The entire display will blank out for less than one second and the DGNS mode will now indicate: **G** (or * if **GPS** is not available).
- (6) Ground speed and ground track angle are displayed on lines 3 and 4.

f. Procedure for entering/displaying present position or one of the 100 possible destinations in **MGRS**. The DGNS has the capability to display 100 destinations (numbered 00-99).

100 destinations

-00 to 69	Standard waypoints.
-70 to 89	Data load only waypoints, observable but not changeable via CDU keyboard. Used for national airspace data such as VORs, NDBs, and intersections.
-90 to 99	Target store waypoints (usable as standard waypoints, but not as route sequencing waypoints).

As an example, consider display of destination number 25.

- (1) Enter datum as described in paragraph j. below.
- (2) Set **MODE** selector to **MGRS**.
- (3) Set **DISPLAY** selector to **WP/TGT**.
- (4) Notice the current destination number displayed. To display destination number 25

press the **INC** or **DEC** key, or press key **2** then **5**. This is a direct key entry action.

- (5) Observe that the current destination **MGRS** zone, area, and easting/northing coordinates are now displayed. The destination number 25 and location name/ICAO identifier also appears in the display.
- (6) Entry for destination coordinates and location name/ICAO identifier: As an example, consider entry of zone **18T**, area **WN**, easting 5000, northing 6000, and ICAO identifier **BANDO**.
- (7) To enter key board mode press the **KYBD** key. Observe "**kybd**" displayed in the bottom right corner of the display. (Destination number blinks.) Press **KYBD** again. (Zone field blinks.) To enter **18T** press keys **1, 8, LTR MID, 7**.
- (8) Press **KYBD**. (Area and northing/easting blinks.) To enter **WN5000 6000** press keys **LTR MID, 8, LTR MID, 5, KYBD, 5, 0, 0, 0, 6, 0, 0, 0**.
- (9) Press **KYBD**. (Location name/ICAO identifier blinks.) To enter **BANDO** press keys **LTR MID, 1, LTR LEFT, 1, LTR MID, 5, LTR LEFT, 2, LTR RIGHT, 5**.
- (10) To store the displayed information into the selected destination display position press the **ENT** key.

NOTE

To access **P**, press the **LTR LEFT** key followed by key **6**. Another way to access **P** is to display waypoint **99** then press the **INC** key or display waypoint **00** then press the **DEC** key.

Waypoints cannot be recalled by location name/ICAO identifier.

- g. Procedure for entering/displaying present position or one of the 100 possible destinations in **LAT/LONG**. The DGNS set has the capability to display 100 destinations (number 00-99).

100 destinations

- 00 to 69 Standard waypoints
- 70 to 89 Data load only waypoints, observable but not changeable via CDU keyboard. Used for National Airspace Data such as VORs, NDBs, and intersections.
- 90 to 99 Target store waypoints (Usable as standard waypoints, but not as route sequencing waypoints).

As an example, consider display of destination number 25.

- (1) Enter the datum as described in paragraph j. below.
- (2) Set **MODE** selector to **LAT/LONG**.
- (3) Set **DISPLAY** selector to **WP/TGT**.
- (4) Notice that the current destination number is displayed. To display destination number 25 press the **INC** or **DEC** key, or press key 2 then 5. This is a direct key entry action.
- (5) Observe that the current latitude and longitude coordinates are now displayed. The destination number 25 and location name/ICAO identifier appears in the display.
- (6) Entry of destination coordinates and location name/ICAO identifier: As an example, consider entry of Latitude N41° 10.13 minutes and longitude E035° 50.27 minutes and ICAO identifier BANDO.
- (7) To enter keyboard mode press **KYBD** key. Observe "kybd" display in the bottom right corner of the display. (Destination number blinks.) Press **KYBD** again. (Latitude field blinks.) To enter N41° 10.13 press keys **N, 4, 1, 1, 0, 1, 3**.
- (8) Press **KYBD**. (Longitude field blinks.) To enter E035° 50.27 press keys **E, 0, 3, 5, 5, 0, 2, 7**.
- (9) Press **KYBD**. (Location name/ICAO identifier blinks.) To enter BANDO press keys **LTR MID, 1, LTR LEFT, 1, LTR MID, 5, LTR LEFT, 2, LTR RIGHT, 5**.

- (10) To store the displayed information into the selected destination display position press the **ENT** key. Display indicates:
N41° 10.13
E035° 50.27.

NOTE

To access **P**, press the **LTR LEFT** key followed by key 6. Another way to access **P** is to display waypoint 99 then press the **INC** key or display waypoint 00 then press the **DEC** key.

Waypoints cannot be recalled by location name/ICAO identifier.

- h. Procedures for entering variation and landing mode data.
 - (1) Set **MODE** selector to **MGRS** position-altitude entered/displayed in meters (**LAT/LONG** may also be used-altitude entered/displayed in feet).
 - (2) Set **DISPLAY** selector to **WP/TGT** position.
 - (3) Select the waypoint number desired by directly entering the two digit target number or pressing the **INC/DEC** keys. Observe the waypoint number entered and position data.
 - (4) Press the **ENT** key and observe the waypoint number, variation and/or landing data if entered.
 - (5) To enter a magnetic variation and/or landing mode data press the **KYBD** key to select the field for entry and enter the desired data as shown in steps 6 through 10 below. To end the entry operation press the **ENT** key.
 - (6) Entry of variation: as an example, consider entry of a variation of E001.2. Press keys **E, 0, 0, 1** and **2**. The decimal point is inserted automatically. If no landing mode data is to be entered, press **ENT** to complete the operation. Display indicates: E001.2°.

NOTE

An asterisk appearing in the variation field indicates the variation is not entered. Variations may not be entered for waypoints containing target motion.

- (7) The bottom two lines indicate the MSL altitude, desired glideslope, and the desired inbound approach course (IAC) to the indicated destination. As an example, consider entry of a glideslope of 8° an IAC of 270°, and an altitude of 230 meters, for destination number **25**.
 - (8) Press the **KYBD** key to blink the altitude field. Press the **INC/+** key to enter a positive altitude, press keys **2, 3, 0** (the leading zeros may be omitted) for the altitude of 230 meters in the example.
 - (9) Press the **KYBD** key to blink the glide slope field. Enter glideslope. The maximum allowable glideslope is 9 degrees. In the example enter 8 for an eight degree glideslope.
 - (10) Press the **KYBD** key to blink the inbound approach course field. Enter a three digit inbound approach course angle. In the example enter **2, 7, 0** to enter a **270** degree inbound approach course. Press the **ENT** key to complete the operation.
- i. Procedures for entering target motion and direction. In **MGRS** mode, target speed is entered in km/hr; in **LAT/LONG** mode, target speed is entered in knots.
- (1) Set the **MODE** selector to **LAT/LONG** (**MGRS** may be used).
 - (2) Set the **DISPLAY** selector to **WP/TGT** and select the target number desired (00-69 or 90-99) by directly entering the two digit target number or **INC/DEC** keys. Observe the waypoint number entered and position data.

- (3) Press the **ENT** key and observe the waypoint number, variation and/or landing data if entered.
- (4) Press the **ENT** key and observe the target speed and direction page.
- (5) To select target speed press the **KYBD** key twice and enter the target speed. The maximum target speed that may be entered is 50 knots.
- (6) To select the target direction press the **KYBD** key and enter the target direction.
- (7) To end the entry operation press the **ENT** key. In the example target 93 has a speed of 18 knots and a bearing of 128 degrees. At the time the **ENT** key is pressed and released, the target position will begin to be updated as a function of time based on the speed and direction entered.

NOTE

To abort/cancel and entry of target motion, enter a target speed of 000 using the above procedure.

- j. Procedure for entering/displaying datum (Table 3-1.1) or clearing all waypoints.
 - (1) Set the **MODE** selector to **MGRS** position (**LAT/LONG** may also be used).
 - (2) Set the **DISPLAY** selector to **DATUM/ROUTE**.
 - (3) To select the datum field press the **KYBD** key.
 - (4) Entry of ellipsoid: as an example consider entry of **47**, the code of the **WGS 84** datum. Press keys **4** and **7**. Press the **ENT** key, the display shall show **DATUM: 47**.

NOTE

Entering a new datum number to a particular waypoint applies that datum to all waypoints and converts their coordinates accordingly. For example, assume that the datum for waypoint 22 is datum 47 and the datum for waypoint 23 is datum 25. The datum number must be changed from 47 to 25 prior to entering data for waypoint 23. This will change the displayed coordinates for waypoint 22 because they have been converted from datum 47 to datum 25. The actual ground position of waypoint 22 has not changed. Extreme care must be taken not to confuse these newly converted coordinates with those originally entered.

- (5) To clear all waypoints, variations, landing data and target motions, enter **RDW** for the datum.

k. Procedure for entering sea current speed and direction for water motion correction. (Required only if GPS is not available.)

NOTE

Not required or necessary when in combined or **GPS** mode. In **MGRS** mode, surface wind speed is entered in km/hr; in **LAT/LONG** mode, surface wind speed is entered in knots. Leading zeros must be entered. Wind direction is defined as the direction from which the wind originates.

- (1) Set **MODE** selector to **LAT/LONG** (**MGRS** may be used).
- (2) Set **DISPLAY** selector to **WIND-UTC/DATA** and observe the standard wind speed and direction display.
- (3) Press the **ENT** key twice to display the selection menu.

1>**SEA CURRENT**

2>**SURFACE WIND**

3>**GPS STATUS**

4>**DATA LOAD end**

- (4) Press the **1** key to select **SEA CURRENT**. The display indicates:

SEA CURRENT

SP:XXXXKn

DIR:XXX°

- (5) Entry of sea current speed and direction: as an example, consider the entry of 4 knots and 135 degrees. Press **KYBD** key. Observe that the speed field blinks.
- (6) To enter speed, press keys **0, 0** and **4**. The speed indicates **004Kn**. The maximum sea current speed that may be entered is 50 knots.
- (7) Press **KYBD** key. The direction display blinks.
- (8) To enter direction, press keys **1, 3**, and **5**. Direction indicates 135°.
- (9) Press **ENT** key. The display momentarily blinks and then reappears.

NOTE

To abort entry of sea current, enter a sea current speed of 000 using the above procedure.

Table 3-1.1. Datums (AN/ASN-128B)

ID	NAME	ELLIPSOID ID
01	Adindan	CD
02	ARC 1950	CD
03	Australian Geodetic 1966	AN
04	Bukit Rimpah	BR
05	Camp Area Astro	IN
06	Djakarta	BR
07	European 1950	IN
08	Geodetic Datum 1949	IN
09	Ghana	WE
10	Guam 1963	CC

Table 3-1.1. Datums (AN/ASN-128B) (Cont)

ID	NAME	ELLIPSOID ID
11	G. Segara	BR
12	G. Serindung	WE
13	Herat North	IN
14	Hjorsey 1955	IN
15	Hu-tzu-shan	IN
16	Indian	EA
17	Ireland 1965	AM
18	Kertau (Malayan Revised Triangulation)	EE
19	Liberia 1964	CD
20	USER ENTERED	--
21	Luzon	CC
22	Merchich	CD
23	Montjong Lowe	WE
24	Nigeria (Minna)	CD
25	North American 1927 (CONUS)	CC
26	North American (Alaska and Canada)	CC
27	Old Hawaiian, Maui	IN
28	Old Hawaiian, Oahu	IN
29	Old Hawaiian, Kauai	IN
30	Ordance Survey of Great Britain 1936	AA
31	Qornoq	IN
32	Sierra Leone 1960	WE
33	South American (Provisional 1956)	IN
34	South American (Corrego Alegre)	IN
35	South American (Campo Inchauspe)	IN
36	South American (Chua Astro)	IN

Table 3-1.1. Datums (AN/ASN-128B) (Cont)

ID	NAME	ELLIPSOID ID
37	South American (Yacare)	IN
38	Tananarive Observatory 1925	IN
39	Timbalai	EA
40	Tokyo	BR
41	Voirol	WE
42	Special Datum, Indian Special	EA
43	Special Datum, Luzon Special	CC
44	Special Datum, Tokyo Special	BR
45	Special Datum, WGS 84 Special	WE
46	WGS72	WD
47	WGS84	WE

1. Procedure for entering surface wind speed and direction for water motion correction.

(1) Set **MODE** selector to **LAT/LONG** (**MGRS** may also be used).

(2) Set **DISPLAY** selector to **WIND-UTC/DATA** and observe the wind speed/direction display. Display will not appear if TAS sensor is not installed.

(3) Press the **ENT** key twice to display the selection menu.

1>SEA CURRENT

2>SURFACE WIND

3>GPS STATUS

4>DATA LOAD end

(4) Press key **2** to select **SURFACE WIND**. The display indicates:

SURFACE WIND

SP:XXXXn

DIR:XXX°

- (5) Entry of wind speed and direction: as an example, consider the entry of 20 knots and 150 degrees. Press **KYBD** key. Observe that the wind speed field blinks.
- (6) To enter the speed, press keys **0**, **2**, and **0**. The wind speed indicates 020. The maximum surface wind speed is 50 knots.
- (7) Press **KYBD** key. The direction display blinks.
- (8) To enter direction, press keys **1**, **5**, and **0**. Wind direction indicates 150°.
- (9) Press **ENT** key. The display momentarily blinks and then reappears.

NOTE

To abort entry of surface wind speed and direction, enter a surface wind speed of 000 using the above procedure.

3.17A.11 Flight Procedures.

NOTE

This procedure is applicable to the Doppler only mode. Present position is automatically updated when DGNS is in combined mode.

- a. Updating present position from a stored destination.

NOTE

The preface is: The aircraft is flying to a destination. Destination is set to the number of the desired destination.

- (1) Set **DISPLAY** selector to **DIST/BRG/TIME** position. Distance, bearing and time-to-go to the fly-to destination are displayed.
- (2) When the aircraft is over the destination, press **KYBD** key. Observe that the display freezes.

- (3) Position update can be effected by pressing the **ENT** key. The computer updated the present position at the time the **KYBD** key was pressed by using the stored destination coordinates, and adding to them the distance traveled between the time the **KYBD** key was pressed and the **ENT** key was pressed. In addition, if an associated variation for the stored destination exists, the present position variation is also updated.
- (4) If a present position update is unnecessary (as indicated by an appropriately small value of **DISTANCE** to go on overflying the destination), set the **DISPLAY** selector to some other position - this action aborts the update mode.

- b. Updating present position from a landmark.

Method 1 (Unexpected update)

NOTE

There are two methods for updating present position from a landmark. Method 1 is particularly useful if the landmark comes up unexpectedly and the operator needs time to determine the coordinates. Method 2 is useful when a landmark update is anticipated.

- (1) Set **DISPLAY** selector to **PP** position.
- (2) Overfly landmark and press **KYBD** key. The present position display shall freeze.
- (3) Compare landmark coordinates with those on display.
- (4) If the difference warrants an update, enter the landmark coordinates by pressing the **KYBD** key to blink the field to be changed, enter coordinates, then press the **ENT** key. The computer updates the present position (from the time the **KYBD** key was pressed) to the landmark coordinates, and adds to the updated present position the distance traveled between the time the **KYBD** key was pressed and the **ENT** key was pressed.
- (5) If an update is not desired, set the **DISPLAY** selector to some other position. This action aborts the update mode.

Method 2 (Anticipated update)

- (1) Set **DISPLAY** selector to **WP/TGT** position.
- (2) Access **P** by pressing the **LTR LEFT** key followed by key **6**, entering destination 00 then pressing the **DEC** key, or entering destination 99 then pressing the **INC** key.
- (3) Press **KYBD** key. Observe that the display freezes.
- (4) Manually enter the landmark coordinates by pressing the **KYBD** key to blink the field to be changed and enter the coordinates.
- (5) When overflying landmark, press **ENT** key.
- (6) If an update is not desired, set the **DISPLAY** selector to some other position. This action aborts the update mode.

- (3) To display Fly-To destination 43 press the **INC** or **DEC** key, or press key **4** then **3**. This is a direct key entry action.

Left-Right Steering Signals

- c. There are two methods the pilot may use to fly-to destination, using left-right steering signals displayed on the computer-display unit. Left-right steering signals may be used when flying the shortest distance to destination from present position (Method 1) or when flying a ground track from start of leg to destination (Method 2).

Method 1

When flying shortest distance to destination from present position, set **DISPLAY** selector to **DIST/BRG/TIME** position and steer vehicle to bearing displayed. If the display indicates a **L** (left) **TKE**, the aircraft must be flown to the left to zero the error and fly directly to the destination.

Method 2

When flying a ground track, set **DISPLAY** selector to **XTK/TKE** position. Steer vehicle to obtain zero for crosstrack error (**XTK**). If **XTK** is left (**L**), aircraft is to right of the desired course and must be flown to the left to regain the initial course. Select the course deviation bar by pressing, then releasing the **DPLR GPS** lens on the **HSI MODE SEL** panel.

3.17A.12 Fly-To Destination Operation.

- a. Initialization of Desired Course. When a fly-to destination is selected such as at the start of a leg, the present position at the time is stored in the computer. A course is then computed between the selected point and the destination. If the aircraft deviates from this desired course, the lateral offset or crosstrack distance error is computed. Distance and bearing to destination, actual track angle, and track angle error correction are computed from resent position to destination. See Figure 3-18.2 for a graphic definition of these terms.
- b. Procedure for selecting one of 100 possible Fly-To destinations (Direct/Default Mode). The Doppler/GPS navigation set has the capability of selecting a fly-to destination from 100 destinations (number 00-99). As an example, consider selecting Fly-To destination number 43.
 - (1) Set **MODE** selector to **MGRS (LAT/LONG** or **GPS LDG** may also be used).
 - (2) Set **DISPLAY** selector to **XTK/TKE**. Observe standard crosstrack (**XTK**) and track angle error (**TKE**) display. (**DIST/BRG/TIME** may also be used).

- d. Procedure to enter route-sequence to-to mode. The Doppler/GPS navigation set has the capability to navigate a course set up between two destinations. As an example, consider navigating onto a course starting from destination number 62 and ending at destination number 45.

- (1) Set **MODE** selector to **MGRS (LAT/LONG** may also be used).
- (2) Set **DISPLAY** selector to **DATUM/ROUTE**.
- (3) Press the **ENT** key. Observe that a menu of special steering functions appears.

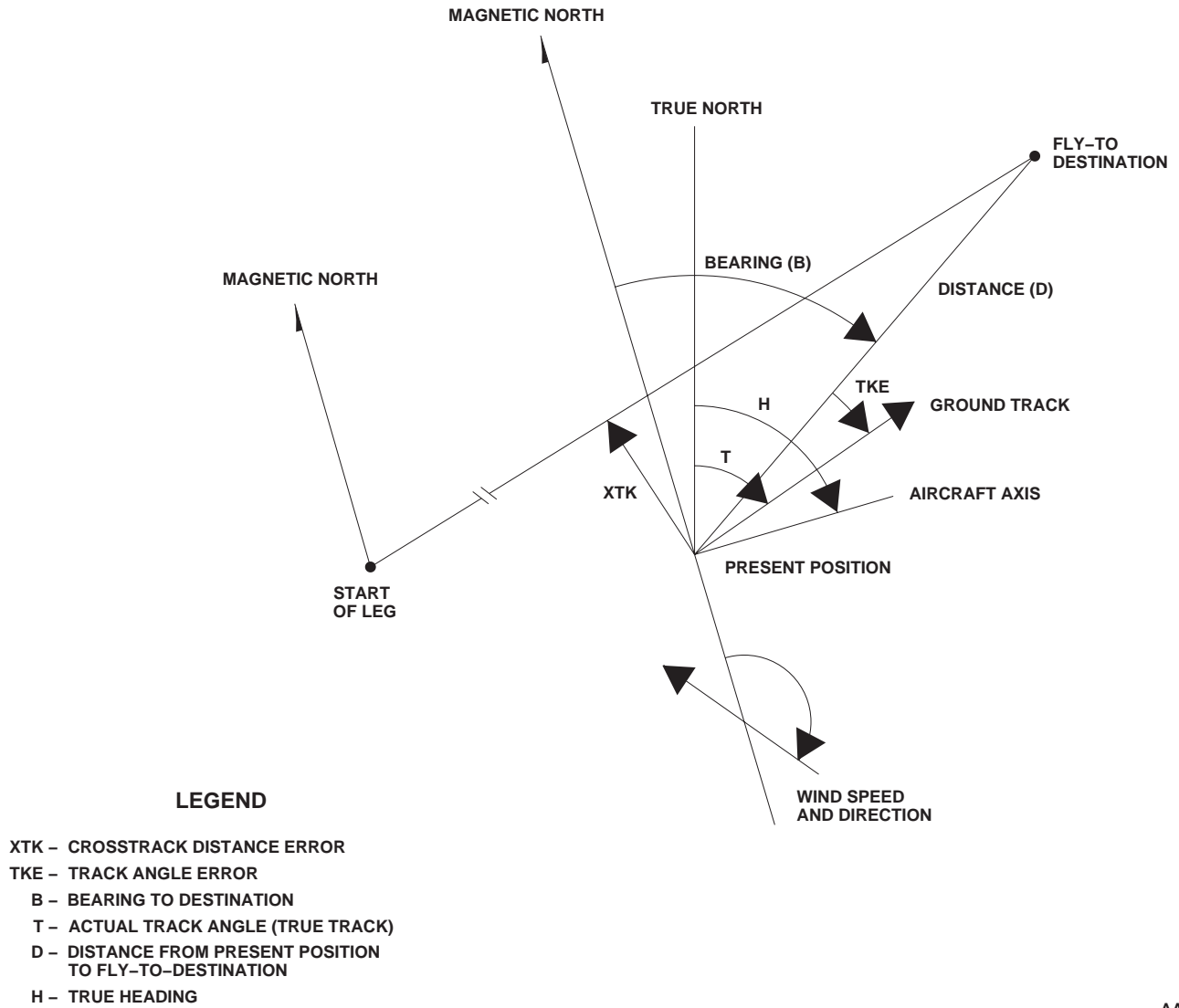

AA9999
SA

Figure 3-18.2. Definition of Course Terms

1>TO-TO
2>RANDOM
3>CONSEC
END

(4) To select the route-sequence to-to display press key 1. Observe that **TO-TO** and selection mode appears in the display. The display provides entry of starting and ending destination numbers.

- (5) To enter keyboard mode press the **KYBD** key. (**START** field blinks.) To enter starting destination 62 press keys **6, 2**.
- (6) Press **KYBD** key. (**END** field blinks.) To enter ending destination 45 press keys **4, 5**.
- (7) Press **KYBD** key. (**SELECT** field blinks.) Enter **Y** (yes) for mode selection. **N** (Default mode) may be entered to arm the system with the start and end destinations but without entering the route-sequence to-to mode, or to exit the Route-sequence to-to

mode if the system is currently in that mode. Then press the **ENT** key.

NOTE

There must be valid waypoint data to select a waypoint as a starting or ending waypoint. If not, upon pressing the **ENT** key, the invalid waypoint number will blink.

If an entry is changed after **Y** is entered for selection, an **N** must be entered for the selection then it may be changed to **Y**. The sequences must be flown from the beginning waypoint. The route cannot be flown in reverse (**R**).

No target destination or destination with target motion may be included as to-to waypoints.

If the **MODE** switch is placed to the **GPS LDG** position when **TO-TO**, **RANDOM**, or **RT SEQ CONSEC** is selected, it will turn off the route sequencing mode and change it back to direct-to.

e. Procedure to enter route-sequence random mode. The Doppler/GPS navigation set has the capability to navigate through a sequence of random number destinations. As an example, consider navigating through destination numbers 32, 25, 74, 01, 48, 83, 35.

- (1) Set **MODE** selector to **MGRS (LAT/LONG)** may also be used).
- (2) Set **DISPLAY** selector to **DATUM/ROUTE**.
- (3) Press the **ENT** key. Observe that a menu of special steering functions appears.

1>**TO-TO**
 2>**RANDOM**
 3>**CONSEC**
END

- (4) To select the route-sequence random display press key **2**. Observe that **RT SEQ RANDOM** now appears in the display followed by the sequence of destination numbers and a continuation prompt.

- (5) Enter the sequence of destination numbers by pressing the **KYBD** key to enter keyboard mode. (First destination field blinks.) To enter destination 32 press keys **3, 2**.
- (6) Press **KYBD** key. (Next destination field blinks.) Press keys **2, 5** to enter second destination 25.
- (7) Repeat step 6 until a maximum of ten destinations are entered or if less than ten need to be entered, asterisks are left for remaining destinations.
- (8) To complete the entry of the random sequence of waypoints press **ENT** key.
- (9) To select the start field and enter the starting destination press **KYBD** key.
- (10) To select the ending field and enter the ending destination press **KYBD** key.
- (11) Press **KYBD** key. (**SELECT** field blinks.) Enter **Y** (yes) for mode selection. **N** (default) may be entered to arm the system but without entering the route-sequence random mode, or to exit the Route-Sequence Random mode if the system is currently in that mode. An entry **Y** and **R** indicates a choice of **Y**- flying in forward order, or **R**-flying in reverse order. To clear the random sequence, enter a **C** for selection. Then press the **ENT** key.

NOTE

The sequence must be flown from the beginning waypoint.

No target destinations or destinations with target motion may be included as route sequence random waypoints.

If the **MODE** switch is placed to the **GPS LDG** position when **TO-TO**, **RANDOM**, or **RT SEQ CONSEC** is selected, it will turn off the route sequencing mode and change it back to direct-to.

- f. Procedure to enter route-sequence-consecutive mode. The Doppler/GPS navigation set has the capability to navigate through a sequence of

consecutively numbered destinations. As an example, consider navigating through destination numbers 32 through 35.

- (1) Set **MODE** selector to **MGRS (LAT/LONG)** may also be used).
- (2) Set **DISPLAY** selector to **DATUM/ROUTE**.
- (3) Press the **ENT** key. Observe that a menu of special steering functions appears.

```
1>TO-TO
2>RANDOM
3>CONSEC
  END
```

- (4) To select the route-sequence-consecutive display press key **3**. Observe that **RT SEQ CONSEC** now appears in the display, followed by the starting and ending destination numbers, and mode selection.
- (5) To enter keyboard mode, press the **KYBD** key. (**START** field blinks.) To enter destination 32 press keys **3, 2**.
- (6) Press **KYBD** key. (**END** field blinks.) Press keys **3, 5** to enter ending destination 35.
- (7) Press **KYBD** key. (**SELECT** field blinks.) Enter **Y** (yes) for mode selection. **N** (default mode) may be entered to arm the system but without entering the route-sequence-consecutive mode, or to exit the route-sequence-consecutive mode if the system is currently in that mode. An entry of **Y** and **R** indicates a choice of **Y**- flying in the forward order, or **R**- flying in reverse order.

NOTE

The sequence must be flown from the beginning waypoint.

No target destinations or destinations with target motion may be included as route sequence consecutive waypoints.

If the **MODE** switch is placed to the **GPS LDG** position when **TO-TO**, **RANDOM**, or

RT SEQ CONSEC is selected, it will turn off the route sequencing mode and change it back to direct-to.

- g. Procedure for displaying distance/bearing/time information.

- (1) Set **MODE** selector to **MGRS (LAT/LONG)** or **GPS LDG** may also be used).
- (2) Set **DISPLAY** selector to **DIST/BRG/TIME**.

- (3) Observe that the distance-to-go in kilometers (to the fly-to destination), bearing, and time-to-go appears on the bottom two lines of the display. (Distance is in nautical miles when **MODE** selector position is **LAT/LONG**.) Bearing-to-destination is displayed in degrees, and the time-to-go is displayed in hours, minutes, and tenths of a minute.

- (4) The display of the second line depends on the current steering mode as follows:

- (a) Direct-To steering (default): Fly-to destination number and ICAO identifier are displayed. Example: **58:BANDO**
- (b) To-To Steering: **TO-TO-:XX TO YY** where **XX** is the "To-To" start-of-leg destination number, and **YY** is the "To-To" fly-to destination number.

- (c) Route-sequence steering (both consecutive and random): **RT-RANDOM:XX TO YY** where **XX** is the current route-sequence fly-to destination number, and **YY** is the next destination number in the sequence. Approximately 10 seconds before overflying the fly-to destination, the system automatically 'pickles' to the next destination, and the new fly-to destination number blinks for 10 seconds then stops blinking.

- h. Procedure for displaying present position and GPS Altitude.

- (1) Set the **MODE** selector to **MGRS (LAT/LONG)** or **GPS LDG** may also be used). Set the **DISPLAY** selector to **PP** and observe present position display.

- (2) To display present position variation and GPS altitude press the **ENT** key. Present position variation may be entered by pressing the **KYBD** key to select the variation field. A variation is entered and the **ENT** key is pressed.

i. Target Store (**TGT STR**) Operation. Two methods may be used for target store operation. Method 1 is normally used when time is not available to preplan a target store operation. Method 2 is used when time is available and it is desired to store a target in a specific location.

Method 1 (uses location 90-99)

- (1) Press the **TGT STR** key while flying over target.
- (2) Present position and variation are automatically stored in the target destination location which was displayed in the target store field immediately prior to pressing the **TGT STR** key.

Method 2 (uses locations 00-69 and 90-99)

- (1) Set **MODE** selector to **MGRS** or **LAT/LONG** position, depending on coordinate from desired.
- (2) Set **DISPLAY** selector to **WP/TGT** position.
- (3) To access **P**, press the **LTR LEFT** key followed by key **6**. Another way to access **P**, is to display waypoint 99 then press the **INC** key or display waypoint 00 then press the **DEC** key.
- (4) Press **KYBD** key when overflying potential target. Observe that display freezes and **kybd** is displayed in the bottom right corner of the display indicating keyboard mode. The destination number is now under keyboard control indicated by a blinking field.

NOTE

Do not press **ENT** key while destination is set to P.

- (5) If it is desired to store the target, enter the two digit destination number and press the **ENT** key.

- (6) If it is not desired to store the target, set the **DISPLAY** selector momentarily or permanently to another position.

j. Procedure for entering landing mode.

- (1) Set the fly-to destination by setting the **DISPLAY** selector to either **XTK/TKE/KEY** or **DIST/BRG/TIME**. Directly enter the two digit destination number or use the **INC** or **DEC** keys.
- (2) Set **MODE** selector to **GPS LDG**.
- (3) The **DISPLAY** selector continues to function as before. To switch between metric and English units, press the **ENT** key.

NOTE

In this mode, the DGNS provides real-time landing guidance information to the HSI and VSI indicators. To display course deviation information on VSI and HSI, press then release the **DPLR GPS** button on the HSI/VSI **MODE SEL** panel.

k. Procedure for transferring stored destination/target data from one location to another. The following procedure allows the operator to transfer (copy) stored destination/target data from one destination/target location to another destination location. The transferred data consists of destination name/ICAO identifier, location, variation, and landing information. For illustrative purposes only, it is assumed that the operator wants to put the coordinates of stored target 97 into the location for destination 12.

- (1) Set **DISPLAY** selector to **WP/TGT** position.
- (2) Press key **9** then **7**.
- (3) Press **KYBD** key, press key **1** then **2**.

NOTE

Location name/ICAO identifier, variation, and landing data may be deleted by first displaying the waypoint, pressing the **KYBD** key, then the **ENT** key.

- (4) Press **ENT** key.

1. Operation during and after a power interruption. During a power interruption, the stored destination and target data and present position are retained by non-volatile RAM inside the CDU. This makes it unnecessary to reenter any navigation data when power returns. GPS satellite data are also retained by a battery inside the SDC. This makes it unnecessary to reload the crypto key or wait for the collection of any almanac. Navigation will be interrupted during the absence of power; however the present position will be updated when the GPS data becomes valid provided the DGNS mode has not been selected as Doppler only. The pilot will have to re-enter the GPS operating mode (**M** or **Y**) using a single key (**5** or **9**). In the event the CDU is initialized, the display will indicate only **EN** when the CDU is operated. This is an indication to the operator that previously stored data has been lost and that spheroid/variation, destinations, and calibration data must be entered. Present position needs to be entered only if Doppler only mode has been selected. The **KYBD** key must be pressed to clear the **EN**. The pilot will have to re-enter the GPS operating mode (**M** only) using single key (**5**). The computer initializes to the following: operating mode to combined, present position variation to E000.0, destinations and associated variations to a nonentered state, wind speed (water motion) and sea current speed to 000, spheroid to WGS 84 (WG-4), present position to N45° 00.00'E000°00.00' (until updated by GPS), target store location to 90, along track calibration correction to 00.0 percent, and magnetic compass deviation corrections to 000.0 degrees. The following data must be entered:

- (1) Press **KYBD** key.
- (2) Set **MODE** selector to **OFF** momentarily, to **LAMP TEST** for approximately one second, and then to **MGRS** or **LAT/LONG**.
- (3) Select **GPS M** or **Y** mode.
- (4) Select **DGNS** operating mode if other than combined.
- (5) Enter datum.
- (6) Enter present position if Doppler only has been selected.

- (7) Enter each destination and its associated variation.
- m. Procedure for displaying aircraft heading, pitch, and roll (Maintenance Function).
 - (1) Set the CDU mode switch to **TEST** and observe the CDU test mode display.
 - (2) After the Doppler test is completed press the **ENT** key.
 - (3) Observe the CDU display. The top three display lines indicate, in degrees and tenths of a degree, aircraft system heading, pitch, and roll.

3.18 INTEGRATED INERTIAL NAVIGATION SYSTEM (IINS) AN/ASN-132(V). EH

a. The IINS is a self-contained integrated navigation system capable of short and/or long-range missions which can be updated whenever TACAN navigational facilities exist or manually without TACAN data, and displays location of the helicopter on the control display unit (CDU). The IINS consists of the following equipment:

TYPE DESIGNATION	NAME	COMMON NAME
C-11097/ASN-132	Control Indicator	Control Display Unit
CV-3739/ASN-132	Converter, Signal Set	Signal Converter Unit (SDC)
AN/UYK-64(V)2	Data Processing Set	Navigation Processor Unit (NPU)
RT-1159/A	Receiver-Transmitter, Radio	TACAN RT
AN/ASN-141	Inertial Navigation Set	Inertial Navigation Unit (INU)
MT-4915/A	Mounting Base, Elect Equip	TACAN/SCU Mount

b. Auxiliary components of the IINS includes the **SYSTEMS SELECT** panel, INU blower assembly, INU battery assembly, and data bus couplers. The IINS provides

accurate indications of the helicopter navigation parameters including present position, velocity, altitude and heading information. The system employs a serial data bus for data interchange within the IINS and with external mission system computers. The IINS also interfaces with the helicopter flight instruments and altimeter encoder. The multiplex data bus system consisting of two buses (A and B), with only one bus active at any given time. The other bus is in a standby mode for redundancy purposes to provide a path for data flow between the Standard Inertial Navigation System (STD INS), Signal Converter Unit, Navigation Proces-

sor Unit, Control Display Unit, and the external mission systems. Data to and from the TACAN receiver-transmitter is first processed by the SCU before it is applied to the multiplex data bus.

3.19 CONTROLS, DISPLAYS, AND FUNCTION.

The IINS controls and displays (Figure 3-19) are contained on the CDU. The function of each control is as follows:

KEY	CONTROL OR INDICATOR	FUNCTION
1	Data display	Displays multiple flight parameters to the operator on seven data lines and a scratch pad line on the face of the cathode ray tube (CRT).
2	Line select keys	<p>On both sides of data display lines 1, 3, 5, and 7 are push-buttons (line select keys) which perform functions as defined by the legend adjacent to the key on the data display. If a line select key is active on a particular page, an arrow will appear in the character space closest to the key. Arrows will be oriented toward the legend, up, or toward the key (away from the legend). These orientations (with examples) are defined as follows:</p> <ol style="list-style-type: none"> 1. \blacktriangleright legend \blacktriangleleft (TH 358.3 \blacktriangleleft). If the arrow points toward the legend a numeric entry (entered into the scratch pad on line 8) is allowed by pressing the adjacent line select key. 2. \blacktriangleleft legend \blacktriangleright (MAG \blacktriangleright). If the arrow points away from the legend, pressing the adjacent line select key will initiate the function described by the legend. For example, pressing the line select key adjacent to "MAG \blacktriangleright" will change the display to MAG Heading (MH) and MAG VAR (MV). 3. \blacktriangleup legend \blacktriangledown (\blacktriangleup T/R). If the arrow points up, the legend indicates current mode status and pressing the adjacent line select key will change the mode. If no arrow appears next to a legend then that line select key performs no operation. 4. Up or down pointing arrows on the sixth line of the data display allows operator to slew display one page up or down by pressing page slew toggle switch up or down.
3	Alphanumeric keys	Alphanumeric entries are made, by pressing one of the ten character keys on the keyboard and will appear first in the scratch pad (line 8). Each actuation of a key will cause a character to be displayed from left to right in the scratch pad. When using multiple letter keys (e.g., KLM/5), letters K, L, or M can be entered into the scratch pad by successive actuations of the KLM/5 key. The 0-9 and. keys shall enter the respective number of decimal point unless the keyboard is in the letter mode. When the LTR/USE key is pressed, LTR is annunciated to the right of the scratch pad, and the next keystroke will enter an alpha character. When the desired data appears in the scratch pad, it will be entered by pressing the line select key adjacent to the data being updated. When the line select key is pressed, the scratch pad contents will be checked for proper range and format. If the entry is valid, it will be transferred to the IINS , read back, and displayed adjacent to the line select key. Completion of this cycle will clear the scratch pad.
4	CLR key	Used for erasing scratch pad parameters before entry. First actuation clears the last number or letter entered, second actuation clears the entire entry.

KEY	CONTROL OR INDICATOR	FUNCTION
5	BRT control	Controls brightness of the data display from full on to full off.
6	0 key	Used to enter number 0 into the scratch pad.
7	-/● key	Used to enter a minus symbol or decimal into the scratch pad. When pressed, ● will be entered into the scratch pad. When LTR/USE key is pressed, then -/● key is pressed, - will be entered into the scratch pad. To use the - in the scratch pad, the LTR/USE key must be pressed again.
8	LTR/USE key	When pressed, allows letters to be entered into the scratch pad. When pressed a second time, signals the CDU to use the character that was just entered, and deletes LTR entry mode.
9	FA CK key	When pressed, signals the system that an annunciated failure has been recognized by the operator, and causes the flashing annunciation to go to a steady annunciation.
10	Page select switch	Selects the type of information to be displayed. The following five categories of display pages can be selected:

NOTE

All CDU distance and speed displays in L/L mode are in nautical miles (NM). All distance and speed displays in **UTM** mode are in kilometers.

1. **POS.** Provides present position; universal transverse mercator (UTM) or latitude/longitude (L/L) selection; magnetic heading selection; magnetic variation; true or magnetic heading; ground track; and ground speed.

2. **INS.** Provides inertial alignment status; barometric pressure; altitude; data zeroize; and access to system data and unit tests.

3. **DEST.** Provides selected course entry; destination coordinates; UTM or L/L selection; range, bearing, and time to destination; cardinal heading/distance.

4. **STR.** Provides selected course; range, bearing and time to steerpoint; present position; UTM or L/L selection; cardinal heading/distance.

5. **TCN.** Provides both TACAN control and station data. The TACAN control page provides power control; mode selection; slant range and bearing to station; update enable; and access to station pages. The TACAN station pages provide station magnetic variation; coordinates, channel; slant range/bearing; and elevation.

11	Mode select switch	Selects eight different modes of operation for the IINS. The mode select switch selects the following IINS modes of operation:
----	--------------------	--

KEY	CONTROL OR INDICATOR	FUNCTION
	Mode select switch	<p>1. OFF. Turns off the IINS (removes power from TACAN RT, STD INS, and CDU).</p> <p>2. FAST. In this position the STD INS either performs a stored heading alignment or best available true heading (BATH) alignment. If a BATH alignment is performed, true or magnetic heading information must be entered not later than 1 minute after selecting the FAST mode. If magnetic heading information is not entered, system will assume a stored heading. After heading information is entered, present position may be entered if desired. FAST alignment is a degraded mode of operation and should not be used under normal conditions.</p> <p>3. NORM. In this position the STD INS performs a gyro-compass alignment. Present coordinates must be entered not later than 2 minutes after selecting the NORM mode.</p> <p>4. NAV. This is the STD INS primary flight mode of operation. NAV is entered after satisfactory alignment conditions have been met.</p> <p>5. UPDT. In this position the NPU freezes present position data for a later manual position update by overflying a known position designated by a mark.</p> <p>6. ATTD. In this position the STD INS initiates an attitude reference mode of operation. Although navigation processing is discontinued, the STD INS continues to provide a stable reference frame for generation of roll, pitch, and inertial heading angles.</p> <p>7. CAL. In this position the STD INS performs an automatic calibration of the gyro biases.</p> <p>8. TEST. In this position the STD INS performs functional performance tests, fault detection, and fault localization checks.</p>
12	DEST switch	Three position toggle switch used to increment/decrement selected destination. The number of the selected destination appears on line 1 of the data display. Up increases and down decreases the selected destination.
13	BIT indicator	Used to indicate the results of all internal CDU tests. White indicates a failure and black indicates test passed.
14	STR switch	Three position toggle switch used to increment/decrement selected steer point. The number of the selected steerpoint appears on line 1 of the data display. Up increases and down decreases the steerpoint number.
15	MRK key	Used to signal the STD INS to note the current position and use it for one of two of the following purposes:

KEY	CONTROL OR INDICATOR	FUNCTION
	MRK key	1. Store as a markpoint (destination A thru F) when the mode select switch is in the NAV position.
		2. Store present position relative to selected destination for possible updating when mode select switch is in the UPDT position.
16	Page slew switch	Three position toggle switch used to slew data display one page up or down by pressing page slew switch up or down.

3.20 SIGNAL CONVERTER UNIT, CV-3739/ASN-132. EH

The SCU performs data processing to convert the TACAN RT Aeronautical Radio Incorporated (ARINC) inputs and outputs to corresponding serial data formats for transmission over the multiplex data buses to the NPU and CDU. The SCU can communicate via one of the two multiplex data buses. Although the SCU communicates over only one multiplex data bus at a time, it can monitor both buses continuously to determine over which bus valid data communications are taking place. Redundant portions of the SCU circuitry are isolated to ensure that a failure of one bus does not degrade performance of the remaining bus.

3.21 TACAN NAVIGATIONAL SET RECEIVER-TRANSMITTER, RT-1159/A. EH

The position error of an inertial navigation system increases with time, therefore, a position reference sensor is used to update the inertial data, and thereby bound the time-growing position error. The **IINS** derives position updates from the TACAN RT range and bearing measurements. The TACAN RT determines the relative bearing and range of the helicopter from a selected TACAN ground station. The TACAN RT operates within 390 nautical miles of a TACAN ground station. Since the TACAN system operating limit is line of sight, the actual operating range is dependent on helicopter altitude. The TACAN system operates on a selected channel from 252 available channels. The 252 channels are equally divided into 126 x-channels and 126 y-channels with both x- and y-channels spaced at 1 MHz intervals. Upon being interrogated by the TACAN RT, the ground station beacon transmits a signal. From the return signal, the TACAN RT computes bearing and distance values for updating the inertial system information. The TACAN RT outputs are processed by the SCU for compatibility with the multiplex data buses. The TACAN RT also produces and transmits distance information when interrogated in the air-to-air operation another TACAN equipped aircraft, however, this air-to-air mode precludes using the TACAN information to update the **IINS**.

3.22 SYSTEMS SELECT PANEL. EH

The **SYSTEMS SELECT** panel (Figure 3-20) consists of two switch light indicators, located on the center lower edge of the instrument panel. It provides a switching capability for utilization of **IINS** through a relay assembly. The **SYSTEMS SELECT** panel operates as follows:

HDG

DG: ASN-43 directional gyro output is displayed on the HSI's. ASN-43 interface with the VSI/HSI Mode Select System, the SAS/FPS flight computer, the civil navigation system, and the Command Instrument System (CIS).

IINS: **IINS** heading output is displayed on the HSI's. **IINS** interface with the above system, replacing the ASN-43.

ATT

VG: CN-1314 Pilot or copilot vertical displacement gyro output is displayed on respective VSI's and used by the SAS/FPS computer as determined by the VSI/HSI **MODE SEL VERT GYRO** setting.

IINS: **INU** output is displayed on the VSI's and is used by the SAS/FPS computer depending on the VSI/HSI **MODE SEL VERT GYRO** setting.

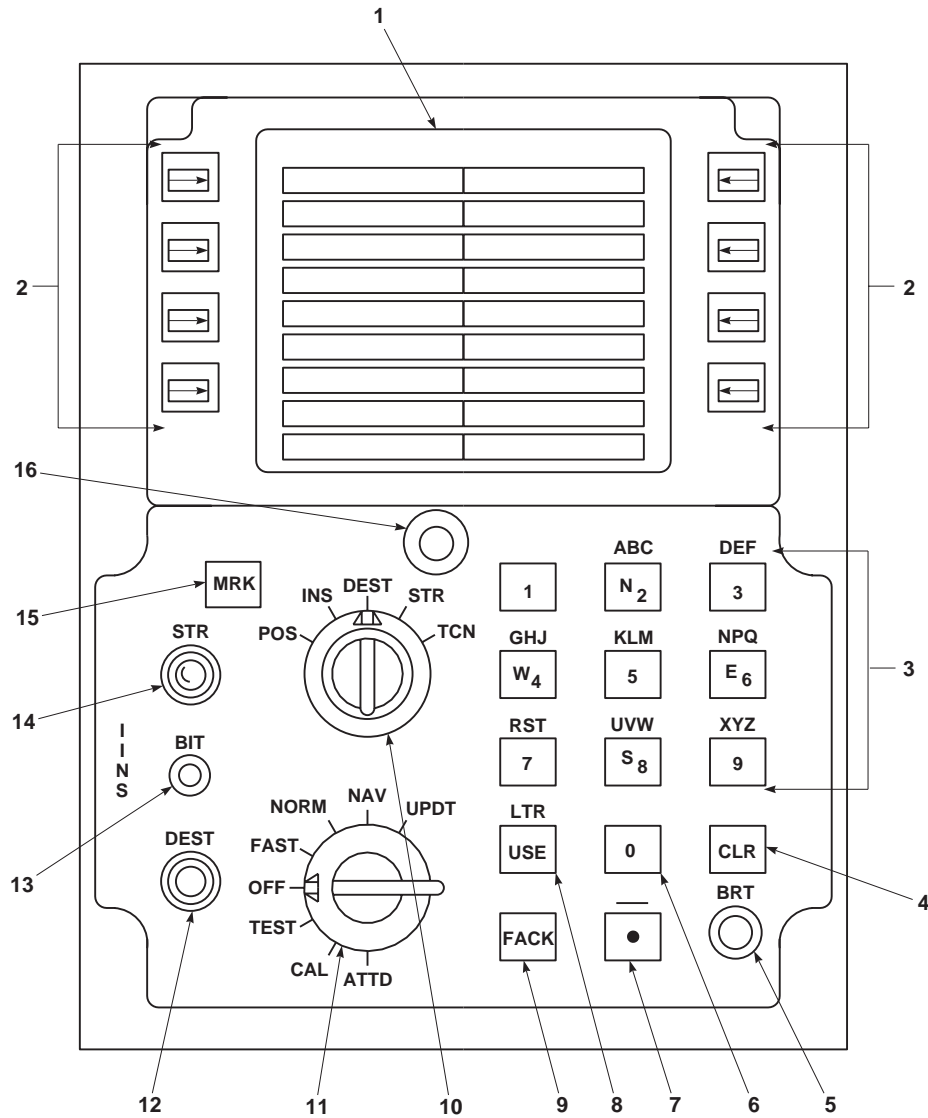

AA0391
SA

Figure 3-19. CDU Controls and Indicators **EH**

NOTE

If the **IINS** is to be turned **OFF** during flight, the **IINS** should be deselected on the **SYSTEMS SELECT** panel prior to **IINS** turn **OFF**.

3.23 PILOT AND COPILOT VSI/HSI MODE SEL PANEL. **EH**

The VSI/HSI **MODE SEL** Panel (Figure 3-21) modified for **IINS**, operates the same as the UH-60A. The **IINS** switch operation is as follows:

IINS

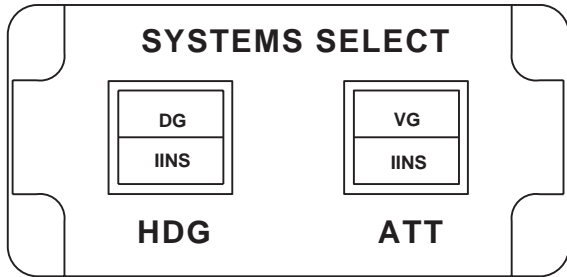

AA0392
SA

Figure 3-20. SYSTEMS SELECT Panel **EH**

Selection of **IINS** will display IINS calculated range, bearing, and course deviation to the steerpoint on the associated HSI. Range is displayed as distance (KM), bearing by the #1 pointer, and deviation by the course deviation bar.

Selection of **IINS** disconnects the VOR (ARN-123) TO/FROM output to the HSI's and connects the SCU TO/FROM output to the HSI's.

To select **IINS** on the **MODE SEL** panels, **IINS** must be selected on the **SYSTEMS SELECT** panel. Also the CDU must be on and in the **NAV** mode.

3.23.1 Valid Entry Procedures. The following paragraphs describe valid entry formats for data which may be entered on each of five main pages. An inward pointing arrow indicates that data can be entered on that line by pressing the adjacent line select key.

a. **POS** (Position) Page. The position page provides for entry of mag/true heading (BATH alignment), present position (**FAST/NORM** alignment) and magnetic variation.

(1) **Magnetic True Heading Entry.** Magnetic heading and magnetic variation or true heading may be entered during the first 60 seconds of a **FAST** alignment. Scratch pad entries may be up to four numeric digits including an optional decimal point. If no decimal point is entered, whole degrees are assumed. Leading zeros are optional.

(2) **Latitude Entry.** Key in N or S and then the numeric digits. The first two digits are degrees, third and fourth are

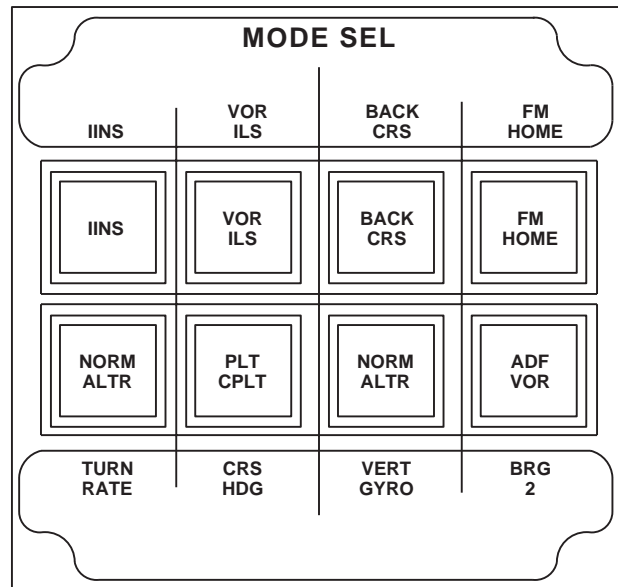

AA0393
SA

Figure 3-21. HSI/VSI MODE SEL Panel **EH**

minutes and fifth and sixth are seconds. A leading zero must be entered for any latitude less than 10 degrees. Entry examples:

PREVIOUS VALUE	SCRATCH PAD CONTENTS	ENTERED VALUE
S 6° 15 34	N263415	N 26° 34 15
N 33° 25 15	2634	N 26° 34 00
S 46° 13 00	S26	S 26° 00 00
S 46° 13 00	26	S 26° 00 00

(3) **Longitude Entry.** Key in E or W and then the numeric digits. A leading zero must be entered for a longitude less than 100 degrees and two leading zeros for a longitude less than 10 degrees.

PREVIOUS VALUE	SCRATCH PAD CONTENTS	ENTERED VALUE
E 176° 16 00	W1263415	W 126° 34 15

PREVIOUS VALUE	SCRATCH PAD CONTENTS	ENTERED VALUE
E 176° 16 00	12634	E 126° 34 00
W 135° 42 32	E126	E 126° 00 00
E 120° 16 24	126	E 126° 00 00

(4) Spheroid or Grid Zone Entry. Either spheroid or grid zone may be entered. Spheroid entries consist of numbers 0 through 10 and are an alpha display as listed in Table 3-2. Grid zone entries consist of two numbers and alpha character. Entry examples.

PREVIOUS VALUE	SCRATCH PAD CONTENTS	ENTERED VALUE
16T INT	1	16T CL6
16T INT	18T	18T INT
16T INT	18T1	18T CL6

(5) Area/Eastings/Northings Entry. Scratch pad entries may be made for area, eastings and northings, just area, or just eastings and northings. Entries for area must consist of two alpha characters. Entries for eastings/northings must be 2, 4, 6, 8, or 10 digits. Digits will be evenly split between eastings and northings with trailing zeros inserted. Although entries may be made and sent to the INU to a resolution of 1 meter, the display will round to the nearest 10 meters. The following illustrates several examples:

Table 3-2. Spheroid Data Codes ^{EH}

CODE	MODEL	ABBR
0	International	INT
1	Clark 1866	CL6
2	Clark 1880	CL0
3	Everest	EVR
4	Bessel	BSL
5	Australian National	AUS

Table 3-2. Spheroid Data Codes ^{EH} (Cont)

CODE	MODEL	ABBR
6	Airy	ARY
7	Hough	HGH
8	South American	SAM
9	Modified Everest	MEV
10	WGS.72	WGS

NOTE

When mission equipment operator selects WGS 1984, CDU is code 10.

PREVIOUS VALUE	SCRATCH PAD CONTENTS	ENTERED VALUE
AU 1234 5678	UV23456789	UV 2345 6789
AU 1234 5678	23456789	AU 2345 6789
AU 1234 5678	2345678	AU 2340 6780
AU 1234 5678	2367	AU 2300 6700
AU 1234 5678	26	AU 2000 6000
AU 1234 5678	UV	UV 1234 5678

(6) Magnetic Variation Entry. Scratch pad entries consist of an E/W and up to four numeric digits including decimal point. If no decimal point is entered, while degrees are assumed. The range of entries is 0.0° to E/W 180.0°. For entries greater than or equal to 100°, only whole degrees are displayed. The following gives some entry examples.

b. INS (Inertial) Page. The INS page provides miscellaneous control/display functions such as entry of altitude and barometric pressure and provides access to INU and NPU memory.

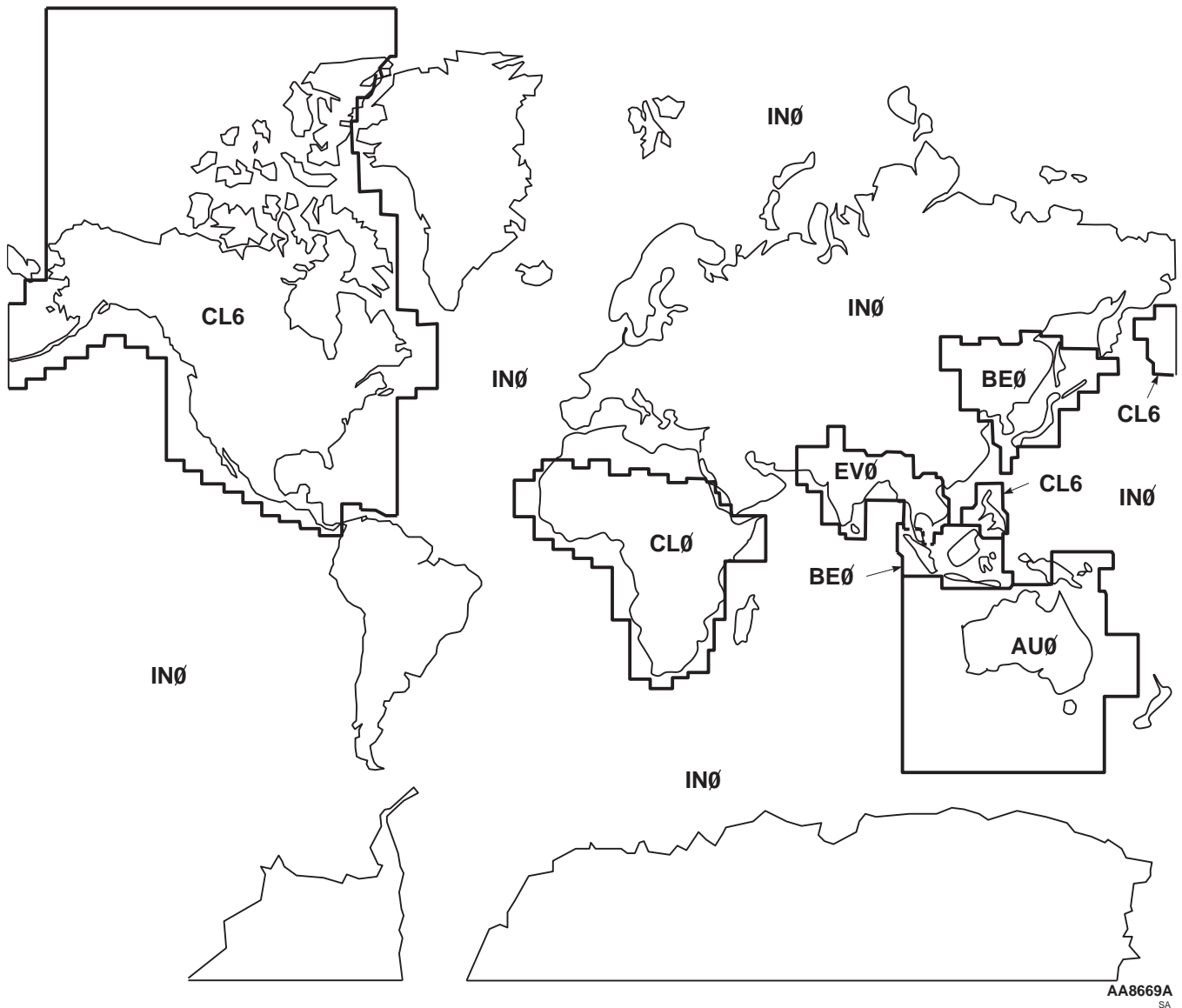

AA8669A
SA

Figure 3-22. Doppler World UTM Spheroids (AN/ASN-128)

(1) Manually Entered Altitude (MALT). Field altitude must be entered to the nearest 100 ft. MSL during alignment; however, manually entered altitude may be entered any time during the mission to override barometric altimeter. The range of valid entries is from -1000 to +65,520 feet in increments of 100 feet. Entries shall delete MALT by causing an output of -65,520 feet over the barometric pressure.

SCRATCH PAD CONTENTS	ENTERED VALUE
10	10.0
10.5	10.5

SCRATCH PAD CONTENTS **ENTERED VALUE**

2 2.0

(2) Barometric Pressure (BARO). Barometric pressure must be entered (0.01 in Hg) during alignment. The information is used by the NPU to initialize the scale factor of encoding altimeter data during alignment.

(3) DATA Page.

(a) Press the line select key adjacent to line 5 right (DATA).

(b) Line 7 of the DATA page provides the capability to enter and read the contents of various INU registers.

Although the CDU will accept entered memory addresses with a range of 0 to 65,535 (decimal), the INU will not accept all of these as valid. If an illegal address is entered, the illegal address and the message "**ENTRY REJECTED**" will alternately appear in the scratch pad. Pressing the **CLR**

key will clear the scratch pad. Register contents that are entered may be any six alphanumeric characters plus sign. Many of the INU registers are "read only". That is, their contents can be read but not altered. If an attempt is made to change the contents of one of these registers, "ENTRY REJECTED" will appear as described above.

c. **DEST** (Destination) Page. Two types of data may be entered on the destination page, destination coordinates, and course to destination.

(1) Destination Coordinates Entry. Destination coordinates may be entered during any phase of the mission. Either LAT/LONG or MGRS (UTM) coordinates may be entered. Coordinate selection is provided on line 7 (display right).

(a) Latitude entry described in paragraph 3.23.1.a.2..

(b) Longitude entry described in paragraph 3.23.1.a.3..

(c) Spheroid and zone entry described in paragraph 3.23.1.a.4..

(d) Area/Eastings/Northings entries described in paragraph 3.23.1.a.5..

(2) Course to Destination Entry. The desired true course to destination may be entered for each destination during any phase of the mission.

(a) Enter the true course in the scratch pad. Entries may be up to four numeric digits with an optional decimal point. If no decimal point is entered, whole degrees are assumed. Leading zeros are optional.

(b) Press line 1 right line select key. The true course to destination will be displayed on line 1 right.

(c) System will utilize any previous course data. If no data has been entered, the system will assume a true course of 000.0 degrees.

d. **STR** (Steer) Page. This page contains no enterable parameter.

e. **TCN** (TACAN) Pages. The TACAN pages consist of the TACAN control page and TACAN station pages.

(1) TACAN Control Page Data Entry. The only data entry on this page is channel number. Paragraph 3.23.3.f. describes the channel number entry.

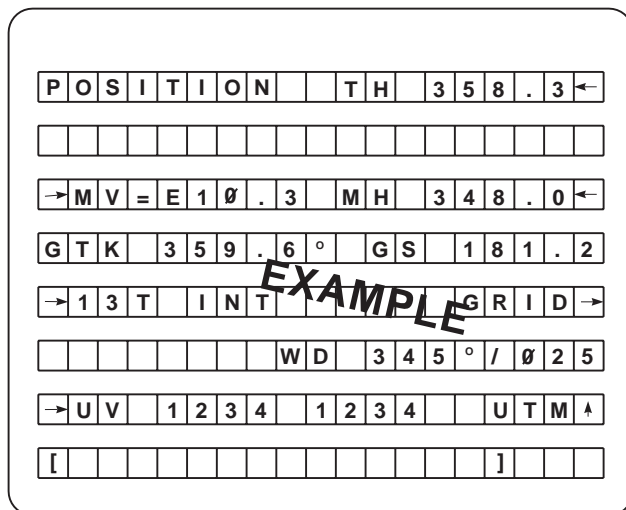

NOTE

TO SELECT THIS PAGE, SET CDU PAGE SELECT SWITCH TO POS AND PRESS LINE 5 AND / OR LINE 7 RIGHT LINE SELECT KEYS AS REQUIRED.

AA0396
SA

Figure 3-23. Position Page EH

(2) TACAN Station Page Entries. Parameter entries are station location magnetic variation channel and elevation.

(a) Latitude entry described in paragraph 3.23.1.a.2..

(b) Longitude entry described in paragraph 3.23.1.a.3..

(c) Spheroid and zone entry described in paragraph 3.23.1.a.4..

(d) Area/Eastings/Northings entries described in paragraph 3.23.1.a.5..

(e) Station Magnetics Variation entry described in paragraph 3.23.1.a.6..

(3) Station Channel Entry. The TACAN Station Pages provide the capability to enter station channel for each of the 16 stations. A total of 252 channel are possible (126 "X" channels and 126 "Y" channels). Unless "Y" is entered, an "X" channel is assumed.

3.23.2 Starting Procedure (NORMAL ALIGNMENT).

1. Ensure that the following circuit breakers are in.
 - a. **NO. 1 AC PRI BUS** circuit breaker panel
 - (1) **INS**
 - (2) **XFMR PWR**
 - (3) **INU BATT PWR**
 - (4) **26 VAC EQUIP PWR**
 - b. **NO. 1 DC PRI BUS** circuit breaker panel
 - (1) **CPLT ALTM**
 - (2) **IINS**
 - c. **NO. 2 AC PRI BUS** circuit breaker panel
 - (1) **TACAN**
 - d. **NO. 2 DC PRI BUS** circuit breaker panel
 - (1) **TACAN**

NOTE

Present position must be entered during the first two minutes of **NORM** alignment. If present position is displayed, it must be re-entered. A steady NAVRDY indicates INU attitude data and degraded NAV performance are available. After turn-on, flashing **NAVRDY** will be displayed on line 6 indicating full alignment.

2. To turn system on, set mode select switch to **NORM**. CDU display will remain blank for 30 seconds after turn-on. If the CDU does not light after 30 seconds, rotate the brightness control on the CDU clockwise to provide a comfortable intensity level.
 - a. Check for annunciations on line 2 of the display. If any annunciation is flashing, return mode select switch to **OFF**.



Wait two minutes before returning mode select switch to NORM. Failure to do so will damage the INU.

- b. If mode select switch was turned off, rotate mode select switch to **NORM**. If an annunciation is still flashing, make an entry on DA Form 2408-13-1. Refer to paragraph 3.23.5 for an explanation of annunciations.

3. Set page selector switch to **POS** (Figure 3-23).

NOTE

If UTM coordinates are selected, the COMPLETE UTM coordinates must be entered for present position: GRID ZONE, SPHEROID, AREA, EASTINGS, and NORTHINGS.

4. Verify line 7 on right side display indicates desired COORDINATE SYSTEM (UTM or L/L). If not depress the line select key once to switch to the desired coordinate system.
 - a. Enter GRID ZONE/SPHEROID or LATITUDE in scratch pad.
 - b. Press line select key 5 left.
 - c. Enter AREA, EASTINGS, NORTHINGS, or LONGITUDE in scratch pad.
 - d. Press line select key 7 left.

NOTE

If INU computed MV is changed, updated MV will have to be manually entered as MV lines are crossed. If INU computed MV is utilized, automatic MV updating will be performed by the INU.

5. Verify line 3 on left side display indicates correct magnetic variation, MV.
 - a. If incorrect, enter MV in scratch pad.
 - b. Verify scratch pad entry is correct.

- c. Press line select key 3 left.
 - d. Verify line 3 left displays: - > MV = XNN.N. (The "=" sign indicates that a manual MV was entered and automatic MV updating will not occur.)
6. Rotate page select switch to **INS** (Figure 3-24).
- a. Enter barometric pressure of present position in scratch pad.
 - b. Press line select key 5 left.
 - c. Enter altitude of present position in scratch pad (e.g., 156 ft is entered as 0.156 and displayed as 0.2).
 - d. Press line select key 3 left.
7. Rotate page select switch to **DEST**.
- a. Press **DEST** toggle switch to select **DEST** desired page.
 - b. Press line select key 7 right to display desired coordinate system (**UTM** or **L/L**).
 - c. Enter grid zone and spheroid or latitude in scratch pad.
 - d. Press line select key 5 left.
 - e. Enter Area/Eastings/Northings or longitude in scratch pad.
 - f. Press line select key 7 left.
 - g. Press **DEST** toggle switch (Figure 3-19) to increment to the next page.
8. Rotate page select switch to **TCN**.



Potential radiation hazard exists at the TACAN antenna when the TACAN is turned on. Make sure that no person is within 3 feet of antenna. When TACAN is first turned on and line 3 left of CDU displays anything other than REC, immedi-

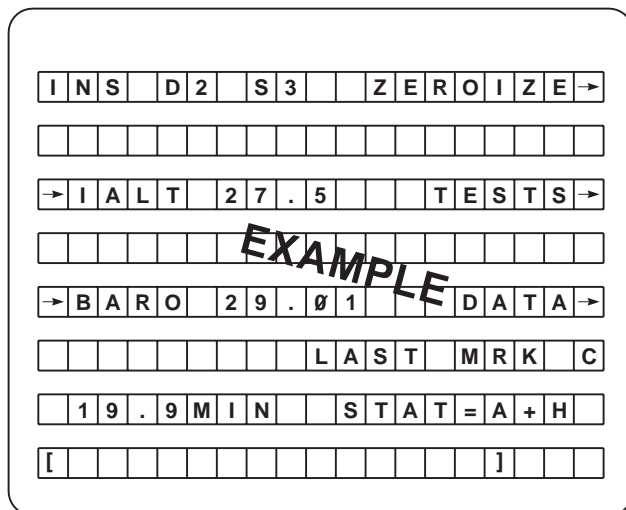

NOTE
TO SELECT THIS PAGE, SET CDU PAGE SELECT SWITCH TO INS.

AA0394
SA

Figure 3-24. INS Page

ately press line select key 3 left until the display shows REC.

- a. Turn ON TACAN by pressing line select key 1 left.
- b. Press line 3 left until REC is displayed on the CRT.
- c. Press page slew toggle switch to display TACAN station zero page.
 - (1) Enter magnetic variation in scratch pad.
 - (2) Press line select key 3 left.
 - (3) Enter latitude in scratch pad.
 - (4) Press line select key 5 left.
 - (5) Enter longitude in scratch pad.
 - (6) Press line select key 7 left.
 - (7) Press line select key 1 right to display ACT.

- (8) Enter channel number in scratch pad.
- (9) Press line select key 3 right.
- (10) Enter elevation of TACAN station on scratch pad.
- (11) Press line select key 5 right.
- (12) Press page slew toggle switch to display next TACAN page.
- (13) Enter data as described in steps (a) through (m).

NOTE

In order for HSI steering command to be correct, a valid destination and steer point must be entered prior to switching the **MODE** selector to **NAV**.

Example: If DX is homebase (alignment point), the SX STEER point is invalid as an initial Destination/Steer Point.

- 9. Select an appropriate destination number and toggle the **STR** toggle switch to indicate the number, i.e., S1. (It is not necessary that the DX and SX numbers agree, only that SX is the desired destination.)
- 10. Set mode select switch to **NAV**. (Pull switch up; then rotate.)
- 11. Set page select switch to **TCN**.
 - a. Press line select key 3 left to display T/R.
 - b. Press line select key 5 left to display UPDT.
- 12. On HSI/VSI **MODE SEL** panel (Figure 3-21), press **INNS** switch. Note that bearing to destination (No. 1 needle), range to destination, course deviation and **TO/FROM** flag are displayed on the HSI.
- 13. On **SYSTEMS SELECT** panel (Figure 3-20), set switches and observe indications as follows:
 - a. Press **HDG** switch, INS illuminates and inertial derived heading is displayed on the HSI.

- b. Press **ATT** switch, INNS illuminates and inertial derived pitch and roll is displayed on the VSI.

3.23.3 Starting Procedure (FAST Alignment).

Switching to **FAST** mode commands the INU to perform either a stored heading alignment or best available time heading (BATH) alignment.

- a. Stored Alignment.

NOTE

CDU display will remain blank for 30 seconds after turn on. Barometric pressure must be entered during alignment. Alignment will be complete when data display line 6 NAVRDY indicator begins to flash if a normal alignment was performed and the mode select switch was not set to NAV. Alignment will be complete when data display line 6 NAVRDY indicator lights if a normal alignment was performed and the mode select switch was set to NAV.

- (1) Ensure system preoperational checks have been performed and that aircraft power is on.
- (2) Set mode select switch (Figure 3-19) to **FAST**.
- (3) Set page select switch to **POS**.
- (4) Observe that data display line 7 right indicates desired coordinate system (**UTM** or **L/L**). If it does not, press line select key 7 right until the desired coordinate system is deployed.
- (5) If data display line 8 right indicates LTR, press LTR/USE key to place the keyboard in the numeric mode.
- (6) Observe that data display line 5 left and line 7 left indicate present position latitude and longitude or grid zone, spheroid area, eastings and northings, respectively. If not, normal or BATH alignment must be performed:
- (7) Set page select switch to **INS**. Observe that data display line 3 left indicates present position altitude. If not, a change must be

made within the first 60 seconds of this alignment.

NOTE

The following steps are an example of entering barometric pressure. Substitute your own barometric pressure when performing these steps. Enter local barometric pressure to the nearest 0.01 inches Hg.

When making keyboard entries, if an incorrect key is pressed, press **CLR** key as required and begin again.

- (8) Enter local barometric pressure on data display line 8 by pressing in sequence ABC/N2, XYZ/ 9, -/●, 0, and 1 keys. Observe that data display line 8 indicates 29.01.
- (9) Press data display line 5 left line select key. Observe that data display line 5 left indicates - > BARO 29.01.
- (10) Observe that data display line 7 indicates alignment and status.

NOTE

Data display line 6 left indicates a flashing NAVRDY if a normal alignment was performed and the mode select switch was not set to **NAV**.

- (11) When data display line 6 left NAVRDY indicator lights, set mode select switch to **NAV**.

b. BATH Alignment.

NOTE

CDU display will remain blank for 30 seconds after turn on. True or magnetic heading must be entered during the first 60 seconds of turn on. Present position must be entered within 2 minutes of turn on. Barometric pressure and altitude must be entered during alignment.

Alignment will be complete when data display line 6 NAVRDY indicator lights.

- (1) Ensure system preoperational checks have been performed and that aircraft power is on.
- (2) Set mode select switch to **FAST**.
- (3) Set page select switch to **POS**.
- (4) Observe that data display line 7 right indicates desired coordinate system (**UTM** or **L/L**). If it does not, press line select key 7 right until desired coordinate system is displayed.
- (5) If data display line 8 right indicates LTR, press LTR/USE key to place the keyboard in the numeric mode.

NOTE

The following steps are examples of entering present position data. Substitute your own present position and heading when performing these steps. Either true heading or magnetic heading can be entered. Magnetic heading is entered by pressing line select key. The following example uses true heading. When making keyboard entries, if an incorrect key is pressed, press **CLR** key as required and begin again.

- (6) Enter true heading on data display line 8 by pressing in sequence DEF/3, KLM/5, UVW/S8, -/ and DEF/3 keys. Observe that data display line 8 indicates 358.3.
- (7) Press data display line 1 right line select key. Observe that data display line 1 right indicates TH 358.3 <-.
- (8) If required, enter present position latitude (or UTM, GRID ZONE and SPHEROID) on data display line 8 by pressing in sequence LTR/USE, ABC/ N2, LTR/USE, DEF/3, GHJ/W4, 1, 0, DEF/3, and 0 keys. Observe that data display line 8 indicates N341030.
- (9) Press data display 5 left line select key. Observe that data display line 5 left indicates - > N34° 10 30.
- (10) If required, enter present position longitude (or UTM area, EASTING and NORTHING) on data display line 8 by pressing in

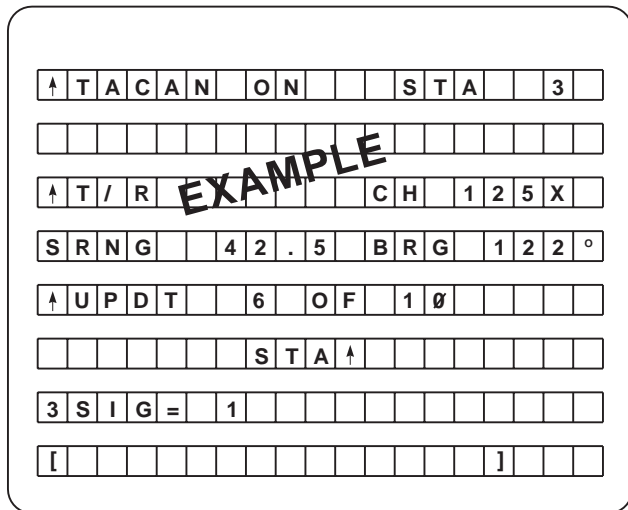

NOTE

TO SELECT THIS PAGE, SET CDU PAGE SELECT SWITCH TO TCN.

AA0395
SA

Figure 3-25. TACAN Control Page

sequence LTR/USE, GHJ/W4, LTR/USE, 1, 1, UVW/S8, DEF/3, and 0 keys. Observe that data display line 8 indicates W1183530.

- (11) Press data display line 7 left line select key. Observe that data display 7 left indicates - > W118° 35 30.

- (12) Set page select switch to **INS**.

NOTE

When entering present position altitude, altitude must be entered to the nearest 100 feet (mean sea level). The range of valid entries from -1000 to 65,520 feet in increments of 100 feet. Entries are made in thousands of feet.

- (13) If required, enter present position altitude on data display line 8 by pressing in sequence UVW/S8, -/●, and NPQ/E6 keys. Observe that data display indicates 8.6. This represents an altitude of 8,600 feet.

- (14) Press data display line 3 left line select key. Observe that data display line 3 left indicates -> AALT 8.6.

NOTE

Enter local barometric pressure to the nearest 0.01 inches Hg.

- (15) Enter local barometric pressure on data display line 8 by pressing in sequence ABC/N2, XYZ/9, -/●, 0, and 1 keys. Observe that data display line 8 indicates 29.01.
- (16) Press data display line 5 left line select key. Observe that data display line 5 left indicates - > BARO 29.01.
- (17) Observe that data display line 7 indicates alignment time and status.
- (18) When data display line 6 left NAVRDY indicator lights, set mode select switch to **NAV**.

3.23.4 In-flight Procedures.

a. **MARK** Operation. Current aircraft position may be stored in one of the markpoint locations (destinations A-F) by pressing the **MRK** key when in **NAV** mode. The location where present position was stored is displayed in the CDU scratch pad regardless of currently selected page. Figure 3-24 illustrates "MARK C" in the scratch pad with the **STR** page selected.

- (1) The **MARK** locations are used in sequence (-A, B, C, D, E, F, A, B,..). The **MARK** display will remain in the scratch pad unless it is cleared with the **CLR** key or the scratch pad is used to enter some other data.
- (2) Pressing the **MRK** pushbutton will freeze, for 30 seconds, the display of present position on the Steering and Position pages; and the display of cardinal headings/distance on both the destination and Steering Page. After 30 seconds or after the **CLR** key is pressed, the current position will return.

b. **Manual Updating (Overfly Position Updating)**. An overfly update represents a manual position update technique in which the pilot overflies his selected destination and signals the **INU** by pressing the **MRK** key. To initiate a manual update, proceed as follows.

NOTE

If indicated air speed is greater than 5 knots, the manual update will not remove 100% of the positional error or zero out the cardinal headings, time to go (TTG) or distance to destination. The percentage of actual update is a dynamic function of the computer software.

- (1) Indicated airspeed greater than 5 knots.
 - (a) Ensure that the displayed Destination and Steerpoint indicators (Dx, Sx) are both set to the destination that the update will be performed on.
 - (b) Rotate the mode select switch to the **UPDT** position. The page shown in Figure 3-26 will be displayed.
 - (c) When the aircraft is directly over the destination point, depress the **MRK** key. The page shown in Figure 3-27 will be displayed.
 - (d) If the pilot decides to accept the update (ACCEPT here means to tell the INU that the positional update will be accepted) depress line select key 7 left to accept the update (REJECT here means to tell the INU that the positional update will not be accepted), depress line select key 7 right to reject the update. In either case, the page shown in Figure 3-27 will be redisplayed.

NOTE

The following display changes are not immediate. It will take approximately 5 seconds for the data to change.

- (e) Rotate the mode select switch to **NAV**.
 - (f) Observe that the cardinal heading, time-to-go (TTG), and range decrease towards 0.0, and that present position changes to more closely reflect the coordinates stored in the selected destination.
 - (g) If the mission will continue, select a new steerpoint and proceed.
- (2) Indicated air speed is 5 knots or less.

- (a) Perform steps 1. (a) through 1. (f) above.
 - (b) If the cardinal headings, time-to-go (TTG) and range do not decrease to 0.0, verify that both the destination and steerpoint indicators (Dx, Sx) are set to the destination that the update is being performed on. Repeat steps 1. (a) through 1. (f).
 - (c) To proceed with the mission, select a new steerpoint.
- (3) Selection of the **"UPDT"** mode on the mode select switch deletes automatic TACAN updating during the period of the manual update.

3.23.5 Annunciations.

a. System status messages appear on line 2 and the left side of line 6 regardless of selected page. The following is a summary of messages that are presented and the failures/conditions they represent.

MESSAGE	CONDITION	LINE
MSC	Mission Computer has failed.	2
NPU	Navigation Processor has failed.	2
INU	INU navigation processing has failed	
	Attitude may be valid.	2
ADC	Copilot's Altimeter-Encoder has failed.	2
TCN	TACAN has failed or is off.	2
PFM	Post Flight maintenance is required.	2
TTG	Aircraft is within two minutes of selected steerpoint (flashing).	2
FROM	Distance to steerpoint is increasing.	2
TO	Distance to steerpoint is decreasing.	2
SCU	Signal Converter Unit or ARINC BUS has failed. (See TEST page.)	2

MES-SAGE	CONDITION	LINE
NAVRDY (steady)	During alignment. INU attitude data and degraded nav performance are available.	6
NAVRDY (flashing)	During alignment. Full INU nav performance is available.	6
ATTD	The INU is in attitude mode due to: 1. operator selection. 2. INU failure or 3. data bus failure. Attitude data is valid.	6
DEGRD	The INU is in navigate mode and a degraded performance alignment, not a full performance alignment was performed.	6
UPDT	The INU is being automatically updated by the TACAN.	6
DEGUPD	Degraded mode update by TACAN.	6

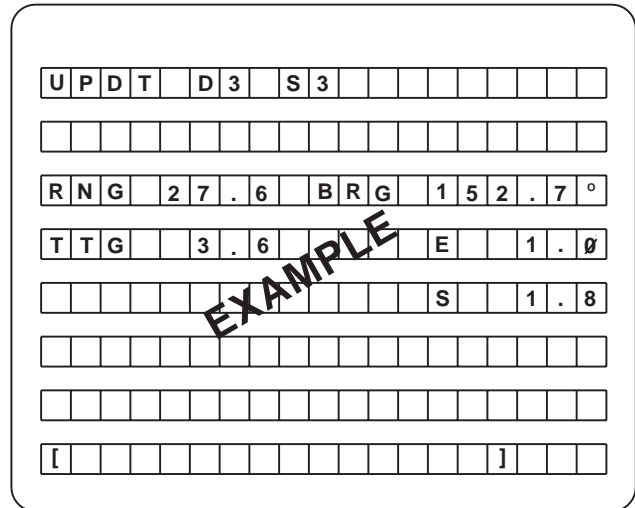

NOTE

TO SELECT THIS PAGE, SET CDU MODE SELECT SWITCH TO UPDT. WHEN THIS PAGE IS SELECTED, TACAN UPDATING IS DELETED.

AA0397
SA

Figure 3-26. Update Page

b. Placement of annunciation on their respective lines is shown in Figure 3-21. NPU and PFM annunciators occupy the same location. When a failure occurs, the annunciation will flash to attract the pilot's attention. Pressing the "FACK" key causes the annunciation to go from flashing to steady. If an LRU recovers from the failure, its annunciator will clear.

3.24 GYRO MAGNETIC COMPASS SET AN/ASN-43.

Gyro Magnetic Compass Set AN/ASN-43 provides heading information by reference to a free directional gyro when operating in the **FREE** mode, or by being slaved to the earth's magnetic field when operated in the **SLAVED** mode. It provides heading information to the horizontal situation indicator. Power to operate the AN/ASN-43 is provided from the ac essential bus through circuit breakers, marked **COMP** and **AUTO XFMR** under the general heading **AC ESNTL BUS**.

3.24.1 Compass Control C-8021/ASN-75. Control C-8021/ASN-75 (Figure 3-29) is required to synchronize

(electrically and mechanically align) the AN/ASN-43 to the correct magnetic heading when used in the **SLAVED** mode of operation. The synchronizing knob on the control panel may be used as a set heading knob for operation in the **FREE** mode.

3.24.2 Controls and Functions. Controls for the magnetic compass set are on the front panel of the unit. The function panel of each control is as follows:

CONTROL	FUNCTION
Null Meter	Moves left (+) or right (•) of center to indicate misalignment (synchronization) of the AN/ASN-43.
Mode Selector (SLAVED-FREE)	Selects either magnetically SLAVED or FREE gyro operation of the AN/ASN-43.

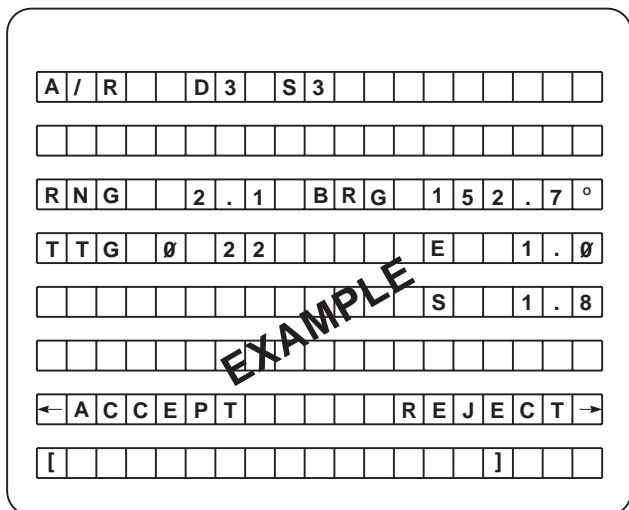

NOTE

TO SELECT THIS PAGE, SET CDU MODE SELECT SWITCH TO UPDT AND PRESS MRK KEY.

AA0398 SA

Figure 3-27. Accept/Reject Page **EH**

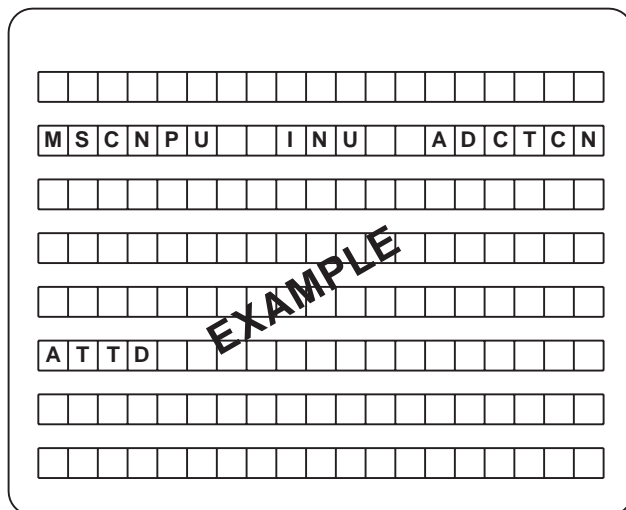

NOTE

SYSTEM STATUS MESSAGES APPEAR ON LINE 2 (2) AND THE LEFT SIDE OF LINE 6 (6) REGARDLESS OF SELECTED PAGE (EXCEPT NPU DATA PAGE). DATA APPEARING ON LINES 1 (1), 3 (3), 4 (4), 5 (5), 7 (7) AND 8 (8) WILL BE WHATEVER IS APPLICABLE TO THE PAGE SELECTED. THE FOLLOWING IS A SUMMARY OF MESSAGES THAT ARE PRESENTED AND THE FAILURES / CONDITIONS THEY REPRESENT:

AA0399 SA

Figure 3-28. System Annunciators **EH**

CONTROL

FUNCTION

Null Control
PUSH-TO-SET

Is manually pressed and turned to null the annunciator, thereby synchronizing (electrically and mechanically aligning) the AN/ASN-43. Turns compass card of HSI for alignment.

3.24.3 Operation.

3.24.4 Starting Procedure.

1. Mode selector - As desired.
2. Null control - Push, and turn in direction indicated by null meter (+ or •) until annunciator is centered. In **SLAVED** mode, during normal operation, the annunciator will oscillate slightly about the center position; however, during certain helicopter maneuvers the annunciator will move off center.
3. HSI - check to see that HSI heading agrees with a known magnetic heading.

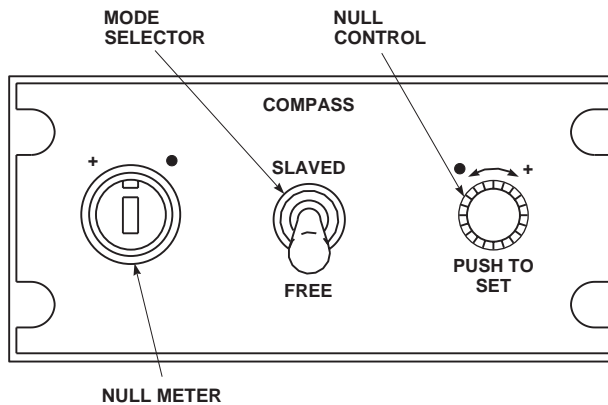

AA0527 SA

Figure 3-29. Compass Control Panel C-8021/ASN-75

3.25 ELECTRONIC NAVIGATION INSTRUMENT DISPLAY SYSTEM.

The instrument display system provides displays for navigation and command signals on a vertical situation indicator (VSI) and a horizontal situation indicator (HSI) for pilot visual reference. The system consists of the two VSIs and two HSIs on the instrument panel. The system has a

common command instrument system processor (CISP), two HSI/VSI mode select panels, and one CIS mode select panel.

3.25.1 Vertical Situation Indicator. The VSI (Figure 3-30), provides a cockpit display of the helicopter’s pitch, roll attitude, turn rate, slip or skid, and certain navigational information. It accepts command instrument system processor signals and displays the flight command information needed to arrive at a predetermined point. The system also monitors and displays warnings when selected navigation instrument readings lack reliability. The VSI is composed of a miniature airplane, four warning indicator flags **ATT**, **GS**, **NAV** and **CMD**, two trim knobs **ROLL** and **PITCH**, a bank angle scale, a bank angle index on the spheroid, a turn rate indicator and inclinometer, pitch and roll command bars, collective position pointer, a course deviation pointer, and a glide slope deviation pointer. Refer to Chapter 2, Section XIV for a description of the attitude indicating system, and turn and slip indicator. The gyro erect switch (Figure 2-8) supplies a fast erect signal to the pilot and copilot displacement gyros, thereby considerably reducing the time required for the gyros to reach full operating RPM. The pilot and copilot’s displacement gyros supply pitch and roll attitude signals to the vertical situation indicators, automatic flight control system, and the Doppler navigation system. Power to operate the VSI is provided from the No. 2 ac primary bus through circuit breakers marked **VSI PLT**, **CPLT**.

3.25.1.1 Steering Command Bars and Pointer. The roll and pitch command bars and the collective position pointer operate in conjunction with the command instrument system processor (CISP) and the command instrument system/mode selector (**CIS MODE SEL**). Selection of **HDG** on the **CIS MODE SEL** panel provides a display of a roll signal by the roll command bar (Figure 3-30). The pitch command bar and the collective position pointer are out of view, and the **CMD** flag is held from view. Selecting the **CIS MODE SEL** switch **NAV** and the **MODE SEL** switch **VOR ILS**, the roll command bar will display roll commands from the CISP. If an ILS (LOC) frequency is tuned in, the pitch command bar and the collective command pointer will also display CISP signals. If a VOR frequency is tuned-in, the pitch command bar and collective position pointer will be held from view. The **CMD** warning flag will be held from view, indicating that the CISP functional integrity is being monitored. Refer to Figure 3-32 for VSI indications in other switch positions.

3.25.1.2 Command Warning Flag. The command warning flag marked **CMD** is at the top left of the VSI face (Figure 3-30). It is held from view when initial power is applied to the CIS processor. When any CIS mode selector

switch is on, and that navigation system operating properly, the **CMD** flag is not in view. During operation, if the navigation signal becomes unreliable, or is lost, the **CMD** flag will become visible. On helicopters equipped with digital CIS processor the **CMD** flag will not come into view when the navigation signal becomes unreliable or lost. The **NAV** flag will come into view when the navigation signal becomes unreliable even with the digital CIS.

3.25.1.3 Glide Slope Warning Flag. A glide slope warning flag marked **GS** is on the right face of the indicator (Figure 3-30). The letters **GS** are black on a red/white stripe background. The warning flag will move out of view when the ILS receivers are operating and reliable signals are received.

3.25.1.4 Navigation Warning Flag. A navigation flag marked **NAV** is installed on both the VSIs and the HSIs (Figures 3-30 and 3-31) to indicate when navigation systems are operating and reliable signals are being received. The VSI **NAV** flag is marked **NAV** with a white background and red strips, and is on the lower left side of the indicator. The HSI **NAV** flag is within the compass card ring. Both instrument flags will retract from view whenever a navigation receiver is on and a reliable signal is being received.

3.25.1.5 Course Deviation Pointer. The course deviation pointer is on the VSI instrument (Figure 3-30). The pointer works with the course bar on the HSI to provide the pilot with an indication of the helicopter’s position with respect to the course selected on the HSI. The scales represent right or left off course, each dot from center (on course) is 1.25° for ILS, 5° VOR and FM. The pilot must fly into the needle to regain on-course track.

3.25.1.6 Glide Slope Deviation Pointer. The glide slope pointer, on the right side of the VSI (Figure 3-30), is used with ILS. The pointer represents the glide slope position with respect to the helicopter. Each side of the on-glide slope (center) mark are dots, each dot representing .25° above or below the glide slope.

3.25.1.7 Controls and Indicators. Indicators of the VSI are on the face of the instrument. The function of each indicator is as follows:

CONTROL/ INDICATOR	FUNCTION
Miniature airplane/ horizon line	Provides reference to artificial horizon.

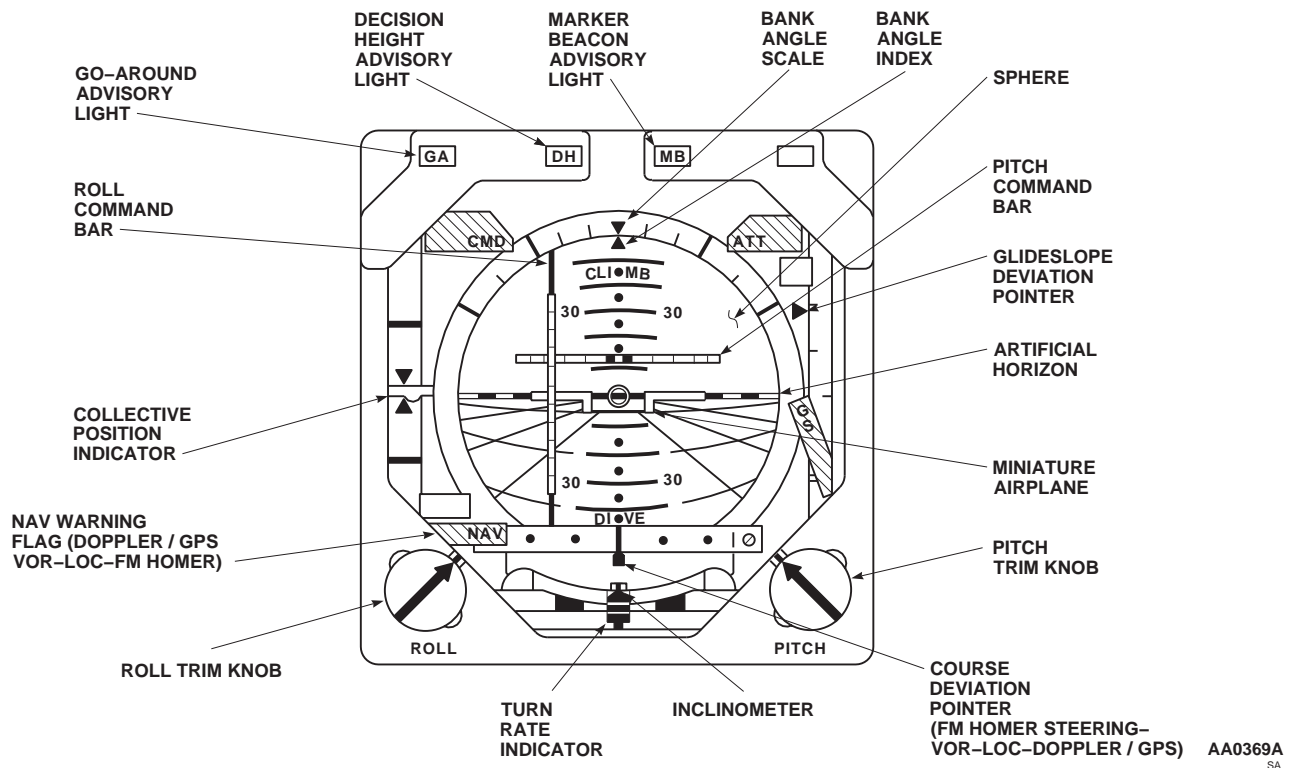

Figure 3-30. Vertical Situation Indicator

CONTROL/ INDICATOR	FUNCTION	CONTROL/ INDICATOR	FUNCTION
Bank angle scale	Right and left 0°, 10°, 20°, 30°, 45°, 60°, and 90° of bank.	GA	Go-around (GA) advisory light will go on whenever the GA switch on the pilot's or copilot's cyclic stick is pressed. The light will go off whenever the go-around mode is ended by engaging another mode on the CIS mode selector panel.
Artificial horizon	Reference of helicopter's attitude to horizon.	DH	Decision height (DH) advisory light will go on whenever the radar altimeter is operating and the altitude indicator is at or below the radar altitude L (low bug) setting.
Turn rate indicator	4-minute turn (one-needle width either side of center) 2-minute turn (two-needle width each side of center).	MB	Marker beacon (MB) advisory light will go on and the associated marker beacon tone will be heard, depending upon volume control setting, when the helicopter is over the marker beacon transmitter.
Pitch and roll command bars	Display to the pilot, control inputs he should make to arrive at a predetermined course, or glide slope.		
Collective position indicator	Display to the pilot the position of the collective relative to where it should be to arrive at a predetermined altitude.		

CONTROL/ INDICATOR	FUNCTION
Glide slope pointer	Displays to the pilot the position of the ILS glide slope relative to the helicopter. Pointer above center indicates helicopter is below glide path.
Course deviation pointer	Displays to the pilot the position of the course reference (VOR, LOC, DPLR, FM HOME) relative to the helicopter.
ATT warning flag	Indicates loss of vertical gyro power or VSI malfunction.
NAV warning flag	Indicates loss, or unreliable signal indication.
GS warning flag	Indicates loss, or unreliable signal indicator.
PITCH trim knob	Adjust artificial horizon up (climb) from at least 4°, no more than 10° or down (dive) from at least 8°, no more than 20°.
ROLL trim knob	Adjust artificial horizon right or left from at least 8° to no more than 20°.

3.25.2 Horizontal Situation Indicator. Two HSI (Figure 3-31) are installed on the instrument panel, one in front of each pilot. The HSI consists of a compass card, two bearing-to-station pointers with back-course markers, a course bar, a **KM** indicator, heading set (**HDG**) knob and marker, a course set (**CRS**) knob, a **COURSE** digital read-out, a to-from arrow, a **NAV** flag, and a compass **HDG** flag. The HSI's operating power is taken from the ac essential bus through a circuit breaker marked **HSI PLT/CPLT**.

3.25.3 Controls and Indicators. Controls of the horizontal situation indicators (Figure 3-31) are as follows:

CONTROL/ INDICATOR	FUNCTION
Compass card	The compass card is a 360° scale that turns to display heading data obtained from the compass control. The helicopter headings are read at the upper lubber line.

CONTROL/ INDICATOR	FUNCTION
COURSE set display	Displays course to nearest degree. Indicates same as course set pointer.
Bearing pointer No. 1	The pointer operates in conjunction with Doppler/GPS or IINS. Indicates magnetic bearing to Doppler/GPS or IINS destination set on FLY-TO-DEST UH or CDU EH .
Bearing pointer No. 2	The pointer operates in conjunction with selected VOR or ADF receiver. The pointer is read against the compass card and indicates the magnetic bearing to the VOR or ADF station.
Course deviation bar	This bar indicates lateral deviation from a selected course. When the helicopter is flying the selected course, the course bar will be aligned with the course set pointer and will be centered on the fixed aircraft symbol.
CRS knob	Course set (CRS) knob and the course set counter operate in conjunction with the course pointer and allow the pilot to select any of 360 courses. Once set, the course pointer will turn with the compass card and will be centered on the upper lubber line when the helicopter is flying the selected course.
KM indicator	Digital distance display in kilometers (KM) to destination set on Doppler FLY TO DEST .
HDG knob	Heading set (HDG) knob operates in conjunction with the heading select marker, allows the pilot to select any one of 360 headings. Seven full turns of the knob produces a 360° turn of the marker.
HDG warning flag	Visible when a failure occurs in the magnetic compass system.
To-From arrow	To-from arrow indicates that the helicopter is flying to or away from a selected VOR.

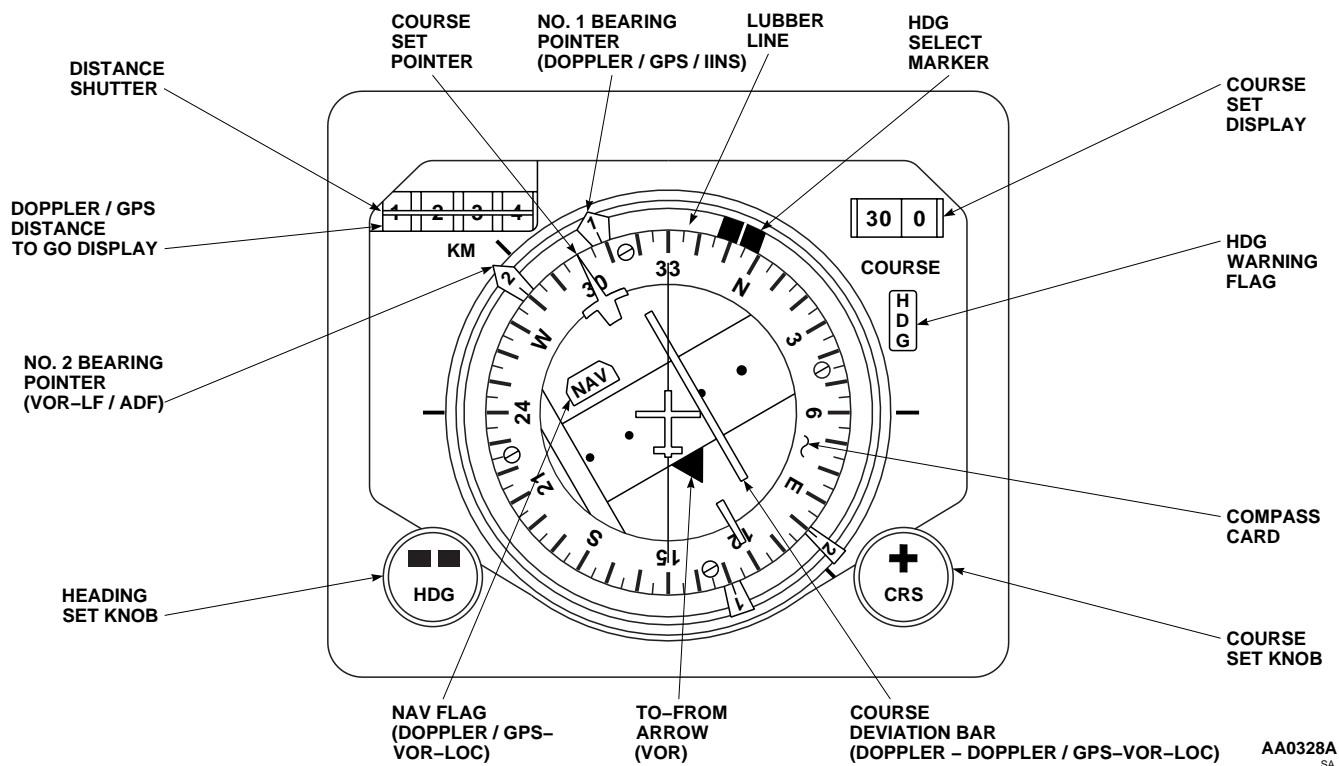

Figure 3-31. Horizontal Situation Indicator

CONTROL/ INDICATOR

FUNCTION

NAV flag

The NAV flag at the top of the to indicator, turns with the compass card. The flag will retract from view when a reliable navigation signal is being applied to the instrument.

switch is set to **TEST**. The original indications may be restored by pressing the applicable switches.

3.25.4.1 Controls and Functions. Controls of the mode selector panel (Figure 3-32) are as follows:

3.25.4 VSI/HSI and CIS Mode Selector Panels. The mode select panels (Figure 3-32) are integrally lighted, instrument panel mounted controls for the VSI, HSI, and CIS. The panels provide a means for selecting and displaying various navigation functions. Power to operate the pilot's **MODE SEL** is taken from the No. 2 dc primary bus through a circuit breaker, marked **PILOT MODE SELECT**. The copilot's **MODE SEL** takes power from the No. 1 dc primary bus through a circuit breaker, marked **CPLT MODE SELECT**.

CONTROL FUNCTION

- DPLR, DPLR/ GPS**: Directs Doppler **UH**, Doppler/GPS lateral deviation and NAV flag **UH** signals to VSIs and HSIs.
- VOR ILS**: Directs VOR or ILS signals to VSIs, and HSIs. Provides a signal to NAV flag.
- BACK CRS**: Reverse polarity of back course signal to provide directional display for VSIs and HSIs. Provides a signal to NAV flag.
- FM HOME**: Directs FM homing deviation and flag signals to VSIs.

NOTE

The switches on the VSI/HSI and CIS mode select panels may change state when the caution/advisory panel **BRT/DIM-TEST**

MODE OF OPERATIONS	 <p style="text-align: center;">CIS MODE SEL</p>	 <p style="text-align: center;">HSI / VSI MODE SELECTOR</p>
NONE	NONE	ANY
MANUAL HEADING	HDG	ANY
ALTITUDE HOLD	ALT	ANY
VOR NAVIGATION	NAV	VOR
ILS NAVIGATION	NAV	ILS
ILS APPROACH	NAV	ILS
ILS BACK COURSE	NAV	BACK CRS
LEVEL OFF	NAV	VOR / ILS / BACK CRS
GO-AROUND	NAV	VOR / ILS
DOPPLER, DOPPLER / GPS	NAV	DPLR, DPLR / GPS
FM HOMING	NAV	FM HOME

Figure 3-32. CIS Modes of Operation (Sheet 1 of 2)

 <p>CYCLIC ROLL COMMAND BAR</p>	 <p>CYCLIC PITCH COMMAND BAR</p>	 <p>COLLECTIVE POSITION INDICATOR</p>
OFF SCALE	OFF SCALE	OFF SCALE
PROCESSED CYCLIC ROLL COMMAND	OFF SCALE	OFF SCALE
OFF SCALE	OFF SCALE	PROCESSED COLLECTIVE POSITION
PROCESSED CYCLIC ROLL COMMAND	OFF SCALE	OFF SCALE
PROCESSED CYCLIC ROLL COMMAND	PROCESSED CYCLIC PITCH COMMAND	PROCESSED COLLECTIVE POSITION
PROCESSED CYCLIC ROLL COMMAND	PROCESSED CYCLIC PITCH COMMAND	PROCESSED COLLECTIVE POSITION
PROCESSED CYCLIC ROLL COMMAND	OFF SCALE	OFF SCALE
PROCESSED CYCLIC ROLL COMMAND	OFF SCALE OR PROCESSED CYCLIC PITCH COMMAND	PROCESSED COLLECTIVE POSITION
PROCESSED CYCLIC ROLL COMMAND	PROCESSED CYCLIC PITCH COMMAND	PROCESSED COLLECTIVE POSITION
PROCESSED CYCLIC ROLL COMMAND	OFF SCALE	OFF SCALE
PROCESSED CYCLIC ROLL COMMAND	OFF SCALE	OFF SCALE

AA0362_2
SA

Figure 3-32. CIS Modes of Operation (Sheet 2 of 2)

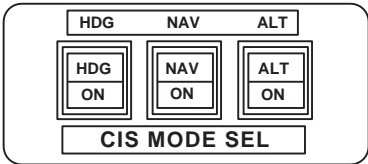
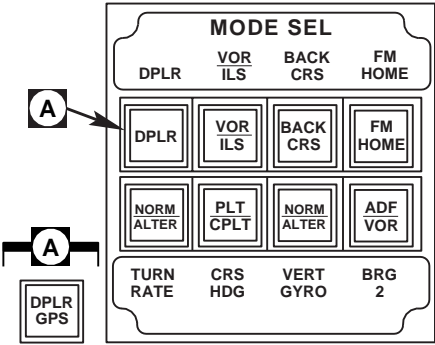
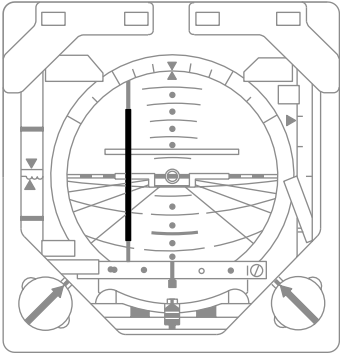
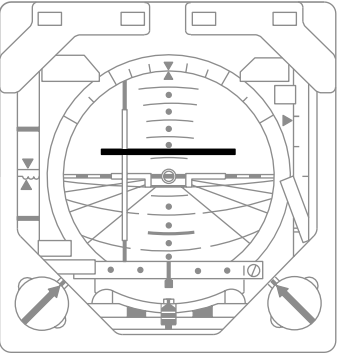
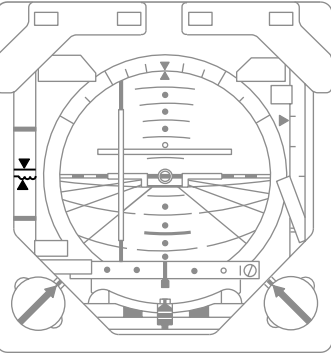
CONTROL	FUNCTION
TURN RATE NORM	Provides pilot and copilot with his own turn rate gyro information displayed on his VSI.
ALTR	Allows copilot's turn rate gyro information to be displayed on pilot's VSI, or pilot's gyro information to be displayed on copilot's VSI.
CRS HDG PLT	Provides for pilot's omni-bearing selector to be connected to navigation receiver and concurrent connection of pilot's HSI course datum and heading datum output to command instrument system processor.
CPLT	Provides for copilot's omni-bearing selector to be connected to navigation receiver and concurrent connection of copilot's HSI course datum and heading datum output to command instrument system processor.
VERT GYRO NORM	Provides pilot and copilot with his own vertical gyro information displayed on his VSI.
ALTR	Allows copilot's vertical gyro information to be displayed on pilot's VSI, or pilot's gyro information to be displayed on copilot's VSI.
BRG2 ADF	Allows pilot or copilot to select ADF on his No. 2 bearing pointer, each independent of the other.
VOR	Allows pilot or copilot to select VOR on his No. 2 bearing pointer, each independent of the other.
CIS mode selector	Selects one of three modes of operation to direct navigational signals to the CISP for Command Signal display.

CONTROL	FUNCTION
HDG ON	Direct heading and roll signals to CIS processor for steering commands that will allow pilot to maintain a selected heading.
NAV ON	Gives heading commands to acquire and track a selected VOR, ILS, DPLR, DPLR/GPS, or FM intercept, or to acquire and track glide slope beam.
ALT ON	Directs barometric pressure signals and collective stick position signals to CIS processor.

3.25.4.2 Off Mode. The command instrument system off mode (no switch legends lit) causes the cyclic roll, cyclic pitch and collective command pointers on both vertical situation indicators to be stowed out of view and the command warning flag on both VSIs to be biased out of view. The CISP is in the off mode upon initial application of electrical power, before the pilot selects either **HDG**, **NAV** or **ALT** mode on the CIS mode selector. When **NAV** mode is selected, the CISP remains in the off mode unless the **DPLR**, **DPLR/GPS**, **VOR ILS** or **FM HOME** navigation data has been selected on the pilot's VSI/HSI mode selector. The CISP will return to the off mode whenever the **HDG**, **NAV**, and **ALT** hold modes are disengaged, as indicated by the respective **ON** legends going off, or by turning off the associated navigation receiver. Separate modes are manually disengaged by pressing the mode switch when **ON** is lit.

3.25.4.3 Heading Mode. The heading mode processes the heading error and roll attitude signals to supply a limited cyclic roll command, which, when followed, causes the helicopter to acquire and track the heading manually selected on either pilot's HSI. The processed signal causes the VSI cyclic roll command bar to deflect in the direction of the required control response; i.e., bar deflection to the right indicates a coordinated right turn is required. When properly followed, the command results in not more than one overshoot in acquiring the selected heading and a tracking error of not more than 2°. The processor gain provides 1° of roll command for each degree of heading error

up to a roll command limit of approximately 20°. The CISP heading mode is engaged by momentarily pressing the **HDG** switch on the pilot's CIS mode selector, or as described in paragraph 3.25.4.5.

3.25.4.4 Altitude Hold Mode. The altitude hold mode processes barometric pressure signals from the air data transducer in addition to the collective stick position signal. When the **ALT** switch on the pilot's CIS mode selector is pressed, the CISP provides collective command signals, which, when properly followed, cause the helicopter to maintain altitude to within plus or minus 50 feet. The altitude hold mode synchronizes on the engagement altitude for vertical rates up to 200 feet per minute and provides performance for altitude inputs between -1000 and +10,000 feet at airspeeds from 70 to 150 KIAS. It is possible to engage the altitude hold mode, regardless of whether the heading mode or navigation mode is engaged, except that the CISP logic prevents manual selection of the altitude hold mode whenever the **NAV** mode is engaged and an ILS frequency is selected. This prevents the operator from selecting altitude hold mode during an instrument approach. The altitude hold mode is manually engaged by pressing the **ALT** hold switch (subject to above restriction) or automatically engaged as described in paragraph 3.25.4.7. The altitude hold mode may be manually disengaged by pressing the **ALT** hold switch when the **ON** legend is lit. Altitude hold may be disengaged also by selecting any other mode which takes priority (e.g., Go Around).

NOTE

ALT hold mode should be manually disabled during localizer, localizer backcourse, VOR, and ADF approaches.

3.25.4.5 Navigation Mode. The CISP navigation mode is engaged by pressing the **NAV** switch on the CIS Mode Selector. This navigation mode causes the CISP to enter the **VOR NAV**, **ILS NAV**, **DPLR NAV**, or **FM HOME** mode as selected on the pilot's VSI/HSI mode selector. The CISP provides steering commands based on the course selected on either the pilot's or copilot's HSI dependent on the mode select **CRS HDG** selection of **PLT** or **CPLT**.

3.25.4.6 VOR NAV Mode. The **VOR NAV** mode is established by selecting the **VOR/ILS** switch on the VSI/HSI mode selector and pressing the **NAV** switch on the CIS mode selector. The CISP processes the heading and course signals derived from either the pilot's or the copilot's HSI in addition to the lateral deviation and lateral flag signals applied to the pilot's VSI. The CISP provides a limited cyclic roll command, which, when followed, shall cause the helicopter to acquire and track the course setting manually

selected on the HSI. Engagement of the **VOR NAV** when the helicopter position is in excess of 10° to 20° from the selected radial will cause the initial course intersection to be made in the heading mode as described in paragraph 3.25.4.3. The CISP logic will light the CIS mode selector **HDG** switch **ON** legend during the initial course intersection. When the helicopter is within 10° to 20° of the selected course, the CISP beam sensor will capture the VOR lateral beam. The processor logic will turn off the **HDG** switch **ON** legend and the final course interception, about 45°, acquisition, and tracking will be based on the VOR lateral deviation signals. The processor causes the roll command pointer to deflect in the direction of the required control response. When properly followed, the command will result in not more than one overshoot at a range of 10 NM at a cruise speed of 100 ± 10 knots, and not more than two overshoots at ranges between 5 and 40 NM at speeds from 70 to 140 knots. When passing over the VOR station, the CISP reverts to a station passage submode and remains in this submode for 30 seconds. Cyclic roll commands during the station passage submode will be obtained from the HSI course datum signal. Outbound course changes may be implemented by the HSI **CRS SET** knob during the station passage submode. Course changes to a new radial, or identification of VOR intersections may be made before station passage by setting the HSI **HDG** control to the present heading and actuating the **HDG** switch. This will disengage the **NAV** mode and allow the pilot to continue on the original radial in the heading mode. A VOR intersection fix or selection of a new radial course may be made without affecting the CIS steering commands. Actuating the **NAV** switch re-engages the **VOR NAV** mode to either continue on the original VOR radial or to initiate an intercept to the new selected radial.

3.25.4.7 ILS NAV Mode. The instrument landing system **NAV** mode is established by selecting the **VOR/ILS** switch on the VSI/HSI mode selector, tuning a localizer frequency on the navigation receiver and selecting the **NAV** switch on the pilot's **CIS MODE SEL** panel. During the **ILS NAV** mode the CISP processes the following signals in addition to those processed during the **VOR NAV** mode: 1. The vertical deviation and vertical flag signals, 2. the indicated airspeed (IAS) and barometric altitude signals, and 3. the collective stick position sensor and helicopter pitch attitude signals. The indicated airspeed and pitch attitude signals are processed to provide a limited cyclic pitch command, which, when properly followed, will result in maintaining an airspeed that should not deviate more than 5 knots from the IAS existing at the time the **ILS NAV** mode is engaged. The pitch command bar will deflect in the direction of the required aircraft response, i.e., an upward deflection of the pitch bar indicates a pitch up is required. The **BAR ALT** and collective stick position signals are pro-

cessed to provide a limited collective position indication, which, when properly followed, will cause the helicopter to maintain the altitude existing at the time the **ILS NAV** mode is engaged. The collective position indicator will deflect in the opposite direction of the required control response, i.e., an upward deflection of the collective position indicator indicates a descent is required. The CISP will cause the **ALT** hold switch **ON** legend to light whenever the altitude hold mode is engaged. Actuating the **ALT** hold **ON** switch will disengage the altitude hold mode. Desired approach runway course must be set on the **CRS** window of the HSI selected by the **PLT/CPLT** indication of the **CRS HDG** switch. The initial course intersection and the localizer course interception, about 45°, acquisition, and tracking will be done as described for the **VOR NAV** mode except that not more than one overshoot at a range of 10 NM at 100 ± 10 KIAS, and not more than two overshoots at ranges between 5 and 20 NM should occur for airspeeds between 70 and 130 KIAS.

3.25.4.8 Approach Mode. The approach mode, a submode of the **ILS NAV** mode, will be automatically engaged when the helicopter captures the glide slope. During the approach mode, the CISP processes the vertical deviation, **GS** flag, and collective stick position signals to provide a limited collective position indicator, which, when properly followed, shall cause the helicopter to acquire and track the glide slope path during an approach to landing. When the glide slope is intercepted, the CISP logic disengages the altitude hold mode and causes the **ON** legend of the **ALT** hold switch to go off. The CISP will provide a down movement of the collective position indicator to advise the pilot of the transition from altitude hold to glide slope tracking, and to assist in acquiring the glide slope path. The cyclic roll commands are limited to ± 15° during the approach submode. When properly followed, the roll commands will result in the helicopter tracking the localizer to an approach. The collective position indicator, when properly followed, will result in not more than one overshoot in acquiring the glidepath and have a glidepath tracking free of oscillations. The cyclic roll and collective steering performance is applicable for approach airspeed from 130 KIAS down to 50 KIAS.

3.25.4.9 BACK CRS Mode. The back course mode is a submode of the **ILS NAV** mode and is engaged by concurrent **ILS ON** and **BACK CRS ON** signal from the pilot's HSI/VSI mode selector. The CISP monitors the localizer lateral deviation signals to provide cyclic roll commands, which, when properly followed, will allow the pilots to complete back course localizer approach in the same manner as the front course ILS. The desired final approach course should be set on the selected HSI **CRS** window.

3.25.4.10 Level-Off Mode. The level-off mode will be activated when either the **VOR NAV** or **ILS NAV** modes are engaged, and will be deactivated by selection of another mode or when a radar altitude valid signal is not present. The level-off mode is not a function of a VOR or ILS CIS approach. During ILS or VOR approaches, the barometric altimeter must be used to determine arrival at the minimum altitude. Radar altimeter setting shall not be used for level off commands in the **VOR NAV/ILS NAV** modes because variations in terrain cause erroneous altitude indications. The level-off mode provides the pilots with a selectable low altitude command. This mode is automatically engaged when the radar altitude goes below either the pilot's or copilot's radar altimeter low altitude warning bug setting, whichever is at the higher setting. A **DH** legend on the VSI and a **LO** light display on the radar altimeter indicator goes on whenever the radar altitude is less than the **LO** bug setting. The CISP monitors the radar altimeter and the collective stick position sensor to provide a collective pointer command, which, when properly followed, will cause the helicopter to maintain an altitude within 10 feet of the low altitude setting for settings below 250 feet, and 20 feet for settings above 250 feet. The CISP causes the **ALT** switch **ON** legend to light and the altitude hold mode to be engaged.

3.25.4.11 Go-Around Mode. The go-around mode processes roll and pitch attitude, altitude rate, collective stick position, and airspeed inputs in addition to internally generated airspeed and vertical speed command signals to provide cyclic roll, cyclic pitch and collective position indication. The go-around mode will engage when either pilot presses the **GA** (Go Around) switch on his cyclic control grip. When the go-around mode is engaged, the CISP immediately provides a collective position indication, which, when followed, will result in a 500 ± 50 fpm rate-of-climb at zero bank angle. Five seconds after the **GA** switch is pressed, the CISP will provide cyclic pitch bar commands, which, when followed, will result in an 80-KIAS for the climbout. The go-around mode is disengaged by changing to any other mode on the pilot's CIS mode selector.

3.25.4.12 Doppler, Doppler/GPS Mode. The Doppler, Doppler/GPS navigation mode is engaged by selecting the **DPLR, DPLR/GPS** switch on the VSI/HSI mode selector and the **NAV** switch on the CIS mode selector. Doppler and GPS combined navigation is the default setting on the AN/ASN-128B, but Doppler only or GPS only navigation can be selected from the **DLPR/GPS** CDU **GPS**. During the Doppler, Doppler/GPS navigation mode, the CISP processes Doppler, Doppler/GPS track angle error and the Doppler, Doppler/GPS **NAV** flag signals in addition to the roll angle input from the attitude gyro. The CISP

provides cyclic roll bar commands, which, when followed, result in a straight line, wind-corrected, flight over distances

greater than 0.2 kilometer from the destination. The course

deviation bar and course deviation pointer provide a visual display of where the initial course lies in relationship to the helicopter's position. The initial course is the course the Doppler, Doppler/GPS computes from the helicopter's position to the destination at the time the fly to destination thumbwheel is rotated (or entered from the keyboard). To achieve a pictorially correct view of the course, rotate the course knob to the head of the No. 1 needle when the fly to destination thumbwheel is rotated (or entered from the keyboard). The DPLR, DPLR/GPS NAV logic detects the condition of station passover, and automatically switches to heading mode. The switch to heading mode will be indicated by the **HDG** switch **ON** legend being turned on, and the **NAV** switch **ON** legend being turned off. The Doppler, Doppler/GPS navigation mode will not automatically re-engage, but will require manual re-engagement of the **NAV** switch on the CIS mode selector.

3.25.4.13 FM HOME Mode. The FM homing (Figure 3-32) is engaged by selecting the **FM HOME** switch on the pilot's VSI/HSI mode selector and the **NAV** switch on the pilot's CIS mode selector. Selecting FM homing on the VSI/HSI mode selector directs FM homing signals only to the VSI. Other **NAV** modes will be retained on the HSI if previously selected. During the **FM HOME** mode, the CISP processes the lateral deviation and flag signals displayed on the pilot's VSI in addition to the roll angle input from the attitude gyro. The CISP filters and dampens the FM homing deviation signals and provides cyclic roll commands to aid the pilot in homing on a radio station selected on the No. 1 VHF-FM communications receiver. When properly followed, the roll commands result in not more than two overshoot heading changes before maintaining a tracking error not to go over 3° . The CISP will revert to the heading mode whenever the lateral deviation rate is over $1.5^\circ/\text{sec}$ for a period of over 1 second. The CISP will cause the CIS mode selector **HDG** switch **ON** legend to light, and remain in the heading mode until the **FM** mode or some other mode is manually selected. Concurrent VOR and FM or concurrent DPLR and FM mode inputs will be considered an **FM** mode input to the CISP.

3.25.4.14 TURN RATE Select. The turn rate gyro selection provides each pilot the option of having his VSI display his own turn rate gyro signal (**NORM** operation) or of having the other pilot's turn rate gyro signal displayed (**ALTR** operation). The turn rate gyro selection is independent of the navigation modes selected by the top row of switches and is independent of which turn rate gyro the other pilot has selected. The **NORM** selection connects each pilot's VSI to his own turn rate gyro. The selection of **NORM** or **ALTR** operation is indicated by lighting the respective legend on the **TURN RATE** selector switch. The lamp power to the indicator legends is controlled

through a relay so that the **NORM** legend is lit in case the mode selector logic or lamp drivers fail. Sequential operation of the **TURN RATE** switch alternates the rate gyro connected to the VSI.

3.25.4.15 CRS HDG Select. The **CRS HDG** switch on the mode selector provides for either the pilot's or the copilot's course selector (**CRS**) to be connected to the navigation receiver, and for concurrent connection of the same pilot's HSI course and heading information to the command instrument system processor. The **CRS** resolver is normally connected to the pilot's HSI until selected by the copilot on his mode selector. **CRS HDG** control is transferred by pressing the **CRS HDG** switch. The pilot having the **CRS HDG** control is indicated by lighting of either the **PLT** or the **CPLT** legend on each mode selector. When power is first applied to the mode selector, the pilot's position is automatically selected. The **CRS HDG** selection is independent of the navigation modes selected by the top row of switches.

3.25.4.16 VERT GYRO Select. The vertical gyro selection provides each pilot the option of having his VSI display his own vertical gyro attitude (**NORM** operation), or of having the other pilot's vertical gyro attitude displayed (**ALTR** operation). The vertical gyro selection is independent of the navigation modes selected by the top row of switches and is independent of which vertical gyro the other pilot has selected. Each pilot's VSI is normally connected to his own vertical gyro. The selection of **NORM** or **ALTR** operation is indicated by lighting the respective legend on the **VERT GYRO** selector switch. The lamp power to the indicator legends is controlled through a relay so that the **NORM** legend is lit in case the mode selector logic or lamp drivers fail. Sequential operation of the **VERT GYRO** switch alternates the vertical gyro connected to the VSI.

3.25.4.17 No. 2 Bearing Select. The HSI number 2 bearing pointer selection allows the option of either the LF/ADF bearing or the VOR bearing to a selected station. The **ADF/VOR** selection is independent of the navigation modes selected by the top row of switches, and either pilot selects **ADF** or **VOR**, independent of the other pilot's selection. The number 2 bearing pointer is normally connected to the LF/ADF bearing output. The selection of either **ADF** or **VOR** bearing is indicated by lighting of the respective legend on the selector switch. The lamp power to the indicator legends is controlled through a relay, so that the **ADF** legend is lit in case the mode selector logic or lamp drivers fail. Sequential operation of the **ADF/VOR** switch alternates the bearing source connected to the No. 2 bearing pointer between **ADF** or **VOR**.

3.25.5 Operation.

a. Heading Hold.

- (1) **CIS MODE SEL** switch - **HDG**.
- (2) **HDG** set knob on HSI - Set as desired.
- (3) Selected heading is achieved by banking helicopter, to center roll command bar.

b. VOR Course Intercept.

- (1) Frequency - Set.
- (2) HSI **CRS** set knob - Set to desired course.
- (3) **CIS MODE SEL** switch - **NAV**.
- (4) Follow roll command bar to initially follow intercept heading and then follow command bar to intercept VOR course.

c. ILS Approach.

- (1) Frequency - Set.
- (2) HSI **CRS** set knob - Set to desired course.
- (3) **CIS MODE SEL** switch - **NAV**.

- (4) At two dots localizer deviation on HSI, follow roll command bar to intercept localizer.
- (5) As glide slope deviation pointer centers, follow collective position indications for glide slope tracking.
- (6) At decision height, press **GA** switch for go-around mode if breakout has not occurred.

d. Back Course Localizer Approach.

- (1) Frequency - Set.
- (2) **LO** altitude bug - SET to missed approach point HAT.
- (3) HSI **CRS** set knob - Set to inbound back course.
- (4) **CIS MODE SEL** switch - **NAV**.
- (5) **MODE SEL** switch - **BACK CRS**.
- (6) Fly same as front course (paragraph 3.25.5c(4)) . Turn off **MODE SEL ALT** legend to stow collective position indicator before making manual descent on back course approach.

Section IV TRANSPONDER AND RADAR

3.26 TRANSPONDER AN/APX-100(V)1 (IFF).

The transponder set (Figure 3-33) provides automatic radar identification of the helicopter to all suitably equipped challenging aircraft and surface or ground facilities within the operating range of the system. AN/APX-100(V) receives, decodes, and responds to the characteristic interrogations of operational modes 1, 2, 3/A, C, and 4. Specially coded identification of position (IP) and emergency signals may be transmitted to interrogating stations when conditions warrant. The transceiver can be operated in any one of four master modes, each of which may be selected by the operator at the control panel. Five independent coding modes are available to the operator. The first three modes may be used independently or in combination. Mode 1 provides 32 possible code combinations, any one of which may be selected in flight. Mode 2 provides 4096 possible code combinations, but only one is available and is normally preset before takeoff. Mode 3/A provides 4096 possible codes any one of which may be selected in flight. Mode C will indicate pressure altitude of the helicopter when interrogated. Mode C is only available if both mode 3/A and mode C switches are placed to the **ON** position. Mode 4 is the secure mode of cooperative combat identification, IFF operational codes are installed, the current period's code and either the previous or the next period's code. Power to operate the IFF system is provided from the No. 1 dc primary bus through a circuit breaker marked **IFF**. Refer to TM 11-5895-1199-12 and 11-5895-1037-12.

3.26.1 Antenna.



The transponder will ignore (and not respond to) interrogations received from the ground if the ANT switch is in the TOP position and will ignore interrogations received from above if the ANT switch is in the BOT position.

Flush-mounted antennas are installed on the top fairing between engine exhaust ports, (Figure 3-1) and under the transition section behind the UHF-AM antenna. They receive signals of interrogating stations and transmit reply signals. The AN/APX-100(V) is a diversity transponder, functioning to receive the rf interrogation from two antennas and transmit the reply via the antenna from which the stronger interrogation signal was received. If the **ANT**

switch is in the **TOP** position and the stronger signal was received from the bottom antenna, no rf reply will be transmitted. If the **ANT** switch is in the **BOT** position and the stronger signal was received from the top antenna, no rf reply will be transmitted. Therefore the **ANT** switch must be in the **DIV** position to insure the IFF will reply to all valid interrogations.

3.26.2 Controls and Functions. All operating and mode code select switches for transceiver operation are on Control Panel RT-1296/APX-100(V) (Figure 3-33).

CONTROL/ INDICATOR	FUNCTION
TEST GO	Indicates successful BIT.
TEST/MON NO GO	Indicates unit malfunction.
ANT-DIV switch	Allows the pilot to select the TOP (upper antenna), BOT (bottom antenna), or DIV (diversity, both antennas) of the aircraft.

NOTE

The **ANT-DIV** switch shall be placed in the **DIV** position at all times.

MASTER/OFF/ STBY/NORM/ EMER	Selects operating condition.
--	------------------------------

NOTE

Emergency reply provisions. This mode of operation is possible when the **MASTER** switch on the IFF control panel is placed in the **EMER** position and the system is interrogated. Emergency operation results in four short dashes on the interrogating radar indicator, which indicates an aircraft in distress, and singles out the aircraft in emergency condition within the group of aircraft. (The **MASTER** switch must be in **NORM**, then lifted and turned to **EMER**, therefore preventing the switch from accidentally being in **EMER**.) The emergency reply consists of a code 7700 in mode 3/A.

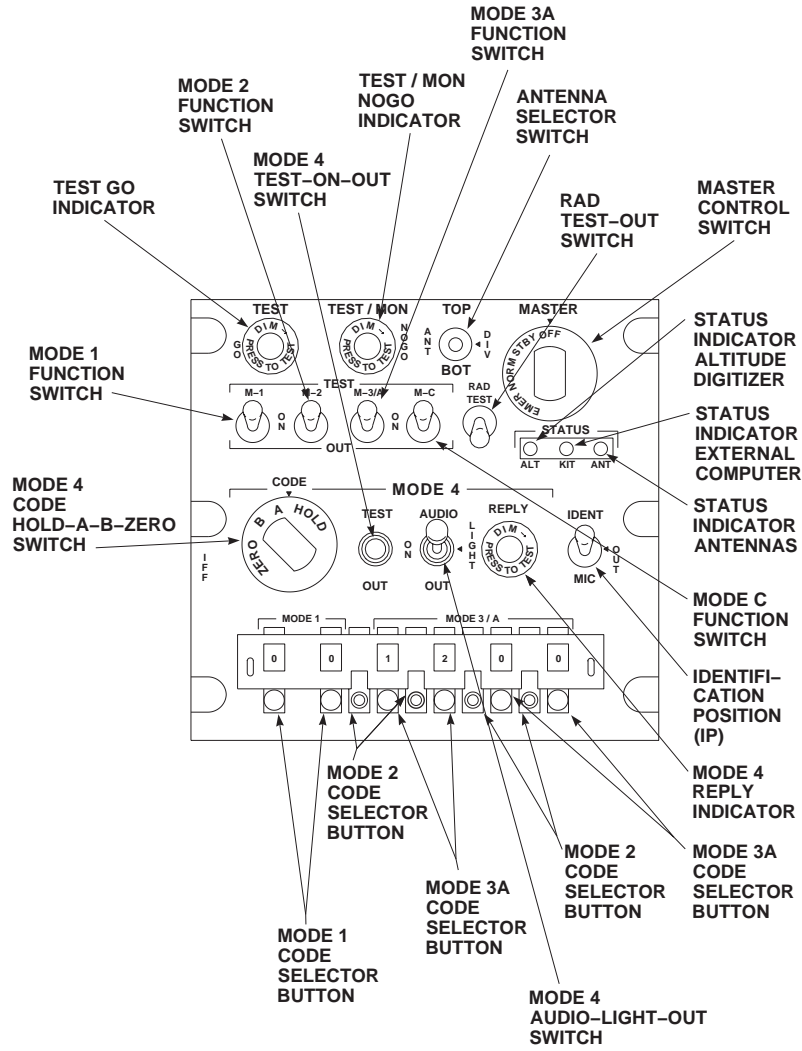

AA0363A
SA

Figure 3-33. Control Panel RT-1296/APX-100(V)

**CONTROL/
INDICATOR**

FUNCTION

**M-1, M-2,
M-3/A, M-C**
switches

The four, three position switches on the IFF control panel will enable or disable the system for modes **1**, **2**, **3/A**, or **C** operation. Mode **1**, mode **2**, mode **3/A**, or mode **C** replies are possible only when their respective switches are placed in the **ON** positions. Mode **C** is available only if both mode **3/A** and mode **C** are placed in the **ON** position. Mode **1** switches permit selection of a desired code from 00 through 73. Mode **2** and mode **3/A** switches permit selection of a desired code from 0000 through 7777. The **OUT** position if each switch prevents a reply to the respective mode interrogations. The **TEST** position of each switch tests the respective mode operation.

**RAD TEST/
OUT**

The **RAD** switch is used to allow the RT to reply to external test interrogation when held in the **RAD** position.

RAD TEST

Allows receiver transmitter to reply to external test interrogations.

OUT

Disables the **RAD TEST** features of the transponder.

STATUS ALT

Indicates that **BIT** or **MON** failure is due to altitude digitizer.

STATUS KIT

Indicates that **BIT** or **MON** failure is due to external computer.

STATUS ANT

Indicates that **BIT** or **MON** failure is due to cables or antenna.

**CONTROL/
INDICATOR**

FUNCTION

MODE 4 CODE
selector

When the IFF mode 4 computer is installed, mode 4 interrogations bypass the decoder in the RT and go directly to the crypto computer. In the crypto computer the mode 4 interrogation signal is decoded and applied to the mode 4 recognition circuit. When a mode 4 complete concurrence exists, the mode 4 recognition circuit generates a signal to the mode 4 computer which in turn generates a mode 4 reply. The **REPLY** light on the IFF control unit comes on to indicate a mode 4 reply is being transmitted.

ZERO

Zeroize code setting in computer.

A

Selects mode 4 code setting for previous, present, or next period, depending on which crypto period applies.

B

Selects mode 4 code setting for previous, present, or next period, depending on which crypto period applies.

HOLD

Retains mode 4 code setting when power is removed from transponder.

**MODE 4 TEST/
ON/OUT**

ON

Allows system to reply to mode 4 interrogations.

OUT

Prevents reply to mode 4 interrogations.

TEST

Provides self test for mode 4.

**MODE 4
AUDIO/LIGHT/
OUT**

AUDIO

Enables aural and **REPLY** light monitoring of valid mode 4 interrogations and replies. (Preferred position)

LIGHT

Enables only **REPLY** light monitoring of valid mode 4 interrogations and replies.

**CONTROL/
INDICATOR**

FUNCTION

WARNING

Placing the switch in the **OUT** position will disable mode 4 **REPLY** monitoring and **IFF** caution light.

OUT	Disables aural, REPLY light, and caution light monitoring of valid mode 4 interrogations and replies.
MODE 4 RE- PLY	Indicates that a mode 4 reply is transmitted.
IDENT/ OUT/MIC	The IDENT/OUT/MIC switch is spring loaded to the OUT position. If IDENT operation is desired, the switch must be moved to the IDENT position momentarily. The IDENT pulse trains will be transmitted for approximately 30 seconds. The MIC position is not connected in this installation.
MODE 1 selector buttons	Selects mode 1 reply code to be transmitted.
MODE 2 selector buttons	Selects four digit mode 2 reply code to be transmitted. (Located on the control panel or on the remote RT.)
MODE 3/A selector buttons	Selects four digit mode 3/A reply code to be transmitted.

3.26.3 Operation.

3.26.3.1 Starting Procedure.

CAUTION

When flying in a combat situation near friendly radar sites or in the vicinity of friendly fighter aircraft, the **MODE 4** monitor switch must be in either the **AUDIO** or **LIGHT** position. This will enable the pilot to observe that the **IFF** is periodically responding to expected **MODE 4** interrogations.

If the **MODE 2** code has not been set previously, loosen two screws which hold **MODE 2** numeral cover, and slide this cover upward to expose numerals of **MODE 2** code switches (Figure 3-33). Set these switches to code assigned to helicopter. Slide numeral cover down and tighten screws.

1. **MASTER** switch - **STBY. NO-GO** light should be on.
2. Allow 2 minutes for warmup.
3. **MODES 1** and **3A** **CODE** selector buttons - Press and release until desired code shows.
4. **TEST**, **TEST/MON**, and **REPLY** indicators -**PRESS-TO-TEST**. If **MODE 1** is to be used, check as follows:
5. **ANT** switch - **DIV**.
6. **MASTER** switch - **NORM**.
7. **M-1** switch - Hold at **TEST**, observe that only **TEST GO** indicator is on.
8. **M-1** switch - Return to **ON**. If modes **2**, **3A** or **M-C** are to be used, check as follows:
9. **M-2**, **M-3/A** and **M-C** switches - Repeat steps 7. and 8.

NOTE

Do not make any checks near a radar site or with **MASTER** control switch in **EMER**, nor with **M-3/A** codes 7500, 7600 or 7700, without first obtaining authorization from the interrogating station(s) within range of the transponder.

The following steps can be done only with **KIT/1A** computer transponder installed.

10. **MODE 4 CODE** switch - **A**.
 - a. Set assigned test code in the **KIT/1A** computer transponder.
 - b. **AUDIO-ON-OUT** switch - **OUT**.
 - c. **MODE 4 TEST-ON-OUT** switch - Place to **TEST** and hold, then release.
 - d. **TEST GO** light - **ON**, **MODE 4 REPLY** light off, **KIT STATUS** light off.

11. When possible, request cooperation from interrogating station to activate radar **TEST** mode.
 - a. Verify from interrogating station that **MODE TEST** reply was received.
 - b. **RAD TEST** switch - **RAD TEST** and hold.
 - c. Verify from interrogating station that **TEST MODE** reply was received.

3.26.3.2 Normal Procedures. Completion of the starting procedure leaves the AN/APX-100(V) in operation. The following steps may be required, depending upon mission.

1. **MODE 4 CODE** selector switch - **A** or **B** as required.
 - a. If code retention is desired, momentarily place the **MODE 4 CODE** selector switch to **HOLD** prior to turning the **MASTER** switch **OFF**.
 - b. If code retention in external computer is not desired during transponder off mode, place **MODE 4 CODE** selector switch to **ZERO** to dump external computer code setting.
2. Mode **M-1**, **M-2**, **M-3/A**, **M-C**, or **MODE 4** switches - Select desired mode.
3. Identification of position (I/P) switch - **IDENT**, when required, to transmit identification of position pulses.

3.26.3.3 Emergency Operation.

NOTE

MASTER control switch must be lifted before it can be switched to **NORM** or **EMER**.

During a helicopter emergency or distress condition the AN/APX-100(V) may be used to transmit specially coded emergency signals on mode 1, 2, 3/A and 4 to all interrogating stations. Those emergency signals will be transmitted as long as the **MASTER** control switch on the control panel remains in **EMER** and the helicopter is interrogated. **MASTER** control switch - **EMER**.

3.26.4 Stopping Procedure. **MASTER** switch - **OFF**.

3.27 TRANSPONDER COMPUTER KIT-1A/TSEC.

The transponder computer in the nose section of the helicopter operates in conjunction with mode 4. A caution light on the caution panel, marked **IFF**, will go on when a malfunction occurs in mode 4 or the computer that will prevent a reply when interrogated. Mode 4 operation is selected by placing the **MODE 4** switch **ON**, provided the **MASTER** switch is at **NORM**. Placing the **MODE 4** switch to **OUT** disables mode 4. **MODE 4 CODE** switch is placarded **ZERO**, **B**, **A**, and **HOLD**. The switch must be lifted over a detent to switch to **ZERO**. It is spring-loaded to return from **HOLD** to the **A** position. Position **A** selects the mode 4 code for the previous, present, or next period depending on which crypto period applies and position **B** selects the mode 4 code for previous, present, or next period depending on which crypto period applies. Both codes are mechanically inserted by a code-changing key. The codes are mechanically held in the transponder computer, regardless of the position of the **MASTER** switch or the status of helicopter power, until the first time the helicopter becomes airborne. Thereafter, the mode 4 codes will automatically zeroize any time the **MASTER** switch or helicopter power is turned off. The code setting can be mechanically retained. With weight on the landing gear, turn the **MODE 4 CODE** switch to **HOLD** (only momentary actuation is required) and release. Mode 4 codes can be zeroized any time the helicopter power is on and the **MASTER** switch is not in **OFF**, by turning the **CODE** switch to **ZERO**. Power to operate the transponder computer is provided automatically when the AN/APX-100(V) is on. The transponder computer KIT-1A/TSEC operation is classified.

3.28 CRYPTOGRAPHIC COMPUTER KIT-1C.

The cryptographic computer uses electronic key loading. Key loading is accomplished by use of the KYK-13 Electronic Transfer Device per TM 11-5810-389-13&P. The Cryptographic Computer Kit-1C operation is classified.

3.29 RADAR ALTIMETER SET AN/APN-209(V).

The radar altimeter set (Figure 3-34) provides instantaneous indication of actual terrain clearance height. Altitude, in feet, is displayed on two radar altimeter indicators on the instrument panel in front of the pilot and copilot. The radar altimeter indicators each contain a pointer that indicates altitude on a linear scale from 0 to 200 feet (10 feet per unit) and a second-linear scale from 200 to 1500 feet (100 feet per unit). An On/**OFF/LO** altitude bug set knob, on the lower left corner of each indicator, combines functions to serve as a low level warning bug set control, and an On/**OFF** power switch. The system is turned on by turning the

LO control knob, marked **SET**, of either indicator, clockwise from **OFF**. Continued clockwise turning of the control knob will permit either pilot to select any desired low-altitude limit, as indicated by the **LO** altitude bug. Whenever the altitude pointer exceeds low-altitude set limit, the **LO** altitude warning light will go on. Pressing the **PUSH-TO-TEST HI SET** control provides a testing feature of the system at any time and altitude. When the **PUSH-TO-TEST** control knob is pressed, a reading between 900 feet and 1100 feet on the indicator, and a reading between 900 and 1100 feet on the digital display, and the **OFF** flag removed from view, indicates satisfactory system operation. Releasing the **PUSH-TO-TEST SET** control knob restores the system to normal operation. A low-altitude warning light, on the center left of the indicator, will light to show the word **LO** any time the helicopter is at or below the altitude limit selected by the low altitude bug. Each pilot may individually select a low-altitude limit and only his **LO** light will go on when the low-altitude is reached or exceeded. Loss of system power will be indicated by the indicator pointer moving behind the dial mask and the **OFF** flag appearing in the center of the instrument. If the system should become unreliable, the flag will appear and the indicator pointer will go behind the dial mask, to prevent the pilot from obtaining erroneous readings. Flight operations above 1600 feet do not require that the system be turned off. The pointer will go behind the dial mask but the transmitter will be operating. Power to operate the AN/APN-209 is supplied from the No. 1 dc primary through circuit breakers, marked **RDR ALTM**.

3.29.1 Antennas. Two identical radar altimeter antennas (Figure 3-1) are on the cockpit section under the avionics compartment. One is for the transmitter and the other is for the receiver. The antennas are flush-mounted in the fuselage on the bottom of the helicopter.

3.29.2 Controls or Indicator Function. Control of the radar altimeter set is provided by the **LOW SET OFF** knob on the front of the height indicator. The knob, marked **HI SET**, also controls the **PUSH TO TEST** (Figure 3-34).

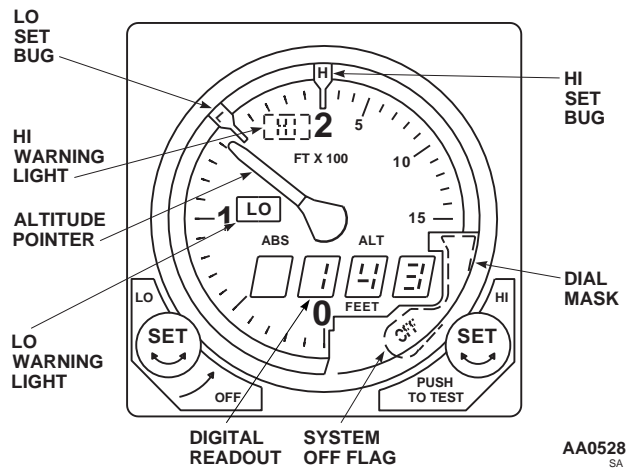

Figure 3-34. Radar Altimeter Set AN/APN-209(V)

CONTROL/INDICATOR	FUNCTION OR INDICATION
HI SET knob	Pushing knob actuates built-in test system to self-test altimeter.
Altitude pointer	Provides an analog indication of absolute altitude from zero to 1500 feet.
Digital readout	Gives a direct-reading four digit indication of absolute altitude from zero to 1500 feet.
LO warning light	Lights whenever dial pointer goes below L altitude bug setting.
HI warning light	Lights whenever dial pointer goes above H altitude bug setting.
OFF flag	Moves into view whenever altimeter loses track while power is applied.

3.29.3 Operation.

a. Starting Procedure.

- (1) **LO SET** knob - On.
- (2) **L** bug - Set to 80 feet.
- (3) **H** bug - Set to 800 feet.
- (4) Indicator pointer - Behind mask above 1500 feet.

CONTROL/INDICATOR	FUNCTION OR INDICATION
LO SET knob	Power control turned counterclockwise to OFF , clockwise to on.
L bug	Sets altitude trip point of LO warning light.
H bug	Sets altitude trip point of HI warning light.

b. Track Operation. After about 2 minutes of warm-up, the altimeter will go into track mode with these indications:

- (1) **OFF** flag - Not in view.
- (2) Altitude pointer - 0 ± 5 feet.
- (3) Digital readout - 0 to +3 feet.
- (4) **LO** warning light - Will light.
- (5) **HI** warning light - Will be off.

c. **HI SET** knob - Press and hold. The altimeter will indicate a track condition as follows:

- (1) **OFF** flag - Not in view.
- (2) Altitude pointer - 1000 ± 100 feet.
- (3) Digital readout - 1000 ± 100 feet.
- (4) **LO** warning light - Will be off.
- (5) **HI** warning light - Will light.
- (6) **HI SET** knob - Release. The altimeter will return to indications in step b. Track Operation.

3.29.4 Stopping Procedure.

LO SET knob - **OFF**.

3.30 MISSION EQUIPMENT INTERFACE.



The ECM antenna can be extended with the helicopter on the ground if the radar altimeter is turned off or removed from the installation, or the L (LO set) indicator is set below the radar altimeter indication.

Two signals are provided by the radar altimeter to the AN/ALQ-151(V)2 mission equipment. **RADAR ALTIMETER ON** indicates the altimeter is installed and has power applied. If this signal is not present, and the ECM antenna is not fully retracted, a signal is generated to light the **ANTENNA EXTENDED** capsule on the **CAUTION/ADVISORY** panel. The other signal, **RADAR ALTITUDE LOW**, is sent to the mission equipment when the aircraft altitude drops below the **LO** bug setting of the radar altimeter. The signal initiates automatic retraction of the ECM antenna, lights the **ANTENNA EXTENDED** capsule until the antenna is fully retracted, and disables the **ECM ANTENNA** switch.

CHAPTER 4

MISSION EQUIPMENT

Section I MISSION AVIONICS

4.1 TROOP COMMANDER'S ANTENNA.

The troop commander's antenna (Figure 3-1), on the upper trailing edge of the tail rotor pylon, provides for use of a VHF/FM mobile/man pack radio, such as the AN/PRC-25 or AN/PRC-77, from the cabin area. The antenna gives the troop commander the capability of liaison, command, and control of ground elements. A coaxial cable, coiled in the cabin ceiling near the left cabin door, is for connecting the antenna to the radio set.

4.2 CREW CALL SWITCH/INDICATOR. **EH**

The **CREW CALL** switch/indicators are on the instrument panel (Figure 4-1) and in the cabin at the DF and ECM consoles. The switches are used to provide signals between crew members to indicate communication is desired, and establishing ICS circuits between cockpit and cabin. When the pilot/copilot's **CREW CALL** switch is pressed in, it lights steady. This allows only one-way communication, from pilot/ copilot to mission equipment operator(s). All stations desiring to communicate must then place their respective intercom switches to **ICS**. To establish two- or three-way communications, the flashing switches must be pressed in. The pilot's **ICS** audio overrides all other mission equipment operator's audio. To establish communication from mission equipment operator(s) to pilot/ copilot, the DF and/or ECM operator must press in their respective **CREW CALL** switch. The DF and/or ECM operator(s) **CREW CALL** switch(es) will light steady. The pilot/copilot's **CREW CALL** light flashes. When the pilot/ copilot's **CREW CALL** switch is pressed in, the switch lights steady, and communications can then be established. In establishing communications, the first **CREW CALL** switch pressed will light steady, all others will flash until pressed in. To terminate two-way communication, the pilot/ copilot and mission equipment operator(s) must press the respective **CREW CALL** switch(es), causing all indicators to go off. In terminating communications, **CREW CALL** switches pressed in must be pressed to release. Power to

operate the **CREW CALL** system is provided from the No. 1 dc primary bus through a circuit breaker marked **LIGHTS ADVSY**.

4.3 CHAFF AND FLARE DISPENSER M130.

4.3.1 Chaff Dispenser M130. The general purpose dispenser M130 (Figure 4-1) consists of a single system (dispenser assembly, payload module assembly, electronics module and dispenser control panels) and a **CHAFF DISPENSE** control button (on the lower console) designed to dispense decoy chaff, M-1(Refer to TM 9-1095-206-13&P). The system provides effective survival countermeasures against radar guided weapon systems threats. The dispenser system, M130, has the capability of dispensing 30 chaff. Power to operate the chaff dispenser system is provided from the No. 1 dc primary bus through a circuit breaker, marked **CHAFF DISP**.

4.3.2 Flare Dispenser M130. **EH** The general purpose dispenser (Figure 4-1) consists of a single system dispenser assembly, payload module assembly, electronics module, and dispense control button (on the instrument panel), designed to dispense decoy flares M206. The system provides effective survival countermeasure against infrared sensing missile threats. The dispenser system has the capability of dispensing 30 flares. Power to operate the flare dispenser system is provided from the No. 1 dc primary bus through a circuit breaker marked **CHAFF DISP**.

4.3.3 Controls and Function. The dispenser control panel (Figure 4-1) contains all necessary controls to operate the dispenser system from the cockpit. The control panel is on the lower console.

CONTROL/ INDICATOR

FUNCTION

CHAFF counter

Shows the number of chaff cartridges remaining in payload module.

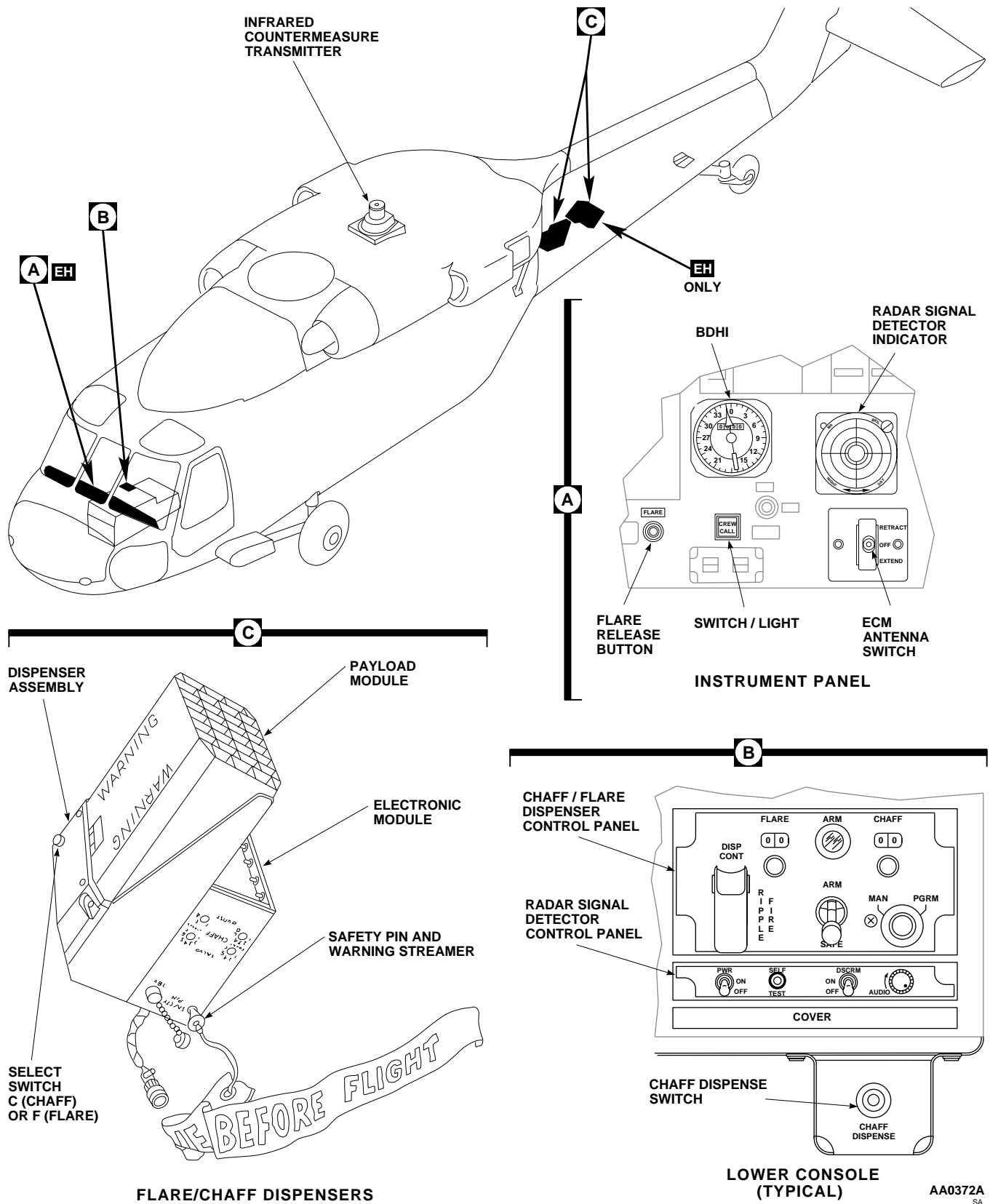

Figure 4-1. Mission Kits

CONTROL/ INDICATOR	FUNCTION
Chaff counter setting knob	Adjusts counter to correspond to number of chaff cartridges remaining in payload module.
PUSH-RESET	When pushed, resets chaff counter to "00".
ARM indicator light	Indicates that arming switch is at ARM , safety flag pin is removed, and payload module is armed.
ARM-SAFE switch	
ARM	Applies electrical power through safety flag switch to CHAFF DIS-PENSE button, and flare firing switch. Flare firing system is not used in this installation.
SAFE	Removes power from dispenser system.
FLARE counter UH	Not used in this installation.
Flare counter setting knob UH	Not used in this installation.
DISP CONT UH	Not used in this installation.
Mode selector	Selects type of chaff release operation.
MAN	Dispenses one chaff cartridge each time dispense button is pressed.
PGRM	Dispenses chaff according to predetermined burst/salvo and number of salvos automatically.
CHAFF DIS-PENSE	Ejects chaff cartridges from payload module.

4.3.4 Controls and Function. E3

CONTROL/ INDICATOR	FUNCTION
FLARE counter	Indicates the number of flare cartridges remaining in payload module.
Flare counter set knob	Adjusts counter to correspond to number of flare cartridges in payload module.

CONTROL/ INDICATOR	FUNCTION
DISP CONT RIPPLE FIRE	Release (jettison) all flares from payload module without pressing FLARE switch for each flare.
FLARE switch (Instrument panel)	Fires one flare from payload module each time switch is pressed.

4.3.5 Dispenser Assembly. The dispenser assembly (Figure 4-1) contains the breech assembly, C-F selector switch for either chaff or flares, a reset switch, and a housing containing the sequencer assembly. The sequencer assembly receives power through the firing switches circuit and furnishes pulses to each of the 30 contacts of the breech assembly, in sequential order 1 through 30, thus firing each of the impulse cartridges.

4.3.6 Payload Module Assembly. The payload module assembly (Figure 4-1) consists of the payload module and retaining plate assembly. The payload module has 30 chambers which will accept chaff. The chaff cartridges are loaded through the studded end of the module, one per chamber, and are held in place by the retaining assembly. The payload module assembly is assembled to the dispenser assembly.

4.3.7 Electronic Module Assembly (EM). The EM (Figure 4-1) contains a programmer and a cable assembly which includes a 28-volt supply receptacle and a safety switch, actuated by inserting the safety pin with streamer assembly. The programmer consists of a programming circuit which allows the setting of chaff burst number, chaff burst interval, chaff salvo number, and chaff salvo interval.

4.3.8 Electronics Module Controls. Controls on the electronic module are used to program the chaff dispenser for predetermined release of chaff cartridges. Controls on the electronic module are as follows: (Refer to TM 9-1095-206-13&P)

CONTROL	FUNCTION
SAFETY PIN	Safety switch to accept the safety pin with streamer, placing the dispenser in a safe condition when the helicopter is on the ground.
SALVO COUNT	Programs the number of salvos; 1, 2, 4, 8 or C (Continuous).

CONTROL	FUNCTION
SALVO INTER-VAL	Programs the time in seconds between salvos; 1, 2, 3, 4, 5, 8 or R (Random 2, 5, 3, 4, 3).
BURST COUNT	Programs the number of burst; 1, 2, 3, 4, 6 or 8.
BURST INTER-VAL	Programs the time in seconds for burst intervals; 0.1, 0.2, 0.3 or 0.4.

4.3.9 Safety Procedures. The safety pin shall be installed in the safety switch when the helicopter is parked. Safety pin is removed immediately before takeoff.

4.3.10 Operation.

1. Counter(s) - Set for number of cartridges in payload module(s).
2. Mode switch - **MAN**.

NOTE

Mode switch should always be at **MAN** when the **ARM-SAFE** switch is moved to **ARM** to prevent inadvertent salvo of chaff.

3. **ARM SAFE** switch - **ARM**. **ARM** indicator light on.
4. Dispense button press or mode switch **PGRM**, as required.

4.3.11 Flare Operation. E3

1. **FLARE** counter - Set for number of flare cartridges in payload module.
2. **ARM** switch - **ARM**.
3. **FLARE** switch (instrument panel) - Press for each release.

NOTE

If the flare detector does not detect burning of the first flare fired, another flare is automatically fired within 75 milliseconds; if burning is still not detected, a third and final flare is fired. If all three flares do not fire, automatic ejection of flares will stop until

the system is activated again by the **FLARE** switch.

4.3.12 Stopping Procedure. **ARM SAFE** switch - **SAFE**.

4.4 RADAR SIGNAL DETECTOR SET AN/APR-39(V)-1.

(Refer to TM 11-5841-283-12)

4.4.1 Controls and Function. The operating controls of the AN/APR-39(V)-1 panel (Figure 4-1) are as follows:

CONTROL	FUNCTION
PWR	Controls 28V from No. 1 dc primary bus.
ON	Turns set on. Fully operational after 1-minute warmup.
OFF	Turns set off.
DSCRM	Selects mode of operation.
ON	Activates discriminator circuit.
OFF	Deactivates discriminator circuit.
SELF TEST	When pressed, initiates self-test confidence check (except antenna, and receiver).
AUDIO	Controls volume to the interphone system.
Direction Display (scope display)	Shows a line-of-bearing radial strobe for each processed emitter signal.
MA indicator	Flashes on and off to indicate time correlation between missile guidance and associated tracking radar.
BRIL control	Varies brilliance of cathode ray tube (CRT) display.
Filter control	Varies density of red polarized faceplate filter (used for day or night operation) by moving a tang right or left.

4.4.2 Modes of Operation. The radar detector AN/APR-39(V)-1 may be operated in either the discriminator off or discriminator on mode.

NOTE

In this mode, received low band signals which are not correlated with a wide band intercept will cause the **MA** lamp to flash, and an alarm audio will be present.

b. Discriminator On Mode. When operating in the discriminator on mode, the **DSCRM** switch is placed **ON**. In this mode, signals are processed to determine their conformance to certain threat-associated criteria.

(1) The signal level must be greater than the minimum threshold level.

(2) Pulse width must be less than the maximum pulse width.

(3) PRF must be greater than the minimum pulses per second (PPS).

(4) The pulse train must exist with not less than minimum pulse train persistence.

(5) The CRT display is divided into eight sectors. Strokes are displayed only in those sectors in which signals meeting all threat criteria are present. This reduces display clutter by eliminating low-level and wide-pulse width signals and by selective sector display. Intercepts which meet these requirements are displayed as described in a. above.

NOTE

In this mode, uncorrelated low band signals will not give any indications.

(6) A typical display when operating in the discriminator **ON** mode is shown in Figure 4-3. Conditions are the same as for Figure 4-2, but is assumed that one or more threats have been identified in the 225° to 270° sector only.

4.4.3 Self-Test Procedures. The self-test (Figure 4-4) confidence checks all AN/APR-39(V)-1 circuits except, antennas, high-pass filters and detectors in the high-band receivers, bandpass filter and detector in the low-band receiver, analysis signal commutator, and high- and low-band blanking circuits. The self-test procedure is done before operation or when any malfunction is detected.

1. Apply power to AN/APR-39. Control unit panel lamps go on.

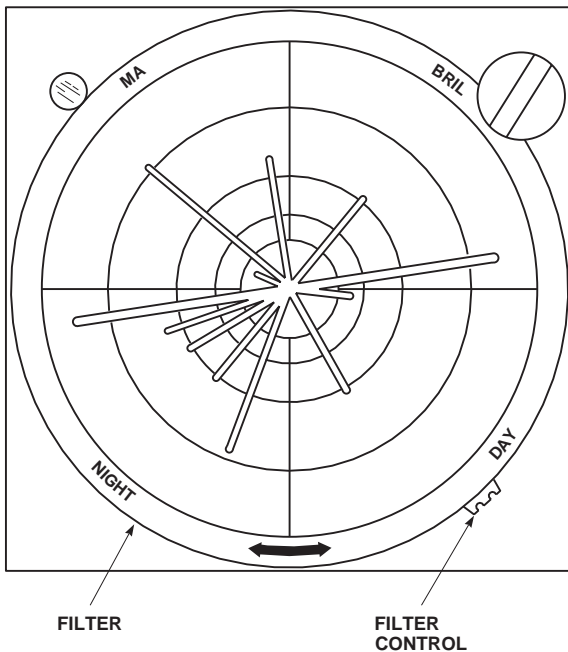

AA0529
SA

Figure 4-2. Discriminator Off Mode Display

NOTE

Display strobe lengths indicate only received signal amplitude. Since many variables can affect the atmospheric attenuation of the signals, strobe length should not be considered as a direct interpretation of the distance to the emitter.

a. Discriminator Off Mode. When operated in the discriminator off mode, the **DSCRM** switch is placed **OFF**. In this mode all high band received signals with an amplitude greater than the predetermined threshold level are displayed on the CRT and an audio signal, representative of the combined amplitudes and pulse repetition frequencies (PRF's), is present at the headset. The displays indicate the total radar environment in which the helicopter is operating. Each radial strobe on the CRT is a line of bearing to an active emitter. When a SAM radar complex becomes a threat to the helicopter (low band signals correlated with high band signals), the unique alarm audio is superimposed on the PRF audio signal and the MA lamp and associated strobe start flashing. Lengths of strobos and audio levels depend on the relative strength of the intercepted signals. A typical display when operating in the discriminator off mode is shown in Figure 4-2.

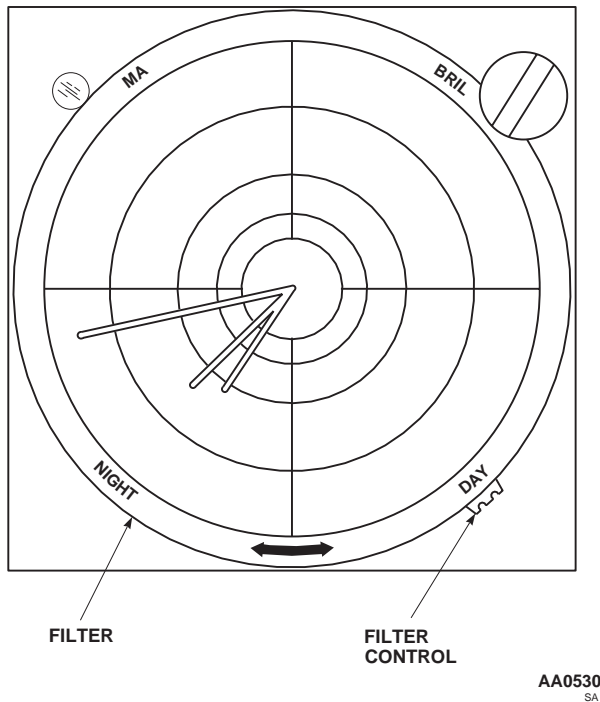

Figure 4-3. Discriminator On Mode Display

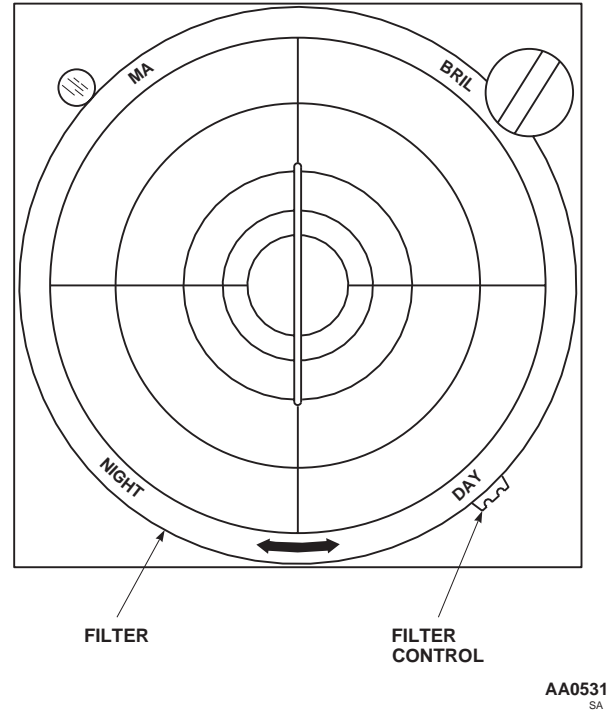

Figure 4-4. Typical Self-Test Mode Display

NOTE

In well-lighted areas it may be necessary to shade the panel to determine whether panel is lighted.

2. Place control unit **DSCRM** switch **OFF**, **PWR** switch **ON**, and wait 1 minute for warmup. Monitor indicator CRT and audio and press and hold **SELF TEST**.
 - a. Fwd and aft strobes appear, extending to about the third circle on the indicator graticule, and 2.5 kHz (approximately) PRF audio present immediately.
 - b. Within about 6 seconds, alarm audio present and the **MA** lamp starts flashing.
3. Turn indicator **BRIL** control clockwise and counterclockwise. Indicator strobes brighten (clockwise) and dim as control is turned. (Set control for desired brightness level.)
4. Turn control unit **AUDIO** control between minimum counterclockwise and maximum clockwise. Audio is not audible at minimum

counterclockwise and clearly audible at maximum clockwise.

5. Release **SELF TEST**. All indications cease.
6. Place **DSCRM** to **ON**. Press and hold **SELF TEST**.
 - a. Within about 4 seconds a forward or aft strobe (either may appear first) and 1.2 kHz (approximately) PRF audio present.

NOTE

Occasionally, during the period between pressing **SELF TEST** and appearance of the first strobe, a distorted dot on the indicator and intermittent audio will be present. This is not a fault indication.

- b. Within about 6 seconds the other strobe will appear and PRF audio frequency will double.
 - c. Several seconds later alarm audio present and **MA** lamp starts flashing.
7. Release **SELF TEST**. All indications cease.

8. Place control unit **PWR** switch **OFF**.

4.4.4 Operation Procedure. The procedure for turning on the equipment is as follows:



To prevent damage to the receiver detector crystals, assure that the AN/APR-39(V)-1 antennas are at least 60 yards from active ground radar antennas or 6 yards from active airborne radar antennas. Allow an extra margin for new, unusual, or high power emitters.

1. **PWR** switch - **ON**.
2. **SELF TEST** switch - Press and hold. Display should be a vertical line scope centerline.
3. **BRIL**, filter and **AUDIO** controls - Adjust as desired.
4. **SELF TEST** switch - Release.
5. **PWR** switch - As desired.

4.4.5 Stopping Procedure. **PWR** switch - **OFF**.

4.5 BEARING, DISTANCE, HEADING INDICATOR (BDHI). EH

The BDHI (Figure 4-1) at the center of the instrument panel consists of three indicators. The position of the indicator allows easy viewing by both pilot and copilot. The functions of the indicators are as follows:

- a. Compass Rose - displays the magnetic heading of the helicopter.
- b. Bearing Pointer - displays bearing to the signal received from an airborne or ground emitter/transmitter. The DF operator selects signal to be displayed.
- c. Distance Readout - displays, in kilometers, the distance to a signal emitter selected by the DF operator.

4.6 RADAR SIGNAL DETECTING SET AN/APR-39(V)2. EH

The radar signal detecting set indicates the relative position of search radar stations. Differentiation is also made between various types of search radar and tracking stations.



AA1635_1 SA

Figure 4-5. AN/APR-39(V)2 Control Panel

Audio warning signals are applied to the pilot’s and copilot’s headsets. The radar signal detecting set is fed through the 50-ampere **LH MAIN AVIONICS** and **RH MAIN AVIONICS** circuit breakers on the copilot’s circuit breaker panel and protected by the 7.5-ampere **APR-39** circuit breaker on the copilot’s circuit breaker panel. The associated antennas are shown in Figure 3-1. Refer to TM 11-5841-288-12.

4.6.1 Controls and Function. The operating controls of the AN/APR-39(V)2 panel (Figure 4-5) are as follows:

CONTROL	FUNCTION
PWR ON	Supplies 28 VDC to the Radar Detecting Set. Fully operational after one minute.
PWR OFF	Turns system off.
HI ALT	Selects high altitude mode of operation. Selection is based on aircraft mission profile.
LOW	Selects low altitude mode of operation. Selection is based on aircraft mission profile.
TEST	Initiates system self-test function when momentarily depressed downward. Permits flight line testing of Radar Detecting Set when held in the upward position. (Self test does not test antennas, antenna/receiver cabling.)

CONTROL	FUNCTION
Audio	Controls level of audio output to the aircraft interphone control system. Turn to the right for audio volume increase. Turn to the left for audio volume decrease.
Direction/Display (Scope/IP-1150)	Shows alphanumeric symbology for signals programmed in the processor emitter identification table.
MA indicator	Lamp flashes when low band signals associated with missile guidance systems are correlated with high band signals associated with tracking systems.
BRIL control	Varies the brilliance of the alphanumeric symbology.
Night-Day filter	Varies the intensity of the red polarizing face plate filter for day or night operation. If the IP-1150A is used in the aircraft, the day-night switch is not used as the IP-1150A is night vision compatible.

4.6.2 Processor Unit. The processor has a theater selection switch on the front of the processor. Selection of one of six theaters is possible depending on mission and geographical location.

4.6.3 Self-Test Procedures.

a. The self-test confidence checks all AN/APR-39(V)2 circuits except antennas, high pass filters and detectors in the high band receivers, bandpass filter and detector in the low band receiver, high low blanking circuits and antenna/receiver cabling.

b. The radar detecting set performs a self-test sequence when the **TEST** switch on the control unit is set to **TEST** and then released. This self-test takes seven seconds, during which time four different patterns are displayed. The alphanumeric symbology that is displayed at the 12, 3, 6 and 9 o'clock positions will vary depending upon the selected theater switch on the processor.

c. In the self-test, four patterns will be displayed in sequence (Figure 4-6) on the display **MA**. Pattern number

one alphanumeric displayed will depend on the selected theater position on the processor.

d. Observe that the radar signal indicator unit displays patterns 1-3 and finally, either the NO signal pattern or an actual threat pattern (Figure 4-6). As each of the first three patterns are displayed, a different type audio tone will flash on and off during the display of pattern number 3.

e. An "H" symbol will appear in the center of the NO signal pattern if the control unit **HI ALT/LOW** switch is in the **HI ALT** mode. Conversely, an "L" symbol will appear in place of the "H" symbol if this switch is in the **LOW** mode.

f. It is important for operators to note if the software version number displayed at the 12 o'clock position on the display is the same as the software version sticker attached to the rear of the processor.

4.7 RADAR SIGNAL DETECTING SET AN/APR-39A(V)1.

Refer to TM 11-5841-294-12.

4.7.1 Controls and Functions. The operating controls of the AN/APR-39A(V)1 are as follows:

CONTROL	FUNCTION
POWER	Controls 28VDC from the No. 1 dc primary bus
ON	Locks the switch in the ON position. System is fully operational after approximately one minute. On power up the synthetic voice will announce "APR-39 POWER UP". The plus (+) symbol will appear and be centered on the IP 1150A cathode ray tube (CRT) during system operation.
OFF	Turns system off. Switch must be pulled to unlock and turn system off.
TEST	When momentarily depressed initiates self-test confidence check (except for antennas and antenna receiver cabling).

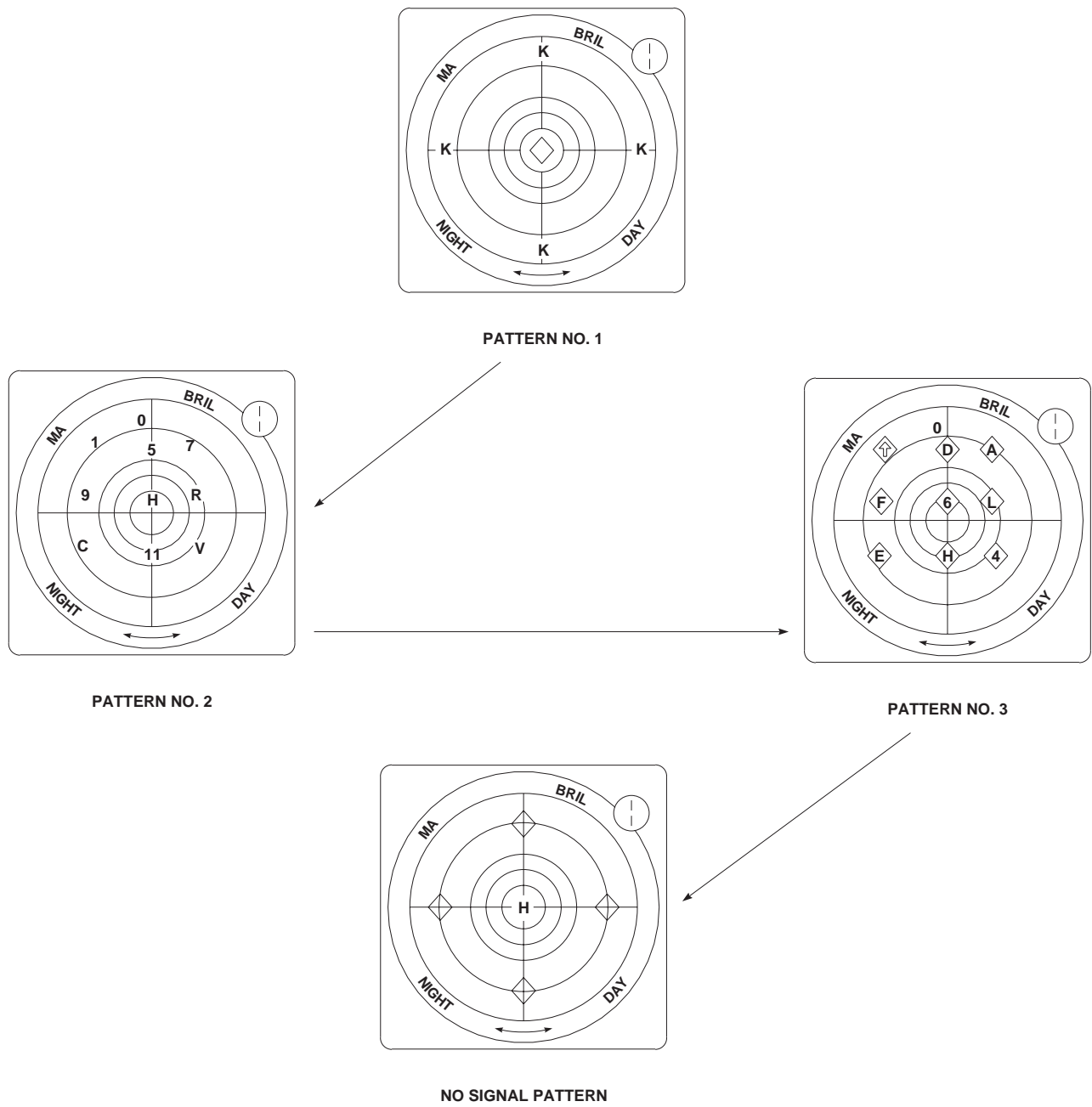

Figure 4-6. Self-Test Patterns AN/APR-39(V)2

CONTROL	FUNCTION
MODE	Selects synthetic voice message format only. MODE ONE (UP) selects normal voice message format. MODE TWO (DOWN) selects test/abbreviated voice message format.
AUDIO	Controls volume to the interphone system.
Direction/Display (Scope IP 1150A)	Shows alphanumeric symbology on a bearing for each processed emitter signal. Does not indicate any range data.
MA indicator	Not used.
MA switch	Not used.
BRIL control	Varies brilliance of CRT.



To prevent damage to the receiver detector crystals, assure that the AN/APR-39A(V)-1 antennas are at least 60 yards from active ground radar antennas or 6 yards from active airborne radar antennas. Allow an extra margin for new, unusual, or high power emitters.

Excessive indicator display brightness may damage CRT.

4.7.2 Modes of Operation.

a. Self test mode.

(1) After power up, the AN/APR-39A(V)1 synthetic voice will announce "APR-39 POWER UP" and the (+) symbol will stabilize in the center of the CRT. Self test should be initiated after approximately one minute. Self test can be performed in **MODE ONE** or **MODE TWO**. In **MODE ONE** the synthetic voice will announce "SELF TEST SET VOLUME, 1, 2, 3, 4, 5, 6, 7, 8, 9, 10, 11, 12, ". In **MODE TWO** the synthetic voice will announce "SELF TEST SET VOLUME, 5, 4, 3, 2, 1".

(2) The CRT will display specific software version numbers i.e., operational flight program (OFP) at the 12 o'clock position and the emitter identification data (EID) at the 6 o'clock position.

(3) After the software version numbers have been displayed the test sequence checks the receivers. A good visual self test will show two triangles, one at the 6 o'clock and one at 12 o'clock position on the CRT. Snowflake symbols (*) will appear at the 2, 4, 8, and 10 o'clock positions and will flash if the AN/AVR-2 laser detecting set is not installed. This is a normal indication and does not effect system performance.

(4) A good self test (no faults detected) ends with the message "APR-39 OPERATIONAL". A bad self test (faults detected) ends with the "APR-39 FAILURE".

b. **MODE ONE** operation. Selecting **MODE ONE** the operator will hear all the normal synthetic voice audio when an emitter has been processed e. g., the AN/APR-39A(V)1 will announce; "SA, S-18 12 O'CLOCK TRACKING". Selection of this mode does not have any effect on emitters received, processed or displayed, it only affects synthetic voice audio.

c. **MODE TWO** operation. Selecting **MODE TWO** the operator will hear an abbreviated synthetic voice audio e. g., the AN/APR-39A(V)1 will announce; "MISSILE 12 O'CLOCK TRACKING".

4.7.3 Function.

a. The radar signal detecting set (RSDS) receives, processes and displays pulse type signals operating in the C-D and H-M radio frequency bands. The emitters that it processes and displays are derived from the EID contained in the user data module (UDM) that is inserted in the top of the digital processor. In normal circumstances the processor is classified confidential if a classified UDM is installed.

b. The UDM contains the electronic warfare threat data that makes up the specific library for a specific mission(s) or a geographical location (it is theaterized). When a match of the electronic warfare data occurs the processor generates the appropriate threat symbology and synthetic audio. It is important therefore that the correct theaterized EID and UDM are installed for the mission or geographic location.

c. Symbol generation and position relative to the center of the CRT shows the threat lethality, it does not show or represent any lethality of range, but of condition/mode of the emitter. Highest priority threats (most lethal) are shown nearest the center. Each symbol defines a generic threat type, symbols are modified to show change in the status of the emitter. The symbols are unclassified, the definitions of what the symbols mean are classified. The complete set of symbols and definitions are contained in TM 11-5841-294-30-2. Each theaterized library EID has a specific classified

pilot kneeboard produced with it. The unit electronic warfare officer (EWO) should contact PM-ASE if sufficient cards are not available within his unit for the installed EID.

d. The RSDS on specific aircraft has been interfaced with other aircraft survivability equipment. The equipment includes the AN/AVR-2 laser detection set, AN/APR-44(V) continuous wave receiver and the AN/AAR-47 missile warning system.

4.8 INFRARED COUNTERMEASURE SET AN/ALQ-144(V).

WARNING

Do not continuously look at the infrared countermeasure transmitter (Figure 4-1) during operation, or for a period of over 1 minute from a distance of less than 3 feet. Skin exposure to countermeasure radiation for longer than 10 seconds at a distance less than 4 inches shall be avoided.

Ensure the countermeasure set is cooled off before touching the unit.

CAUTION

Observe that the IRCM INOP caution light illuminates when the OCU ON/OFF switch is set to OFF. After 60 seconds, observe that the IRCM INOP caution light extinguishes.

The countermeasure system provides infrared countermeasure capability. The system transmits radiation modulated mechanically at high and low frequencies using an electrically-heated source. A built-in test feature monitors system operation and alerts the pilot should a malfunction occur. The system is made up of a control panel on the instrument panel and a transmitter on top of the main rotor pylon aft of the main rotor. On helicopters Serial No. 78-22987 and subsequent, the countermeasure system functionally interfaces with the caution/advisory warning system through the left relay panel. The countermeasure system gets dc electrical power from the No. 2 dc primary circuit breaker panel and the No. 2 junction box. The 28 vdc is routed through the **IRCM PWR** circuit breaker in the No. 2 junction box to the transmitter. The No. 2 dc

primary bus also supplies 28 vdc through the **IRCM CONTR** circuit breaker on the No. 2 dc primary circuit breaker panel to the control unit. Panel lighting of the control unit is controlled by the **INSTR LTS NON FLT** control on the upper console. When the control unit **ON-OFF** switch is placed **ON**, the power distribution and control circuits are activated and the ON lamp is lit for about 60 seconds on helicopters prior to Serial No. 78-22987. The source begins to heat, the servo motor and drive circuits are energized, turning on the high and low speed modulators, and a signal is applied to stabilize system operations before energizing the built-in test function. After a warmup period the stabilizing signal is removed, and the system operates normally. Placing the **ON-OFF** control switch momentarily to **OFF** causes the power distribution and control circuits to de-energize the source and initiates a cooldown period. During the cooldown period, the servo motor drive circuits remain in operation, applying power to the motors that cause the modulators to continue turning. The **INOP** light will remain on during cooldown cycle, and on helicopters Serial No. 78-22987 and subsequent, the **IRCM INOP** caution light will be lit. After the cooldown period, the power distribution and control circuits de-energize, all system operating voltage is removed and the **IRCM INOP** caution light, or the **INOP** light, will go off. On helicopters prior to Serial No. 78-22987, if a malfunction occurs during system operation, the **INOP** light on the control unit will go on and the cooldown period will automatically begin. On helicopters Serial No. 78-22987 and subsequent, if a system malfunction causes the **IRCM INOP** caution light on the caution panel to go on, the **IRCM INOP** caution light will remain lit until the control panel **ON-OFF** switch is momentarily placed **OFF**. The system can be returned to operating mode by momentarily placing **ON-OFF** switch **OFF**, then **ON**, provided the cause of the malfunction has cleared. For additional information, refer to TM 11-5865-200-12.

4.8.1 Infrared Countermeasure System Control Panel. Control of the countermeasure set is provided by the operator control panel on the helicopter instrument panel. On helicopters prior to Serial No. 78-22987, the control panel has one switch (**ON-OFF**) and an **ON** indicator light. On helicopters Serial No. 78-22987 and subsequent, only a power **ON-OFF** switch is on the control panel. Power to operate the countermeasure set is supplied from the No. 2 dc primary bus through a circuit breaker, marked **IRCM CONTR**.

4.8.2 Controls and Function. Controls for the AN/ALQ-144 are on the front panel of the control unit. The function of each control is as follows:

CONTROL	FUNCTION
ON-OFF switch	Turns set on and off.
ON indicator light (green) (Helicopters prior to Serial No. 78-22987)	Indicates system is in a 45 to 75 second warmup mode.
INOP indicator light (red) (Helicopters prior to Serial No. 78-22987)	Indicates malfunction has occurred or countermeasure system is in cooldown cycle.
IRCM caution (Helicopters No. 78-22987 and subsequent)	INOP light (Serial No. 78-22987 and subsequent) Indicates malfunction has occurred or the countermeasure system is in cooldown cycle.



The ECM antenna can be extended with the helicopter on the ground if the radar altimeter is turned off or removed from the installation, or the L (LO SET) indicator is set below the radar altimeter indication.

4.8.3 Operation.

1. **ON** and **INOP PRESS TO TEST** indicator light - Press. Indicator light should go on. (On helicopters prior to Serial No. 78-22987.)
2. **ON-OFF** switch - **ON**. Green indicator light should light for 45 to 75 seconds, then go off. (On helicopters prior to Serial No. 78-22987.)

NOTE

If the **INOP** indicator or **IRCM INOP** caution light goes on after the **ON** indicator (helicopters prior to Serial No. 78-22987) goes off, place the power switch **OFF**.

3. **ON-OFF** switch - **ON** (helicopters Serial No. 78-22987 and subsequent).

4.8.4 Stopping Procedure.

ON-OFF switch - **OFF**. The transmitter will continue to operate for about 60 seconds during the cooldown cycle. **INOP** indicator or **IRCM INOP** caution light as applicable should remain on during cooldown cycle.

4.9 ECM ANTENNA SWITCH. [EH]

The ECM antenna switch is a three-position switch on the instrument panel (Figure 2-9), providing control of ECM antenna deployment and retraction. The switch is spring-loaded to center (**OFF**), with positions marked **EXTEND** and **RETRACT**. Normal operation of the switch is as follows:

a. Extend. When the helicopter is on the ground with all systems working properly and the radar altimeter **L (LO SET)** indicator is set above the radar altimeter indication, the antenna cannot be extended because of the interlock system. When the helicopter is in flight, with the copilot's radar altimeter indication above the **L (LO SET)** indicator, the antenna can be extended until it reaches the fully extended position, by momentarily placing the switch to **EXTEND**. Once the extension or retraction process has started, it cannot be overridden with another command from the **ECM ANTENNA** switch. The cycle can be interrupted by turning off the radar altimeter or setting **L SET** bug above radar altitude indication. When the antenna is fully extended, a light on the ECM operator's console marked **ANTENNA DEPLOYED**, will go on. The **ANTENNA EXTENDED** caution light on the caution/advisory panel will not go on when the antenna is extended. It is a condition light rather than an antenna position light.

NOTE

Automatic ECM antenna retraction is controlled by the copilot's radar altimeter **L (LO SET)** indicator when the altimeter is turned on.

b. Retract. If the antenna is extended, the pilot may momentarily select **RETRACT** to return the antenna to the retracted position. The antenna will automatically retract if the helicopter descends below the altimeter **L** indicator setting or a failure occurs in the radar altimeter. When the antenna is fully retracted, the **ANTENNA RETRACTED** status advisory light on the caution/advisory panel will go on and remain on as long as the antenna stays in that position. The **ANTENNA DEPLOYED** and **ANTENNA EXTENDED** lights should be off with antenna retracted. An emergency retract switch accessible to the ECM operator may be used to retract the ECM antenna if a failure occurs in the cockpit retract system. A light next to the switch indicates when the antenna is extended.

c. Emergency ECM Antenna Retract Switch. An emergency ECM antenna retract switch on the antenna relay assembly on the ECM equipment rack, provides a backup mode of retraction of the antenna if a failure occurs in the

cockpit **ECM ANTENNA** switch. To retract, the switch must be held at up until the antenna is fully retracted and the **ANTENNA RETRACTED** advisory light is on.

4.10 COUNTERMEASURES SET AN/ALQ-156(V)2.

EH

Countermeasure set AN/ALQ-156(V)2 consists of Receiver Transmitter RT-1220. Control indicator C-10031, and four each circular horn antenna AS-3650. Antenna locations are illustrated on Figure 3-1. The countermeasures set provides aircraft protection against infrared-seeking missiles by detecting valid targets and sending pulses to flare dispenser M130. Decoy flares are then launched away from the aircraft. Power to operate the countermeasures set is taken from the No. 1 dc primary and No. 1 ac primary buses through circuit breakers located on the copilot's circuit breaker panel (Figure 2-20).

4.10.1 Basic Principles of Operation. Incoming and outgoing RF signals are routed between the circular horn antennas and the receiver transmitter through coaxial cables. The transmit signal is modulated and amplified in the receiver transmitter, and routed alternately to forward and aft antennas. After each pulse transmission, return signals are received by the same antenna used for transmission and routed to the receiver transmitter for processing. When an approaching missile is detected, the countermeasures set sends a pulse to flare dispenser M130. If armed, the flare dispenser launches a decoy flare to draw the missile away from the aircraft.

4.10.2 Controls, Displays, and Functions.

WARNING

During take-off, landing and ground operations, the ALQ-156 POWER switch must be in the OFF position. Failure to comply may cause inadvertent release of flares resulting in personal injury or damage to equipment.

Control indicator C-10131, located on the instrument panel (Figure 2-9) to the right of the ECM ANTENNA switch, contains controls and status indicators for system operation. The control indicator front panel is illuminated by integral lighting. Controls and indicator of C-10131 are shown in Figure 4-1 described below:

**CONTROL/
INDICATOR**

FUNCTION

POWER switch

Places countermeasure set in operate (**ON**) mode. The switch is a positive-locking type and cannot be accidentally shut off. The switch must be pulled out and then down to turn off the countermeasure set.

TEST FLARE switch

Tests ALQ-156/M130 systems and enables test flare launch in **ON** condition. The switch is a momentary depress-release type. It should be used only in conjunction with flare dispenser M130 test procedures.

**PUSH FOR
STANDBY
STATUS** pushbutton

Places countermeasure set in standby or operate mode. When depressed, switch places system in standby mode and upper half of indicator shows STBY. In "out" position, switch places system in operate mode. During initial warmup, lower half of indicator shows WRMUP. After warmup, the indicator is blank to show that the system is on and ready for flare dispense.

4.10.3 Operation. The following procedures shall be followed to operate the countermeasure set:

WARNING

Do not stand within six feet of Aircraft Survivability Equipment (ASE), ALQ-156 and ALQ-162, transmit antennas when the ASE equipment is on. High frequency electromagnetic radiation can cause internal burns without causing any sensation of heat.

When ALQ-156 POWER switch is ON, and the M130 Flare system is armed, a flare can be fired.

1. M130 flare system **ARM/SAFE** switch - **SAFE**.

NOTE

Prior to beginning the turn-on procedure, ensure that the push for standby pushbutton is in the "out" position (not depressed).

2. ALQ-156 **POWER** switch - **ON**. Observe that status indicator shows WRMUP, indicating that receiver transmitter is in warmup mode.

NOTE

The actual length of time that the WRMUP lamp remains on depends upon a combination of equipment operating status and environmental temperature. Under normal operating conditions, and with air temperature about 77°F (25°C), WRMUP lamp will go out in approximately 8 to 10 minutes.

3. Observe that WRMUP lamp goes out, indicating that the receiver transmitter is now in the on condition.
4. **PUSH FOR STANDBY/STATUS** pushbutton - Push once to place the countermeasure set in standby. Subsequent depressions switch the countermeasure set alternately from on to standby.
5. M130 flare system **ARM/SAFE** switch - **ARM** (Figure 4-1).

4.10.4 Stopping Procedure. The following procedure shall be used to turn off the countermeasures set:

ALQ-156 **POWER** switch - **OFF**.

4.11 COUNTERMEASURES SET AN/ALQ-162(V)2.

EH

Countermeasures set AN/ALQ-162(V)2 consists of Receiver Transmitter RT-1377, Control Unit C-11080, and two each antenna AS-3554. Antenna locations are illustrated on Figure 3-1. The countermeasures set provides warning and protection against surface-to-air (SAM) and airborne interceptor missiles (AIM). Missile radar signals are detected by the system, modulated internally, and re-transmitted as false, misleading echoes. Power to operate the countermeasures set is taken from the DC MON and No. 2 ac primary buses through circuit breakers located on the pilot's circuit breaker panel (Figure 2-20), refer to TM 11-5865-229-10.

4.11.1 Basic Principles of Operation. Incoming signals received from SAM and AIM missiles using Continuous Wave (CW) for guidance are validated by the countermeasures set. Depending upon validation results, the system initiates jamming action and/or warns the crew of approaching missiles. Automatic jamming/warning decisions are determined by warning and jamming thresholds pre-programmed in the system. The countermeasures set may be used in stand-alone fashion or in conjunction with AN/APR-39(V)2 Radar Warning Receiver (RWR). The RWR processes and displays threat information. A Built-In Test (BIT) automatically and continually tests systems operations. Malfunctions cause a no-go lamp to light in the control unit front panel. The countermeasures set can be structured to counter different threats by programming the program module assembly in the front of the receiver transmitter. The programming is done before flight by the ground crew, as the receiver transmitter is not within operator reach.

4.11.2 Controls, Displays, and Functions. Located in the center of the lower console, Control Unit C-11080 contains controls and indicators necessary for countermeasures set operation. The control unit is described below:

CONTROL/ INDICATOR	FUNCTION
VOLUME control	Controls tone generator volume. A tone is generated in the aircraft headset immediately upon threat detection.
BIT test switch	Initiates automatic and continuous Built-In-Test of countermeasures set operations.
Lamp test switch	Tests lamp functions of WRMUP, NO GO lamps.
Function switch	Controls countermeasures set operation. OFF removes power from the set. STDY provides warmup power but does not enable transmit-receive circuits. RCV turns on the receiver for maintenance testing of antenna, sensing, and processing circuits. OPR provides full operational power to both receiver and transmitter.

**CONTROL/
INDICATOR**

FUNCTION

Warm up & No Go Lamps Indicates countermeasures set status. WRMUP appears when unit is first turned on and goes out after approximately 3 minutes. NO GO will light if BIT operation detects a system failure.

warmup period is required. Do not attempt operation of the unit until warmup is successfully completed.

3. **WRMUP** lamp - Check that lamp goes out after 3 minutes.

4.11.3 Operation.



When the countermeasures set is operating, electromagnetic radiation is present. **DO NOT OPERATE** if personnel are within six feet of transmit antennas. High frequency electromagnetic radiation can cause internal burns without causing any sensation of heat.

NOTE

A complete operational test consisting of a lamp test, operator-initiated BIT test, and a signal test is incorporated in normal operational procedures. The test shall be performed before flying any mission that requires use of the countermeasures set.

The following procedures shall be used to operate the countermeasure set under usual conditions: OPERATOR-INITIATED BIT TEST

NOTE

Before beginning step 1, turn control unit **VOLUME** control fully clockwise.

1. Control unit function switch - **STBY**. Observe front panel and **WRMUP** lamps light. A tone should be heard briefly in the headset.
2. Lamp test switch - Press and observe all four lamps light in pushbutton switch.

NOTE

If the countermeasures set has been without power for 30 seconds or more, a 3 minute



The countermeasure set will radiate powerful, high-frequency electromagnetic energy when countermeasures set function switch is set to **OPR**. Ensure personnel are at least six feet from antennas while countermeasures set is in operate mode.

4. Control unit function switch - **OPR**.
5. **BIT** switch - Depress. A tone should be heard in the headset.

4.11.4 Stopping Procedure. The following procedure shall be used to turn off the countermeasures set: Control unit function switch - **OFF**.

4.12 HEADS UP DISPLAY AN/AVS-7.

Heads up display (HUD) AN/AVS-7; (Figure 4-7) consists of signal data converter CV-4229/AVS-7 (SDC) located in the avionics compartment, the converter control C-12293/AVS-7 (CCU) located on the lower console, and the display, SU-180/AVS-7 (DU) consisting of the optical unit (OU) and power supply calibration unit (PSCU). Two thermocouple amplifiers are located in the avionics compartment and two **HUD** control switches are located on the pilot's collective sticks. The HUD system serves as an aid to pilots using the AN/AVS-6 (ANVIS) during night flight operations by providing operational symbology information about the aircraft. There are two programming modes and one operational mode which allow both pilots to independently select the symbology for their respective display modes from a master set of symbols in the signal data converter. Power to operate the HUD system is provided by the 26V ac essential bus and the 28V dc bus through circuit breakers marked **HUD REF** and **HUD SYS**.

4.12.1 Basic Principles of Operation. The pilots can independently select from four normal symbology modes and four declutter modes that were pre-programmed. Declutter mode has four vital symbols that will always be displayed: Airspeed, Altitude (MSL), Attitude (pitch and roll), and Engine Torque(s). An adjust mode, during opera-

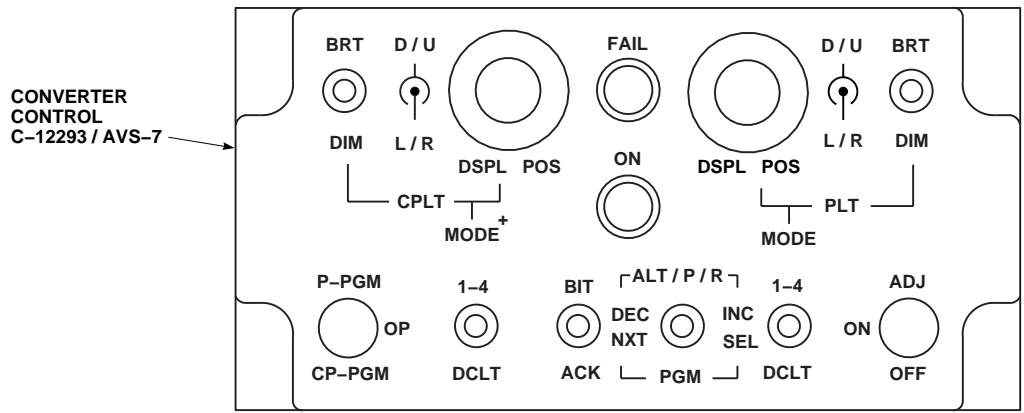
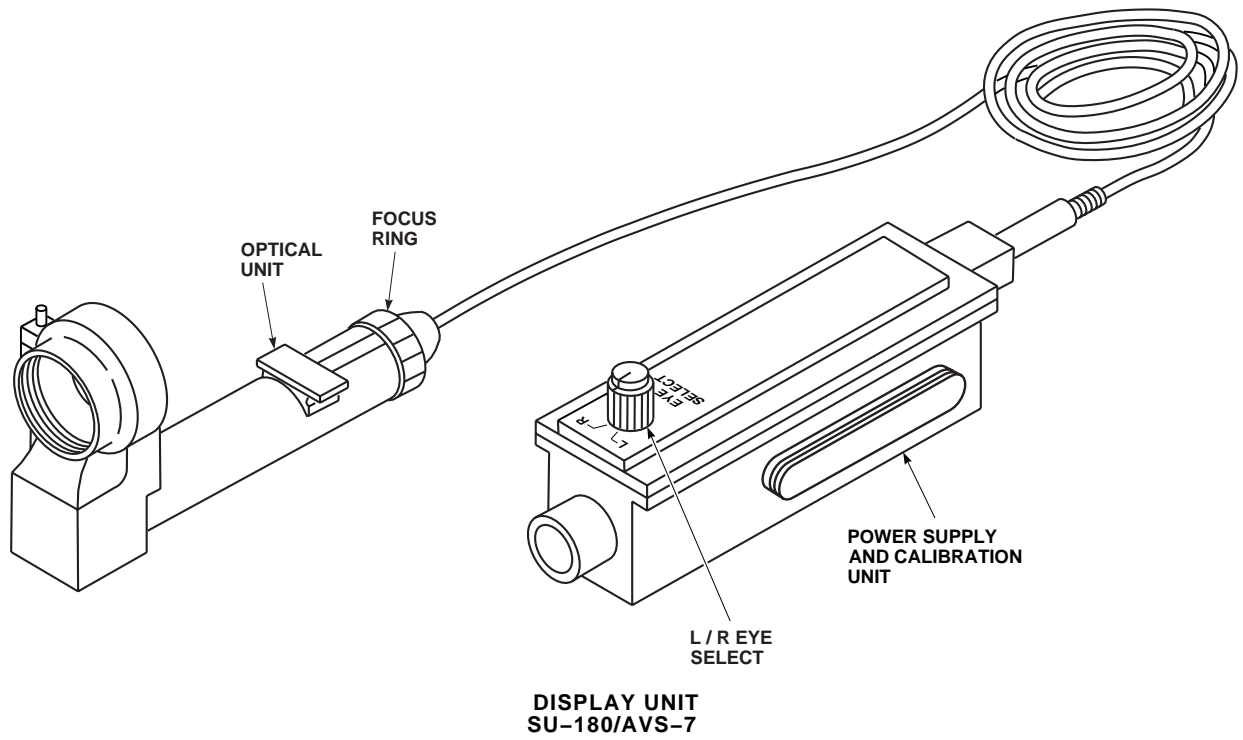

AA9221A
SA

Figure 4-7. Heads Up Display AN/AVS-7

tion, is used to adjust barometric altitude, pitch, and roll. If the HUD system loses operating power after adjustments have been made, the brightness, mode, barometric altitude, pitch, and roll must be adjusted as necessary. The system self test is divided into power-up or operator initialized built-in-test (BIT) and in-flight BIT. The system BIT is initialized during power-up or selected by the operator. Part of the BIT is a periodic test that is performed automatically along with normal system operation. A failure of the SDC, or the pilot's DU will illuminate the CCU **FAIL** light and display a **FAIL** message on the display unit. When a **FAIL** message is displayed on the DU, the operator should acknowledge the failure and re-run BIT to confirm the fault.

4.12.2 Controls and Functions. The CCU, located on the lower console, (Figures 2-8 and 4-7), and the control switches on the pilot's collective stick (Figure 2-14) are controls and indicators necessary for HUD operation. The **EYE SELECT L/R** position is set when display units are connected prior to operation. A focus ring on the OU provides control for focusing the display. The OU is adjusted by the manufacturer and under normal conditions adjustment is not required.

- a. The converter control is described below:

CONTROL/ INDICATOR	FUNCTION
CPLT	
BRT/DIM	Copilot's control for display brightness.
DSPL POS D/U/ L/R	Copilot's control for display position down/up (outer knob) and left/right (inner knob).
MODE 1-4/ DCLT	Copilot's mode select 1-4 and declutter switch.
PLT	
BRT/DIM	Pilot's control for display brightness.
DSPL POS D/U/ L/R	Pilot's control for display position down/up (outer knob) and left/right (inner knob).
MODE 1-4/ DCLT	Pilot's mode select 1-4 and declutter switch.
FAIL	Indicates a system failure.
ON	Indicates system ON.

CONTROL/ INDICATOR	FUNCTION
ADJ/ON/OFF	Selects adjust mode, enabling the INC/DEC switch to adjust altitude, pitch, or roll. Turns power on or off to HUD system.
P-PGM/OP/CP- PGM	Selects pilot program mode, operational mode, or copilot program mode. Used with the PGM NXT/SEL switch.
BIT/ACK	Selects built-in-test or used to acknowledge a displayed fault, completion of an adjustment, or completion of a programming sequence.
ALT/P/R DEC/ INC	Active when adjust mode is selected to decrease/increase altitude/pitch roll. When adjusting altitude (MSL) a momentary movement of the INC/DEC switch will change data in 5 feet increments. When the INC/DEC switch is held for one second data will change 10 foot increments. Pitch and roll change in increments of one degree.

PGM NXT/SEL	Active when program mode is selected. Allows operator to pre-program the four normal modes and four declutter modes. Operator can select a flashing symbol for display and/or go to the next symbol. Once complete, operator toggles the ACK switch to save programmed display.
--------------------	--

- b. Pilot's collective controls are described as follows:

CONTROL	FUNCTION
BRT/DIM	Allows pilot's to control brightness of their respective displays.
MODE/DCLT	Allows pilot's to select respective display modes or declutter modes.

- c. Attach optic unit to either ANVIS monocular housing. Set **EYE SELECT** switch on **PSCU** to **L** or **R**.

4.12.3 Modes of Operation. There are two programming modes and one operational mode for the HUD system selected by the programming switch on the CCU. The adjust mode is a submode under the operational mode.

1. Pilot programming switch - Set to **P-PGM**.
2. Copilot programming switch - Set to **CP-PGM**.
3. Operation (flight mode) switch - Set to **OP**.
(Adjust - **ADJ/ON/OFF** switch to **ADJ**).

4.12.4 Display Modes. Symbology display modes are programmable by the pilots via the converter control lo-

cated on the lower console. Modes are defined by selecting from a master symbology menu (Figure 4-8 and Table 4-1). Up to eight display modes, four normal and four declutter, can be programmed for each user and can be selected for display using the display mode selection switch on the pilot's collective control or on the CCU. The default declutter mode has a minimum symbology display of:

- Airspeed - No. 25.
- Altitude (MSL) - No. 7.
- Attitude (pitch and roll) - No. 1, 5, 6, 20, 26.
- Engine Torque(s) - No. 22, 23.

Table 4-1. UH-60A/L Master Mode Symbology Display (HUD)

No.	Symbol	Source	Range/Description
1	Angle of Pitch Scale	HUD System	± 30° (10° units, tic marks flash when angle of pitch is > ± 30°).
2	Bearing to Waypoint - Pointer	Doppler	0 - 359° (cursor will invert "V" when aircraft is moving away from waypoint).
3	Compass Reference Scale	HUD System	0 - 359° (10° units).
4	Aircraft Heading Fix Index	HUD System	Fixed Reference Mark.
5	Angle of Roll - Pointer	Copilot's Vertical Gyro	± 30° (right turn moves pointer to right, pointer flashes > ± 30°).
6	Angle of Roll - Scale	HUD System	± 30° (10° units).
7	Barometric Altitude (MSL)	Air Data System	-1000 to 20,000 feet (set during adjustment mode).
8	Adjust/Program Message	Mode HUD System	ADJ or PROG .
9	OK/FAIL	HUD System	OK or FAIL .
10	Velocity Vector	Doppler	0 - 15 knots/15 kilometers, 0 - 359°.
11	Rate of Climb Pointer	Air Data System	± 2000 feet-per-minute (used with vertical speed scale, No. 15).
12	Radar Altitude (AGL) - Numeric	Pilot's Radar Altimeter	0 - 1000 feet (0 - 200 feet, 1 foot units; 200 - 1000 feet, 10 foot units; disappears above 999 feet, and reappears below 950 feet).
13	Minimum Altitude Warning	Pilot's Radar Altimeter	Blinking square around symbol - No. 12, (set on pilot's low warning bug).
14	Radar Altitude (AGL) Analog Bar	Pilot's Radar Altimeter	0 - 250 feet (disappears at 250 feet, reappears at 230 feet; digital readout symbol, No. 12).
15	AGL, Vertical Speed Scale	HUD System	0 - 200 feet/± 2000 feet-per-minute.
16	HUD Fail Message	HUD System	CPM, SDR, SDA, PS, PDU, CPDU, NAV, PGM ; can be cleared from the display by selecting ACK (see note).

Table 4-1. UH-60A/L Master Mode Symbology Display (HUD) (Cont)

No.	Symbol	Source	Range/Description
17	Trim (Slide Ball)	SAS/FPS Computer	± 2 balls (left/right).
18	MST, MEM, HOOK Messages	Master Caution Panel	MST, MEM, HOOK cannot be cleared from the display by selecting ACK .
19	Sensor, Engine, Fire, RPM Warnings	Master Warning Panel	ATT, ENG 1 or 2, FIRE, RPM; ATT can be cleared from the display by selecting ACK (see note). ENG, FIRE, and RPM cannot be cleared.
20	Horizon Line (pitch, roll)	Copilot's Vertical Gyro	Pitch: ± 30° Roll: 0 - 359°.
21	Display Mode Number	HUD System	1N - 4N for normal modes, 1D - 4D for declutter modes.
22	Torque Limits	Torque Transducer	0 - 150% Yellow (>100%), (solid box) Red (>110%) Thresholds (solid box flashes).
23	Torque - Numerics	Torque Transducer	0 - 150% (flashes when engine torque separation is greater than 5% threshold) Maximum % torque split between cockpit panel and HUD is 3%.
24	Ground Speed	Doppler	0 - 999 knots/0 - 530 km/h (dependent on doppler).
25	Indicated Airspeed	SAS/FPS Computer	30 - 180 knots (no symbol 30 knots and below, reappears at 32 knots).
26	Attitude Reference Indicator	HUD System	Represents helicopter.
27	Engines Temperature	Thermocouple Amplifiers	0 - 999°C (0 - 755°C - 999°C, 1° units) Maximum split between cockpit and HUD is ± 15°.
28	Distance to Waypoint	Doppler	0 - 999.9 km.
29	Bearing to Waypoint - Numeric	Doppler	0 - 359°

NOTE: After **ACK** is used to acknowledge a fault, the fault will not reappear until BIT is selected or power is cycled off and on.

4.12.5 Operation.

4.12.5.1 Starting Procedure.

1. **ADJ/ON/OFF** switch - **OFF**.
2. Optical unit support clamps - Installed on ANVIS. Verify clamps can be rotated.

NOTE

Check surface of lens for cleanliness. Clean in accordance with TM 11-5855-300-10.

3. DU lens - Check.



Failure to remove the ANVIS neck cord prior to operation of the HUD may prevent egress from the aircraft in an emergency.

4. ANVIS neck cord - Removed.
5. Optical unit - Install on ANVIS. Attach optical unit to either monocular housing. Do not tighten OU clamp completely with thumbscrew

at this time. The OU (display) may have to be rotated to horizon after the system is operating.

NOTE

The helmet may now have to be rebalanced.

6. **EYE SELECT** switch on PSCU - **L** or **R**.



CCU ADJ/ON/OFF switch must be OFF before connecting or disconnecting quick-release connector.



The AN/AVS-7 system should not be used if the quick-release connector is not in working order.

7. PSCU - Connect. Connect PSCU to quick-release connector by rotating the connector engagement ring.



Keep the protective caps on the ANVIS whenever it is not in use. Operate the ANVIS only under darkened conditions.

NOTE

Ensure ANVIS operator procedures have been completed.

8. **P-PGM/OP/CP-PGM** switch -**OP**.
9. **ADJ/ON/OFF** switch - **ON**. System **ON** and **FAIL** lights illuminate and BIT will initiate automatically.
10. **FAIL** light - Check. Light should go out after ten seconds. BIT is complete.

NOTE

Allow one minute for display warm-up. Display intensity is preset to low each time

ADJ/ON/OFF switch is set from **OFF** on **ON**.

If a fault is displayed in the DU, acknowledge fault and re-run BIT to confirm fault.

11. **BRT/DIM** switch - As desired.
12. **DSPL POS** control - As required. Center display in field of view.
13. Display aligned to horizon - Check. Tighten OU clamp.

4.12.5.2 Operator Self Test (BIT).

1. **BIT/ACK** switch - Press to **BIT** and hold. The **ON** and **FAIL** light will illuminate. At end of BIT, **FAIL** indicator will extinguish.
2. **BIT/ACK** switch - Release.

4.12.5.3 Displayed System Faults. The system self test is divided into power-up or operator initialized built-in-test (BIT) and inflight BIT. The faults result as warnings and messages that blink at a rate of two per second in the display units. Part of the BIT is a periodic test that is performed automatically along with normal system operation. This BIT monitors and/or tests SDC functions and/or signals. A failure of the SDC, NAV signals pilot's DU, will illuminate the converter control **FAIL** light and display a FAIL message **CPM, SDR, SDA, PS, NAV, PDU** or **CPDU** on the display unit. An attitude (ATT) sensor indication will be displayed when a gyro invalid condition exists. **ATT, NAV, PDU, CPDU**, and all SDC faults can be cleared by setting **BIT/ACK** switch to **ACK**. The following helicopter status messages are also displayed.

1. The caption **MST** (first priority) indicates operation of the master caution warning lamp. This message will disappear during the rest of the main warning lamp operation.
2. The caption **MEM** (second priority) indicates that the doppler data is not updated. a previous computed data is available. This message will appear simultaneously with the **MEM** lamp on the doppler operating panel.
3. The caption **HOOK** (third priority) indicates the cargo hook is open.

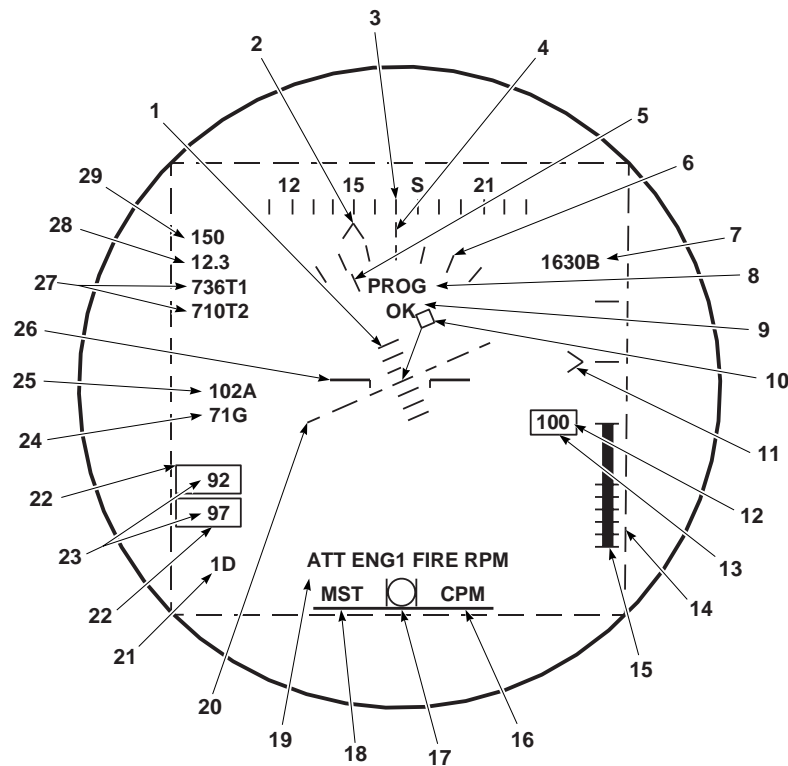

AA9222
SA

Figure 4-8. Master Mode Display

The message will appear simultaneously with the indication lamp in the cockpit.

Setting **BIT/ACK** switch to **ACK** will not clear **MST**, **MEM**, or **HOOK** status messages from the DU. Engine, **FIRE** and **RPM** warnings cannot be cleared from the DU. The faulty unit or warning must be removed from the aircraft. When both engines fail at the same time, engine priority is: **ENG 1** then **ENG 2**.

4.12.5.4 Programming Procedure.

NOTE

The programming procedure for the pilot and copilot is identical except for the location of controls on the CCU.

1. Select mode to be programmed (**1N-4N**). The first mode that will appear is **1N** (normal mode 1).
2. **P-PGM/CP-PGM/OP** switch - **P-PGM** or **CP-PGM**.
3. **PROG** blinking in display - Check. Verify that a complete set of symbology is displayed and

attitude reference symbol is blinking. Verify **PGM** is displayed in the **HUD FAIL** message location for the DU not being programmed.

4. **BIT/ACK** switch - **ACK** to program the full display or go to step 5 and select desired symbols.
5. **PGM SEL/NXT** control - **SEL** to select symbol. Selected symbol stops blinking. If symbol is not desired, toggle switch to **NXT** and the symbol will disappear.

NOTE

All symbols have been programmed when the **PROG** annunciator is the only symbol flashing.

6. **BIT/ACK** switch - **ACK**. (Hold switch to **ACK** for one second.)
7. **OK** displayed - Check. (**OK** will be displayed for two seconds.)

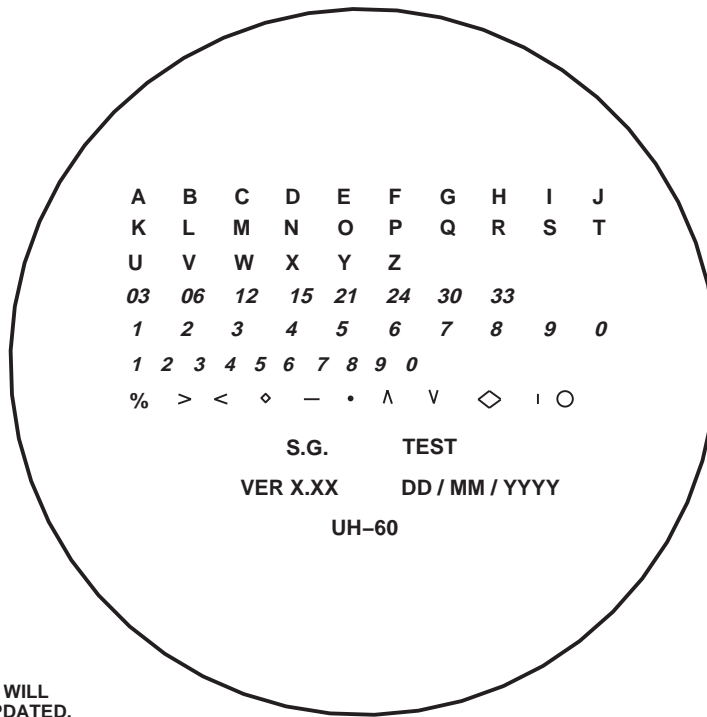

NOTE

VERSION NUMBER AND DATE WILL CHANGE AS SOFTWARE IS UPDATED.

AA9223
SA

Figure 4-9. Symbol Generator Test Mode

NOTE

If programming is not accepted, **FAIL** will be displayed. If a **FAIL** message is displayed, attempt to reprogram the same mode, if **FAIL** reappears notify maintenance.

Declutter mode is recognized by flashing ground speed indicator in lieu of attitude reference symbology.

- 8. **MODE 1-4/DCLT - DCLT (1D-4D)**. The first **DCLT** mode that will appear is **1D** (declutter mode 1).

NOTE

If **MODE 1-4/DCLT** switch is toggled to **DCLT** a second time the display will cycle back to the **DCLT**'s normal mode (**1N-4N**). The **MODE 1-4/DCLT** switch must be set to **MODE 1-4** to advance to another normal mode.

- 9. Repeat steps 4 through 7, for declutter.

- 10. **MODE 1-4/DCLT** switch - As required.

- 11. Repeat steps 4 through 10 until all desired modes are programmed.

- 12. **P-PGM/CP-PGM/OP** switch - **OP**.

4.12.5.5 Adjustment of Barometric Altitude, Pitch, and Roll.



An improperly adjusted barometric altimeter will result in an improperly set HUD barometric altitude display.

NOTE

Barometric altimeter should be set to the most current altimeter settings, field elevation.

- 1. Ensure **P-PGM/CP-PGM/OP** switch is in the **OP** position.

2. **ADJ/ON/OFF** switch - Pull and set to **ADJ**.
3. **ADJ** blinking in display - Check.

NOTE

Changes to barometric altimeter settings require a corresponding change to the HUD barometric altitude. Each .01 inch change in pressure equals 10 feet.

4. **INC/DEC** switch - As required.
5. **BIT/ACK** switch - **ACK**.
6. Repeat steps 3 through 5 for pitch and roll.
7. **ADJ/ON/OFF** switch - **ON**.

4.12.5.6 In-flight Operation.

WARNING

Whenever the symbology displayed in the DU is suspected of being incorrect the pilot's will compare the data with the aircraft instrument indicator and take the appropriate action.

Excessive brightness of the symbology display may impair vision outside the cockpit.

Interruption of electrical power, such as change over from APU generator to NO. 1 and NO. 2 generators and vice versa, will cause DU to default to dim and MODE 1N. Any adjustments made to the barometric altitude, pitch and roll prior to flight will be lost, thereby decreasing the accuracy of the barometric altitude, pitch and roll.

1. **BRT/DIM** switch - As desired.

NOTE

Whenever the symbology is interfering with the outside visibility, decluttering may be selected to remove symbology.

2. **MODE 1-4/DCLT** switch - As desired.

4.12.5.7 System Shutdown Procedure.

1. **ADJ/ON/OFF** switch - **OFF**.
2. Turn off ANVIS.

WARNING

CCU ADJ/ON/OFF switch must be OFF before connecting or disconnecting quick-release connector.

Do not disconnect DU by pulling on the cable connected to the PSCU. The DU could be damaged or the cable may separate from the PSCU creating an explosive atmosphere hazard.

Do not attempt to egress the aircraft without performing disconnect as this may result in neck injury.

CAUTION

Do not disconnect DU by pulling on the cable. To do so may damage the DU.

3. Display unit - Disconnect. Disconnect DU by grasping the PSCU and rotating the quick-release connector engagement ring and pull downward. Remove OU and remove from the ANVIS and place into storage case.
4. Reattach neck cord to ANVIS.

4.12.5.8 Emergency Egress. The quick-release feature allows you to exit quickly from the aircraft in an emergency without:

- a. Damaging or turning the unit off.
- b. Getting tangled in cords.
- c. Being restrained in the cockpit by hardwired connections.
- d. Removing ANVIS.

It is up to the operator to determine the desired mode of disconnect based upon his evaluation of the emergency

condition and whether or not the ANVIS goggles will be needed following egress. The available means of disconnect are as follows:

- a. Release the ANVIS goggles from the helmet.
- b. Disconnect the OU from the ANVIS goggles via the thumbscrew.
- c. Grasp PSCU and pull down.

4.13 ASE STATUS PANEL. EH

The ASE status panel (Figure 4-10) is designed to integrate several ASE indicator lights (for various ASE systems installed) into one location and also tie those status lights to the **MASTER CAUTION** light and the caution/advisory panel. The status panel provides status lights for three ASE systems currently designated to be installed, and two blank slots for expansion.

CONTROL/ FUNCTION	INDICATOR
NO GO	Lights if the AN/ALQ-162 R/T fails self-test.
CW THRT	Lights if the AN/ALQ-162 detects a continuous wave (CW) threat radar.
CW JAM	Lights if the AN/ALQ-162 is being jammed.

NOTE

Only a **NO GO** light will trip the **ASE** caution light on the caution/advisory panel and the **MASTER CAUTION** light.

**CONTROL/
FUNCTION**

INDICATOR

AN-ALQ-156

CM JAM

Lights if the AN/ALQ-156 is being jammed.

CM INOP

Lights if the AN/ALQ-156 R/T fails self-test.

NOTE

Only a **NO GO** light will trip the **ASE** caution light on the caution/advisory panel and the **MASTER CAUTION** light.

AN/ALQ-144

IRCM INOP

Lights if the AN/ALQ-144 R/T fails self-test.

NOTE

This condition will trip both **ASE** caution light on the caution/advisory panel and the **MASTER CAUTION** light.

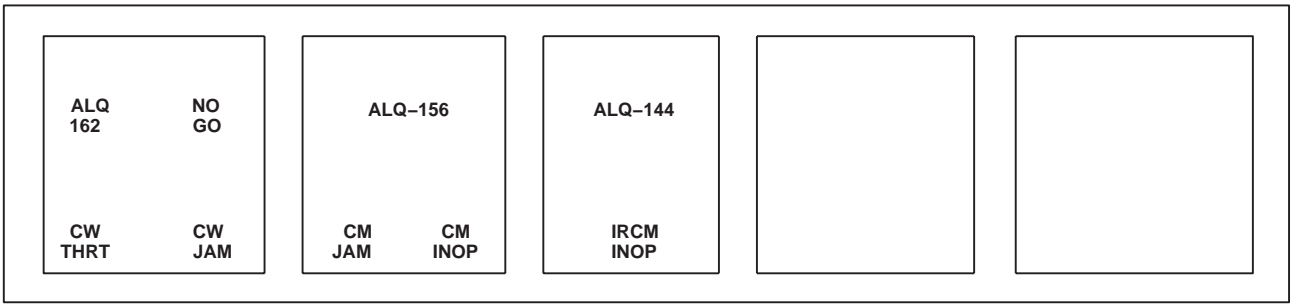

AA1305
SA

Figure 4-10. ASE Status Panel **EH**

Section II ARMAMENT

4.14 ARMAMENT SUBSYSTEM.

The subsystem is pintle-mounted in each gunner's window at the forward end of the cabin section (Figure 4-11). The two M60D 7.62 millimeter machineguns are free-pointing but limited in traverse, elevation, and depression field of fire. Spent cartridges are collected by an ejector control bag on the right side of the weapon. An ammunition can assembly is on the left side, refer to TM 9-1005-224-10.

4.15 MACHINEGUN 7.62 MILLIMETER M60D.

The machinegun (Figure 4-12), is air-cooled, gas-operated and automatic. It uses standard 7.62 mm ammunition (Table 4-2). Headspace is fixed to permit quick change of barrels. Designed primarily for operation in the air, the M60D has an aircraft ring-and-post sighting system. The weapon is pintle-mounted and is held by a quick-release pin. The weapon mount is on a rotating arm assembly which allows the weapon to be locked outboard in the firing position, or stowed inside the aircraft when the rotating arms are locked in the inboard position. It is easily removed from the helicopter and can be used for ground defense with the bipod extended. For more detail of the M60D, refer to TM 9-1005-224-10.

4.15.1 Controls. Controls for the M60D are on the weapon and consist of: barrel lock lever, safety, cocking handle, cover, latch grip and trigger and magazine release latch.

4.15.1.1 Barrel Lock Lever. The lever (Figure 4-12) is at the right front of the receiver. It is attached to the barrel locking shaft and turns to lock or unlock the barrel assembly.

4.15.1.2 Safety. The safety (Figures 4-12 and 4-13), at the lower front of the receiver, consists of a cylindrical pin with a sear clearance cut which slides across the receiver to block the sear and prevent firing. The ends of the pin are marked **S** (safe) and **F** (fire). The exposed letter shows the operating state of the weapon.

4.15.1.3 Cocking Handle. The handle (Figure 4-12), at the right front of the receiver, is used to manually cock the weapon.

4.15.1.4 Cover Latch. The latch (Figure 4-12) is at the right rear side of the cover assembly. When the latch lever

is vertical it locks the cover in the closed position. When moved to the horizontal it unlocks the cover.

4.15.1.5 Grip and Trigger Assembly. The assembly (Figure 4-12) at the rear section of the receiver, includes the spade grips. The U-shaped trigger design permits the weapon to be fired by thumb pressure from either hand.

Table 4-2. Authorized Ammunition

7.62mm:	NATO M59, Ball
7.62mm:	NATO M61, Armor pierce
7.62mm:	NATO M62, Tracer
7.62mm:	NATO M63, Dummy
7.62mm:	NATO M80, Ball

4.15.1.6 Magazine Release. The magazine release latch (Figure 4-12) is on the left side of the receiver. The latch spring automatically locks when the ammunition box is seated on the magazine bracket. Pressing the release latch manually releases the ammunition box.

4.15.2 Installation of Machinegun M60D.



The RS 890224 pintle mount stop must be installed in its proper position if the external stores support system (ESSS) is installed. The stop is a three-position stop: stow, wings only, and external tanks. The stow and wings only positions are independent of aircraft side. The external tanks position is particular to the aircraft side. Care must be taken to ensure the correct position and/or side is installed. Use of the M60D machineguns is prohibited when external ERFS tanks are installed on the inboard vertical pylon.

1. Install one machinegun M60D on the right side and one on the left side of the helicopter at the crew chief/gunner's stations.

2. Attach gun to pintle with quick-release pin, and safety by passing a plastic tie or 0.032-in. safety

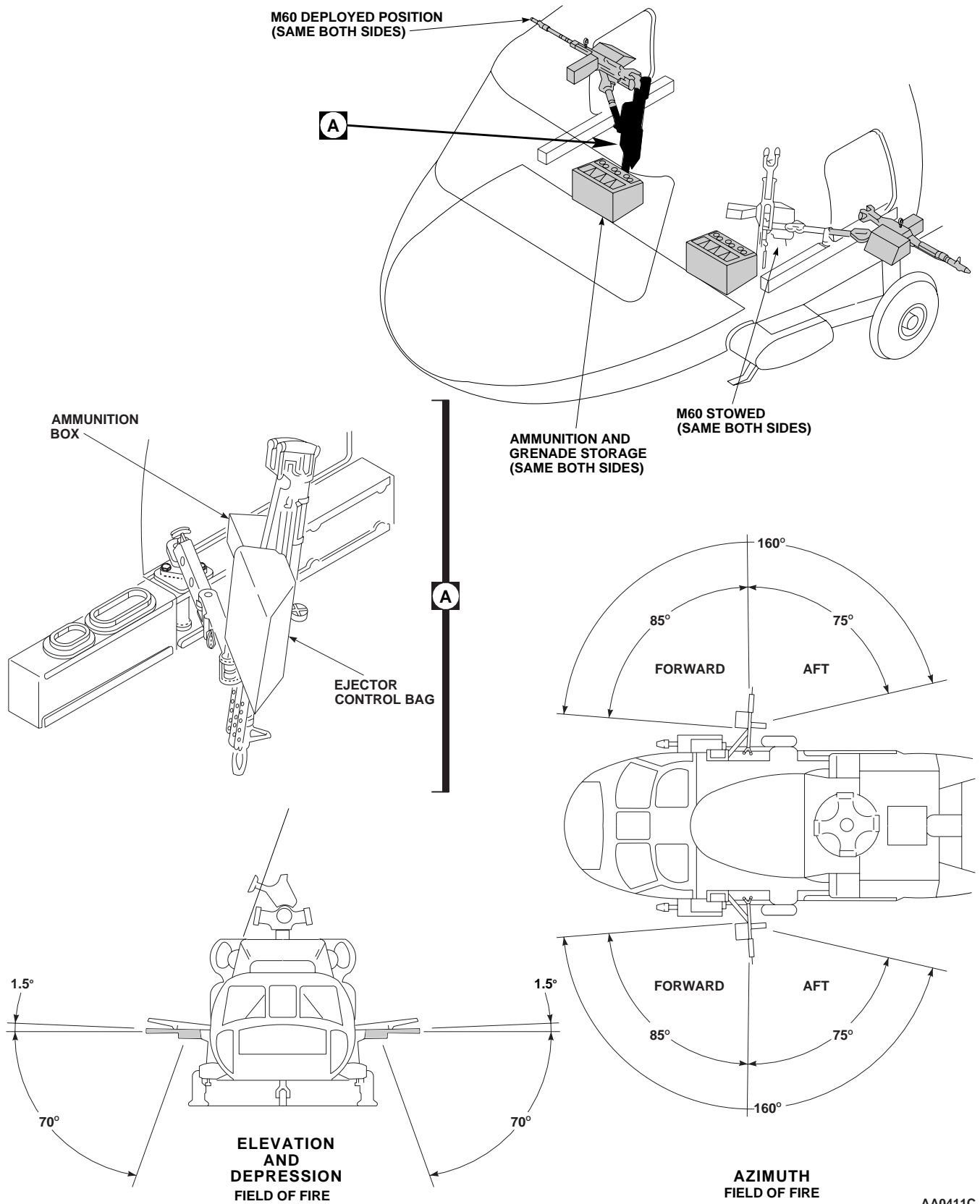

AA0411C
SA

Figure 4-11. Machinegun M60D Installation

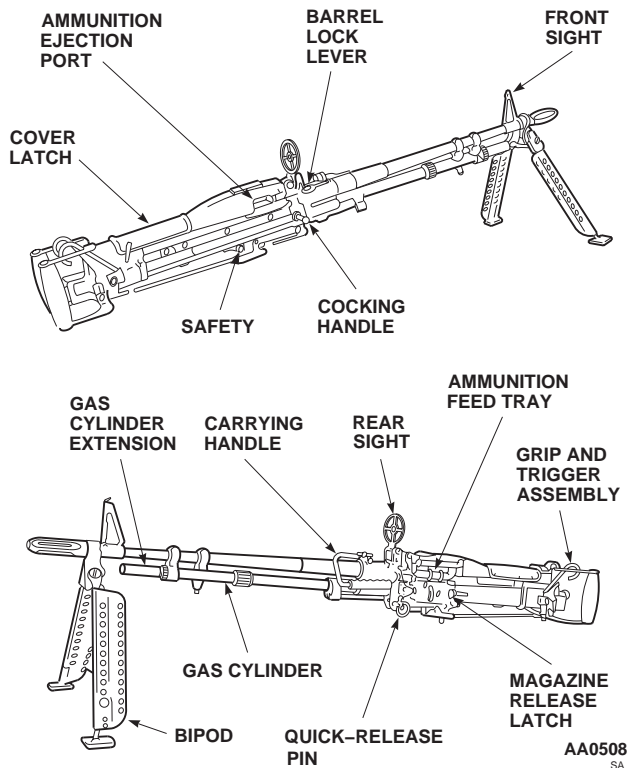

Figure 4-12. Machinegun 7.62 Millimeter M60D

wire through quick-release ring and around the pintle (Figure 4-14).

3. Check that each gun moves freely in azimuth and can be depressed.
4. Removal of gun is reverse of installation.

4.15.3 Installation of Ejector Control Bag.

1. Position bag on right side of gun (Figure 4-15).
2. Position forward arm bracket of bag in front of matching forward mounting point on gun adapter. At the same time, press down on rear bracket safety latch lever. Slide bag basket rearward on mounting points and plate.
3. Position rear bracket of bag behind mounting plate on bottom of receiver.
4. Release latch to lock bag in place.
5. Check bag for positive attachment to gun.

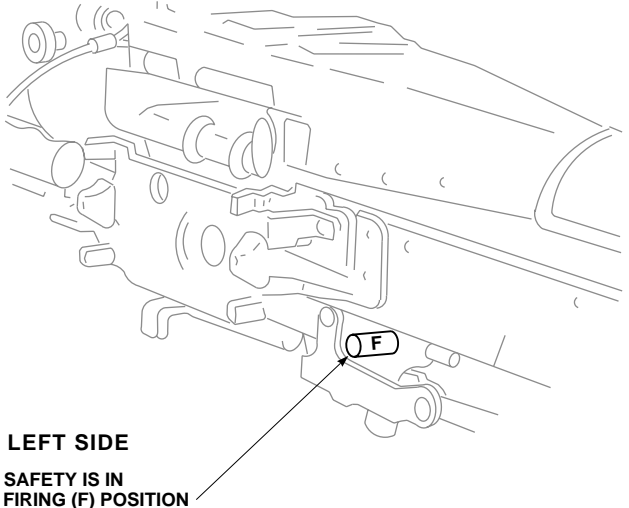
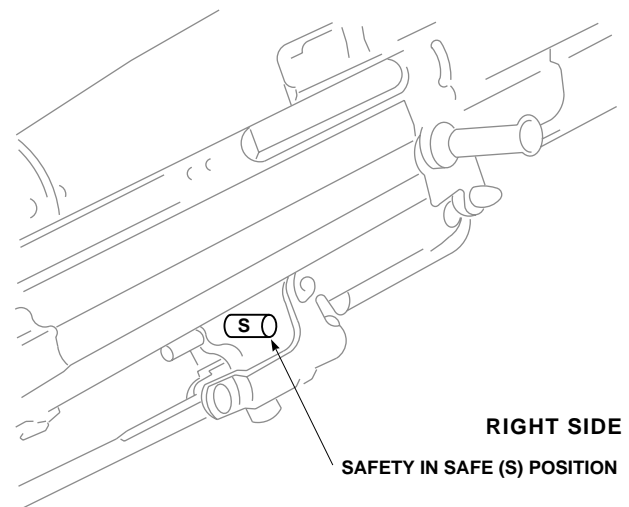

Figure 4-13. Location and Identification of Safety on Machinegun M60D

6. Removal of ejector control bag is reverse of installation.

4.15.4 Installation of Ammunition Can.

1. Open release latch and install can assembly (Figure 4-16).
2. Check that latch makes positive lock, holding can in place.

TO INSTALL: POSITION MACHINE GUN MOUNTING BRACKET IN PINTLE AND SECURE WITH MOUNTING PIN

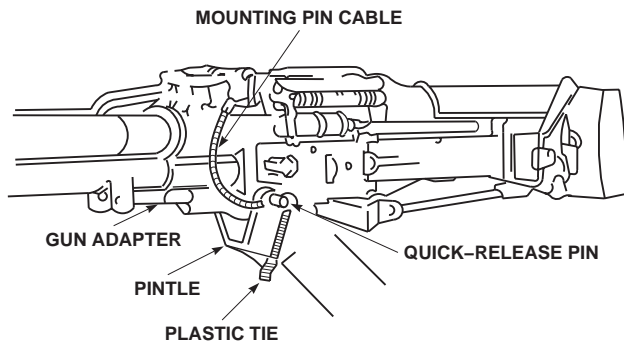

AA0506
SA

Figure 4-14. Installation of Machinegun M60D on Pintle

3. Removal of ammunition can is reverse of installation.

4.15.5 Loading Ammunition.

WARNING

Observe all safety precautions for uploading ammunition in accordance with TM 9-1095-206-13.

1. With ammunition can installed, retract bolt fully.
2. Press safety button to (S) position.
3. Open latch and raise cover assembly.
4. Insert link belt with open side of links down on tray assembly (Figure 4-17).
5. Close cover and latch in place.

4.15.6 Cocking Machinegun M60D.

WARNING

To prevent accidental firing, do not retract bolt and allow it to go forward if belted ammunition is in feed tray, or a

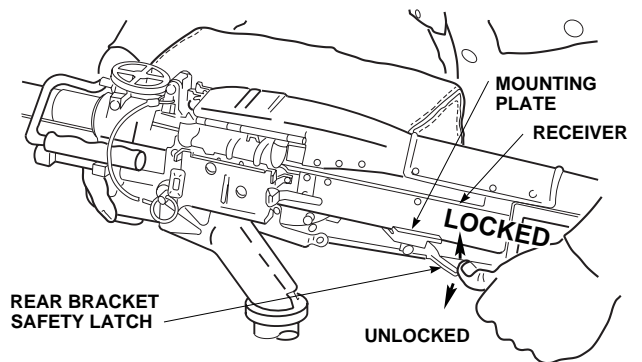
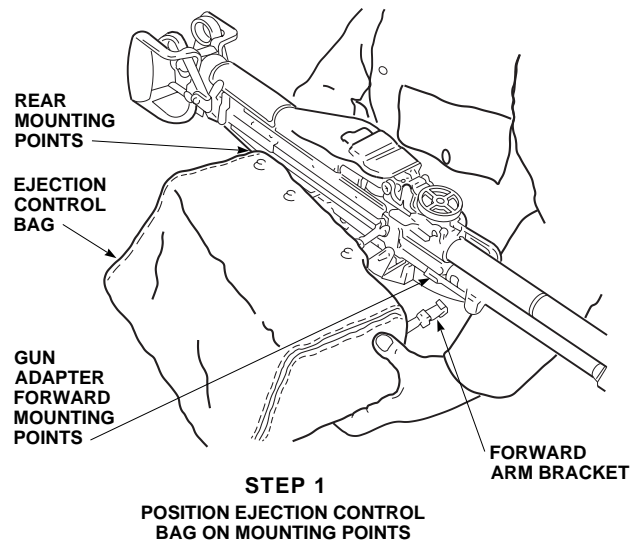

AA0505
SA

Figure 4-15. Installation of Ejector Control Bag on Machinegun M60D

live round is in chamber. Move cocking handle forward by hand.

1. Open ejector control bag and pull cocking handle fully to rear (Figure 4-18).

WARNING

Cocking handle assembly must be returned to full forward (locked) before firing.

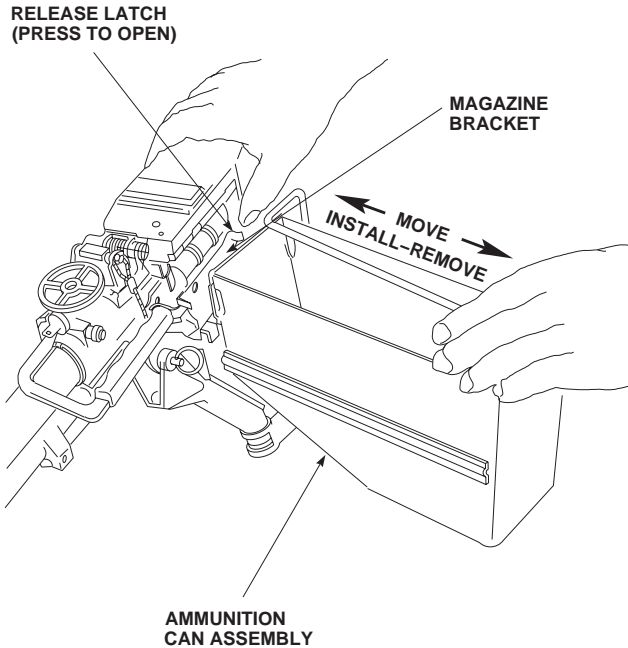

AA0693
SA

Figure 4-16. Installation and Removal of Ammunition Can on Machinegun M60D

2. Move cocking handle full forward to locked position.
3. Press safety button to (S) position (Figure 4-13).

CAUTION

Do not fire machinegun unless the ejector control bag is mounted in place.

4. With machinegun M60D positioned, loaded, and aimed, push safety button (Figure 4-13) to firing (F) position.
5. To fire gun automatically, press trigger fully and hold. See Figure 4-11 for field of fire.
6. Low cycle rate of fire of machinegun M60D allows firing of single rounds or short bursts. Trigger must be completely released for each shot.

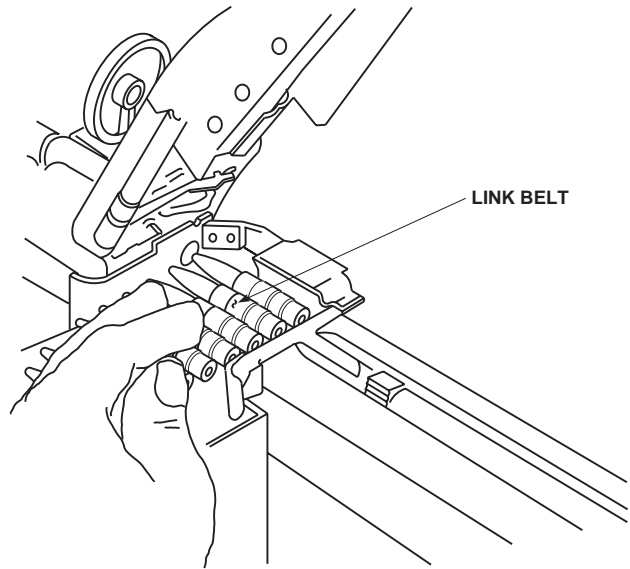

AA0503
SA

Figure 4-17. Positioning Cartridge Link Belt on Machinegun M60D

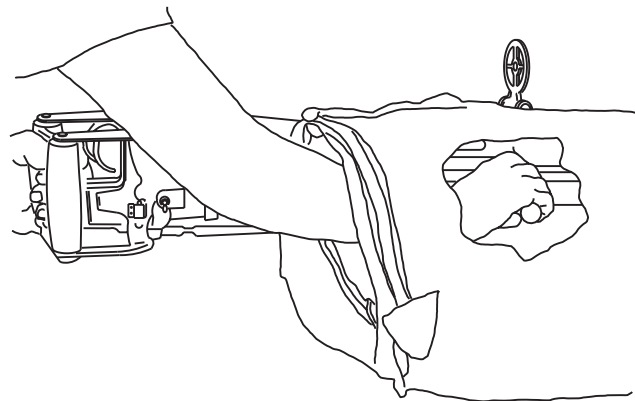

AA0504
SA

Figure 4-18. Charging (Cocking) Machinegun M60D

NOTE

When ammunition is exhausted, the last link will remain in tray assembly. The link assembly can be removed by hand after the cover assembly is opened for loading.

4.15.7 Firing Malfunctions.

WARNING

If a stoppage occurs, never retract bolt assembly and allow it to go forward again without inspecting chamber to see if it is clear. Such an action strips another cartridge from belt. If an unfired cartridge remains in the chamber, a second cartridge can fire the first and cause injury to personnel and/or weapon damage.

- a. Misfire. This is a complete failure to fire. It must be treated as a hangfire until this possibility is eliminated.
- b. Hangfire. This is a delay in functioning of the propelling charge. Time intervals set out in paragraph 4.15.8 must be observed after a failure to fire.
- c. Cookoff. This is firing of the chambered cartridge from a hot barrel. A cookoff may occur from 10 seconds to 5 minutes after cartridge has been in contact with barrel.
- d. Runaway Gun. If gun continues to fire after trigger has been released, grasp belt, twist and break belt, allowing the gun to run out of ammunition (usually when the belt is broken only 3 to 5 rounds will remain).

4.15.8 Failure to Fire Procedure.

1. If a stoppage occurs, wait 5 seconds. Pull handle assembly to rear, making sure operating rod assembly is held back.
2. If cartridge ejects, return handle assembly forward, re-aim machinegun, and attempt to fire. If machinegun does not fire, it must be cleared.
3. If cartridge does not eject, retract bolt assembly. Move safety button to SAFE (S), position. Remove ammunition and links and inspect receiver assembly. Move safety button to FIRING (F) and attempt to fire. If cartridge does not fire and barrel is considered hot enough to cause a cookoff (200 rounds fired within 2 minutes), wait 15 minutes with bolt assembly in forward position. Remove cartridge and reload. If weapon is not hot enough to cause a cookoff, disregard 15-minute wait.

4.15.9 Extracting a Ruptured Cartridge Case. Position ruptured cartridge case extractor in chamber. Run

cleaning rod through barrel assembly from muzzle end. Tap cleaning rod against extractor until extractor and ruptured cartridge case come out of chamber.

4.15.10 Double Feeding. When a stoppage occurs with bolt assembly in forward position, assume there is an unfired cartridge in chamber. Treat this as a hangfire (paragraph 4.15.7).

4.15.11 Unloading. Raise cover assembly and remove linked cartridges. Inspect chamber.

4.15.12 Ammunition. Ammunition for the machinegun is connected to form a link belt; the rounds are used to hold two links together. When a round is fired, the cartridge and link separate and is contained in the ejector bag assembly. Ammunition stowage in the cabin has compartments for six grenades and extra rounds of ammunition.

4.16 VOLCANO MULTIPLE MINE DELIVERY SYSTEM. VOL

The volcano system is an automated, scatterable mine delivery system that is capable of launching mines from the helicopter. The system can dispense mines during day/night and all weather conditions. The system can lay a mine field of up to 960 mines at an average density of 0.9 mines per meter front. For a more detailed description of the volcano system, refer to TM 9-1095-208-23-2&P.

NOTE

The forward two-thirds of the cabin entry/exit doors are restricted by the volcano system making the loading and unloading of passengers and cargo more difficult. Internal loads should be planned accordingly.

4.16.1 System Components. The volcano system consists of five major components: dispenser control unit (DCU), launcher racks, jettison system, aircraft mounting hardware, interface control panel (ICP) and ammunition mine canisters.

4.16.1.1 DCU. The DCU (Figure 4-19) is the primary electronic component and houses the electronics that control the system and contains a control panel for operating the system. An interface control panel (ICP) is provided to connect the applicable controls to the DCU. The DCU controls firing signals to the canisters and conducts built-in testing (BIT) of the entire mine dispensing system. The DCU is the main operator interface for the system. On the DCU TOP panel, the operator controls the system with the following controls:

- a. **POWER** switch.
- b. **SELF DESTRUCT TIME** control.
- c. **HELICOPTER DELIVERY SPEED** control.
- d. **FIRE CIRCUIT ENABLE** switch.
- e. **DIM** control.
- f. **FAILURE INDEX** switch.
- g. **TEST/OVERRIDE** switch.

From the DCU panel the operator also oversees system status with the **SYSTEM FAILURE IDENTIFICATION/TEST** displays. Power to operate the volcano system is provided from No. 1 dc primary bus through the **CMD CSL SET** circuit breaker.

4.16.1.2 Launcher Rack Jettison System. The jettison system consists of an interface panel, emergency and primary jettison circuits, and explosive cartridges. Jettison capability is provided for upper and lower launcher racks on each side of the helicopter. The one shot jettison circuits are independent of each other and either may be used to jettison the launcher racks. Upon activation of **JETTISON** or **EMER JETTISON**, the lower racks on each side will separate from the helicopter. After a lower racks away signal is received by the upper racks, the upper racks will automatically jettison. The **EMER JETTISON** is a backup for the **JETTISON** and provides the same launcher rack jettison function on an independent circuit. When the helicopter is on the ground, the weight-on-wheel switch disables the jettison circuits to prevent unintentional jettisoning of the racks. Power for the jettison system is provided from the dc essential bus through the **ESSS JTSN OUTBD** and **ESSS JTSN INBD** circuit breakers. Power for emergency jettison is supplied by the battery.

4.16.1.3 Interface Control Panel (ICP). Controls and indicators for the ICP (Figure 4-19) are on the control panel and are as follows:

CONTROL/ INDICATOR	FUNCTION
EMER JETTISON/ JETTISON switch	Jettison all launcher racks with canisters.

CONTROL/ INDICATOR	FUNCTION
VOLCANO ARM switch	Arms system.
ARMED light	Illuminates when VOLCANO ARM switch is pulled out and moved up if canisters are loaded and system is enabled. Light will go out when switch is pulled out and moved down.
Flashing ARMED light	Indicates arm enable or launch switch error (GA) or all canisters have been dispensed.
JETTISON TEST/ ARMED switch indicator	Press to start/stop jettison system self-test.
P	Illuminates if jettison system passes test.
F	Illuminates if jettison cartridges are missing.
Flashing F	Indicates one of the following malfunctions: <ul style="list-style-type: none"> -Weight-on-wheels switch. -EMER JETTISON switch. -JETTISON switch. -Missing rack sensor(s).

NOTE

VOLCANO ARM function is independent of **EMER JETTISON** and **JETTISON** function.

4.16.2 Volcano Operational Check.



This operation will be completed only when helicopter is on the ground.

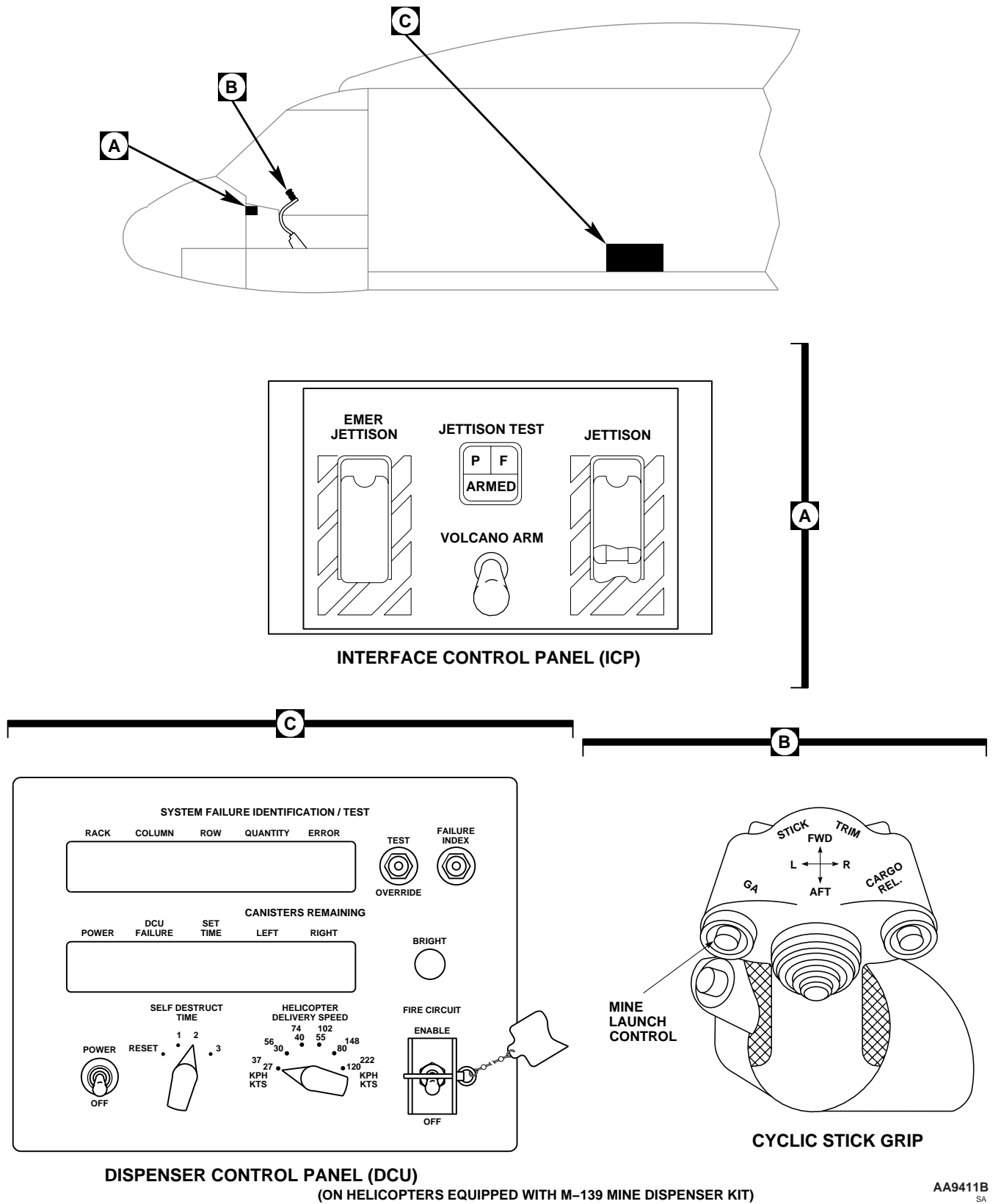

Figure 4-19. Volcano Mine Dispenser Controls **VOL**

AA9411B
SA

NOTE

If, for any reason prior to a mission, DCU is turned **OFF** or loses power, redo steps 2 through 5.

DCU must warm up for two minutes prior to mine laying operation.

DCU will not function if backup hydraulic pump is in operation.

1. Install mine canisters (TM 1-1520-237-23).
2. Toggle DCU **POWER** switch to **POWER**. BIT runs automatically. **POWER** indicator displays **ON**. Other indicators displays 8s or 88s except **DCU FAILURE** display, which will flash **F**. All displays, except for **POWER** are then blank (Figure 4-20).
3. Displays automatically go blank followed by 88s being displayed in left and right **CANISTERS REMAINING** displays. If an error code appears in **ERROR** display, refer to TM 9-1095-208-23-2&P.

NOTE

The following assumes a full canister load. Any load other than 80 canisters each side should result in the number of canisters loaded being displayed instead of 80 after overriding the applicable number of error code "9's" for empty canister slots.

4. Toggle **TEST/OVERRIDE** switch to **TEST**. Canister test is initiated. Canister test is complete when 80s are displayed in **CANISTERS REMAINING** readout and no error code appears. If an error code appears in **ERROR** display, refer to TM 9-1095-208-23-2&P.

NOTE

Error codes 5, 8 and 9 may be overridden. Refer to TM 9-1095-208-23-2&P.



Check SET TIME display to make sure number set with dial is displayed in indi-

cator, otherwise, mines may be launched with a false self-destruct time.

5. **SELF-DESTRUCT TIME** indicator flashes after 15 seconds. Set self-destruct time by turning **SELF-DESTRUCT** switch to **RESET** position for minimum of two seconds, and then to the desired **1, 2 or 3** setting. The set time display must agree with **SELF-DESTRUCT** switch position. If not, repeat procedure. If wrong indication appears again, postpone mission and return to maintenance.
6. Repeat step 5. to reset or change the self-destruct times.

NOTE

If flashing **1** continues to appear in DCU indicator, repeat setting self-destruct time.

7. Set planned dispensing helicopter ground speed with **HELICOPTER DELIVERY SPEED** knob on DCU.

4.16.3 Arming Canisters.



Do not walk or stand in front of launcher racks when racks are loaded and arming levers are locked in armed position.

NOTE

Green latching levers must be in locked position before red arming levers are moved to armed position.

Verify red arming levers are fully forward to the arm (lock) position by pushing back levers without depressing plungers.

Mechanically arm one row of canisters at a time as follows:

1. Individually seat each canister of the five canisters in a row by pushing canisters in and up into rack keyholes. Canisters should be loaded top to bottom back to front.
2. Depress plunger on red arming lever with thumb and pull lever towards personnel. When

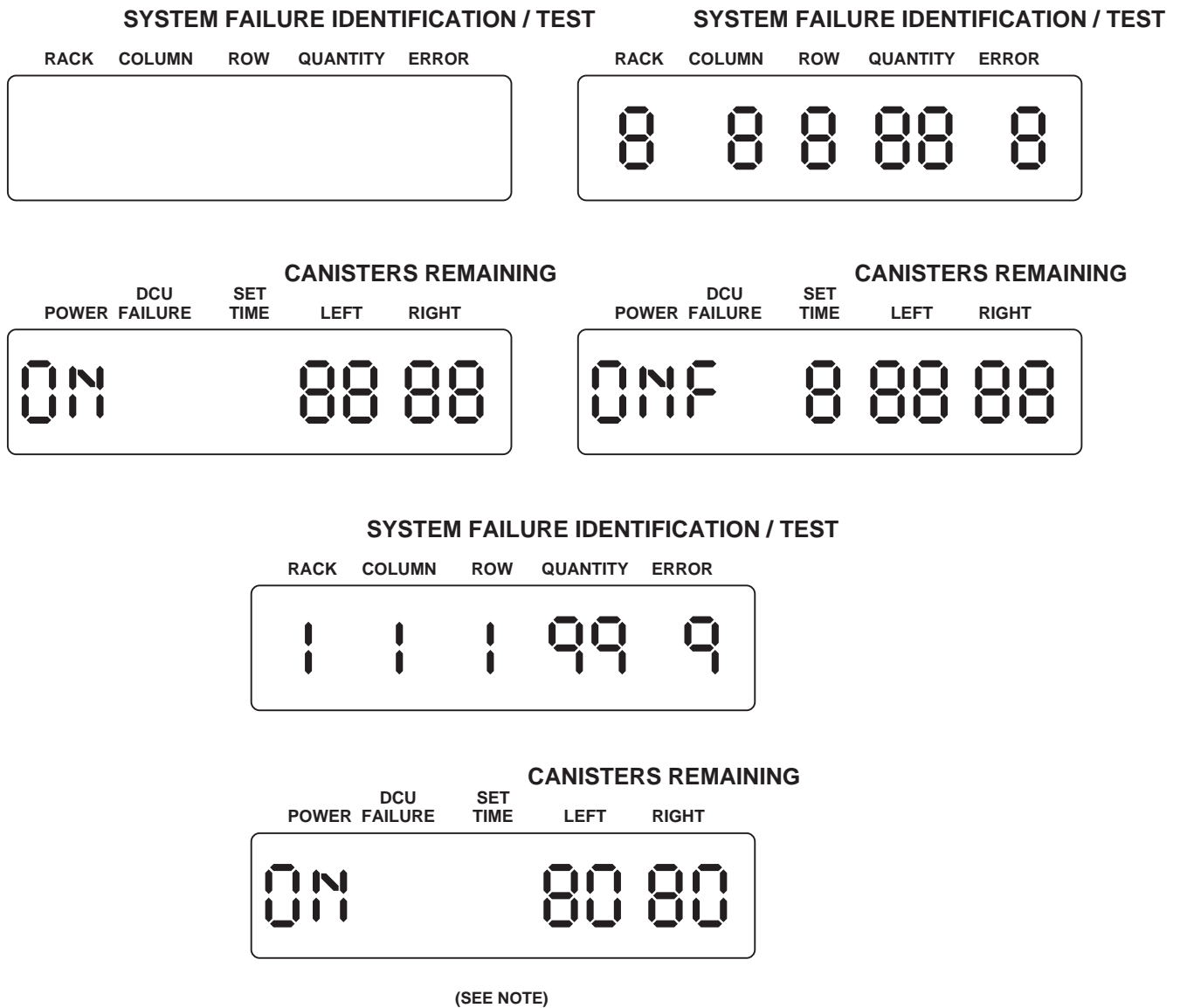

NOTE
READOUT IF NO CANISTERS ARE INSTALLED.

Figure 4-20. Volcano System DCU Displays **VOL**

lever begins to move, release thumb from plunger. When lever reaches locked position (about 45°) plunger will click out. Push inboard to ensure lever has locked (Figure 4-21).

3. Repeat steps 1 and 2 for all racks.
4. Remove all eight jettison system **REMOVE BEFORE FLIGHT** safety pins from each side panel.

NOTE

When operating the helicopter configured with the volcano system at high gross weight and high airspeeds, the pilot may encounter intermittent lateral tail pulse "tail shake". The intensity of the tail shake is further aggravated by left sideslip.

5. Lift off and proceed to designated target.
6. Prior to reaching target area remove safety pin and place the DCU **VOLCANO ARM** switch on the ICP in **ARMED** position (Figure 4-22). (Pull **VOLCANO ARM** switch out and lift up.)
7. **FIRE CIRCUIT** switch to **ENABLE**.

4.16.4 Mine Launch Control. Launching of mines is controlled by buttons on the pilot's cyclic control, marked **GA** (go around) (Figure 4-19). When the system is in an armed condition, pressing and releasing either **GA** button will start the launch sequence. If mines are being launched, press and release either **GA** button to stop mine launching. In addition to pressing the **GA** button to stop mine launch, the **VOLCANO ARM** switch may be moved to off (down) position or the **DCU FIRE CIRCUIT** switch may be placed **OFF**.

NOTE

If launching is stopped by pressing a **GA** switch before all mines are launched, the launch must be restarted within 60 seconds of stopping to prevent an error code. The **VOLCANO ARM** switch should also be moved to off (down) position within 60 seconds of stopping to prevent an error code.



Ensure same number of racks are installed on either side of aircraft.

Ensure same number of canisters are installed on either side of aircraft.

Partial load of canisters may result due to rack or canister failures (error codes 5, 8 or 9).

Partial canister loads, if not adjusted or balanced, will degrade mine field pattern.

1. Place **TEST/OVERRIDE** switch to **OVER-RIDE**.
2. After overriding error code 9, remove and discard all failed canisters.
3. One at a time, fill vacant positions left by removal of failed canisters as follows:
 - a. Remove canister from top rack of same side, forward most column, top most position with canister.
 - b. Place this canister in vacant position.
 - c. Repeat steps a. and b. above until all positions, other than those removed to fill vacant positions, have canisters.
4. Canister load may be balanced out by moving canisters from side with most canisters to side with fewest canisters as follows:
 - a. Remove canister from top rack, forward most column, topmost row of side with canisters.
 - b. Place removed canister in top rack, rear most column, lowest position of side with fewest canisters.

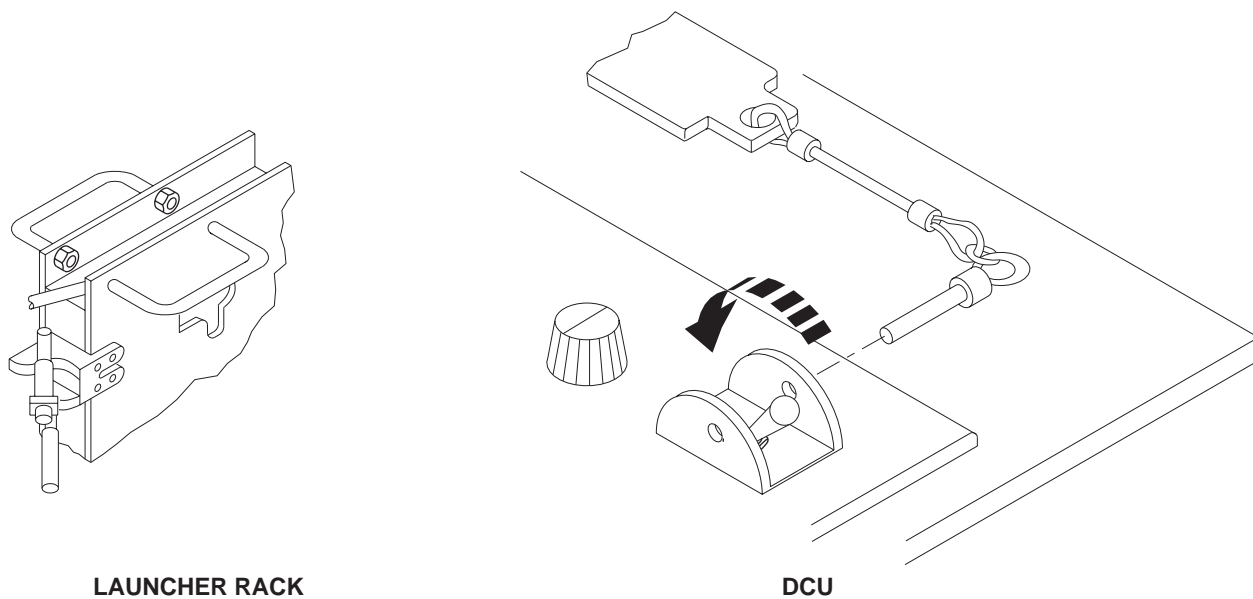

Figure 4-21. Arming Volcano System Canisters **VOL**

AA9413
SA

- c. Repeat steps a. and b. above until load is balanced.

- 4. Verify that the **HELICOPTER DELIVERY SPEED** settings agrees with the helicopter ground speed.

4.16.5 Mine Launch.

NOTE

Mine launching may be started and stopped as many times as required until all mines have been launched.

If launching is stopped by pressing a **GA** switch before all mines are launched, the launch must be restarted within 60 seconds after stopping to prevent an error code. The **VOLCANO ARM** switch may also be moved to off (down) position within 60 seconds after stopping to prevent an error code.

1. DCU **FIRE CIRCUIT** switch safety pin and streamer - Remove (Figure 4-21).
2. DCU **FIRE CIRCUIT** switch - **ENABLE**
3. Before reaching target, **VOLCANO ARM**-switch - **VOLCANO ARMED** position (pull **ARM** switch out and up) (Figure 4-22).



FIRE CIRCUIT switch must be enabled for at least two minutes prior to mine launching.

- 5. **GA** button - Press either pilot's to start launching mines. Press either **GA** switch a second time to stop mine launching.

NOTE

If launching is interrupted for longer than 60 seconds, the **ARMED** light on the ICP will flash and error code 1 will be displayed in the DCU **ERROR** indicator.

- 6. If launch is interrupted longer than 60 seconds, resume launch by placing **VOLCANO ARM** switch to the off position for at least sixteen seconds, place **VOLCANO ARM** switch back

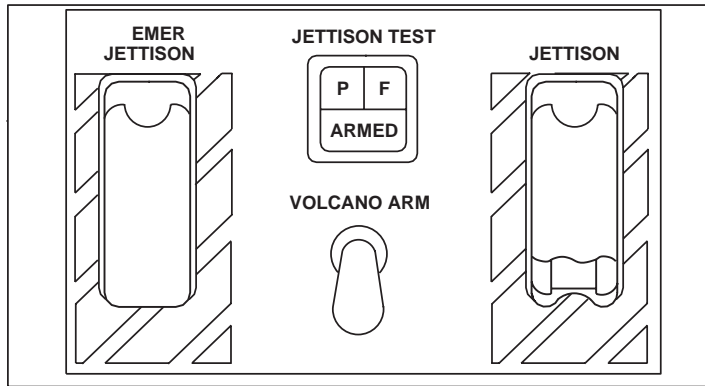

AA9414
SA

Figure 4-22. Volcano ICP **VOL**

to **ARM** position. Verify a steady **ARMED** is displayed on the ICP. Launching can then be resumed.

7. During mine launching, if an error code appears on DCU panel that effects mission performance, do the following:
 - a. Place **FIRE CIRCUIT** switch on DCU to **OFF** .
 - b. Install safety pin and streamer assembly to **FIRE CIRCUIT** switch.
 - c. Toggle DCU **POWER** switch to **OFF**.
 - d. Return to down loading area and remove canisters, refer to TM 9-1095-208-23-2&P.

4.16.6 Volcano System Recycle Procedures. These procedures are to be used in the event of a volcano system lock-up during a tactical mission.

NOTE

If any error codes occur during this recycle, return to step 1 and repeat all steps.

1. Identify error code.
2. Return the **VOLCANO ARM** switch on the ICP to the safe position.
3. Return the **FIRE CIRCUIT ENABLE** switch on the DCU to the **OFF** position.
4. Toggle the **POWER** switch on the DCU to **OFF**, then release. Ensure DCU turns off.
5. Leave the DCU turned off at least two minutes prior to system restart.

NOTE

During cold temperature operation (less than 0°C (32°F)) , the DCU should be turned off at least five minutes prior to system restart.

6. After waiting the minimum time, toggle **POWER** switch to on, then release. Ensure that the DCU displays the following sequence:
 - a. Error code **F**.
 - b. **"ON"** displayed under **POWER**.

- c. All "8's" in the remainder of the displays.
 - d. The DCU is blank, except for the "ON" message.
7. Wait approximately one minute. At that time, the DCU should display "88 88" under **CANISTERS REMAINING**.
 8. Toggle the **TEST/OVERRIDE** switch to **TEST**, then release.
 9. After approximately two minutes, the DCU should display "80 80" or what was displayed upon canister installation under **CANISTER REMAINING**.
 10. After approximately 15 seconds, the number under **SET TIME** should flash. At that time, turn **SELF DESTRUCT TIME** knob to **RE-SET** for 20 seconds.
 11. Turn **SELF DESTRUCT** knob to the desired setting. Ensure that this setting is displayed under **SET TIME** without any flashing.
 12. Move the **FIRE CIRCUIT ENABLE** switch on DCU to **ENABLE**.

13. Move the **VOLCANO ARM** switch on the ICP to **ARM**, if the switch was in that position before restarting.

4.16.7 Partial Load Error Codes.

a. Three error codes can be overridden to allow mine laying without a full load of canisters. These are:

(1) Error code 5 - Rack problems. This allows operation with less than 4 racks, if desired, for laying an abbreviated minefield.

(2) Error code 8 - Rack electronics error. This error indicates one complete row of ten canisters is not available. No other errors shall be overridden with the error code 8 override.

(3) Error code 9 - Canister failure. Canister failures are allowed to be overridden. Failed canister should be removed and remaining canisters balanced prior to mission.

b. Troubleshoot all error codes overridden during mission after completion of flight and make an

appropriate entry on DA Form 2408-13-1, refer to TM 9-1095-208-23-2&P.

erator will be required to perform additional checks when operating during extreme climatic conditions.

4.16.8 Volcano Post Mission Procedures.

4.16.8.1 Post Mine Launch Check.

1. Switch **VOLCANO ARM** switch on ICP off (down) position.
2. Switch **FIRE CIRCUIT** switch on DCU to **OFF**.
3. Install safety pin and streamer assembly to **FIRE CIRCUIT** switch.
4. Toggle DCU **POWER** switch to **OFF**.

4.16.8.2 After Landing Checks.



Do not stand in front of rack loaded with mine canisters. All personnel will remain clear of the outboard side of the launcher racks until the arming levers are safe and the jettison safety pins are installed, or until the helicopter is shutdown and power removed.

1. Install jettison safety pins (four on each rack).
2. Push in plunger on red arming lever and push lever back until it is in safe position, parallel with rack and plunger clicks out. Latch all arming levers in safe position.

4.16.8.3 Post Flight Checks.

1. Remove canisters.
2. Record all error codes overridden during mission on DA Form 2408-13-1.
3. Install launcher rack covers.

4.16.9 Volcano Operation Under Unusual Conditions. The volcano system is designed to operate during adverse weather and extreme temperature conditions. Op-

4.16.9.1 Operating In Extreme Cold.



Do not force launcher rack levers or mounting pins to operate.

Static electricity discharges may damage DCU.

NOTE

Operators wearing arctic gloves should have no difficulty installing or operating the volcano system.

1. Check movement of launcher rack arming and latching levers to ensure that they do not bind. Use warm air source to loosen if required.
2. Install launcher rack cover when dispenser is installed, but canisters have not been loaded.
3. Perform complete volcano operational check before any mission (paragraph 4.16.2).
4. Assure all expando and/or single acting pins have seated and spring button is out.
5. Check to see that launcher rack levers and canister connectors are free of ice, snow and frost. Use warm air source to clean and dry as necessary.
6. Allow 10 minutes of additional warm up time before using system.
7. Prior to turning on power, make sure all DCU switches are free of ice, that **FIRE CIRCUIT** switch and streamer are free of ice, and that rotary switches move freely. Use warm air to heat and dry sticking or stiff switches.

4.16.9.2 Operating In Wet, Mud, Salt Water and Ice Conditions.

WARNING

Wet and/or icy hardware may be slippery. Use extra precaution when handling dispenser components. Do not force ice covered launcher rack levers.

1. During flight in icing conditions shed ice particles may cause foreign object damage (FOD) to the helicopter, especially main rotor and tail rotor blades and engine compressors. Flight tests have shown that this FOD is difficult to detect during flight. Minimizing descent rates after ice has accumulated on the helicopter or external stores should reduce the probability of FOD because the airflow will carry particles aft and down away from the helicopter. Normal instrument procedure descents or approximately 100 feet per minute (fpm) or less are preferable. During shutdown, crewmember's should be alert for unusual engine noise (high pitched whine) that indicates compressor damage. The helicopter should be visually inspected prior to further flight.
2. Engine torque increase of up to 20 percent can be expected during cruise flights in icing conditions with the volcano system installed.
3. After flight in icing conditions with the volcano system installed, the jettison safety pins may be difficult to install due to ice in and around the safety pin holes. The forward launcher rack locking levers and arming levers may also be covered with ice making it difficult to move the arming levers to the safe position. Use an external heater to remove ice from these areas. Do not use foreign objects to break ice from these areas as this may cause damage to the system.
4. Do not bend ice covered cables until ice has been removed with a warm air source.
5. Check launcher rack canister connectors for ice. Use warm air source to melt and dry connectors.
6. Check launcher rack arming and latching levers for ice. Use warm air source to remove ice. Test operation of levers to assure they have free movement.
7. Check expando and single acting pins to ensure that they are seated and spring button is out.
8. After exposure to mud or salt water, clean and wash dispenser components immediately. If dirty, clean, wash and dry components before repackaging them into shipping containers, refer to TM 9-1095-208-23-2&P.
9. When DCU cover is removed, make sure that switches are free of ice. Remove ice using warm air source.
10. Check DCU connectors for ice. Remove ice using warm air source.
11. Check DCU switch for ice. Remove ice with warm air source.
12. Allow 10 minutes of additional warm up time before testing and operating dispenser.
13. Perform PMCS, refer to TM 9-1095-208-23-2&P.
14. Perform complete volcano operational check before any mission (paragraph 4.16.2).

4.16.10 Accident Procedures.

WARNING

After an accident, turn DCU power OFF, evacuate all personnel to a distance of 2000 feet (640 meters) and notify EOD.

Section III CARGO HANDLING SYSTEMS

4.17 CARGO HOOK SYSTEM.

The system consists of a hook assembly (Figure 4-23) mounted on the lower fuselage, a control panel on the upper console (Figure 2-7), a normal release button on each cyclic stick grip, one emergency release switch on each collective stick grip, and a firing key in the cabin for use by the crew chief. The system incorporates three modes of load release, an electrical circuit actuated from the cockpit, a manual release worked by the crewmember through a covered hatch in the cabin floor, and an emergency release system using an electrically-activated explosive charge.

4.17.1 Cargo Hook Stowage. The cargo hook shall be maintained in the stowed position during periods of non-use. The cargo hook can be placed in a stowed position (Figure 4-23) by opening the cargo hook access cover in the cabin floor, and pulling the hook to the right and up. When the hook is in the stowed position, the load beam rests on a spring-loaded latch assembly and is prevented from vibrating by a teflon bumper applying downward pressure on the load beam. To release the hook from its stowed position, downward pressure is placed on the latch assembly lever, retracting the latch from beneath the load beam, allowing the cargo hook to swing into operating position.

4.17.2 Cargo Hook Control Panel. The **CARGO HOOK** control panel (Figure 4-23), on the upper console, consists of an **EMERG REL NORM, OPEN, SHORT** test switch, a **TEST** light, **CONTR CKPT** or **ALL** station selector switch and an **ARMING, SAFE, ARMED** switch. Before the normal release (electrical) can operate, the **ARMING** switch must be at **ARMED** to provide electrical power to the release switches. The pilot and copilot **CARGO REL** switches, on the cyclics, will release the load when the **CONTR** switch is at **CKPT** or **ALL**. The crewmember's **NORMAL RLSE** switch will release the load when the **CONTR** switch is at **ALL**. The **EMERG REL** switch and **TEST** light permits checking the emergency release circuit when at **SHORT** or **OPEN**. In both cases of testing, if the release circuit is good, the **TEST** light will go on when the **HOOK EMER REL** switch on pilot's or copilot's collective, or the **EMER RLSE** switch on the crewmember's pendant, is pressed.

4.17.3 Crewmember's Cargo Hook Control Pendant. The crewmember's cargo hook control pendant (Figure 4-24), in the aft cabin, provides the crew chief with

an electrical release and jettison of an external load when the **CARGO HOOK CONTR** switch is placed to **ALL**. The **NORMAL RLSE** and **EMER RLSE** switches are covered by guards to prevent accidental activation. When the cover is raised the switch can be pressed. When not in use, the pendant is stowed in the stowage bag at the back of the pilot's seat. Electrical power to operate the pendant is provided from the No. 2 dc primary bus through a circuit breaker, marked **CARGO HOOK CONTR**.

4.17.3.1 Normal Release. Normal release of external cargo is done by pressing the **CARGO REL** switch on either cyclic stick grip or the **CARGO HOOK NORMAL RLSE** on the crewmember's cargo hook pendant, after placing the **CARGO HOOK ARMING** switch to **ARMED**. A light on the advisory panel will go on, indicating **HOOK ARMED**. This informs the pilot that electrical power is applied to the control circuit; the actuation of any of the release switches will release the load. When the **CARGO REL** switch is pressed and the release solenoid begins to move, a switch closes, lighting the **CARGO HOOK OPEN** advisory light. The load arm will swing open, releasing the cargo. When the sling is detached from the load beam, spring tension on the arm will cause it to close and relatch, putting out the **CARGO HOOK OPEN** advisory light. The normal release system is a one-shot cycle; once the solenoid travel begins and the load arm relatches, the release cycle can again be initiated. Power to operate the normal release system is supplied from the No. 2 dc primary bus through circuit breakers marked **CARGO HOOK CONTR** and **PWR**.

4.17.3.2 Operational Check - Normal Release Mode.

1. **CARGO HOOK CONTR** switch - As required. **CKPT** for pilot and copilot check, or **ALL** for crewmember check.
2. **CARGO HOOK ARMING** switch - **ARMED**.
3. **HOOK ARMED** advisory light - Check on.
4. Place about 20 pounds downward pressure on load beam.

5. **CARGO REL** switch (pilot and copilot);
NORMAL RLSE (crewmember) - Press and
release.

6. **CARGO HOOK OPEN** advisory light - Check
on. |

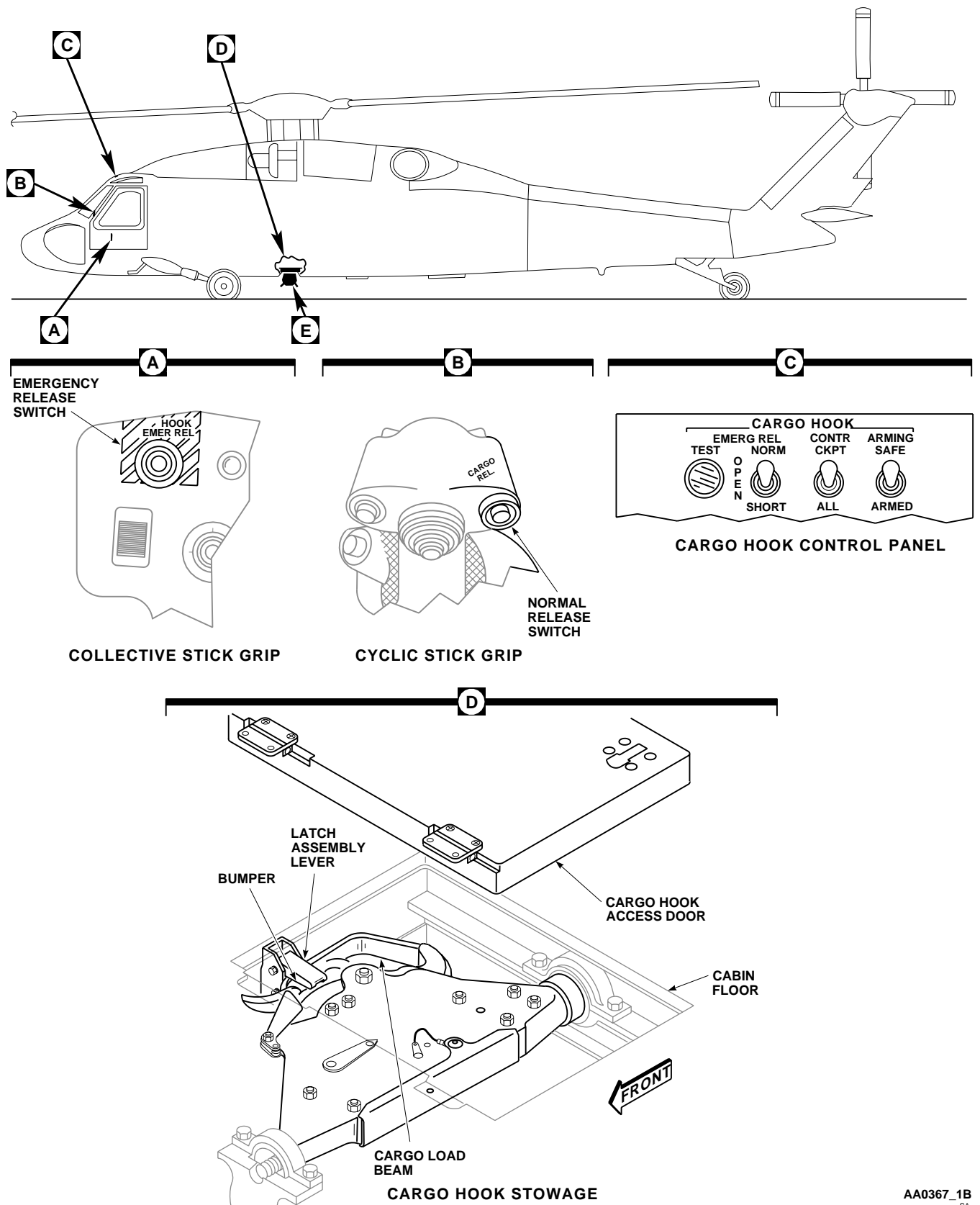

AA0367_1B
SA

Figure 4-23. Cargo Hook System (Sheet 1 of 2)

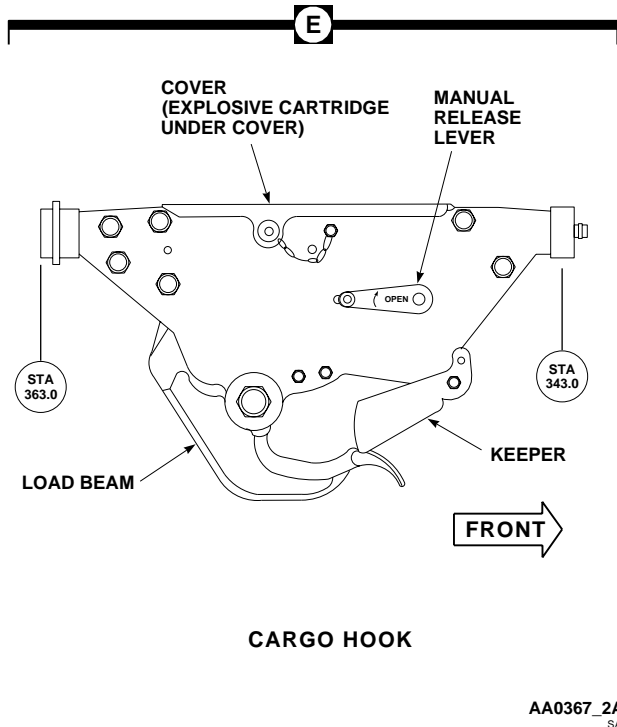

Figure 4-23. Cargo Hook System (Sheet 2 of 2)

7. **CARGO HOOK OPEN** advisory light - Check off when hook closes.
8. Repeat steps 4. through 7. for copilot and crewmember position.

4.17.3.3 Manual Release. Manual release of external cargo can be done from the cabin, through a covered port in the floor, or by ground personnel from outside the helicopter, with power on or off. Turning the release control on the right side of the hook (Figure 4-23) clockwise, causes the latching mechanism to release the load beam. The load beam will not move unless a downward pressure is exerted to cause opening. With power applied to the helicopter and the **CARGO HOOK ARMING** switch at **ARMED**, the **CARGO HOOK OPEN** advisory light will go on at the start of release control turning, and will go off at the end of release control rotation.

4.17.3.4 Operational Check - Manual Release Mode.

1. Manual release lever spring - Installed. Check that spring is straight and provides positive pressure on the lever.

2. Place about 20 pounds downward pressure on load beam.
3. Manual release lever - Pull up/turn fully clockwise and release.
4. Load beam - Check open.
5. **CARGO HOOK OPEN** advisory light - On.
6. When downward pressure is released, load beam will close and latch.
7. **CARGO HOOK OPEN** advisory light - Off when hook closes.

4.17.4 Emergency Release Circuit Tester. The cargo hook emergency release circuit tester (Figure 2-7) marked **CARGO HOOK EMERG REL** on the upper console, contains a test light and switch. The test light, marked **TEST**, goes on during circuit testing to indicate the system is functioning properly. The switch, with marked positions **NORM**, **OPEN**, and **SHORT**, is normally at **NORM**. When the switch is placed to **OPEN** or **SHORT** and the cargo **HOOK EMERG REL** switch on the pilot's or copilot's collective, or **EMERG RLSE** switch on the crewmember's cargo hook control pendant is pressed, the circuit tester light will go on if the circuit is good.

4.17.4.1 Cargo Hook Emergency Release Circuit Check.

1. **EMERG REL TEST** light - Press. Light should be on.

NOTE

To prevent unintentional discharge of the cargo hook explosive cartridge, the pilot shall call off each procedural step of the emergency release circuit test before that step is done. Station being checked shall reply to pilot's command.

2. Pilot's release - Check.
 - a. Short test.
 - (1) **CARGO HOOK EMERG REL** switch - **SHORT**.
 - (2) Pilot's **HOOK EMERG REL** button - Press and hold.
 - (3) **CARGO HOOK TEST** light - On.

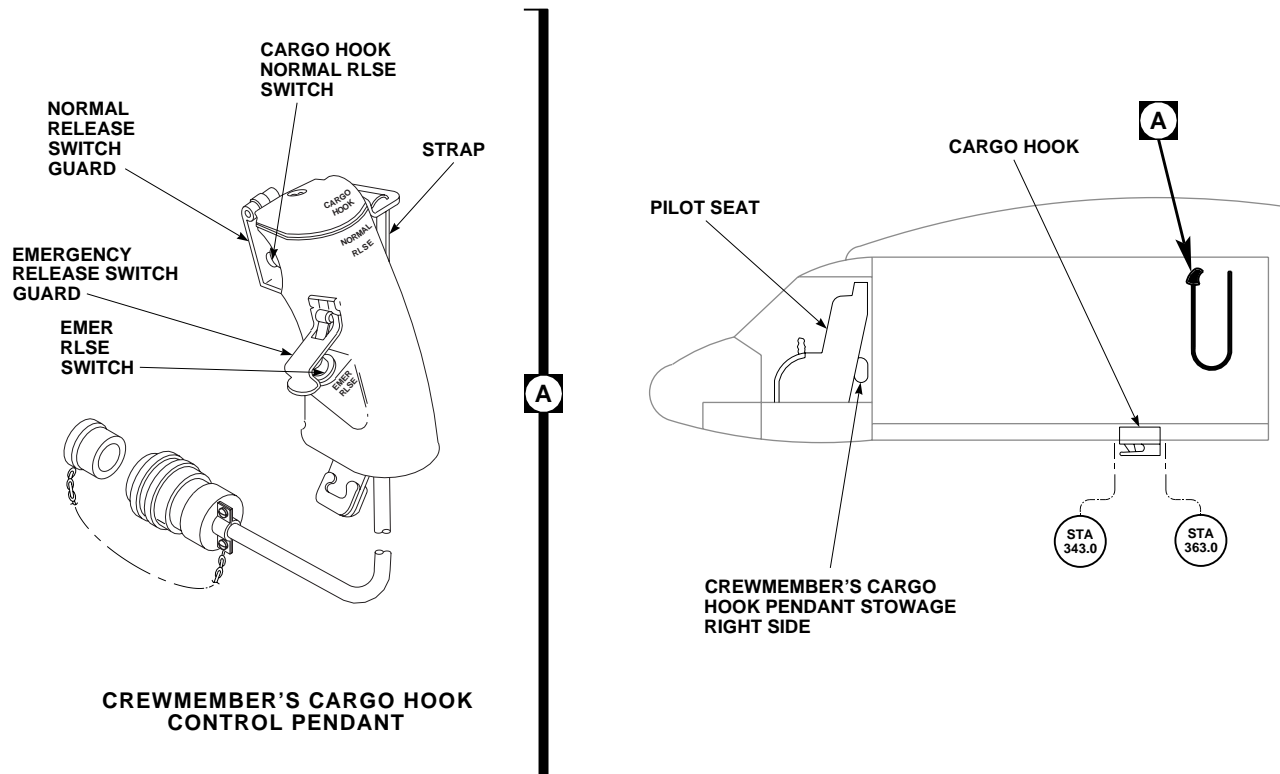

AA0368
SA

Figure 4-24. Crewmember's Cargo Hook Control Pendant **UH**

- (4) **HOOK EMER REL** button - Release. **TEST** light off.
 - (5) Repeat steps (2) through (4) for copilot's **HOOK EMER REL** button, and crewmember's cargo hook control pendant **EMER RLSE** button.
- b. Open test.
- (1) **CARGO HOOK EMERG REL** switch - **OPEN**.
 - (2) Pilot's **HOOK EMER REL** button - Press and hold.
 - (3) **CARGO HOOK TEST** light - On.
 - (4) **HOOK EMER REL** button - Release. **TEST** light off.
 - (5) Repeat steps (2) through (4) for copilot's **HOOK EMER REL** button, and crewmember's cargo hook control pendant **EMER RLSE** button.
3. **CARGO HOOK EMERG REL** switch - **NORM**. If the cargo hook is not to be used

immediately after completing the circuit test check, the **EMERG REL** switch shall remain at **OPEN** until ready for load pickup.

4.17.4.2 Emergency Release.

NOTE

When the emergency hook release has been used and a replacement squib (explosive cartridge) is not available, the hook can not be used until the explosive device is replaced, since the hook load beam will not close and lock.

Emergency release of an external cargo load is done by an electrically-fired explosive cartridge, initiated from either of the collective stick grip switches, marked **HOOK EMER REL**, or the crewman's cargo hook control pendant, marked **EMER RLSE**. The emergency release is used when the electrical and manual releases are inoperative, and the load must be jettisoned. With the **CARGO HOOK EMERG REL** switch at **NORM**, power will be applied to the emergency release switch. Pressing the switch applies 28 vdc to the explosive cartridge, producing a high gas pressure to drive a piston in the lock assembly, releasing the load arm lock. The weight of the load will cause the

load arm to open. Once the emergency release is used, the hook will remain open and the **CARGO HOOK OPEN** advisory light will remain on until the explosive cartridge device is replaced. When the explosive cartridge device is replaced the load arm will close, the light will go off, and the emergency release mode is returned to operation. Power to operate the emergency release system is from the dc essential bus through a circuit breaker, marked **CARGO HOOK EMER**.

4.17.5 Preflight. When cargo hook loads are to be carried, checks within this paragraph and procedures of paragraphs 4.17.6, 4.17.7, 4.17.8 and 4.17.9 apply.

1. Cargo hook - Check condition, security and explosive cartridge installed.
2. Emergency release system - Check. (Go to paragraph 4.17.4.)
3. Manual release - Check. (Go to paragraph 4.17.3.3.)

4.17.6 Before Takeoff.

1. **CARGO HOOK EMERG REL** switch - **NORM**.

2. **CARGO HOOK ARMING** switch - **ARMED**.

4.17.7 Emergency Release Procedure.

Pilot or copilot **HOOK EMER REL** or crewman's control pendant **EMER RLSE** - Press.

4.17.8 In-flight Procedures.



Cargo suspended from the cargo hook should not be over a 30° cone angle. To prevent damage to the cargo hook keeper, the pilot shall use extreme care to prevent placing load pressure on the keeper.

CARGO HOOK ARMING switch - As required. **ARMED** for low altitude/low airspeed. **SAFE** at cruise altitude and airspeed.

4.17.9 Before Landing.

- CARGO HOOK ARMING** switch - **ARMED**.

Section IV MISSION FLEXIBLE SYSTEMS

4.18 MISSION READINESS CIRCUIT BREAKER PANEL.

The mission readiness circuit breaker panel (Figure 2-20) is on the No. 1 electrical junction box in the cabin, and contains all required circuit breakers for mission equipment.

4.19 RESCUE HOIST SYSTEM KIT.

The high performance, two speed rescue hoist (Figure 4-25) is post-mounted in the cabin on the right side of the helicopter when installed. The hoist system consists of modular components, electrically-driven and electronically-controlled, to provide maximum lift capacities of 300 pounds at 0 to 250 feet-per-minute and 600 pounds at 0 to 125 feet-per-minute. The heaviest weight that may be suspended from the hoist is 600 pounds. A speed mode switch at the back of rescue hoist control panel assembly on the hoist support assembly, provides a selection of either **SLOW** speed (0 to 125 feet-per-minute), or **FAST** speed (0 to 250 feet-per-minute). The hoist motor mounted at the top of the pole provides selectable 125 or 250 feet-per-minute reel-in and reel-out drive of a 250-foot hoist cable. A fail safe mechanism limits the induced loading to the hoist to 1200 pounds at all times. A continuously running circulating fan cools the hoist motor. The hoist is controlled through a lower console mounted **RESCUE HOIST CONTROL** panel and/or crewman's control pendant grip in the cabin. A hoist cable cutter system is used to cut the hoist cable in case of emergency, by exploding a squib-actuated cable-cutter. The cut cable then drops free of the hoist boom. Power to operate the rescue hoist system is from the No. 2 dc primary bus through a circuit breaker on the mission readiness circuit breaker panel, marked **RESQ HST CONTROL**. Power for the cable cutter system is from the dc essential bus through a circuit breaker, marked **HOIST CABLE SHEAR**. Refer to Table 2-4 for servicing.

4.19.1 Controls and Function. The **RESCUE HOIST CONTROL** panel (Figure 4-25) has all necessary controls for operating the hoist from the cockpit, and contains the system **MASTER** switch, controlling **ON** or **OFF** for both cockpit and cabin. The hoist will respond to the first control signal received.

NOTE

During hoist operation, over travel of the cable assembly may occur in the extended mode of operation after stopping hoist op-

eration in mid-travel. Cable over travel should not exceed ten feet.

CONTROL/ INDICATOR	FUNCTION
BOOM switch	Swings hoist boom in or out from cockpit.
OFF	Static position, removes electrical power from hoist boom positioning motor.
IN	Provides power to boom motor to position boom inboard from cockpit.
OUT	Provides power to boom motor to position boom outboard from cockpit.
MASTER switch	Selects control point for hoist operation.
OFF	Disconnects all electrical power from hoist operating controls.
ON	Provides power to both cockpit controls and crewman's pendant for hoist operation.
CABLE	Provide cable up or down control from cockpit.
OFF	Static position, removes electrical power from hoist reel motor for cockpit operation.
UP	Provides power to hoist reel motor to reel in cable operation from cockpit at 250 feet-per-minute only.
DOWN	Provides power to hoist reel motor to reel out cable operation from cockpit at 250 feet-per-minute only.
SQUIB switch	Selects either TEST or NORM operation.
TEST	Checks condition of CABLE SHEAR circuit through squib to indicate circuit is complete.

CONTROL/ INDICATOR	FUNCTION
NORM	Places squib circuit in a ready for fire condition.
IND	Lights when test of CABLE SHEAR circuit through squib is good.
CABLE SHEAR switch	Controls cable cutter firing circuit.
FIRE	Directs electrical power to cable cutter squib for shearing hoist cable.
SAFE	Removes electrical power from cable cutter circuit.

4.19.2 Boom Assembly Module. The boom assembly module consists of the boom structure boom head, up limit switch, cable-cut device, and a cable guide, all installed in the boom. The boom head is allowed to swivel 65° above the boom cable and 30° from side-to-side and guide the cable to wrap or unwrap from a 30° cone angle. The upper limits of cable control includes an automatic means for decelerating the cable to 67 feet-per-minute cable speed. At 8 to 10 feet below the boom head, a caution light on the crewman’s control pendant marked **CAUTION** will go on. The cable will again decrease speed to 12 feet-per-minute at 12 to 18 inches below the boom head.

4.19.3 Limit Switches. Four limit switches are actuated by actuation assembly cams. They are: a down all stop, that actuates when 250 feet of cable is reeled out; a down limit switch, that actuates at 247 feet, to provide deceleration; a 10-foot caution switch that actuates when the hook is within 10 feet of the boom head or within 10 feet of the down limit (240 feet); and an up deceleration switch, that actuates when the cable hook is within 12 inches of the boom head.

4.19.4 Crewman’s Control Pendant Grip. The crewman’s control pendant grip (Figure 4-25) is a hand-held

control in the cabin. The pendant grip is connected to the control box by a cable connector. The control pendant contains three switches and two caution/warning lights: **HOIST** cable control, **BOOM** positioning, and **ICS** switches; **OVERTEMP** and cable 10-foot **CAUTION** lights. The **HOIST** control is a directional and variable speed spring loaded to center switch, with marked positions of **OFF**, **UP** and **DOWN**. As the switch is moved further away from **OFF**, the hoist speed increases in the marked direction. When the switch is released the hoist will stop. The **BOOM** position switch, with marked positions **OUT** and **IN**, operates in the same manner as the **HOIST** switch, except the boom moves in or out at a single speed. Two lights are installed on the crewman’s control pendant. They are: The 10-foot **CAUTION** light to warn the crewman whenever the hoist cable is 10 feet or less from the all stop limits. A red **OVERTEMP** light that warns the crewman of an overtemperature condition in either the hoist lubrication systems or the hoist motor. Whenever the **OVERTEMP** light is on, the hoist should be allowed to cool down until the light goes off. The ICS control switch, on the front of the pendant, provides the operator with inter-helicopter communication.

4.19.5 Cable Shear System. A cable shear feature releases a rescue hoist load in case of an emergency. The system consists of a squib-actuated cable cutter, a **CABLE SHEAR** switch on the pilot’s control panel and a shear switch at the hoist assembly and a **SQUIB** test circuit. The cutter may be fired by the pilot or the copilot from the **SHEAR** switch on the control panel (Figure 4-25) or by the hoist operator using the **CABLE-CUT** switch on top of the control box. The **SQUIB** test circuit consists of a **TEST-NORM** switch and a test good **IND** light. When the **SQUIB** switch is at **NORM** and the **SHEAR** switch is placed to **FIRE**, electrical power is sent to the dual squib for firing. The exploding cartridge then drives a cutter into the hoist cable and shears it. The rescue hoist cable shear feature is operational whenever power is applied to the helicopter. Once fired, a replacement cable cutter kit and cable must be replaced. Power to operate the cable shear is provided from the dc essential bus, through a circuit breaker marked **HOIST CABLE SHEAR**.

4.19.6 Operation.

WARNING

It is the hoist operator's responsibility to assure that the hoist cable does not contact any portion of the aircraft. The rescue hoist cable must be kept clear of all parts of the aircraft and free from other external obstacles when operating the hoist. Cable abrasion during hoist operations can lead to cable failure. If cable contact or snagging occurs, interrupt hoist operations and inspect the cable for damage in accordance with applicable procedures. If any broken wires, unraveling, or kinks are observed, hoisting operations should be discontinued and the cable replaced.

Reeling a kinked/damaged cable into the hoist may cause a hoist jam condition when reel-out is attempted, rendering hoist inoperative.

The hoist operator is responsible to maintain stability of the hoisted load by use of hoist controls, ICS calls to pilot, and physical control of cable (hand or foot). For minor

oscillation (linear or circular swing), stop reel-in, apply hand motion to cable in direction opposite to oscillation. For significant oscillation, stop reel-in, start reel-out or call for pilot to lower aircraft.

WARNING

If the oscillation is not quickly stopped, it may become unmanageable. Reeling in an oscillating load will only aggravate the motion.

All crew should watch for shock loads, jerks, or snaps that impart high loads on cable. If observed, hoisting should be interrupted and cable inspection undertaken to verify integrity (no broken wires, unraveling, or kinks) before resuming operations. Refer to TM 55-1680-320-23&P, high performance rescue hoist assembly.

4.19.6.1 Preflight (If use is anticipated).

1. Check oil level:
 - a. Release reaction arm and pivot hoist to operating position.

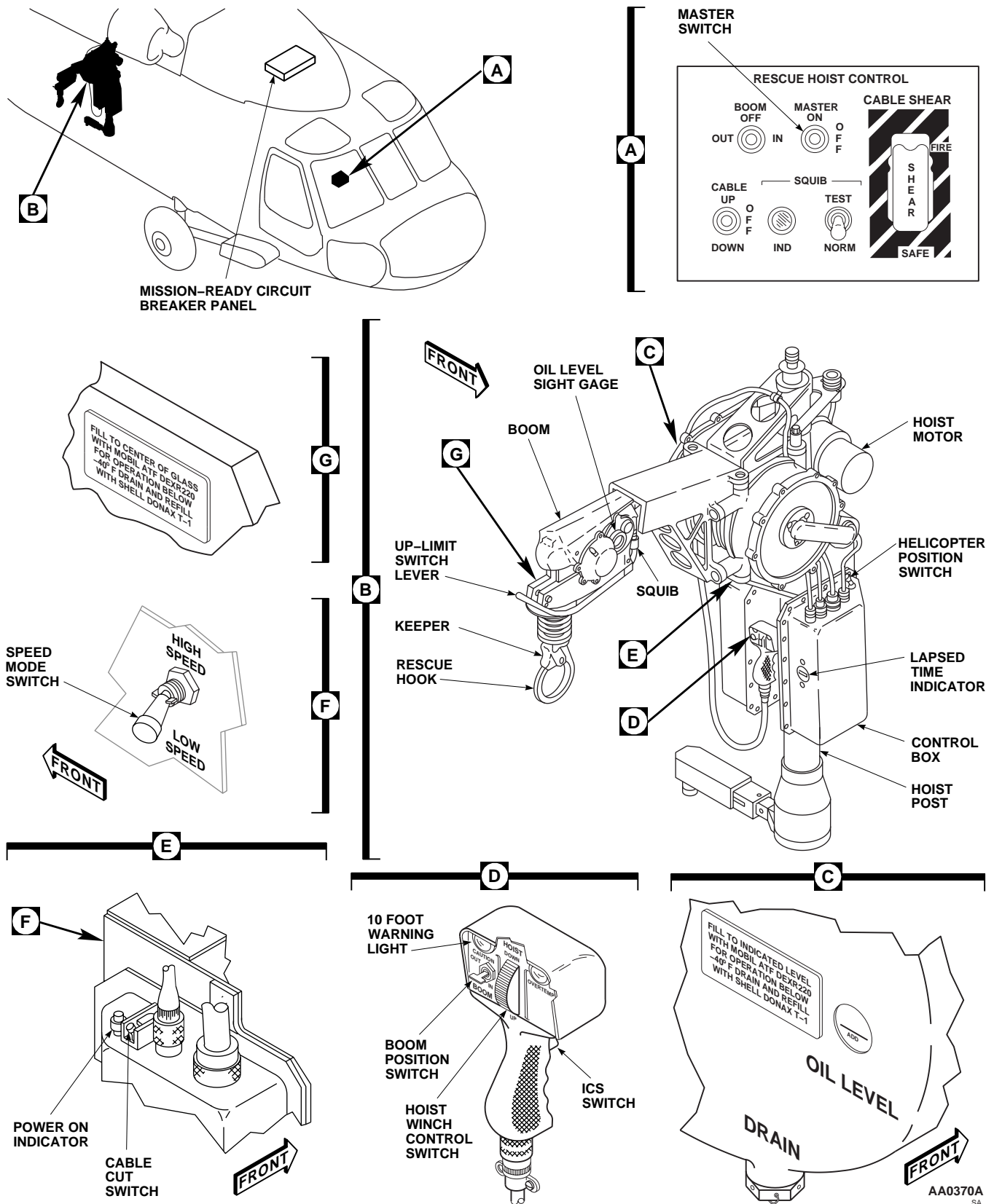

Figure 4-25. Rescue Hoist Kit **UH**

- b. Check oil level in hoist and boom head.
 - c. Return hoist to stowed position and secure reaction arm.
2. Check upper attachment (make sure hose clamp is installed).
 3. Check lower attachment (mounting plates, pip pins, and star plate).
 4. Check position switch (positions 2 and 4).
 5. Ensure hoist main power cable cannon plug is safetied at junction box.
 6. Cable cut switches - Down and safetied.
 7. Make sure metallic shorting strip is removed from cable cut cannon plug.
 8. Cable cutter connector attached.
 9. Check recovery devices are functional and complete. Make sure recovery devices are secure.
 10. Make sure crewmembers have proper personal equipment (safety harness, leather gloves, and proper visors).
 11. Hoist control circuit breaker - In (mission essential circuit breaker panel).

4.19.6.2 Rescue Hoist Squib Circuit Test.

1. **SQUIB** switch - Hold at **TEST**.
2. **SQUIB IND** light - Check on.
3. **SQUIB** switch - Release to **NORM**. **SQUIB IND** light off.

4.19.6.3 Boom Position and Hoist Cable Control Operational Check.

To position the rescue hoist inboard or outboard, do this:

1. **MASTER** switch - **ON**.
2. Hoist operator - Check power on indicator (blue light), check yellow caution light on control pendant is on, and cooling fan operating.
3. Check ICS switch on pendant.

WARNING

Hands must be kept off hoist boom during operation to prevent hand entrapment and injury.

4. Hoist operator - **BOOM** switch - **OUT** and then **IN**.
5. **RESCUE HOIST CONTROL** panel - Rotate boom **OUT**; then **IN**, then **OUT** to test boom operation.
6. Speed mode switch - **HIGH**.

WARNING

Rescue hoist cable is stiff and abrasive. Broken cable strands are sharp, therefore leather work gloves must be worn whenever handling rescue hoist cables.

A crewmember must reel cable out from the boom head in line with the boom axis during the following test procedures. Care must be taken not to pull the cable taut around the cable guide/roller, since kinking of the cable might result. Avoid damaging cable on rough surfaces, including the ground.

7. **RESCUE HOIST CONTROL** panel - **DOWN**, reel cable out until caution light is off.
8. **RESCUE HOIST CONTROL** panel - Reel in cable and observe that cable speed slows when caution light goes on (8 to 10 feet of cable out).
9. Boom up limit actuator arm - Push up on arm during reeling in to check that hoist stops running when up limit switches are activated. Observe that cable slows when hook is 12 to 18 inches from full up position.
10. Repeat steps 7. through 9, using control pendant assembly. Check that cable speed can be regulated by control pendant from 0 to 250 fpm when cable is reeled out beyond 10 feet.

11. Speed mode switch - **LOW**. Repeat steps 7. through 9, using control pendant assembly. Check that cable speed can be regulated by control pendant from 0 to 125 fpm when cable is reeled out beyond 10 feet.



Make sure hoist cable is completely up, to prevent cable wear between cable and hook assembly.

12. **BOOM** switch - Rotate boom in to stowed position.

4.19.7 Stopping Procedure.

MASTER switch - As desired.

4.20 AUXILIARY ELECTRICAL CABIN HEATER. (ON HELICOPTERS EQUIPPED WITH AUXILIARY CABIN HEATER KIT.)

A 55,000 BTU/hr electrical auxiliary cabin heater is installed in the transition section to provide an increase in cabin temperature in extremely cold environments. The auxiliary heater system consists of a heater control panel on the lower console replacing the retransmission control panel when the heater kit is installed (Figure 4-26), a blower and

electrical heater unit in the transition section, a heater inlet port on the cabin aft bulkhead (Figure 2-5), a temperature control located under the left gunner's window, and ducting throughout the cabin. The auxiliary heater system is turned on from the cockpit by a switch, marked **OFF-ON-RESET** on the **AUX CABIN HEATER** control panel. With both main generators operating and **AUX CABIN HEATER** switch **ON**, the **HTR ON** light on the control panel will go on indicating that power is applied through the heater control relay to the duct temperature sensor and to the blower motor and cabin heater elements. If a heater unit overheats, an element thermostat circuit will automatically open, causing the heater to shut off. When the element cools, the **AUX CABIN HEATER** switch must be momentarily placed at **RESET** to restore the system. A heater outlet duct cycling thermostat is also provided at the air outlet side of the heater. If duct temperature exceeds $82^{\circ} \pm 8^{\circ}\text{C}$, the temperature sensor contacts will open, temporarily interrupting power to the heater elements. On decreasing temperature, the contacts will automatically reset to closed at $77^{\circ} \pm 8^{\circ}\text{C}$ to restore power. A redundant duct overheat sensor/shutoff switch is installed next to the duct cycling thermostat to shut off power to the heater elements if the delivered air flow temperature exceeds $99^{\circ} \pm 8^{\circ}\text{C}$ due to heater cycling sensor failure. Sensor switch contacts reset closed on decreasing temperature. However, the cockpit heater panel switch must be momentarily placed at **RESET** to restart system operation. Heated air is carried through the cabin via ducts along each side of the cabin at the ceiling.

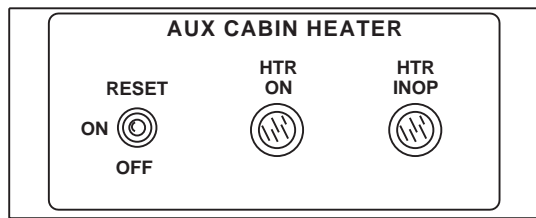

(ON HELICOPTERS EQUIPPED WITH AUXILIARY CABIN HEATER)

LOWER CONSOLE

AA0400
SA

Figure 4-26. Auxiliary Cabin Heater Control Panel

Power to operate the auxiliary cabin heater elements is provided from the No. 1 ac primary bus through the No. 1 junction box and protected by current limiters. Blower power is provided from the No. 2 ac primary bus and protected by a circuit breaker, marked **AUX HTR BLOWER**. Control of both heater elements and blower is provided by power from the No. 1 dc primary bus through a circuit breaker, marked **AUX HTR CONTROL**. The auxiliary cabin heater will operate with APU power on and the backup pump off or with both generators on and the backup pump off.

4.21 ROTOR BLADE DEICE KIT.

Refer to Chapter 2 for description and operation of the blade deice kit.

4.22 EXTERNAL EXTENDED RANGE FUEL SYSTEM KIT. **ERFS**

The external extended range fuel system is supported by the external stores support system extending horizontally from each side of the fuselage aft of the cockpit doors (Figure 4-27). The 230-gallon and 450-gallon jettisonable tanks may be suspended from the vertical stores pylons (VSP). Removable fuel lines, bleed-air lines, valves, and electrical connectors are within the horizontal stores supports (HSS). A tank pressurizing system, using bleed-air, transfers fuel to the main tanks. Fuel lines carrying fuel to the No. 1 and No. 2 main fuel tanks contain check valves to prevent backflow. The extended range system does not supply fuel directly to the engines but is used to replenish the main tanks. Servicing of the external tanks can be done

only through fueling ports on the tanks. Control of the system is provided by a control panel on the lower console. Power to operate the fuel transfer system is provided from the No. 1 dc primary bus through circuit breakers marked **EXT FUEL LH**, and **NO. 1 XFER CONTROL** and from the No. 2 dc primary bus through circuit breakers marked **EXT FUEL RH** and **NO. 2 XFER CONTROL** and from the No. 2 ac primary bus through a circuit breaker marked **AUX FUEL QTY** on the mission readiness circuit breaker panel.

4.22.1 External Extended Range Fuel Transfer Modes.

Fuel can be transferred from external tanks to main tanks in either of two modes, **AUTO MODE** or **MANUAL**. **AUTO** (primary) transfers fuel automatically after switches are manipulated. Fuel transfer will be managed by the microprocessor as described in paragraph 4.22.6. The pilot need only occasionally monitor the **AUXILIARY FUEL MANAGEMENT** panel to ensure that during **AUTO MODE** of fuel transfer, fuel in external tanks is decreasing as it should. The second mode of transfer is the **MANUAL XFR** (secondary) mode. In the **MANUAL** mode the pilot may replenish main tank fuel in any quantity or frequency desired. Transfer must be initiated by the pilot. The pilot must constantly monitor the fuel quantity indicator in order to start and terminate transfer to remain within CG limits. It is possible to transfer fuel from any one tank while in **MANUAL** mode. Transfer is shut off by the pilot when the external tank low-level sensor signals that the tank is empty. During manual transfer, at the illumination of a tank **EMPTY** light, immediately switch from **OUTBD** to **INBD** or to manual transfer **MODE OFF**. Do not wait for the **NO FLOW** light to illuminate. This will preclude air from entering the fuel line and entering the main tank. At the illumination of the **TANK EMPTY** capsule, 2.5 to 4.0 gallons of fuel remain in the tank. Sloshing of the fuel will cause frequent illumination of the **TANK EMPTY**, **NO FLOW**, and **AUX FUEL** lights when the tank is in this condition.

4.22.2 External Extended Range Fuel System Tanks.

External extended range system contains two or four tanks suspended from supports outboard of the fuselage. The tanks contain baffles to prevent fuel sloshing. Quick-disconnect valves are provided in external fuel and bleed-air lines to provide seals when tanks are jettisoned or removed. If tanks are not installed **cccc** will be displayed in the **AUX FUEL QTY POUNDS** display when **OUTBD** or **INBD** is selected on the rotary fuel quantity selector. The preferred location of the External Extended Range Fuel System (External ERFS) auxiliary fuel tank is the outboard pylon. This facilitates ingress and egress of troops, loading of cargo, and the use of the M60D door gun.

4.22.3 Auxiliary Fuel Management Control Panel.

The **AUXILIARY FUEL MANAGEMENT** control panel (Figure 4-27) contains all controls for operating the external extended range fuel system. Controls description is as follows:

CONTROL/ INDICATOR	FUNCTION
FUEL XFR	Controls fuel management of external extended range system.
PRESS	
OUTBD ON	Opens bleed-air valves to outboard tanks for pressurization.
OFF	Closes bleed-air valves to tanks.
INBD ON	Opens bleed-air valves to inboard tanks for pressurization.
OFF	Closes bleed-air valves to tanks.
TANKS INBD	Selects fuel transfer valves from inboard tanks for fuel transfer to main tanks; deselects outboard valves.
TANKS OUTBD	Selects fuel transfer valves from outboard tanks for fuel transfer to main tanks; deselects inboard valves.
MODE	Selects AUTO-OFF-MANUAL mode of fuel transfer from external fuel tanks.
AUTO	Automatically transfers fuel to main tanks from selected external tanks, until empty sensor in each tank interrupts transfer. Transfer occurs in levels as shown under fuel transfer sequence. When tanks are empty, NO FLOW and EMPTY indicators and AUX FUEL caution light will be turned on.
OFF	Interrupts automatic or manual transfer mode of operation.
MANUAL	Provides electrical path to MANUAL XFR switch(es), which allows transfer from selected tank(s) until switch is moved to off.

CONTROL/ INDICATOR	FUNCTION
MANUAL XFR	
RIGHT ON	Transfers from right tank used in conjunction with MODE switch in MANUAL position of the pair selected by TANKS select switch.
OFF	Interrupts transfer operation.
LEFT ON	Transfers from left tank of the pair selected by TANKS select switch.
OFF	Interrupts transfer operation.
AUX FUEL QTY POUNDS	Indicates pounds of external fuel remaining in symmetrical pair of tanks total of auxiliary tanks, self-test indication or failure codes. Displays K factors of flow meter.
NOTE	
	Fuel tanks selector and quantity indicators are also used in conjunction with INCR-DECR switch when initializing fuel quantity of tanks.
OUTBD	Total pounds of fuel remaining in outboard pair of tanks.
INBD	Total pounds of fuel remaining in inboard pair of tanks.
TOTAL	Pounds of fuel remaining in all external extended range tanks.
CAL	Adjusts K factor of flow switch on AUXILIARY FUEL MANAGEMENT panel.
INCR switch position	Increases setting of digital readout to adjust for fuel remaining in tanks selected by fuel tank selector.
DECR switch position	Decreases setting of digital readout to adjust for fuel remaining in tanks selected by fuel tank selector.
STATUS button	Resets AUX FUEL caution light and stores condition of NO FLOW and EMPTY indicators.

CONTROL/ INDICATOR	FUNCTION
TEST	Checks display and indicator lights. Performs memory checksum, displays 8 sequentially in each digital display. Verifies that temperature probe is connected; verifies that flow meter is connected; performs trial calculation based on a known temperature and flow meter input, compares it with a known good value, and displays setting of fuel density switch. At completion of test, GOOD or error code will be displayed (Table 4-3).
DEGRADED light	Error in critical function has occurred. Error code will be displayed as shown under TEST . Only E02 error will allow microprocessor to clear failure code and regain fuel remaining information by doing two self-tests.
EXTERNAL	
*RIGHT NO FLOW light	Fuel flow does not exit from selected right tank.
*INBD EMPTY light	Right inboard tank fuel exhausted.
*OUTBD EMPTY light	Right outboard tank fuel exhausted.
*LEFT NO FLOW light	Fuel flow does not exit from selected left tank.
*INBD EMPTY light	Left inboard tank fuel exhausted.
*OUTBD EMPTY light	Left outboard tank fuel exhausted.
VENT SENSOR	Detects the presence of fuel on the vent thermistor.
*OVFL	Indicates fuel venting overboard.

CONTROL/ INDICATOR	FUNCTION
	NOTE
	Illumination of this capsule on the Fuel Management Panel will cause illumination of the AUX FUEL caution light and the MASTER CAUTION light. Pushing the STATUS button will reset the NO FLOW , AUX FUEL and the MASTER CAUTION lights, but does not correct the no flow condition.
FAIL	Open in vent sensor line.

4.22.4 External Extended Range Fuel Quantity Indicating System. The **AUX FUEL QTY POUNDS** digital readout (Figure 4-27) displays the amount of fuel remaining. Fuel type is preset by switches in the **AUXILIARY FUEL MANAGEMENT** panel. Preset can only be done when the helicopter weight is on the wheels. When measuring quantity, the readout is used in conjunction with the rotary selector switch to select tank pair subtotal, or **TOTAL** remaining in all tanks. Fuel used is sensed from a common flow transmitter within the fuel line to the main tanks. This amount is subtracted from the preset fuel quantity input and is displayed on the digital readout as pounds remaining. A **DEGRADED** light will go on when a complete failure has occurred in the microprocessor, or an error condition is detected by the microprocessor, or when the temperature sensor has failed. Power for the fuel quantity subsystem is provided from the No. 2 ac primary bus through a circuit breaker marked **AUX FUEL QTY**, on the mission readiness circuit breaker panel.

4.22.5 Auxiliary Fuel Management Control Panel Test.

1. **TEST** button - Press. Digits should display 8's, all panel lights and **DEGRADED** and **VENT SENSOR (FAIL and OVFL)** lights should illuminate.

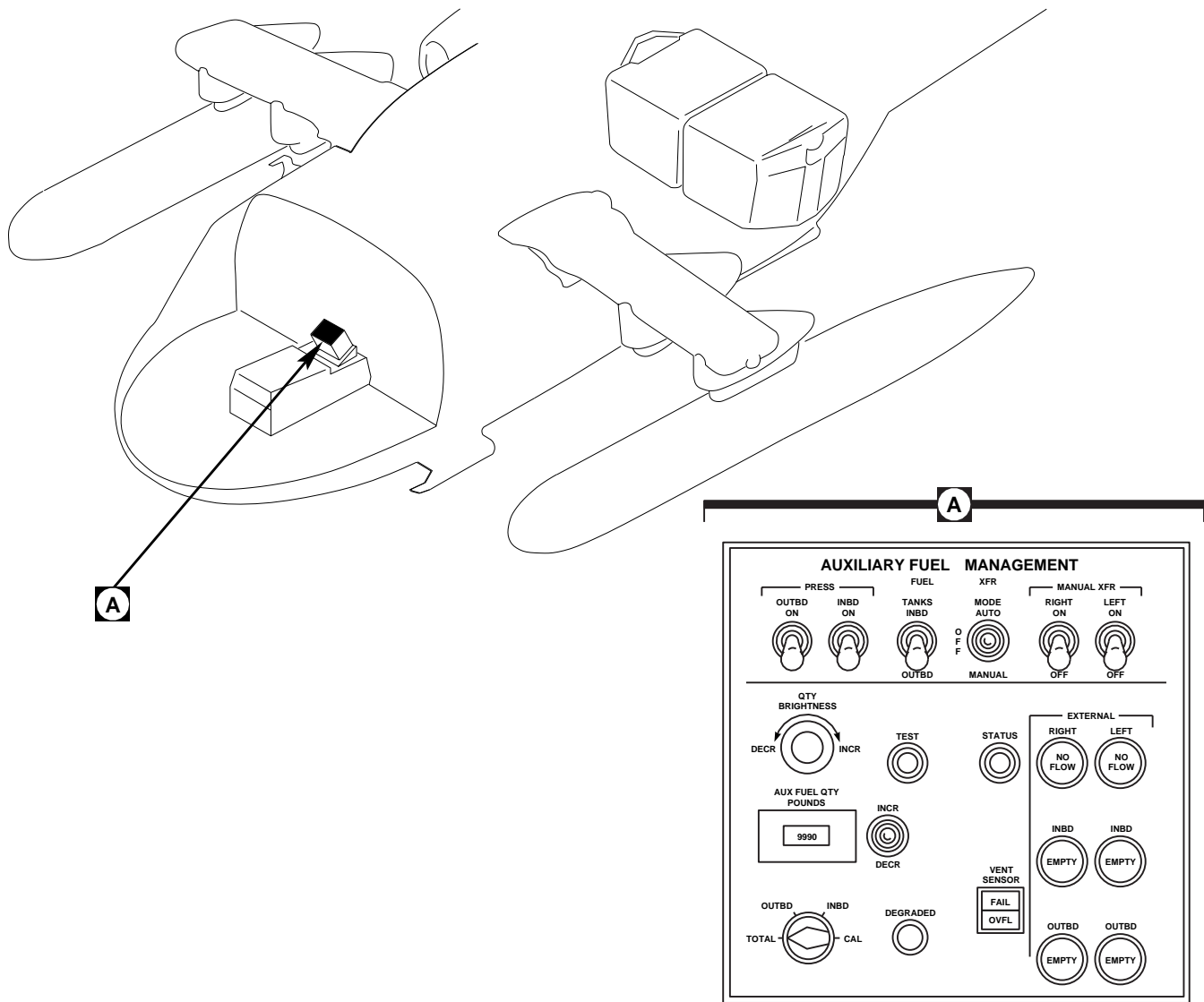

AA0665
SA

Figure 4-27. Auxiliary Fuel Management Control Panel

2. **TEST** button - Release. Digits should display 8's in sequence from left to right three times; 5 seconds later, display GOOD or EO failure code; 3 seconds later, display type fuel density, then fuel **TOTAL**.
3. Deleted.
4. Auxiliary fuel quantity switch - **CAL**.

NOTE

CAL is the calibration value marked on the fuel flow transmitter. Enter the four digit number, disregarding the numbers to the right of the decimal point.

5. **INCR/DECR** switch - Set calibration.

- 6. Auxiliary fuel quantity switch - **INBD**.
- 7. **INCR/DECR** switch - Set inboard fuel quantity.
- 8. Auxiliary fuel quantity switch - **OUTBD**.
- 9. **INCR/DECR** switch - Set outboard fuel quantity.
- 10. Auxiliary fuel quantity switch move to **TOTAL** - Check.
- 11. **PRESS OUTBD** and **INBD** switches - As desired.

4.22.6 Fuel Transfer Sequence.



FUEL BOOST PUMP CONTROL switches shall remain on during external range fuel transfer and remain on for 10 minutes after PRESS switches are moved to OFF. Failure to observe this warning may cause engine flameout.



Fuel transfer sequence must be carefully planned and executed in order to maintain CG within limits.

Fuel transfer sequence shall be based on mission requirement and center of gravity limitations. Automatic transfer is started when the proper switches are manipulated and fuel level is as shown below and external range tanks internal pressure is increased enough to force fuel to the main tanks. Transfer will continue until the main tank signal conditioner provides a signal through the microprocessor to stop fuel transfer. This cycle is done as required until interrupted by placing the **MODE** switch to **OFF** or **MANUAL** or placing the **PRESS** switch **OFF**. Manual transfer will be started on selection of **MANUAL** and appropriate switches, and external fuel tanks are bleed-air pressurized to start fuel transfer from external tank(s) to main tanks. Transfer will continue until tanks are full. They will remain full as long as the manual mode remains en-

gaged. Manual transfer requires close monitoring of fuel level to initiate and stop transfer to remain within CG limits. The automatic transfer sequence is as follows:

TOTAL AUXILIARY FUEL REMAINING (BASED ON JP- 4 DENSITY)	TRANSFER START WHEN ONE MAIN FUEL TANK QUANTITY LESS THAN	TRANSFER STOP WHEN EACH MAIN FUEL TANK QUANTITY MORE THAN
8840-7041 lbs	950 lbs	1000 lbs
7040-5001 lbs	750 lbs	1000 lbs
5000-0 lbs	600 lbs	1000 lbs

4.22.7 External Extended Range Fuel Transfer Check.

NOTE

When ambient temperature is below 4°C (40°F), ESSS/ERFS shall not be turned off after transfer check has been completed to avoid potential for freeze-up of the pressure regulator.

- 1. **AIR SOURCE HEAT/START** switch - **ENG**.
- 2. **FUEL BOOST PUMP CONTROL** switches - Check **ON**.



FUEL BOOST PUMP CONTROL switches shall remain on during external range fuel transfer and remain on for 10 minutes after PRESS switches are moved to OFF. Failure to observe this warning may cause engine flameout.

- 3. **PRESS OUTBD** and **INBD** switches - **ON** for tanks installed.
- 4. Fuel quantity switch - **TOTAL**.
- 5. **TANKS** switch - As desired.
- 6. **MODE** switch - **MANUAL**.

7. **MANUAL XFR RIGHT** switch - **ON**.
8. Main **FUEL QTY TOTAL FUEL** readout - Check for increase of about 20 pounds.
9. **TANKS** switch - Repeat for other position.
10. **MANUAL XFR RIGHT** switch - **OFF**.
11. **MANUAL XFR LEFT** switch - **ON**.
12. Repeat steps 8. and 9. for **MANUAL XFR LEFT**.
13. **MANUAL XFR** switches - **OFF**.
14. External extended range fuel system - Set as desired.

4.22.7.1 External Extended Range Fuel Transfer In AUTO Mode.

NOTE

If either main fuel quantity is below 1,000 lbs., selecting the automatic mode may initiate a transfer sequence.

Allow sufficient time for tank pressurization (approximately 10 minutes for a half full 230-gallon tank).

During transfer, periodically verify that **AUXILIARY FUEL MANAGEMENT** panel quantity is decreasing at a minimum of 40 pounds per minute, per tank pair. Fuel transfer rate of less than 40 pounds per minute may indicate reduced flow from one or both tanks.

1. **AIR SOURCE HEAT/START** switch - **ENG**.
2. **FUEL BOOST PUMP CONTROL** switches - **ON**.
3. **PRESS OUTBD** and **INBD** switches - **ON** for tank sets installed.
4. **MODE** switch - **AUTO**.
5. **TANKS** switch - **OUTBD**. Switch to **INBD** after outboard tanks are empty.

4.22.7.2 External Extended Range Fuel Transfer In MANUAL Mode.

If **AUTO** mode is inoperative, transfer in **MANUAL** mode as follows:



Monitor fuel transfer to remain within CG limits and avoid asymmetric loading.

1. **AIR SOURCE HEAT/START** switch - **ENG**.
2. **FUEL BOOST PUMP CONTROL** switches - **ON**.
3. **PRESS OUTBD** and **INBD** switches - **ON** for tank sets installed.
4. **MODE** switch - **MANUAL**.
5. **TANKS** switch - **OUTBD**. Switch to **INBD** after outboard tanks are empty.
6. **MANUAL XFR** switches **RIGHT** and **LEFT** - **ON**.

4.22.7.3 External Extended Range Fuel Flow Verification In Manual Mode. If extended range without landing is required and the aircraft is not equipped with an ERFS fuel indicating system, verify fuel flow from each tank as follows:

NOTE

Ensure main fuel tanks are not completely full.

1. **AIR SOURCE HEAT/START** switch - **ENG**.
2. **FUEL BOOST PUMP CONTROL** switches - **ON**.
3. **PRESS OUTBD** and **INBD** switches - **ON** for tank sets installed.
4. **MODE** switch - **MANUAL**.
5. **TANKS** switch - **OUTBD**. Switch to **INBD** after outboard tanks are empty.
6. **MANUAL XFR RIGHT** switch - **ON**. Note the rate of decrease of the **AUX FUEL QTY**

POUNDS indicator. The normal transfer fuel flow rate per tank should be between 20 to 38 pounds per minute.

7. **MANUAL XFR RIGHT** switch - **OFF**.

8. Repeat steps 6. and 7. for left tank.

4.22A EXTERNAL AUXILIARY FUEL MANAGEMENT SYSTEM. AFMS

The external extended range fuel system is supported by the external stores support system. The 230-gallon and 450-gallon jettisonable tanks may be suspended from the vertical stores pylons (VSP). Removable fuel lines, bleed-air

Table 4-3. Extended Range Fuel System Degraded Operation Chart ERFs

SYSTEM FAILURE CODES AND INDICATIONS	DEGRADED LIGHT	AUX FUEL CAUTION LIGHT	DESCRIPTION OF DEGRADED OPERATION
E01 MICROPROCESSOR ERROR E03 FLOWMETER DISCONNECTED E04 ERROR FUEL FLOW CIRCUITS E05 ERROR FUEL FLOW COMPUTATION E06 MEMORY ERROR	ON	ON	1. AUTO XFR CAPABILITIES REMAIN 2. DEFAULTS TO CURRENT XFR SCHEDULE 3. PILOT MUST COMPUTE FUEL USAGE
E02 TEMPERATURE SENSOR NOT CONNECTED OR OUT OF RANGE	ON	ON	1. AUTO XFR CAPABILITIES REMAIN 2. PERFORMING TWO SELF-TESTS WILL: A. CLEAR FAILURE CODE AND REGAIN FUEL REMAINING INFO B. RESET AUX FUEL LIGHT C. DEFAULT TO PRESELECTED TEMP VALUE
LOSS OF DIGITAL READOUT	ON	ON	1. AUTO XFR CAPABILITIES REMAIN 2. NO FLOW AND EMPTY MONITORING INDICATIONS REMAIN 3. PILOT MUST COMPUTE FUEL USAGE
LOSS OF ONE MAIN TANK LEVEL QUANTITY SENSOR OR LOSS OF ONE SIGNAL CONDITIONER INPUT	OFF	OFF	NO DEGRADATION
FAILED AUX TANK EMPTY SENSOR PROVIDES FALSE EMPTY SIGNAL	OFF	ON-IF FUEL TRANSFER SELECTED	AUX TANK FUEL TRANSFER SHUTOFF VALVE CLOSES. PILOT SELECTING MANUAL MODE REOPENS VALVE.

lines, valves, and electrical connectors are within the horizontal stores supports (HSS). A tank pressurizing system, using bleed-air, transfers fuel from the external tanks to the main tanks. Fuel lines carrying fuel to the No. 1 and No. 2 main fuel tanks contain check valves to prevent backflow. The external tanks are gravity refueled only. Control of the system is provided by a auxiliary fuel management panel (AFMP) located in the center of the instrument panel. Dimming control for the AFMP panel lighting is provided by the cockpit **INST LT NON FLT** rheostat on the upper console. Dimming control for all fuel quantity displays and annunciators on the AFMP is provided by the **LIGHTED SWITCHES** rheostat on the upper console only when the caution/advisory panel is in the **DIM** mode. Power for the auxiliary fuel management system is provided from the No. 2 dc primary bus through circuit breakers marked **EXT FUEL RH** and **NO. 2 XFER CONTROL** on the mission readiness circuit breaker panel.

4.22A.1 External Auxiliary Fuel Management System. This system contains two or four tanks suspended from supports outboard of the fuselage. The tanks contain baffles to prevent fuel sloshing. Quick-disconnect valves are provided in external fuel and bleed-air lines to provide seals when tanks are jettisoned or removed. If tanks are not installed, the fuel quantity display for the removed tank is blank when the **XFER MODE** is **OFF**. When the **XFER MODE** switch is in any other position, the removed tank display will show **NT**.

4.22A.2 Auxiliary Fuel Management Control Panel (AFMP). The AFMP (Figure 4-27.1) contains all controls for operating the external extended range fuel system. Controls description is as follows:

CONTROL/ INDICATOR	FUNCTION
PRESS switch	Provides control of bleed air pressurization of auxiliary tanks.
PRESS	
ALL	Opens bleed-air valves to all installed tanks for pressurization.
OUTBD	Opens bleed-air valves to outboard tanks for pressurization.
INBD	Opens bleed-air valves to inboard tanks for pressurization.

CONTROL/ INDICATOR	FUNCTION
OFF	Closes bleed-air valves to tanks.
XFER FROM	
INBD	Selects fuel transfer from inboard tanks.
OUTBD	Selects fuel transfer from outboard tanks.
XFER MODE	Selects AUTO-OFF-MAN mode of fuel transfer from external fuel tanks.
AUTO	Activates automatic fuel transfer.
OFF	Closes all fuel transfer valves. Interrupts automatic or manual transfer mode of operation. Deactivates NO FLOW indicators.
MAN	Selects manual transfer mode. Activates MAN XFER switches.
MAN XFER	
LEFT	Transfers from left inboard or outboard tank.
BOTH	Transfers from both left and right inboard or outboard tanks.
RIGHT	Transfers from right inboard or outboard tank.
AUX FUEL QTY LBS	
L OUTBD	Pounds of fuel remaining in the left outboard tank to the nearest 10 lbs.
L INBD	Pounds of fuel remaining in the left inboard tank to the nearest 10 lbs.
R OUTBD	Pounds of fuel remaining in the right outboard tank to the nearest 10 lbs.
R INBD	Pounds of fuel remaining in the right inboard tank to the nearest 10 lbs.

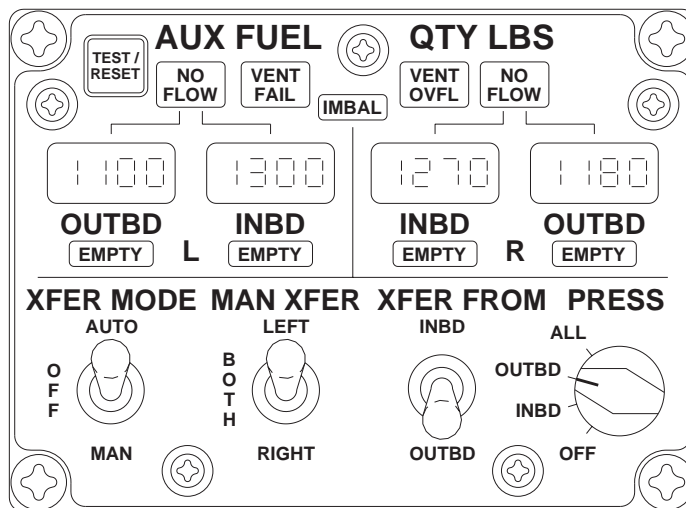

AB0820
SA

Figure 4-27.1. Auxiliary Fuel Management Control Panel **AFMS**

**CONTROL/
INDICATOR**

TEST/RESET

FUNCTION

On the ground (weight on wheels) - Activates the Initiated Built in Test (IBIT) and conducts a lamp test of all displays and indicator lights. System malfunctions are displayed from left to right in the fuel quantity displays, using the error codes (Table 4-4). Fuel quantity displays return after the lamp test, if no errors are identified. Acknowledges **E04** through **E07** error codes.

In-flight (weight off wheels) - Resets **AUX FUEL** caution light and **MASTER CAUTION** but does not correct the condition.

NOTE

Illumination of annunciators on the AFMP will activate **AUX FUEL** caution light and **MASTER CAUTION** lights.

**CONTROL/
INDICATOR**

FUNCTION

The **NO FLOW** condition must exist for 5 seconds before the **AUX FUEL** caution light and **MASTER CAUTION** lights are activated.

One of these indications will occur if a tank empty sensor fails (for related tank).

- A false **EMPTY** light (tank shows quantity greater than zero).
- A false **NT** fuel quantity indication (tank installed, **AUTO** or **MAN** mode selected).
- A false "blank" fuel quantity indication (tank installed, **XFER MODE** is **OFF**).
- Degraded operation for the above conditions: **AUTO** mode is disabled, use **MAN** mode.

**AUX FUEL QTY
LBS**

CONTROL/ INDICATOR	FUNCTION
*R NO FLOW light	No fuel flowing from right tank(s).
*R INBD EMPTY light	Right inboard tank fuel exhausted.
*R OUTBD EMPTY light	Right outboard tank fuel exhausted.
*L NO FLOW light	No fuel flowing from left tank(s).
*L INBD EMPTY light	Left inboard tank fuel exhausted.
*L OUTBD EMPTY light	Left outboard tank fuel exhausted.

NOTE

EMPTY light will only activate **AUX FUEL** caution light and **MASTER CAUTION** lights when its tank is selected for transfer.

If the **EMPTY** light is on for more than 10 seconds and the fuel quantity display is greater than zero, the tank empty sensor has failed.

VENT FAIL lights	Vent sensor inoperative.
* VENT OVFL lights	Indicates when AFMS detects the presence of fuel in vent line.
* IMBAL light	Indicates a lateral imbalance of 400 to 680 pounds between fuel quantity indications for outboard tanks.

4.22A.3 External Auxiliary Fuel Management Quantity Indicating System.

AFMS The **AUX FUEL QTY LB** digital readout indicates (Figure 4-27.1) the amount of fuel in each of the installed external tanks in ten pound increments. A fuel probe in each of the external tanks sends a signal to the AFMP proportional to the fuel level in the tank. The level of fuel at the probe varies significantly with tank attitude. Aircraft body pitch angle data from the copilot's vertical gyro is used by the AFMP so that the fuel quantity displayed includes compensation for angles between 10° nose down and 1° nose up. **E07** will result in a drop in **AUX** fuel quantities for pitch down attitudes. A pitch up attitude may result in a slight increase. The copilot's attitude indicator will not indicate **OFF** if the **E07** error code occurs due to failure of AFMP circuits external to the gyro. The pilot's vertical gyro is not connected

to the AFMP and therefore not available for attitude compensation. Level flight provides most accurate fuel quantity. A filter is incorporated in the AFMP software to minimize fuel quantity variations due to fuel slosh during maneuvering flight.

NOTE

The AFMP may display fuel quantities of up to 150 pounds below the actual fuel quantity per tank due to tank angle when the helicopter is on the ground.

A lateral imbalance is defined as any difference in fuel quantity readings between tank pairs greater than 400 pounds. The crew should not wait for the illumination of the **IMBAL** light to begin correcting the lateral imbalance condition.

The AFMP has three built in test (BIT) functions; power up (PBIT), initiated (IBIT), and continuous (CBIT). PBIT and IBIT are disabled in-flight by the WOW interlock. Circuits tested and related error codes are shown in Table 4-4. PBIT is initiated when power is applied or reapplied to the AFMP. IBIT is initiated by pressing the **TEST/RESET** button for one second or more. CBIT is activated at the completion of PBIT or IBIT and runs continuously.

NOTE

The transition from APU to main generators during engine run up can cause the PBIT to be initiated. The AFMP will display fuel quantities once the PBIT functions are completed.

4.22A.4 Modes of Operation.

4.22A.4.1 Automatic Mode Fuel Transfer.

WARNING

FUEL BOOST PUMP CONTROL switches shall remain on during external range fuel transfer and remain on for 10 minutes after PRESS switch is moved to OFF. Failure to observe this warning may cause engine flameout.

CAUTION

Monitor fuel transfer to remain within CG limits and avoid asymmetric loading.

The fuel transfer sequence shall be based on mission requirements and center of gravity limitations. Automatic transfer is controlled by the AFMP sensing the No. 1 and 2 main tank fuel quantities to start and stop fuel transfer. When **AUTO** mode is selected, transfer starts when the fuel level in either main tank falls below 1,000 pounds, and the external tanks are pressurized. The **NO FLOW** lights may flicker upon initiation of fuel transfer. The AFMP transfers fuel from both tanks selected with the **XFER FROM** switch regardless of the position of the **MAN XFER** switch. Fuel transfer stops when the **TOTAL FUEL** quantity indicates 2,200 pounds or when the **EMPTY** light on either tank or **VENT OVFL** light illuminates on the AFMP.

4.22A.4.2 Manual Mode Fuel Transfer. AFMS

WARNING

FUEL BOOST PUMP CONTROL switches shall remain on during external range fuel transfer and remain on for 10 minutes after PRESS switch is moved to OFF. Failure to observe this warning may cause engine flameout.

CAUTION

Monitor fuel transfer to remain within CG limits and avoid asymmetric loading.

If the IMBAL indicator illuminates, the crew should verify selection of the heavy tank and closely monitor the fuel quantity displays on the AFMP. No additional warnings are provided by the AFMP or caution advisory system if the crew selects the wrong tank with the MAN XFER switch.

Manual transfer requires close monitoring of the main fuel quantity and AFMP fuel quantity displays to remain within CG limits and maintain lateral balance. Manual

mode is initiated by the pilot when the **XFER MODE** switch is placed to **MAN** and external tanks are pressurized. Fuel transfer will continue as long as **MAN** is selected. The **NO FLOW** lights will randomly flicker as fuel is transferred until the main fuel quantity reaches approximately 2,300 pounds, unless the **XFER MODE** switch is placed to **OFF** or **AUTO**. The **NO FLOW** condition results when the tank pressurization can no longer add fuel to the tanks due to activation of the high level fuel shutoff valves in the main tanks. Illumination of the **EMPTY** light alerts the pilot to change tank pairs using the **XFER FROM** switch, select another tank using the **MAN XFER** switch, or place the **XFER MODE** switch to **OFF**. To avoid pumping air into the main tanks, do not wait for the **NO FLOW** light to illuminate. Sloshing of the fuel will cause frequent illumination of the **EMPTY** light only when the tank is selected for fuel transfer. Sloshing of fuel and activation of the fuel transfer valves using the **XFER MODE** switch can cause flickering of the **NO FLOW** light; however the **AUX FUEL** and **MASTER CAUTION** will only illuminate if the **NO FLOW** lights remain illuminated for more than 5 seconds. If lateral imbalance results during fuel transfer, the AFMP senses the imbalance and illuminates the **IMBAL** light. The lateral imbalance can be resolved by selecting fuel transfer from the heavy tank. The **IMBAL** light illuminates with approximately 685 pound difference between outboard tanks, and will remain illuminated until the lateral imbalance is reduced below approximately 450 pound difference between outboard tanks.

4.22A.5 Auxiliary Fuel Management Control Panel - TEST. AFMS

1. **AUX FUEL QTY** digital readouts - Note current reading.
2. **TEST/RESET** button - Press. All annunciators will light and **E07** will be displayed, if test is initiated within approximately one minute of applying ac power. If **E07** appears, press **TEST/RESET** again. **E07** should not appear until test is finished.
3. **BIT** indications - Check. Fuel quantity displays will appear upon completion of **BIT**. The pitch attitude sensor error **E07** test has a 5 minute delay to allow the vertical gyro to obtain full operating speed.
4. **PRESS** switch - As desired for tanks installed.

4.22A.6 Fuel Transfer Check. AFMS**NOTE**

When ambient temperature is below 4° C (39° F), ERF/AFMS shall not be turned off after transfer check has been completed to avoid potential freeze up of the pressure regulator.

1. **AIR SOURCE HEAT/START** switch - **ENG.**
2. **FUEL BOOST PUMP CONTROL** switches - **ON.**

WARNING

FUEL BOOST PUMP CONTROL switches shall remain on during external range fuel transfer and remain on for 10 minutes after PRESS switch is moved to OFF. Failure to observe this warning may cause engine flameout.

3. **PRESS** switch - As required for tanks installed.
4. **XFER FROM** switch - **OUTBD.**
5. **MAN XFER** switch - **BOTH.**
6. **XFER MODE** switch - **MAN.**
7. Main **FUEL QTY TOTAL FUEL** readout - Check for increase of approximately 40 pounds and **AUX FUEL QTY LBS** decrease 20 pounds per tank.
8. **XFER FROM** switch - **INBD** if installed.
9. Main **FUEL QTY TOTAL FUEL** readout - Check for increase of approximately 40 pounds and **AUX FUEL QTY LBS** decrease 20 pounds per tank.
10. **XFER MODE** switch - **OFF.**
11. External extended range fuel system - Set as desired.

4.22A.6.1 Fuel Transfer in AUTO mode. AFMS**NOTE**

Allow sufficient time for tank pressurization (approximately 10 minutes for a half full 230 gallon tank).

During transfer, periodically verify the **TOTAL FUEL** quantity remains above 2,000 pounds and the selected tank pair remains in balance. A decrease below 2,000 pounds on the **TOTAL FUEL** quantity display or the generation of an imbalance in the **AUTO** mode may indicate reduced flow from one or both of the external tanks selected.

1. **AIR SOURCE HEAT/START** switch - **ENG.**
2. **FUEL BOOST PUMP CONTROL** switches - **ON.**
3. **PRESS** switch - As required for tanks installed.
4. **XFER FROM** switch - **OUTBD**, then **INBD.**
5. **XFER MODE** switch - **AUTO.**

4.22A.6.2 Fuel Transfer in MANUAL mode. AFMS

If the **AUTO** mode is inoperative or a lateral imbalance greater than 400 pounds between tank pairs is identified, transfer in the **MAN** mode as follows:

CAUTION

Monitor fuel transfer to remain within CG limits and avoid asymmetric loading.

1. **AIR SOURCE HEAT/START** switch - **ENG.**
2. **FUEL BOOST PUMP CONTROL** switches - **ON.**
3. **PRESS** switch - As required for tank sets installed.
4. **XFER FROM** switch - **OUTBD**, then **INBD.**
5. **MAN XFER** switch - **BOTH** or select heavy tank to correct an imbalance.

6. XFER MODE switch - MAN.

4.23 EXTERNAL STORES SUPPORT SYSTEM (ESSS). ES

ESSS provides a means of carrying a variety of external stores, including external extended range fuel tanks. The ESSS consists of fixed and removable provisions.

4.23.1 External Stores Fixed Provisions. Fixed provisions are: upper fuselage fixed fittings for attaching the horizontal stores support (HSS) subsystem, and lower fuselage strut support fittings for attaching two struts for each HSS. In addition to exterior components, fixed provisions are: interior helicopter provisions, including electrical harnesses, fuel lines, bleed-air lines, and circuit breakers.

4.23.2 External Stores Removable Provisions. The external stores removable subsystem extends horizontally from each side of the helicopter at station 301.5, buttline 42.0. Extending below each horizontal stores support (HSS) are two vertical stores pylons (VSP) and attaching ejector racks. The racks are used to attach fuel tanks or other external stores dispensers.

4.23.3 ESSS Side Position Lights. A position light is on each outboard end of HSS. Those lights use the power source provided to operate the standard installed position lights, colors are the same. Upon installation of the HSS, the electrical connectors connected to the jumper plugs, providing power for the standard position lights, are removed and reconnected to the connectors from the HSS

Table 4-4. Auxiliary Fuel Management System Fault Messages AFMS

SYSTEM FAILURE CODES AND/OR INDICATIONS	DESCRIPTION OF DEGRADED OPERATIONS
<p>E01 - AFMP microprocessor fail E02 - AFMP memory fail E03 - AFMP display fail</p>	<p>1. E01-E03 error codes displayed continuously if failure occurs during PBIT or IBIT on the ground (WOW only). 2. Only MAN mode for transfer is available.</p>
<p>E04 - AFMP tank gaging electronics failure E05 - Auxiliary tank probe (OPEN) E06 - Auxiliary tank probe (SHORT)</p>	<p>1. Error codes display during PBIT or IBIT if failure occurs on the ground (WOW only). 2. Acknowledge failure by pressing TEST/RESET button and error code changes to the CBIT display (---) or FP. 3. Manual mode only is available for the tank pair selected. Fuel quantity must be calculated for the tank with the failure.</p>
<p>(---) AFMP tank gaging electronics failure. FP - Auxiliary tank probe circuit failure (open or short). NF - No tank detected.</p>	<p>1. (---) is the failure indication for error code E04 and FP is the failure indication for E05 and E06 during CBIT on the ground or in flight or during PBIT or IBIT on the ground after the crew acknowledges the error using TEST/RESET. 2. Manual mode only is available for the tank pair with the failure. Fuel quantity must be calculated for the tank with the failure. 3. No tank detected by sytem, when that tank is selected for transfer.</p>
<p>E07 - AFMP memory fail</p>	<p>1. May occur on the ground if IBIT is initiated within approximately 1 minute of applying ac power to the aircraft. Acknowledge E07 with the TEST/RESET button. 2. If E07 is observed in flight or persists on the ground, AUTO and MAN mode are available but the pitch attitude correction defaults to a level attitude regardless of flight condition.</p>

position lights. Operation and power source for the ESSS position lights are the same as for the standard installed position lights.

4.23.4 External Stores Jettison Control Panel. The jettison control panel (Figure 4-28) provides the capability of phase jettison of all external stores or symmetrical jettison of fuel tanks. Interlock circuitry prevents jettison of fuel tanks other than in pairs. Emergency jettison is completely independent of the primary jettison subsystem.



The BRU-22A/A and MAU-40/A Ejector Rack CARTRIDGES are explosive devices and must not be exposed to heat, stray voltage or static electricity. Refer to TM 9-1300-206 for information concerning handling and storage of ammunition.

The jettison control panel (Figure 4-28) contains all controls for jettisoning external stores. Jettison controls are as follows:

CONTROL	FUNCTION
EMER JETT ALL	Applies 28 volts from essential dc bus to all stores stations when the helicopter weight is off the wheels, regardless of the rotary selector switch. A 1-second time delay permits the outboard stations to jettison before the inboard stations.
Rotary selector switch	Determines which station receives primary jettison signal.
OFF	Prevents jettison signal from going to any stores station.
INBD	
L	*Directs jettison signal to inboard left station.
R	*Directs jettison signal to inboard right station.
BOTH	Directs jettison signal to inboard left and right stores stations.

CONTROL	FUNCTION
OUTBD	
L	*Directs jettison signal to outboard left station.
R	*Direct jettison signal to outboard right station.
BOTH	Directs jettison signal to outboard left and right stores stations.
ALL	Directs primary jettison signal to all stores stations. Outboard stores will jettison and 1 second later inboard stores will jettison.

NOTE

*If fuel tanks are connected to the left, right, or both stores stations, the **BOTH** mode of jettison is automatically selected even if the selector switch is at **L** or **R**.

JETT	Applies 28 volts from primary dc bus through the rotary selector switch to the selected stores station if the weight is off the wheels and the selector switch is not OFF .
-------------	--

4.23.5 Stores Jettison Control Operation.



To prevent unintentional jettison of external stores when the helicopter weight is on the wheels, do not actuate any jettison switch.

The jettison system provides two modes of jettisoning external stores, primary and emergency. The primary subsystem uses the rotary selector switch and the **JETT** toggle switch. The emergency jettison subsystem uses only the **EMER JETT ALL** toggle switch. Primary jettison is used

AA0664
SA

Figure 4-28. Stores Jettison Control Panel **ES**

when selective jettison is desired. The rotary switch is used to select the stores point for release, and the **JETT** toggle switch is used to actuate the release. Emergency jettison is used to release all external stores through one actuation of the **EMER JETT ALL** toggle switch, regardless of rotary switch position. During primary (rotary switch **ALL** selected) and emergency jettison, a 1-second delay is provided after the outboard stores are released, before the inboard stores will be released. When one pair of tanks is jettisoned in a four tank system, **cccc** will appear on the **AUX FUEL QTY POUNDS** digital readout when the corresponding fuel quantity position is selected. The fuel remaining in the tanks jettisoned will be subtracted from the total displayed when **TOTAL** is selected. Power to operate the primary jettison subsystem is from the No. 1 dc primary bus through circuit breakers marked **ESSS JTSN INBD** and **OUTBD**. The emergency jettison subsystem is powered from the dc essential bus through circuit breakers marked **ESSS JTSN INBD** and **OUTBD**.

4.24 RAPPELING ROPE CONNECTORS.

Rappeling rope connectors consist of four cabin ceiling tie down fittings.

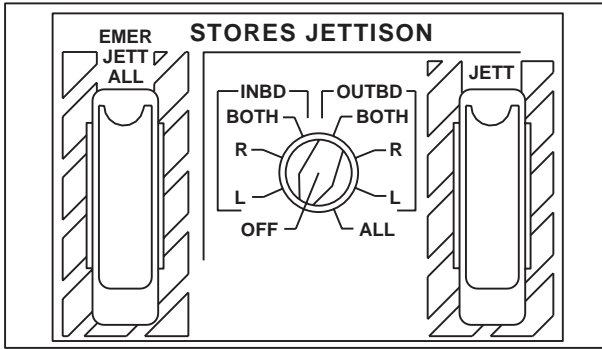
4.25 MEDICAL EVACUATION (MEDEVAC) KIT.

WARNING

Use of the medevac pedestal ambulatory configuration for transport of personnel other than patients or essential medical personnel is prohibited.

A medevac kit consisting of a pedestal support assembly and provisions for three rear-facing troop seats may be installed in the UH-60 helicopter (Figure 4-29) after removing the existing troop seats. The medevac pedestal assembly, when installed, is directly below the main transmission. The pedestal can be turned about a vertical axis. Litter supports are cantilevered from the pedestal. The litter supports may be positioned to accept four to six litter patients, up to six ambulatory patients or essential medical personnel, or combination thereof. The pedestal should be positioned along the longitudinal axis of the helicopter for flight, to provide maximum crash attenuation. The pedestal contains restraint belts for each litter, restraint lap belts for each ambulatory occupant, eight individually operated lights for the four-man litter configuration, provisions for eight 1000 ml. intravenous fluid bags, and provisions for two size D oxygen bottles. Another feature of the medevac kit is a 115 vac, 60 Hz frequency converter to provide electrical power for use of standard hospital equipment. On missions not requiring electrical power, the power pack may be left out. The three-man rear-facing seat provisions are in the forward portion of the cabin, and accommodate standard troop seats. The four man litter configuration allows rotation of the pedestal so that the litter patients can be loaded from either side of the helicopter. The six-man litter configuration also allows for side loading: however, the pedestal must be rotated back to the locked position along the longitudinal axis of the helicopter after four litters are loaded. Floor restraints are then installed to the cabin floor tiedown studs on both sides of the pedestal. The last two litters are placed on both sides of the pedestal between the floor restraints and secured. Only the upper supports are capable of being tilted for loading or unloading of the litters. Unloading the patients is the reverse of loading. To convert to the six-man ambulatory patient or essential medical personnel configuration, the upper litter supports are folded down to accommodate three patients or essential medical personnel seated side by side on either side of the pedestal. The medevac pedestal ambulatory configuration provides significantly less crashworthiness capability (energy attenuation and occupant restraint) than the troop seats.

4.25.1 Litter Support. Each litter support is attached to the center pedestal by two end pivot shafts, (Figure 4-29) and by two T-shaped fittings, which allows removal, interchange, or repositioning of the supports. Crashload absorption works on the deformation principal. There are five pivot shaft support holes on the right and left side of the center console at both ends. Behind the holes are support rollers for the pivot shafts. From top to bottom, the top hole is provisions for the upper litter in the six-litter configuration. The second hole is for the upper litter support of a four-litter configuration. These end holes line up with a central pivot shaft on the litter support. Only this litter po-

sition allows midposition pivoting for loading or unloading. The third hole is for the center litter of the six-litter configuration. The fourth hole is used when installing the litter support in the four-litter configuration. The third, fourth, and fifth positions do not provide a tilt function.

4.25.2 Litter Lighting. Two litter lights are installed in the pedestal at each litter (Figure 4-29). Each light contains a **PUSH-ON, PUSH-OFF** switch. The positioning of those lights is adjustable. Power to operate the litter lights is from the No. 1 and No. 2 dc primary buses through circuit breakers on the mission readiness circuit breaker panel, marked **NO. 1 LTR LTS** and **NO. 2 LTR LTS**. The lights are operated from a split bus to provide one light at each litter in case of a single dc primary bus failure.

4.25.3 Litter Support Installation. The upper litter supports are supported by a center pivot shaft and two end pivot shafts, one at each end of the support (Figure 4-29). To tilt the upper end of the support only for loading or unloading of litter patients, the center shaft remains locked to the pedestal and the end shafts are disengaged for support pivoting. This system was designed to pivot about the center shaft. Although the supports may be pivoted at either end, more effort is required when the loaded litter is installed. To install the litter supports, do this:

a. Lower Litter Support Installation.

(1) Before installation, each center pivot shaft must be retracted and unlocked. The center pivot shaft handle must be secured in the handle retainer. End pivot handles must be in disengaged position.

(2) Engage T-bars on litter support with split retention fittings at bottom of pedestal.

(3) Line up end pivot shafts with holes. Disengage pivot shaft lever locks and move end pivot shaft lever toward pedestal, until pivot shaft is fully inserted into pivot shaft hole on pedestal and handle lock is engaged.

(4) Repeat step (3) for other end of litter support.

b. Upper Litter Support Installation.

(1) Prepare support. Before installation, each center pivot pin must be unlocked and retracted, and the handle disengaged from its retainer. End pivot handles must be in disengaged position.

(2) Tilt outer edge of litter support slightly down and engage T-bars into split retention fittings at second support hole from top of pedestal.

(3) Raise outer edge of litter support until support is level.

(4) Insert end pivot shaft into pedestal by pulling on pivot shaft lever lock, and moving lever toward pedestal until end pivot shaft engages partway in end pivot support hole.

(5) Position center pivot shaft lock handle counterclockwise to horizontal.

(6) Push center pivot shaft toward pedestal until shaft is fully inserted into center pivot shaft hole. Opposite end of litter support should be raised or lowered to help line up center shaft on support with center hole on pedestal.

(7) Turn center pivot lock lever clockwise to horizontal.

(8) Repeat step (4) for other end of litter support. Now slide both end pivot shafts in fully by moving pivot lever lock handle to engage position.

c. Litter Support Installation for Ambulatory Patient Seating.

(1) Prepare support as in b(1) above.

(2) Engage T-bar on litter pan with split retention brackets below support tilt stop brackets.

(3) Position litter support at second from bottom litter support end pivot hole on pedestal.

(4) Line up end pivot shafts with holes. Disengage pivot shaft lever lock and move pivot shaft lever toward

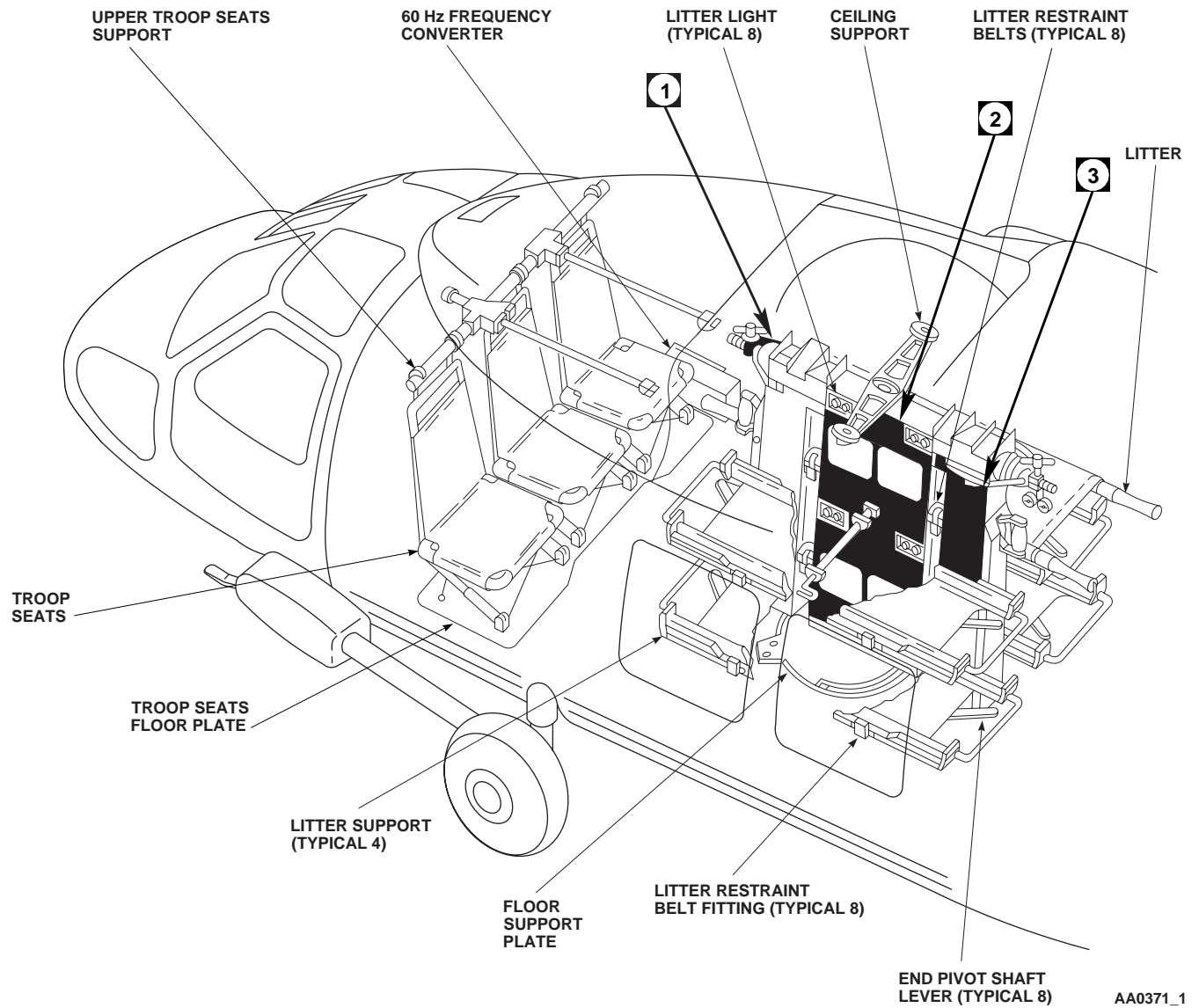

AA0371_1
SA

Figure 4-29. Medevac and Seat System (Sheet 1 of 5)

pedestal, until pivot shaft is fully inserted into pivot shaft hole on pedestal and handle lock is engaged.

(5) Repeat step (3) for other end of litter support.

4.25.4 Litter Support Removal. Removal of the litter support is the reverse of installation. Before removal, any litters on the support should be removed and belts unlocked. If IV or oxygen is installed, make certain hoses are not tangled with supports, then proceed as required.

4.25.5 Medevac Seats Installation. The seat installation consists of three of the troop seats that were removed for medevac system installation. Install required number of seats at station 271.0.

4.25.6 Litter Loading and Unloading. Litters can be loaded and unloaded laterally, directly onto the litter supports, from either side of the helicopter. Whenever rescue hoist and medevac kit are installed simultaneously, the upper, right litter support should be removed from the aircraft. The lower, right support may be stowed if not actually in use. The lower right litter support shall be installed in the lowest position and used when transporting more than two litter patients or when conducting hoist operations with a stokes litter. Loading of a stokes litter patient may be facilitated by rotating the litter pedestal approximately 30 degrees from the fly position. When returning the pedestal to the fly position the aft right corner of the litter support must be lifted to prevent interference with the lower hoist mount

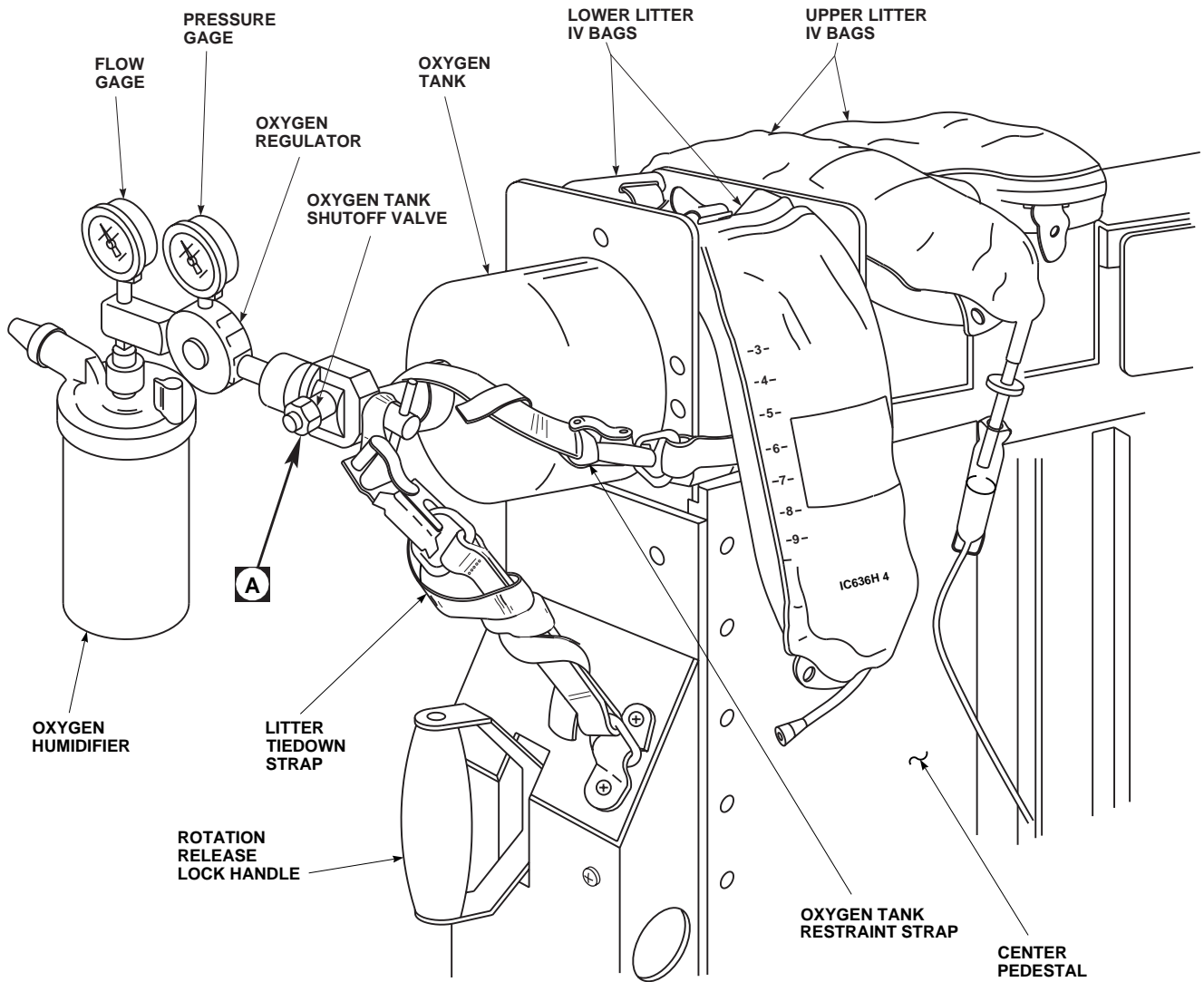

TYPICAL IV/OXYGEN TANK INSTALLATION
(SAME AS OTHER END OF PEDESTAL)

1

A

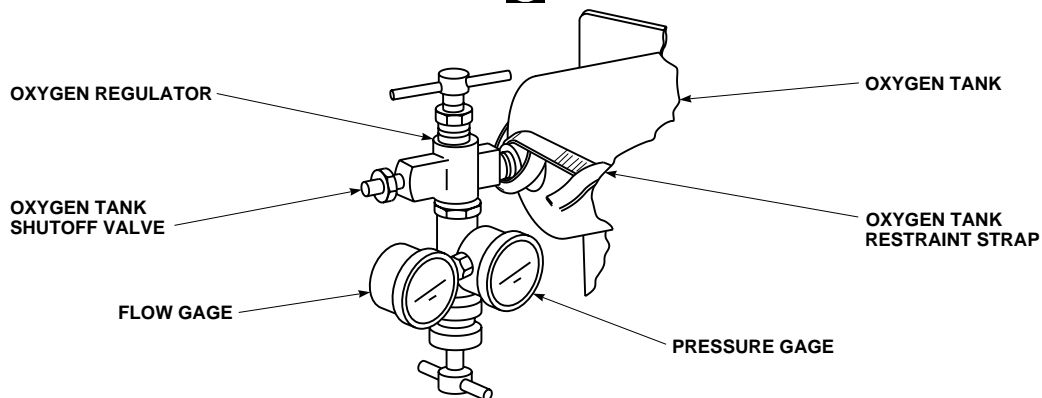

ALTERNATE OXYGEN REGULATOR INSTALLATION

AA0371_2
SA

Figure 4-29. Medevac and Seat System (Sheet 2 of 5)

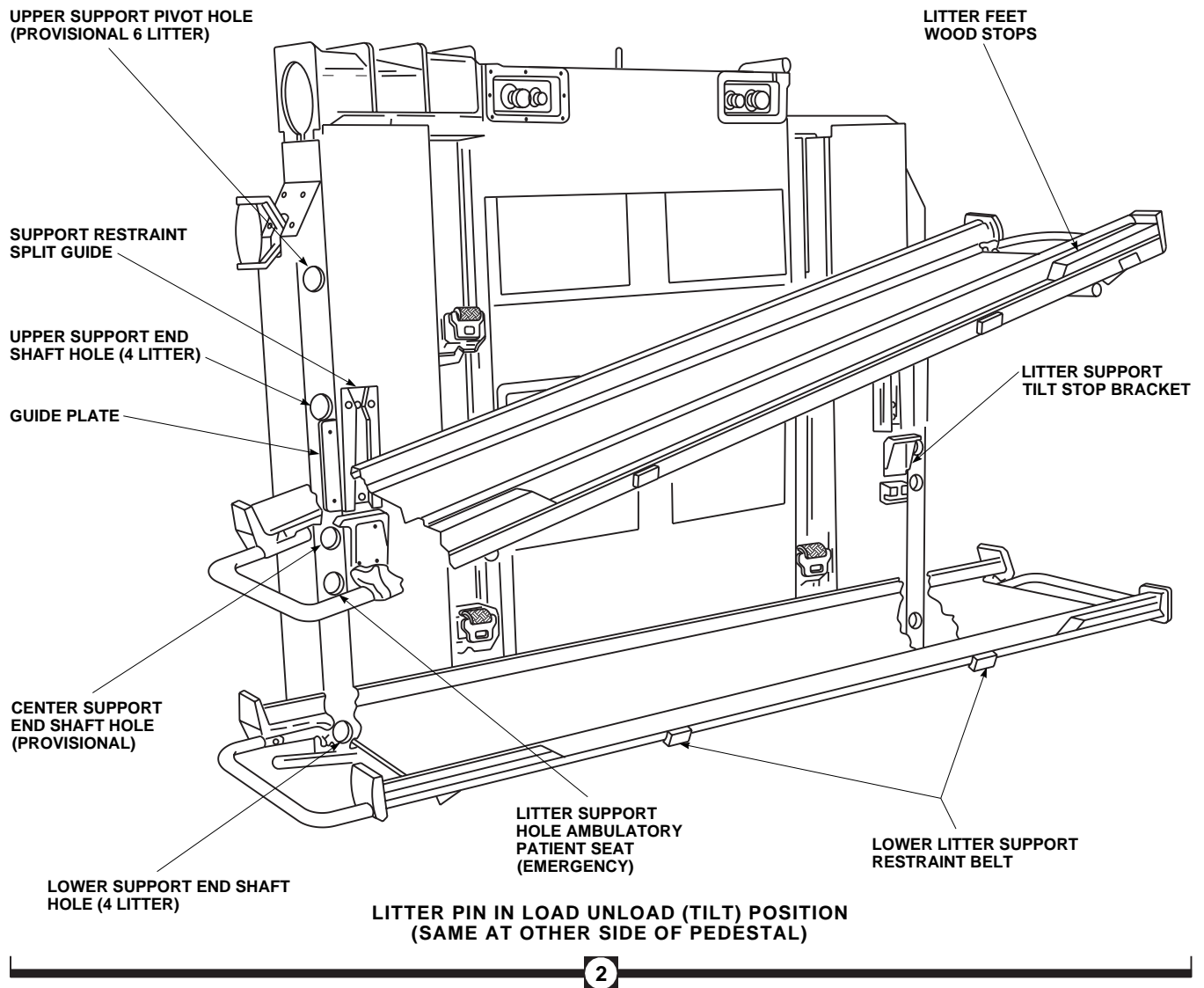

AA0371_3
SA

Figure 4-29. Medevac and Seat System (Sheet 3 of 5)

bracket. To load and unload litter patients, assuming the medevac kit is in the flight position (litters along longitudinal axis), do this:

1. Both cabin doors - Open.
2. Pedestal rotation lock release handle - Pull handle and turn pedestal clockwise 90° (viewed from above). On helicopters with extended external range fuel tanks installed, the pedestal will rotate only 60° from center line for loading litter patients.
3. Release lock handle while turning pedestal. Pedestal will automatically lock in a lateral position for loading and unloading.
4. Release both litter support end pivot shaft on upper litters. Disengage pivot lever locks and move levers away from pedestal. Hold support with opposite hand. Release lever. End pivot shafts should rest on fitting at hole. Litter support is now ready to be loaded from either side. Select side desired. Move end pivot release lever about 1 inch more to compress the shaft

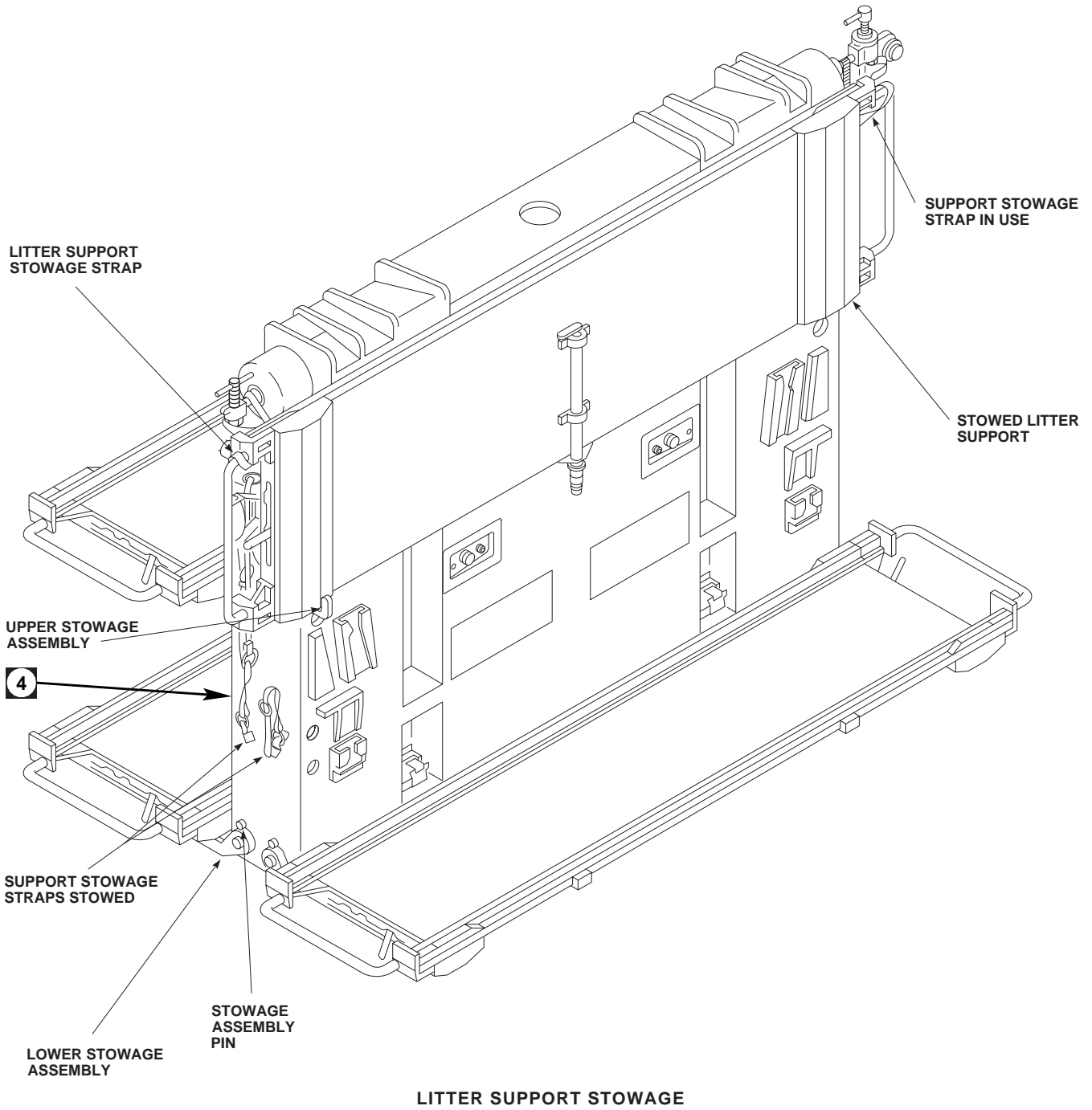
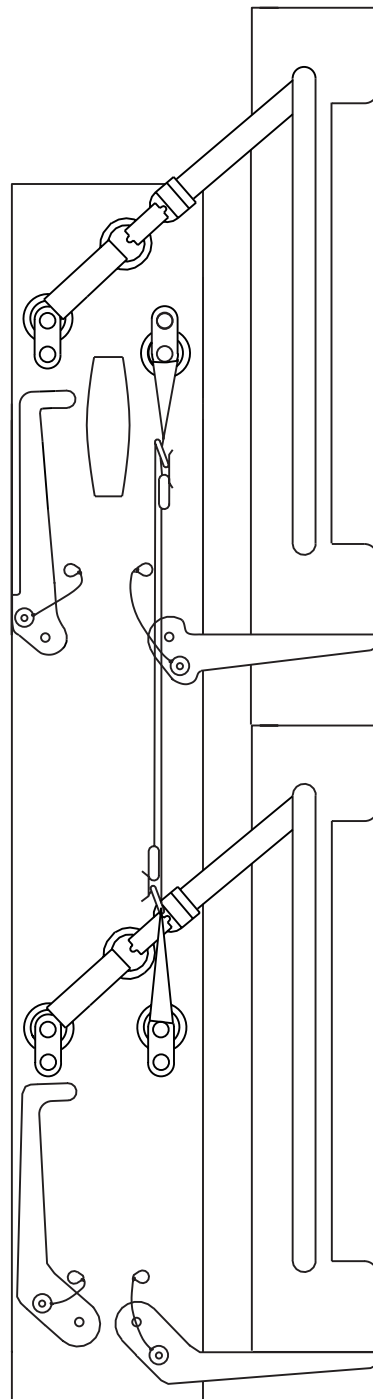

Figure 4-29. Medevac and Seat System (Sheet 4 of 5)



LEFT SIDE SHOWN
STOWAGE ASSEMBLY STOWED

RIGHT SIDE SHOWN
LITTER SUPPORTS STOWED
WITH CROSS STRAPS

Figure 4-29. Medevac and Seat System (Sheet 5 of 5)

springs, which allows the shaft to clear the end guide and the litter support to be lowered at the end. During the lowering, release pivot shaft lever to allow pivot shaft spring to push shaft onto lower stop fitting.

5. Using two persons (one each side or end) -Place litter with patient on end of upper support and push litter into position. Note that litter feet must be trapped between wood stops on litter support. If three or more patients are to be loaded, the upper supports must be loaded first. The reverse applies to unloading.
6. To tilt upper litter support end, pull shaft lever lock and move lever away from pedestal at support end which is being raised. Pivot litter support to level position until pivot shaft holes are lined up with pivot shafts. Move levers toward pedestal until shaft is fully inserted into shaft holes and handle locks are engaged.
7. Lower litters - Using two persons (one each side or end) place litter with patient on end of support and push litter into position. Note that litter feet must be trapped between wood stops on litter support.
8. Litter straps - Extend straps (on pedestal) and engage in buckle on litter supports. Pull straps out uniformly to engage; partial pulling will require complete retraction of the belt to disengage belt lock.
9. Pedestal rotation lock handle - Pull and turn pedestal counterclockwise 90° (viewed from above) into flight position (longitudinal axis), and release handle.
10. Cabin doors - Close.
11. Unloading is reverse of loading after litter straps are removed and oxygen and IV tubes are checked to make certain tangling will not occur with litter or support.

4.25.7 IV Bags and Oxygen Tanks Installation.



The pilot must be advised when oxygen is on board, its use must be per the Surgeon

General’s directives, and must have oxygen regulators attached.

Provisions for IV bags and oxygen tanks are on the top of the pedestal at each end. Four IV bags may be attached to each IV/oxygen assembly (Figure 4-29). IV bag hooks at the outer end of the assembly are used for the lower litters and the inner hooks are used for the upper litters. Eyelets at the top of the bag are placed on the IV hooks and the bags are hung downward. To prevent damage to IV bags, check clearance between transmission drip pan drain tube clamps and installed IV bags. Flow adjustment and replacement will be done by the medical attendant. Oxygen tanks are inserted into the assembly, bottom first. A restraint strap is provided to prevent the tank from falling out during normal maneuvering during flight. The strap is placed across the regulator in a manner and routed as shown in Figure 4-29, to prevent the restraint strap from slipping. The strap ends are attached and drawn tight to keep the tank secure.

4.25.8 Litter Support Stowage.



Storage of the litter support in the upper level stowed position can be dangerous during a crash sequence due to the release of the litter support from the carousel. Advise storage in this manner be avoided. Maintain this litter support in the installed position or place in the back of the carousel in the ambulatory level if there are no occupants along the aft bulkhead (Row 5).

The litter supports may be stowed along the center pedestal on each side, one above the other (Figure 4-29). Stowage brackets at each end of the pedestal provide lower support of the supports, and prevent the supports from moving away from the pedestal. Web straps attached to rings are used to hold the upper ends of the supports to the pedestal. Pins are used to hold the stowage brackets in a stowed position against the pedestal end. Two brackets are provided for each litter support. The top support must be stowed first, then the lower support. For reinstallation the sequence is reversed.

1. Lower the stowage support arm to the horizontal position and insert the support arm stowage pin through the support arm and into the center pedestal.

NOTE

Improper positioning of the support arm stowage pin reduces the holding capability of the support arm, which may cause the support arm to shear its pivot bolt during a hard landing or aircraft mishap.

2. Place the litter pan in the stowed position, with the top of the litter pan against the center pedestal and the pivot support arm properly stowed.
3. Secure the litter pan to the center pedestal by routing the opposite side web strap around the upper portion of the litter pan handle. Secure the metal clasp to the metal ring and tighten the web strap. (Use of the opposite side web strap will reduce excess movement of the litter pan while stowed).
4. If only one upper litter pan is to be stowed, as in step 3, additional security may be added by routing the same side web strap around the lower portion of the litter pan handle and fastening the web strap.



Do not store equipment between the stowed litter pan and the center pedestal.

5. The lower litter pan will be stowed in the same manner as in steps 1 through 3. The same side web strap may be used to secure the lower portion of the litter pan as in step 4 if only one lower litter is to be stowed.
6. Removal of stowed litter pans is accomplished in the reverse order of steps 1 through 4.

4.26 APU INLET PARTICLE SEPARATOR (IPS) KIT (HELICOPTERS WITH IPS KIT INSTALLED).

The APU IPS Kit provides APU inlet air filtration via a centrifugal particle separator unit. The separator is attached to the APU radial inlet housing and provides for collection and overboard exhausting of scavenge particles. The passive separator operation employs APU bleed air to drive an ejector pump used for particle scavenging. The IPS kit is designed to be physically compatible with both HIRSS and

non-HIRSS helicopters with the T-62T-40-1 series 200/300 APU installations only. The kit consists of three categories of removable components:

- a. Air particle separator assembly.
- b. APU modification kit - Parts required to modify the APU to accept the separator assembly.
- c. Airframe provisions - Parts required to install the separator assembly and provide bleed air supply and scavenge exhaust provisions.

4.27 SNOW SKIS.

Landing gear skis are constructed of fiberglass-reinforced plastic, and attached to the landing gear axle. The skis have spring cylinders and check cables to retain the ski in a 5° nose up attitude during flight.



Installation of skis requires removal of landing gear wire cutters and severely degrades the aircraft wire strike capability. Upon removal of skis, wire strike hardware shall be reinstalled, restoring aircraft to standard configuration prior to next flight.

Cockpit entry/exit paths are partially restricted by the main skis making cockpit entry/exit slightly more difficult. Additionally, the cabin entry/exit doors are partially restricted making the loading/unloading of cargo slightly more difficult.

NOTE

The hinged main gear ski shall only be used on the right landing gear of helicopters equipped with rescue hoists. The hinged ski is equipped with a retraction cable. This cable may be removed if it interferes with the hoist, or other equipment, and alternative retraction methods, such as a gaff, may be used.

CHAPTER 5

OPERATING LIMITS AND RESTRICTIONS

Section I GENERAL

5.1 PURPOSE.

This chapter identifies or refers to all important operating limits and restrictions that shall be observed during ground and flight operations.

5.2 GENERAL.

The operating limitations set forth in this chapter are the direct results of design analysis, tests, and operating experiences. Compliance with these limits will allow the pilot to safely perform the assigned missions and to derive maximum use from the aircraft.

NOTE

EH See current Interim Statement of Airworthiness Qualification for operating limits and restrictions for EH-60A helicopters.

See current Interim Statement of Airworthiness Qualification for operating limits and

restrictions for UH-60L helicopters 96-26723 and subsequent.

5.3 EXCEEDING OPERATIONAL LIMITS.

Any time an operational limit is exceeded an appropriate entry shall be made on DA Form 2408-13-1. Entry shall state what limit or limits were exceeded, range, time beyond limits, and any additional data that would aid maintenance personnel in the maintenance action that may be required. The helicopter shall not be flown until corrective action is taken.

5.4 MINIMUM CREW REQUIREMENTS.

The minimum crew required to fly the helicopter is two pilots. Additional crewmembers as required will be added at the discretion of the commander, in accordance with pertinent Department of the Army regulations.

Section II SYSTEM LIMITS

5.5 INSTRUMENT MARKING COLOR CODES.

NOTE

Instrument/color markings may differ from actual limits.

Operating limitations are shown as side arrows or colored strips on the instrument face plate of engine, flight and utility system instruments (Figures 5-1, 5-2, and 5-3). Those readings are shown by ascending and descending columns of multicolor lights (red, yellow and green) measured against vertical scales. RED markings indicate the limit above or below which continued operation is likely to cause damage or shorten component life. GREEN markings indicate the safe or normal range of operation. YELLOW markings indicate the range when special attention should be given to the operation covered by the instrument.

5.6 ROTOR LIMITATIONS.

It is not abnormal to observe a % **RPM 1** and **2** speed split during autorotational descent when the engines are fully decoupled from the main rotor. A speed increase of one engine from 100% reference to 103% maximum can be expected. During power recovery, it is normal for the engine operating above 100% RPM to lead the other engine. Refer to Figure 5-1 for limitations.

5.6.1 Rotor Start and Stop Limits. Maximum wind velocity for rotor start or stop is 45 knots from any direction.

5.6.2 Rotor Speed Limitations. Refer to Figure 5-1 for rotor limitations. Power off (autorotation) rotor speeds

up to **120% RPM R** are authorized for use by maintenance test flight pilots during autorotational RPM checks.

5.7 MAIN TRANSMISSION MODULE LIMITATIONS.

a. Oil pressure should remain steady during steady state forward flight or in level hover. Momentary fluctuations in oil pressure may occur during transient maneuvers (i.e. hovering in gusty wind conditions), or when flying with pitch attitudes above +6°. These types of oil pressure fluctuations are acceptable, even when oil pressure drops into the yellow range (below 30 psi). Oil pressure should remain steady and should be in the 45 to 55 psi range for the UH-60A/EH-60A, and 45 to 60 psi range for the UH-60L, to ensure that when fluctuations occur they remain in the acceptable range as defined above. If oil pressure is not steady during steady state forward flight or in a level hover, or if oil pressure is steady but under 45 psi, make an entry on Form 2408-13-1. Sudden pressure drop (more than 10 PSI) without fluctuation requires an entry on Form 2408-13-1.

b. A demand for maximum power from engines with different engine torque factors (ETF) will cause a torque split when the low ETF engine reaches TGT limiting. This torque split is normal. Under these circumstances, the high power engine may exceed the dual engine limit. (Example: #1 TRQ = 96% at TGT limiting, #2 TRQ is allowed to go up to 104%. Total aircraft torque = $(96\%+104\%)/2 = 100\%$).

c. With transmission oil temperature operation in the precautionary range, an entry should be made on DA Form 2408-13-1 except when hovering in adverse conditions described in Chapter 8 Desert and Hot Weather Operations.

MAIN ROTOR OVERSPEED

- *  127%
- **  137%
- ***  142%

ENGINE % RPM 1-2

12-SECOND TRANSIENT	105% - 107%
TRANSIENT	101% - 105%
CONTINUOUS	95% - 101%
MINIMUM EXCEPT FOR IDLE AND TRANSIENT	91%

AVOID OPERATIONS IN 20% - 40% AND 60% - 90% RANGE EXCEPT DURING START AND SHUTDOWN

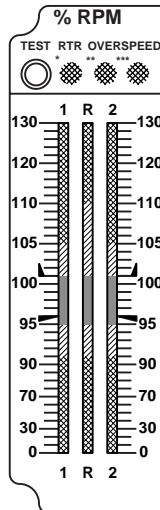

MAIN ROTOR % RPM R

POWER ON

TRANSIENT	101% - 107%
CONTINUOUS	95% - 101%
MINIMUM EXCEPT FOR IDLE AND TRANSIENT	91%

POWER OFF (AUTOROTATION)

MAXIMUM	110%
TRANSIENT	105% - 110%
NORMAL	90% - 105%

FUEL QUANTITY UH60A EH

NORMAL	200 - 1500 LBS
PRECAUTIONARY	0 - 200 LBS

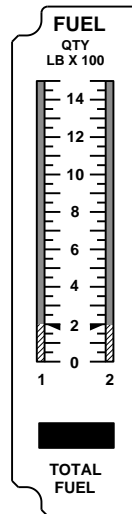

FUEL QUANTITY UH-60L

NORMAL	200 - 1500 LBS
PRECAUTIONARY	0 - 200 LBS

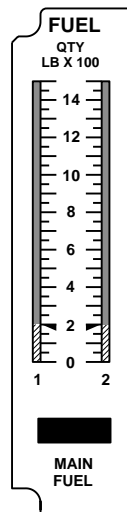





LEGEND	
	RED
	YELLOW
	GREEN
	DIGITAL READOUT

Figure 5-1. Instrument Markings (Sheet 1 of 2)



AIRSPEED

MAXIMUM 193 KNOTS

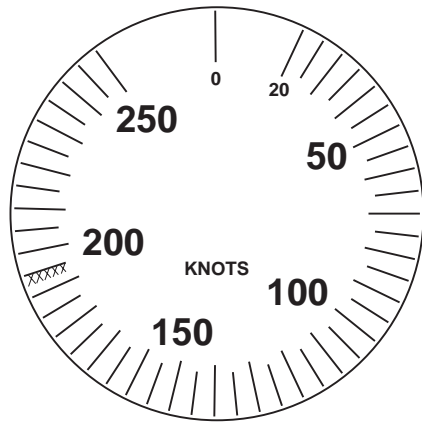
**REFER TO SECTION V FOR
ADDITIONAL AIRSPEED
LIMITATIONS**

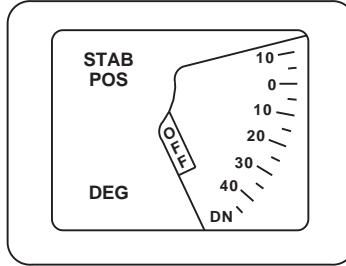

S T A B	D E G	KIAS LIMIT
	0°	150
	10°	100
	20°	80
	30°	60
	40°	45

AA8670_2A
SA

Figure 5-1. Instrument Markings (Sheet 2 of 2)

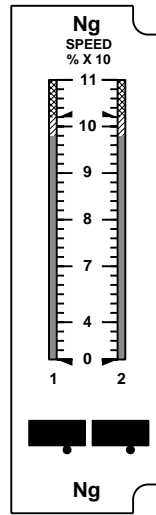

ENGINE Ng	
10-SECOND TRANSIENT	102% - 105%
30-MINUTE LIMIT	99% - 102%
CONTINUOUS	0 - 99%

ENGINE OIL TEMPERATURE	
MAXIMUM	150 °C
30-MINUTE LIMIT	135 - 150°C
CONTINUOUS	-50 - 135°C

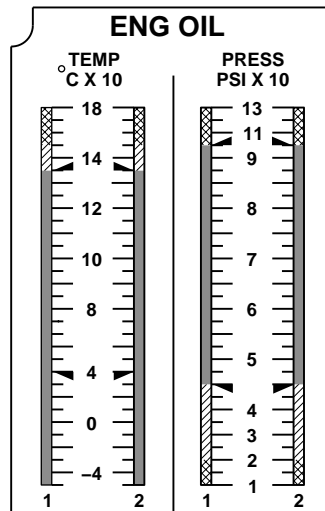

ENGINE OIL PRESSURE	
MAXIMUM	100 PSI
CONTINUOUS	20 - 100 PSI*

* 35 PSI MINIMUM AT 90% Ng AND ABOVE

LEGEND	
	RED
	YELLOW
	GREEN
	DIGITAL READOUT

AA8671_1
SA

Figure 5-2. Instrument Markings (Sheet 1 of 2) 700

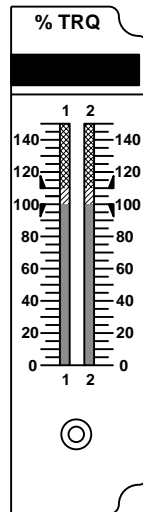

ENGINE % TRQ

700

10-SECOND TRANSIENT	DUAL-ENGINE	100% - 125%
	SINGLE-ENGINE	110% - 135%
CONTINUOUS SINGLE-ENGINE ONLY		0% - 110%
CONTINUOUS DUAL-ENGINE		0% - 100%

TURBINE GAS TEMPERATURE

700

10-SECOND TRANSIENT	850 - 886°C
START ABORT LIMIT	850°C
30-MINUTE LIMIT	775 - 850°C
NORMAL	0 - 775°C

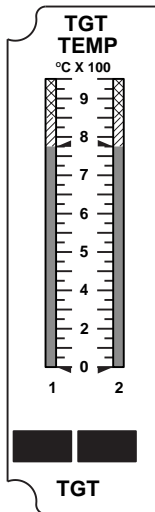

MAIN TRANSMISSION OIL TEMPERATURE

UH60A EH

MAXIMUM	120°C
PRECAUTIONARY	105 - 120°C
CONTINUOUS	-50 - 105°C

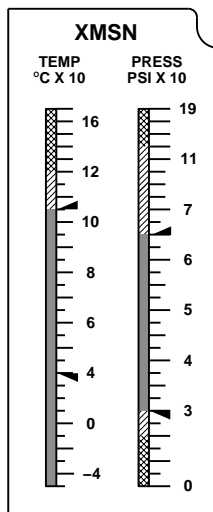

MAIN TRANSMISSION OIL PRESSURE

MAXIMUM	130 PSI
PRECAUTIONARY	65 - 130 PSI
CONTINUOUS	30 - 65 PSI
IDLE AND TRANSIENT	20 - 30 PSI
MINIMUM	20 PSI

AA8671_2B
SA

Figure 5-2. Instrument Markings (Sheet 2 of 2)

NOTE

HELICOPTERS PRIOR TO S / N 91-26354 THAT ARE NOT EQUIPPED WITH IMPROVED MAIN ROTOR FLIGHT CONTROLS ARE FURTHER RESTRICTED ABOVE 80 KIAS TO DUAL-ENGINE CONTINUOUS TORQUE LIMITS AS INDICATED BY A PLACARD ON THE INSTRUMENT PANEL. SEE FIGURE 5-4.

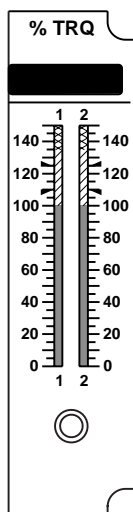

ENGINE % TRQ

10-SECOND TRANSIENT

DUAL-ENGINE
 ABOVE 80 KIAS 100% - 144%
 80 KIAS OR BELOW 120% - 144%

SINGLE-ENGINE 135% - 144%

MAXIMUM CONTINUOUS

SINGLE-ENGINE 0% - 135%

DUAL-ENGINE
 ABOVE 80 KIAS 0% - 100%
 AT OR BELOW 80 KIAS 0% - 120%

TURBINE GAS TEMPERATURE

10-SECOND TRANSIENT	903 - 949°C
2.5-MINUTES TRANSIENT (CONTINGENCY POWER)	878 - 903°C
START ABORT LIMIT	851°C
10-MINUTE LIMIT	851 - 878°C
30-MINUTE LIMIT	810 - 851°C
NORMAL	0 - 810°C

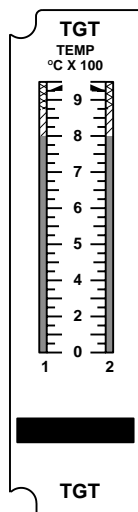

LEGEND	
	RED
	YELLOW
	GREEN
	DIGITAL READOUT

AA8672_1A
SA

Figure 5-3. Instrument Markings (Sheet 1 of 2) 701C

ENGINE OIL TEMPERATURE

MAXIMUM	150°C
30-MINUTE LIMIT	135 – 150°C
CONTINUOUS	-50 – 135°C

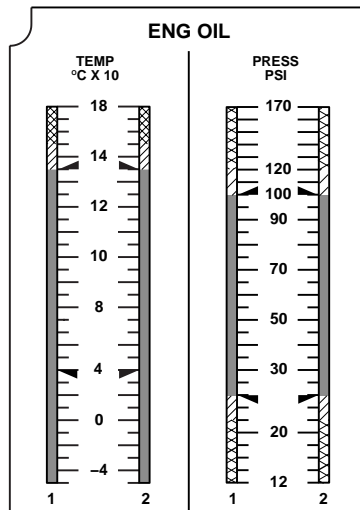

ENGINE OIL PRESSURE

701C

MAXIMUM	120 PSI
5-MINUTE LIMIT	100 – 120 PSI
NORMAL OPERATION	26 – 100 PSI
IDLE	22 – 26 PSI
MINIMUM	22 PSI

MAIN TRANSMISSION OIL TEMPERATURE

UH60L

MAXIMUM	140°C
PRECAUTIONARY	105 – 140°C
CONTINUOUS	-50 – 105°C

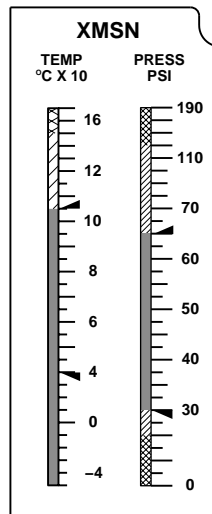

MAIN TRANSMISSION OIL PRESSURE

MAXIMUM	130 PSI
PRECAUTIONARY	65 – 130 PSI
CONTINUOUS	30 – 65 PSI
IDLE AND TRANSIENT	20 – 30 PSI
MINIMUM	20 PSI

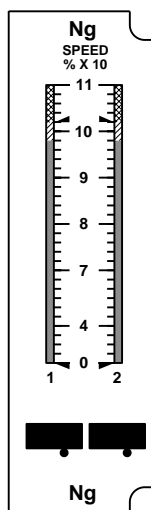

ENGINE Ng

10-SECOND TRANSIENT	102% – 105%
30-MINUTE LIMIT	99% – 102%
CONTINUOUS	0 – 99%

AA8672_2B
SA

Figure 5-3. Instrument Markings (Sheet 2 of 2)

Section III POWER LIMITS

5.8 ENGINE LIMITATIONS.

5.8.1 Engine Power Limitations. **700** The limitations which are presented in Figure 5-2, present absolute limitations, regardless of atmospheric conditions. For variations in power available with temperature and pressure altitude, refer to the TORQUE AVAILABLE charts in Chapter 7.

5.8.2 Engine Power Limitations.

701C

a. The limitations which are presented in Figure 5-3, present absolute limitations regardless of atmospheric conditions. For variations in power available with temperature and pressure altitude, refer to TORQUE AVAILABLE charts in Chapter 7A.

b. Helicopters prior to S/N 91-26354 that are not equipped with improved main rotor flight controls are further restricted above 80 KIAS to dual-engine continuous torque limits as indicated by a placard on the instrument panel. See Figure 5-4.

5.8.3 Engine % RPM Limitations. Transient % RPM 1 or 2 operation in yellow range (101% to 105%) is not recommended as good operating practice. However no damage to either engine or drive train is incurred by operation within this range. Momentary transients above 107% Np are authorized for use by maintenance test pilots during autorotational rpm checks.

5.8.4 Engine Starter Limits.

a. The pneumatic starter is capable of making the number of consecutive start cycles listed below, when exposed to the environmental conditions specified, with an interval of at least 60 seconds between the completion of one cycle and the beginning of the next cycle. A starting cycle is the interval from start initiation and acceleration of the compressor, from zero rpm, to starter dropout. The 60-second delay between start attempts applies when the first attempt is aborted for any reason, and it applies regardless of the duration of the first attempt. If motoring is required for an emergency, the 60-second delay does not apply.

b. At ambient temperatures of 15°C (59°F) and below, two consecutive start cycles may be made, followed by a 3-minute rest period, followed by two additional consecu-

tive start cycles. A 30-minute rest period is then required before any additional starts.

c. At ambient temperatures above 15° up to 52°C (59° up to 126°F), two consecutive start cycles may be made. A 30-minute rest period is then required before any additional start cycles.

5.9 PNEUMATIC SOURCE INLET LIMITS.

The minimum ground-air source (pneumatic) required to start the helicopter engines is 40 psig and 30 ppm at 149°C (300°F). The maximum ground-air source to be applied to the helicopter is 50 psig at 249°C (480°F), measured at the external air connector on the fuselage.

5.10 ENGINE START LIMITS.



Engine start attempts at or above a pressure altitude of 18,000 feet **701C, or 20,000 feet **700** could result in a Hot Start.**

Crossbleed starts shall not be attempted unless the anti-ice light is off, and operating engine must be at 90% Ng **SPEED** or above and rotor speed at 100% **RPM R**. When attempting single-engine starts at pressure altitudes above 14,000 feet, press the start switch with the **ENG POWER CONT** lever **OFF**, until the maximum motoring speed (about 24%) is reached, before going to **IDLE**. Engine starts using APU source may be attempted when within the range of FAT and pressure altitude of Figure 5-5.

5.11 ENGINE OVERSPEED CHECK LIMITATIONS.

Engine overspeed check in flight is prohibited. Engine overspeed checks, on the ground, are authorized by designated maintenance personnel only.

5.12 FUEL LIMITATIONS.

When using all fuel types, both fuel boost pumps shall be on and operational, otherwise engine flameout may result.

UH-60L DUAL-ENGINE TORQUE LIMITS - % TORQUE										
FAT, ° C	-20	-10	0	10	20	30	40	50	FAT, ° C	
PRESSURE ALT 1000 FT	20	60	58	56	53	51	49	48	46	20
	18	66	63	61	59	56	54	52	50	18
	16	72	69	66	64	61	59	57	55	16
	14	79	75	73	70	67	65	62	60	14
	12	86	82	79	76	73	70	68	66	12
	10	93	89	85	83	80	77	74	71	10
	8		97	93	90	86	83	81	77	8
	6				97	93	90	87	83	6
	5		100			97	93	90	87	5
	4						97	94	91	4
3	100% TORQUE 2000 FT & BELOW							97	95	3
FAT, ° C	-20	-10	0	10	20	30	40	50	FAT, ° C	

HELICOPTERS PRIOR TO S / N 91-26354 NOT EQUIPPED WITH IMPROVED MAIN ROTOR FLIGHT CONTROLS.

AA1641A
SA

Figure 5-4. Dual-Engine Torque Limitations at Airspeeds Above 80 KIAS **701C**

Section IV LOADING LIMITS

5.13 CENTER OF GRAVITY LIMITATIONS.

Center of gravity limits for the aircraft to which this manual applies and instructions for computation of the center of gravity are contained in Chapter 6.

5.14 WEIGHT LIMITATIONS.

AIRCRAFT	MAXIMUM WEIGHT
UH-60A	20,250
EH-60A	20,250
UH-60A (see paragraph 1)	22,000
EH-60A (see paragraph 1)	22,000
UH-60L	22,000
UH-60A/L with seven lug wheels (see paragraph 5)	20,500
UH-60L External lift mission (see paragraph 3)	23,500
ESSS aircraft on ferry mission (see paragraph 2)	24,500

1. UH-60A and EH-60A maximum gross weight can be extended from 20,250 pounds to 22,000 pounds only when wedge mounted pitot-static probes and either/or MWO 55-1520-237-50-58 or MWO 1-1520-237-50-73 are installed.

2. Airworthiness release required.

3. External lift missions above 22,000 pounds can only be flown with cargo hook loads above 8,000 pounds and up to 9,000 pounds.

4. Maximum weight is further limited by cargo floor maximum capacity of 300 pounds per square foot. Refer to Chapter 6.

5. When operating at or above gross weights of 20,500 pounds, the seven lug wheel may experience lug failure resulting in flying debris during ground handling and/or unexpected tire failure. The fourteen lug wheel shall be utilized when operating at or above gross weights of 20,500 pounds.

5.15 STOWAGE PROVISIONS.

Maximum capacity for each storage compartment is 125 pounds.

5.16 CABIN CEILING TIEDOWN FITTINGS.

The four cabin ceiling tiedown fittings have a limited load capability of 4,000 pounds.

5.17 CARGO HOOK WEIGHT LIMITATION.

For UH-60A aircraft, the maximum weight that may be suspended from the cargo hook is limited to 8,000 pounds. For UH-60L aircraft, the maximum weight that can be suspended from the cargo hook is 9,000 pounds.

NOTE

UH-60L aircraft prior to serial number 92-26421, will require an entry into DA Form 2408-13-1 following the first mission carrying an external cargo hook load exceeding 8,000 pounds.

5.18 RESCUE HOIST WEIGHT LIMITATIONS.

The maximum weight that may be suspended from the rescue hoist is 600 pounds.

Section V AIRSPEED LIMITS

5.19 AIRSPEED OPERATING LIMITS.

The airspeed operating limits charts (Figures 5-6, 5-7 and 5-8) define velocity never exceed (Vne) as a function of altitude, temperature, and gross weight. The dashed lines represent the Mach limited airspeeds due to compressibility effects. Additional airspeed limits not shown on the charts are:

a. Maximum airspeed with external cargo hook loads greater than 8,000 pounds and a corresponding gross weight greater than 22,000 pounds will vary due to the external load physical configuration, but shall not exceed 120 KIAS.

b. Maximum airspeed for one engine inoperative is 130 KIAS.

c. Maximum airspeed for autorotation at a gross weight of 16,825 pounds or less is 150 KIAS.

d. Maximum airspeed for autorotation at a gross weight of greater than 16,825 pounds is 130 KIAS.

e. Sideward/rearward flight limits. Hovering in winds greater than 45 knots (35 knots with external ERFs) from the sides or rear is prohibited. Sideward/rearward flight into the wind, when combined with windspeed, shall not exceed 45 knots (35 knots with external ERFs).

f. SAS inoperative airspeed limits:

(1) One SAS inoperative - 170 KIAS.

(2) Two SAS inoperative - 150 KIAS.

(3) Two SAS inoperative in IMC - 140 KIAS.

g. Hydraulic system inoperative limits:

(1) One hydraulic system inoperative - 170 KIAS.

(2) Two hydraulic systems inoperative - 150 KIAS.

(3) Two hydraulic systems inoperative in IMC - 140 KIAS.

h. Searchlight and landing light airspeed limits.

(1) Landing light. If use is required, the landing light must be extended prior to reaching a maximum forward

airspeed of 130 KIAS. With landing light extended, airspeed is limited to 180 KIAS.

(2) Searchlight. If use is required, the searchlight must be extended prior to reaching a maximum forward airspeed of 100 KIAS. With searchlight extended, airspeed is limited to 180 KIAS.

i. **VOL** The maximum airspeed for autorotation shall be limited to 100 KIAS.

j. Maximum airspeed with skis installed is 155 KIAS. **I**

5.20 FLIGHT WITH CABIN DOOR(S)/WINDOW(S) OPEN.

The following airspeed limitations are for operating the helicopter in forward flight with the cabin doors/window open:

a. Cabin doors.

(1) Cabin doors may be fully open up to 100 KIAS with soundproofing installed aft of station 379.

(2) Cabin doors may be fully open up to 145 KIAS with soundproofing removed aft of station 379 or with soundproofing secured properly.

(3) The doors will not be intentionally moved from the fully open or closed position in flight. The cabin doors may be opened or closed during hovering flight. The cabin doors must be closed or fully opened and latched before forward flight. Should the door inadvertently open in flight, it may be secured fully open or closed.

b. Gunner's window(s) may be fully open up to 170 KIAS.

c. Cockpit doors sliding windows will not be opened or closed during flight except during hover.

d. Flight with cockpit door(s) removed is prohibited.

e. **VOL** Flight with cabin door(s) open is not authorized.

5.21 AIRSPEED LIMITATIONS FOLLOWING FAILURE OF THE AUTOMATIC STABILATOR CONTROL SYSTEM.

a. Manual control available. If the automatic stabilator control system fails in flight and operation cannot be restored:

AIRSPEED OPERATING LIMITATIONS

AIRCRAFT WITHOUT ESSS INSTALLED 100% RPM R

EXAMPLE

WANTED

MAX IAS FOR VARIOUS
TEMPS, PRESSURE
ALTITUDE AND
GROSS WEIGHTS

KNOWN

FAT = -20°C
PRESSURE ALTITUDE
= 4,000 FEET.
GROSS WEIGHT
= 18,000 POUNDS.

METHOD

ENTER FAT AT -20°C.
MOVE RIGHT TO
PRESSURE ALTITUDE
4,000 FEET.
MOVE DOWN TO
18,000 POUNDS
GROSS WEIGHT
OR MACH LIMIT
WHICHEVER IS
ENCOUNTERED
FIRST. IN THIS
CASE 18,000
POUNDS IS
ENCOUNTERED
FIRST. MOVE LEFT
TO READ 186
KNOTS.

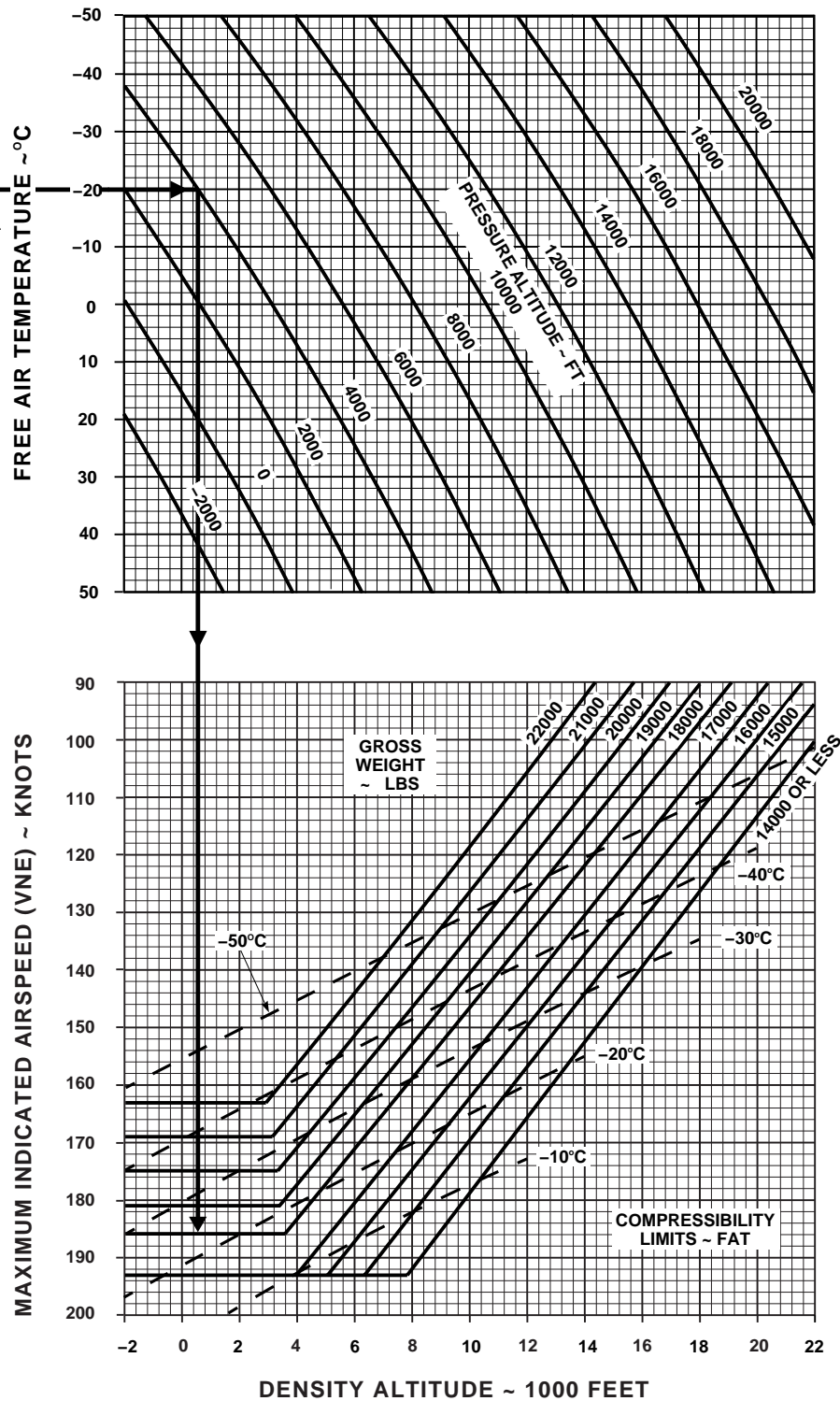

AA1250A
SA

Figure 5-6. Airspeed Operating Limits

AIRSPEED OPERATING LIMITATIONS

AIRCRAFT WITH EXTERNAL STORES SUPPORT SYSTEM INSTALLED

100% RPM R

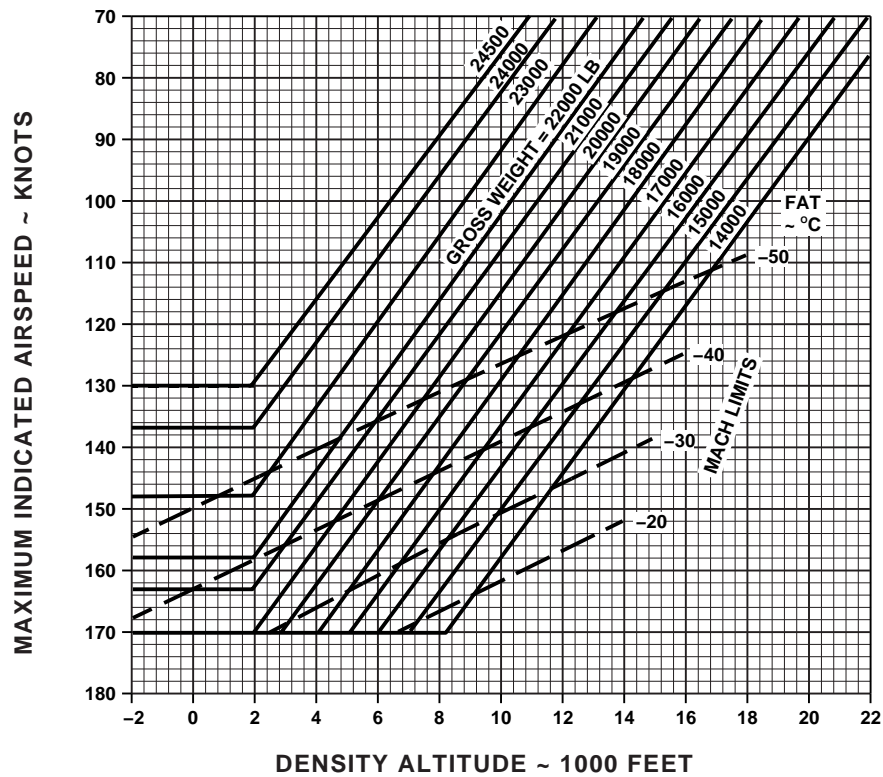
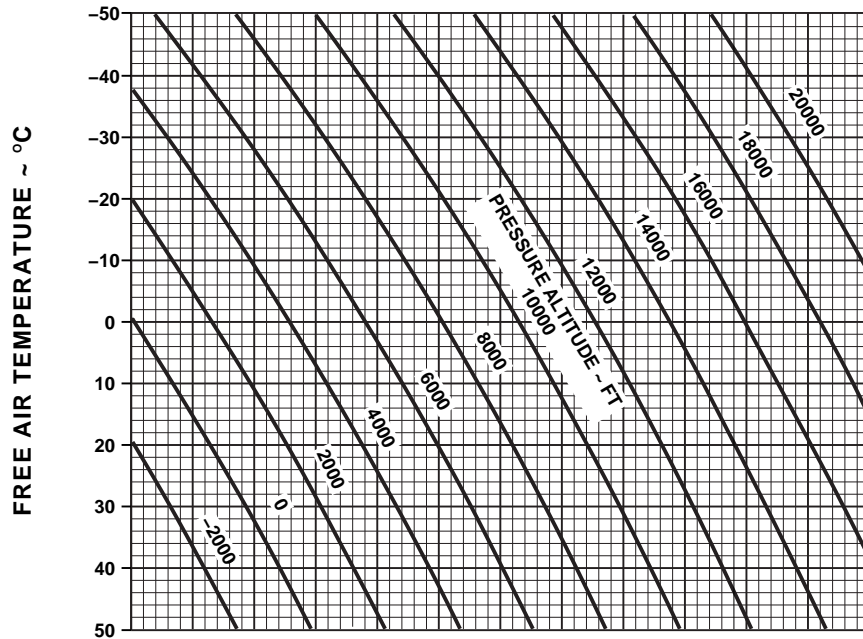

AA1251B
SA

Figure 5-7. Airspeed Operating Limits **ES**

AIRSPEED OPERATING LIMITATIONS

VOLCANO MINE DESPENSING SYSTEM WITH CANISTERS 100% RPM R

AIRSPEED
OPERATING
LIMITS
VOLCANO

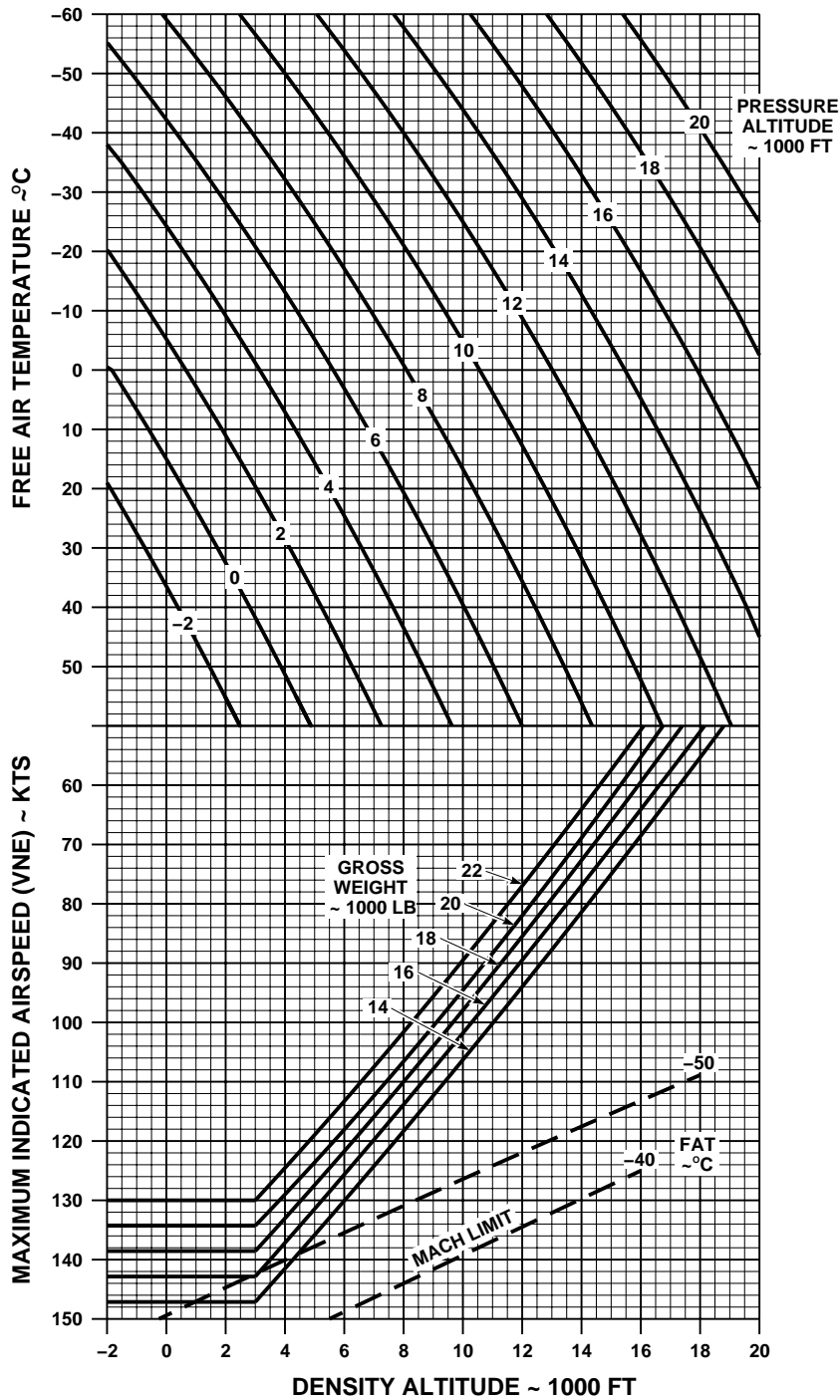

AA9440
SA

Figure 5-8. Airspeed Operating Limits **VOL** (Sheet 1 of 2)

AIRSPEED OPERATING LIMITATIONS

VOLCANO MINE DESPENSING SYSTEM WITHOUT CANISTERS 100% RPM R

AIRSPEED
OPERATING
LIMITS
VOLCANO

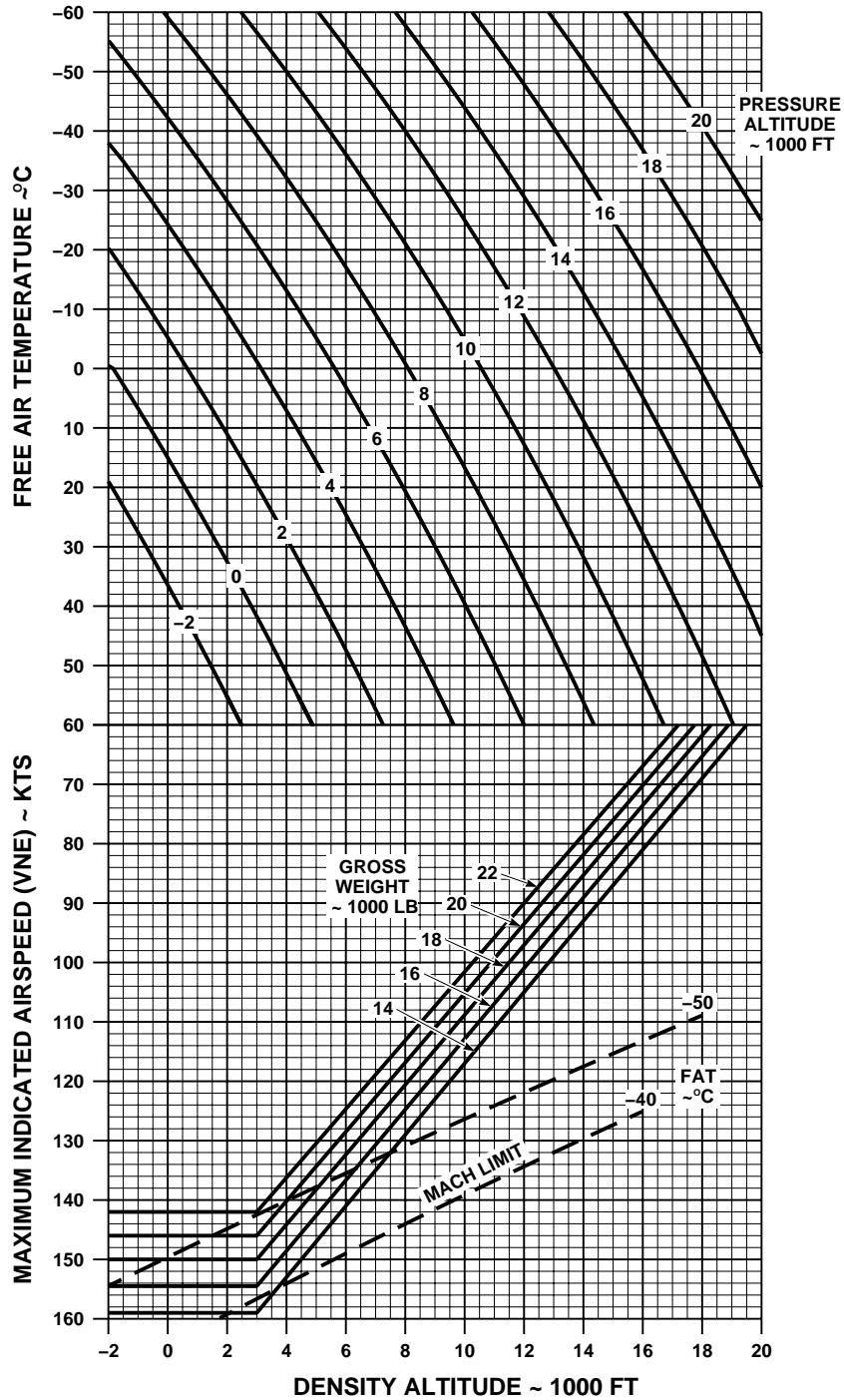

AA9441
SA

Figure 5-8. Airspeed Operating Limits **VOL** (Sheet 2 of 2)

(1) The stabilator shall be set full down at speeds below 40 KIAS.

(2) The stabilator shall be set at zero degrees at speeds above 40 KIAS.

(3) Autorotation airspeed shall be limited to 120 KIAS at all gross weights.

b. Manual control not available. The placard airspeed limits shall be observed as not-to-exceed speed (powered flight and autorotation), except in no case shall the autorotation limit exceed 120 KIAS.

Section VI MANEUVERING LIMITS

5.22 PROHIBITED MANEUVERS.

- a. Hovering turns greater than 30° per second are prohibited. Intentional maneuvers beyond attitudes of $\pm 30^\circ$ in pitch or over 60° in roll are prohibited.
- b. Simultaneous moving of both **ENG POWER CONT** levers to **IDLE** or **OFF** (throttle chop) in flight is prohibited.
- c. Rearward ground taxi is prohibited.

5.23 RESTRICTED MANEUVERS.

5.23.1 Manual Operation of the Stabilator. Manual operation of the stabilator in flight is prohibited except as required by formal training and maintenance test flight requirements, or as alternate stabilator control in case the **AUTO** mode malfunctions.

5.23.2 Downwind Hovering. Prolonged rearward flight and downwind hovering are to be avoided to prevent accumulation of exhaust fumes in the helicopter and heat damage to windows on open cargo doors.

5.23.3 Maneuvering Limitations.

NOTE

Maneuvers entered from a low power setting may result in transient droop of 5% **RPM R** or greater.

a. The maneuvering limits of the helicopter, other than as limited by other paragraphs within this section, are always defined by main rotor blade stall. Stall has not been encountered in one G flight up to the airspeeds shown in chart Figure 5-6 for aircraft without ESSS installed and Figure 5-7 for aircraft with ESSS installed.

b. The blade stall chart (Figure 5-9) while not an aircraft limitation, provides the level flight angle of bank at which blade stall will begin to occur as a function of airspeed, gross weight, pressure altitude and temperature. When operating near blade stall, any increase in airspeed, load factor (bank angle), turbulence, or abrupt control inputs will increase the severity of the stall. Fully developed stall will be accompanied by heavy four per rev vibration, increasing torque, and loss of altitude. Recovery is always accomplished by reducing the severity of the maneuver, that is by reducing collective, reducing airspeed, and/or re-

ducing the angle of bank. Maneuvering flight which results in severe blade stall and significant increase in 4 per rev vibration is prohibited.

5.23.3.1 High Speed Yaw Maneuver Limitation.

Above 80 KIAS avoid abrupt, full pedal inputs to prevent excess tail rotor system loading.

5.23.3.2 Limitations for Maneuvering With Sling Loads.

Maneuvering limitations with a sling load is limited to a maximum of 30° angle of bank in forward flight (Figure 5-10). Side flight is limited by bank angle and is decreased as airspeed increases. Rearward flight with sling load is limited to 35 knots.

5.23.3.3 Limitations for Maneuvering With Rescue Hoist Loads.

Maneuvering limitations with a rescue hoist load is limited to maximum of 30° angle of bank in forward flight (Figure 5-10). Side flight is limited by bank angle and is decreased as airspeed is increased. Rearward flight with hoist load is limited to 35 knots. Rate of descent is limited to 1,000 feet-per-minute.

5.23.3.4 Bank Angle Limitation. Bank angles shall be limited to 30° when a **PRI SERVO PRESS** caution light is on.

5.24 LANDING GEAR LIMITATIONS.

Do not exceed a touchdown sink rate of 540 feet-per-minute on level terrain and 360 feet-per-minute on slopes with gross weights of up to 16,825 pounds; above 16,825 pounds gross weight 300 feet-per-minute on level terrain and 180 feet-per-minute on slopes.

5.25 LANDING SPEED LIMITATIONS.

Maximum forward touchdown speed is limited to 60 knots ground speed on level terrain.

5.26 SLOPE LANDING LIMITATIONS.

The following slope limitations apply regardless of gross weight or CG, with or without ESSS/ERFS.

CAUTION

When performing slope landings with External Extended Range Fuel System Tanks, ensure tank to ground clearance.

AIRSPEED FOR ONSET OF BLADE STALL LEVEL FLIGHT 100% RPM R

EXAMPLE

WANTED

MAX RECOMMENDED
AIRSPEED FOR KNOWN
ANGLE OF BANK

KNOWN

FAT = 20 °C
PRESSURE ALTITUDE
= 5,000 FEET.
GROSS WEIGHT
= 23,000 POUNDS
ANGLE OF BANK
= 20 DEGREES

METHOD

ENTER PRESSURE ALTITUDE
AT 5,000 FEET. MOVE
RIGHT TO 20 DEGREES FAT.
MOVE DOWN TO GROSS
WEIGHT 23,000 POUNDS. MOVE
LEFT TO 20 DEGREE ANGLE
OF BANK. MOVE VERTICALLY
DOWN TO READ INDICATED
AIRSPEED OF 108 KNOTS.

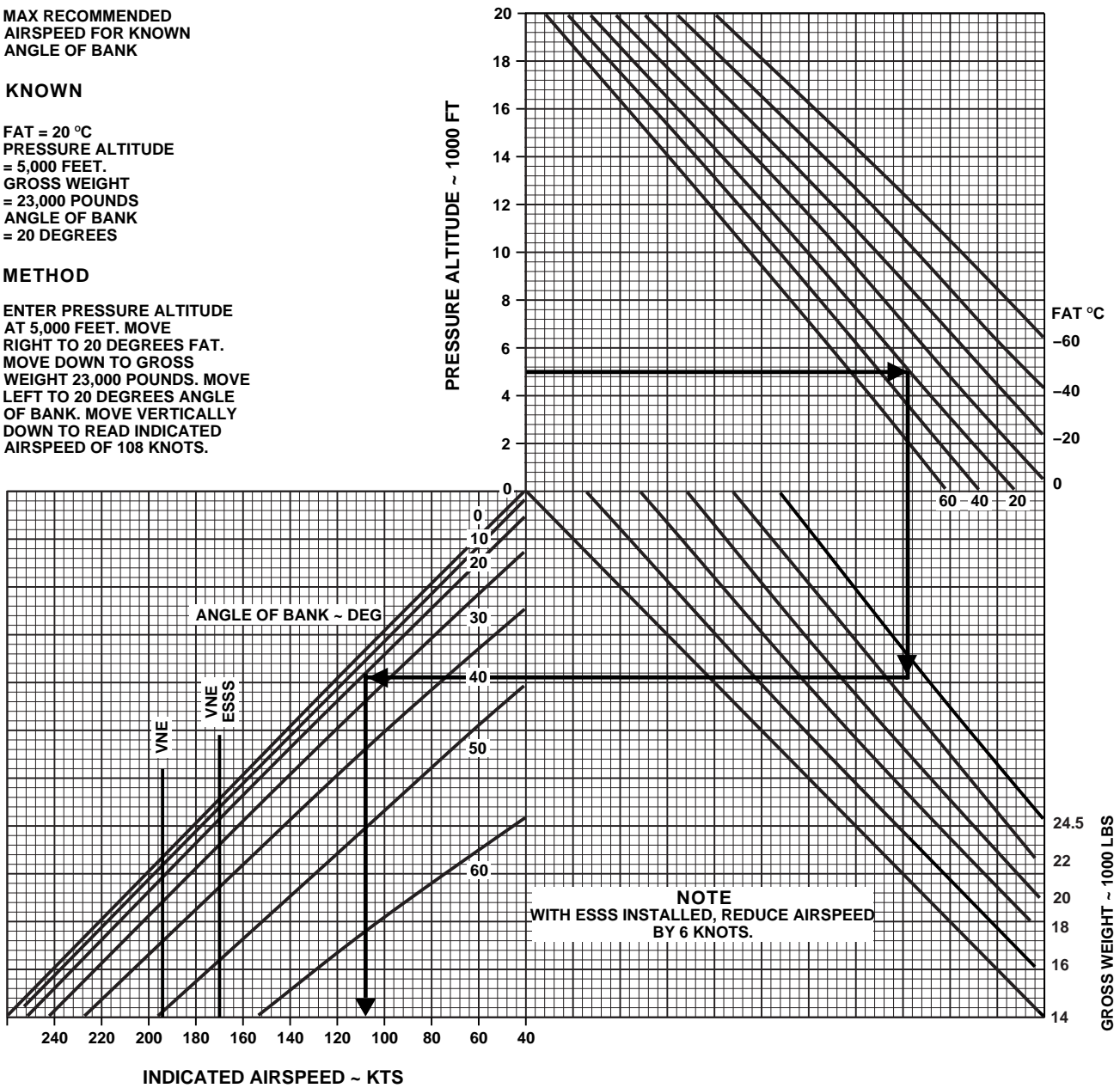

NOTE
WITH ESSS INSTALLED, REDUCE AIRSPEED
BY 6 KNOTS.

AA1306A
SA

Figure 5-9. Airspeed for Onset of Blade Stall

NOTE

Because of the flat profile of the main transmission and forward location of both transmission oil pumps, transmission oil pressure will drop during nose-up slope operations. At slope angle of 10° an indicated oil pressure of 30 to 35 psi is normal, and at a 15° slope angle a pressure in the range of 10 to 15 psi is normal, due to pitching of the helicopter.

- a. 15° nose-up, right wheel up or left wheel upslope. The slope limitations shall be further reduced by 2° for every 5 knots of wind.
- b. 6° nose downslope. Landing in downslope conditions with tail winds greater than 15 knots shall not be

conducted. A low-frequency oscillation may occur when landing nose-down on a slope with the cyclic near the aft stop.

- c. The main gearbox may be operated up to 30 minutes at a time with pressure fluctuations when the helicopter is known to be at a nose-up attitude (i.e., slope landings or hover with extreme aft CG).

- d. When attempting a nose upslope landing at gross weights in excess of 16,000 pounds with skis installed, the parking brake may not hold the aircraft in position. The pilot should be prepared to use the toe brakes.

- e. Slope landings with skis installed are limited to 10° nose up and right wheel or left wheel upslope.

SLING/RESCUE HOIST LOAD MANEUVERING LIMITS

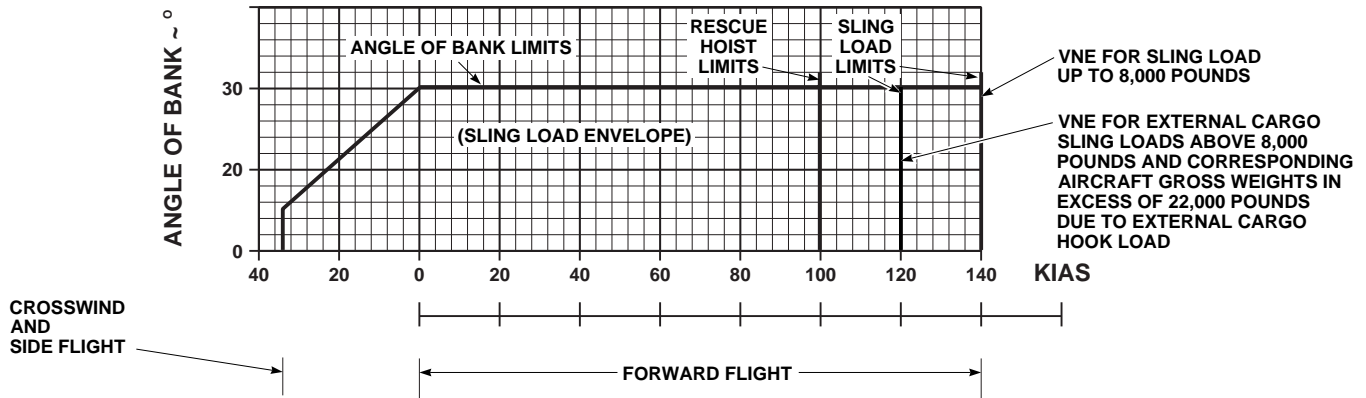

AA0668A
SA

Figure 5-10. Sling/Hoist Load Maneuvering Limitations

Section VII ENVIRONMENTAL RESTRICTIONS

5.27 FLIGHT IN INSTRUMENT METEOROLOGICAL CONDITIONS (IMC).

This aircraft is qualified for operation in instrument meteorological conditions.

5.28 FLIGHT IN ICING CONDITIONS.

a. When the ambient air temperature is 4°C (39°F) or below and visible liquid moisture is present, icing may occur. Icing severity is defined by the liquid water content (LWC) of the outside air and measured in grams per cubic meter (g/m³).

- | | |
|--------------|--|
| (1) Trace | :LWC 0 to 0.25 g/m ³ |
| (2) Light | :LWC 0.25 to 0.5 g/m ³ |
| (3) Moderate | :LWC 0.5 to 1.0 g/m ³ |
| (4) Heavy | :LWC greater than 1.0 g/m ³ |

b. Helicopters with the following equipment installed and operational are permitted to fly into trace or light icing conditions. Flight into light icing is not recommended without the blade deice kit. Flight into moderate icing shall comply with paragraph 5.28 c.

- (1) Windshield Anti-ice.
- (2) Pitot Heat.
- (3) Engine Anti-ice.
- (4) Engine Inlet Anti-ice Modulating Valve.
- (5) Insulated Ambient Air Sensing Tube.

c. For flight into moderate icing conditions, all equipment in paragraph 5.28 b. and blade deice kit must be installed and operational. Flight into heavy or severe icing is prohibited.

d. Helicopters equipped with blade erosion kit are prohibited from flight into icing conditions.

5.29 ENGINE AND ENGINE INLET ANTI-ICE LIMITATIONS.

At engine power levels of 10% **TRQ** per engine and below, full anti-ice capability cannot be provided, due to engine bleed limitations. Avoid operation under conditions

of extreme low power requirements such as high rate of descent (1900 fpm or greater), or ground operation below 100% RPM R, during icing conditions. The cabin heating system should be turned off before initiating a high rate of descent.

5.30 BACKUP HYDRAULIC PUMP HOT WEATHER LIMITATIONS.

During prolonged ground operation of the backup pump using MIL-H-83282 or MIL-H-5606 with the rotor system static, the backup pump is limited to the following temperature/time/cooldown limits because of hydraulic fluid overheating.

FAT °C (°F)	Operating Time (Minutes)	Cooldown (Pump Off) (Minutes)
-54° - 32° (-65° - 90°)	Unlimited	- -
33° - 38° (91° - 100°)	24	72
39° - 52° (102° - 126°)	16	48

5.31 APU OPERATING LIMITATIONS.

To prevent APU overheating, APU operation at ambient temperature of 43°C (109°F) and above with engine and rotor operating, is limited to 30 minutes. With engine and rotor not operating, the APU may be operated continuously up to an ambient temperature of 51°C (124°F).

5.32 WINDSHIELD ANTI-ICE LIMITATIONS.

Windshield anti-ice check shall not be done when FAT is over 27°C (80°F).

5.33 TURBULENCE AND THUNDERSTORM OPERATION.

- a. Intentional flight into severe turbulence is prohibited.
- b. Intentional flight into thunderstorms is prohibited.
- c. Intentional flight into turbulence with a sling load attached and an inoperative collective pitch control friction is prohibited.

Section VIII OTHER LIMITATIONS

5.34 EXTERNAL EXTENDED RANGE FUEL SYSTEM KIT CONFIGURATIONS. **ES**

NOTE

Flight with 450-gallon ERFS tanks is prohibited unless operating under an Airworthiness Release from U. S. Army Aviation and Missile Command.

The ERFS kit shall only be utilized in the following approved configurations:

- a. A 230-gallon tank installed on each inboard vertical stores pylon.
- b. A 230-gallon tank installed on each outboard vertical stores pylon.
- c. Four 230-gallon tanks installed, one on each inboard and each outboard vertical stores pylon.

5.35 JETTISON LIMITS.

- a. **ES** The jettisoning of fuel tanks in other than an emergency is prohibited.
- b. **ES** The recommended external fuel tank jettison envelope is shown in Table 5-1.

- c. **VOL** Jettisoning, if necessary, shall be accomplished at airspeeds not to exceed 110 KIAS and rates of descent not to exceed 500 fpm.

5.36 USE OF M60D GUN(S) WITH ERFS KIT INSTALLED. **ES**

Use of the M60D gun(s) is prohibited when external ERFS tanks are installed on the outboard vertical stores pylons, unless the external ERFS pintle mount stop is installed. Use of the M60D gun(s) is prohibited when external tanks are installed on the inboard vertical stores pylon.

5.37 GUST LOCK LIMITATIONS.



Before engine operations can be performed with the gust lock engaged, all main rotor tie downs shall be removed.

- a. Dual-engine operation with gust lock engaged is prohibited.
- b. Single-engine operation with gust lock engaged will be performed by authorized pilot(s) at **IDLE** only. Gust lock shall not be disengaged with engine running.

Table 5-1. Recommended Emergency External Fuel Tank Jettison Envelope

RECOMMENDED EMERGENCY JETTISON ENVELOPE							
LEVEL FLIGHT	AIRSPEED KIAS						
	0 TO 120				120 TO Vh		
	SLIP INDICATOR DISPLACED NO MORE THAN ONE BALL WIDTH LEFT OR RIGHT					NO SIDESLIP BALL CENTERED	
DESCENT	*JETTISON BELOW 80 KIAS NOT RECOMMENDED	AIRSPEED KIAS					*JETTISON ABOVE 120 KIAS NOT RECOMMENDED
		80	90	100	110	120	
		1000	875	750	625	500	
		MAX RATE OF DESCENT FT/MIN					

*Not recommended because safe jettison at these conditions has not been verified by tests.

5.38 MAINTENANCE OPERATIONAL CHECKS (MOC).

Whenever a MOC requires that engines be started, pilots performing the MOCs must be authorized by the commander, trained and qualified in accordance with aircrew training manual (ATM), (TM 55-1500-328-23), DA PAM 738-751, and local standard operating procedures (SOP). The MOCs must be performed with checks enumerated in the maintenance test flight manual (MTF) or the -23 series maintenance manuals.

5.39 USE OF AN/ARC-220() HF RADIO.

If installation of the AN/ARC-220() HF radio is not in accordance with MWO 1-1520-237-50-76, an airworthiness release from U. S. Army Aviation and Missile Command is required.

5.40 USE OF AN/ARN-128B DOPPLER/GPS RADIO.

a. The AN/ASN-128B shall not be used as the primary source of navigation information for Instrument Flight Rule (IFR) operations in controlled airspace.

b. Use of GPS landing mode of CIS is prohibited under IMC.

5.41 USE OF SKIS.

Water buckets shall not be used when skis are installed.

CHAPTER 6

WEIGHT/BALANCE AND LOADING

Section I GENERAL

6.1 INTRODUCTION.

This chapter contains instructions and data to compute any combination of weight and balance for this helicopter, if basic weight and moment are known.

6.2 CLASS.

Army helicopters defined in this manual are in Class 1 **EH** and Class 2 **UH**. Additional directives governing weight and balance of Class 1 and Class 2 aircraft forms and records are contained in AR 95 series, TM 55-1500-342-23, and DA PAM 738-751.

6.3 HELICOPTER COMPARTMENT AND STATION DIAGRAM.

Figure 6-1 shows the reference datum line that is 341.2 inches forward of the centroid of the main rotor, the fuselage stations, waterlines and buttlines. The fuselage is divided into compartments A through F. The equipment in each compartment is listed on DD Form 365-1 (Chart A) in the individual aircraft weight and balance file.

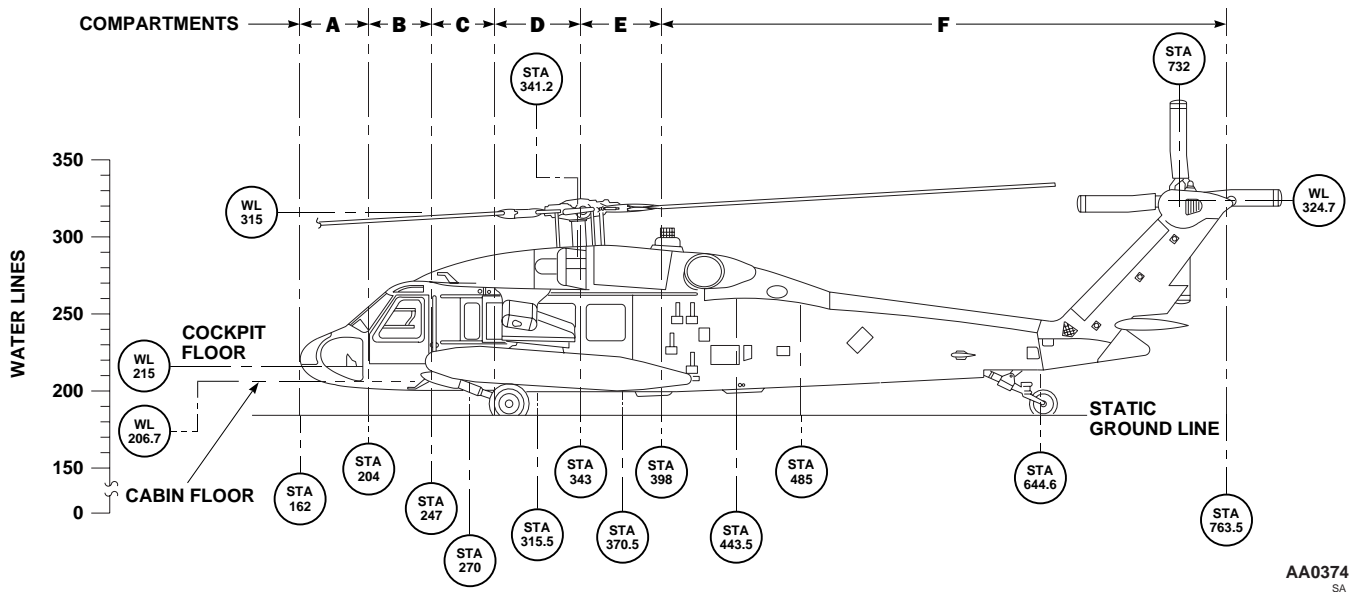
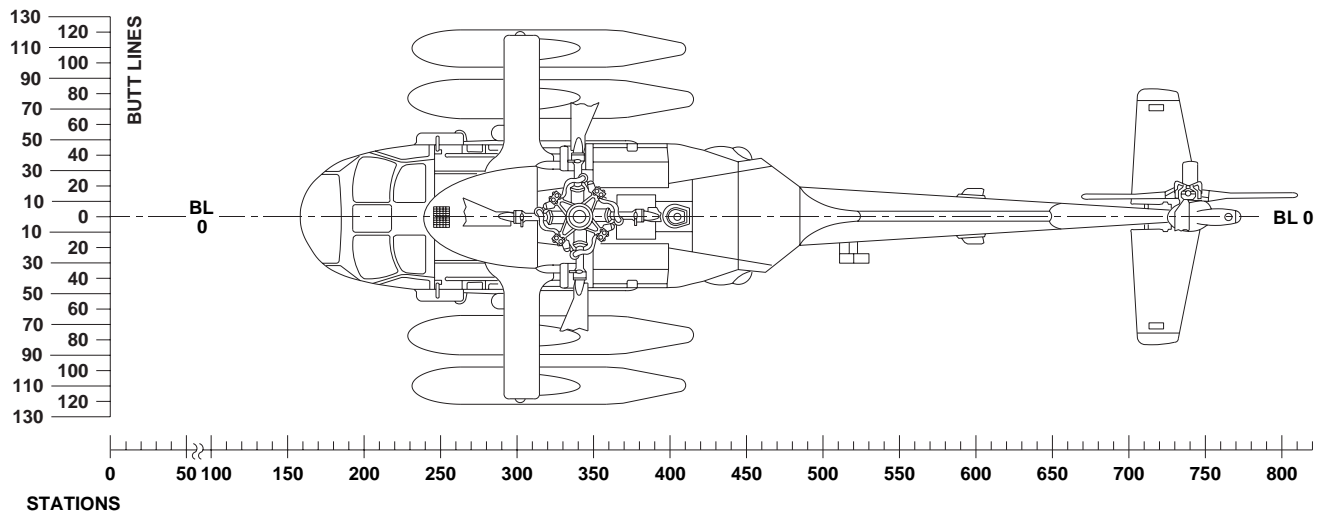

Figure 6-1. Helicopter Compartment and Station Diagram

Section II WEIGHT AND BALANCE

6.4 SCOPE.

This section provides appropriate information required for the computation of weight and balance for loading an individual helicopter. The forms currently in use are the DD Form 365 series. The crewmember has available the current basic weight and moment which is obtained from DD Form 365-3 (Chart C) for the individual helicopter. This chapter contains weight and balance definitions; explanation of, and figures showing weights and moments of variable load items.

6.5 WEIGHT DEFINITIONS.

a. **Basic Weight.** Basic weight of an aircraft is that weight which includes all hydraulic systems and oil systems full, trapped and unusable fuel, and all fixed equipment, to which it is only necessary to add the crew, fuel, cargo, and ammunition (if carried) to determine the gross weight for the aircraft. The basic weight varies with structural modifications and changes of fixed aircraft equipment.

b. **Operating Weight.** Operating weight includes the basic weight plus aircrew, the aircrew's baggage, and emergency and other equipment that may be required. Operating weight does not include the weight of fuel, ammunition, cargo, passengers or external auxiliary fuel tanks if such tanks are to be disposed of during flight.

c. **Gross Weight.** Gross weight is the total weight of an aircraft and its contents.

6.6 BALANCE DEFINITIONS.

6.6.1 Horizontal Reference Datum. The horizontal reference datum line is an imaginary vertical plane at or forward of the nose of the helicopter from which all horizontal distances are measured for balance purposes. Diagrams of each helicopter show this reference datum line as balance station zero.

6.6.2 Arm. Arm, for balance purposes, is the horizontal distance in inches from the reference datum line to the CG of the item. Arm may be determined from the helicopter diagram in Figure 6-1.

6.6.3 Moment. Moment is the weight of an item multiplied by its arm. Moment divided by a constant is generally used to simplify balance calculations by reducing the number of digits. For this helicopter, moment/1000 has been used.

6.6.4 Average Arm. Average arm is the arm obtained by adding the weights and moments of a number of items, and dividing the total moment by the total weight.

6.6.5 Basic Moment. Basic moment is the sum of the moments for all items making up the basic weight. When using data from an actual weighing of a helicopter, the basic moment is the total of the basic helicopter with respect to the reference datum. Basic moment used for computing DD Form 365-4 is the last entry on DD Form 365-3 for the specific helicopter. Cargo Hook Moments and Rescue Hoist Moments are shown in Figures 6-7 and 6-8, respectively.

6.6.6 Center of Gravity (CG). Center of gravity is the point about which a helicopter would balance if suspended. Its distance from the reference datum line is found by dividing the total moment by the gross weight of the helicopter.

6.6.7 CG Limits. CG limits (Figures 6-13 and 6-14) defines the permissible range for CG stations. The CG of the loaded helicopter must be within these limits at takeoff, in the air, and on landing.

6.7 DD FORM 365-3 (CHART C) WEIGHT AND BALANCE RECORDS.

DD Form 365-3 (Chart C) is a continuous history of the basic weight, moment, and balance, resulting from structural and equipment changes in service. At all times the last weight, moment/constant, is considered the current weight and balance status of the basic helicopter.

6.8 LOADING DATA.

The loading data in this chapter is intended to provide information necessary to work a loading problem for the helicopter. From the figures, weight and moment are obtained for all variable load items and are added arithmetically to the current basic weight and moment from DD Form 365-3 (Chart C) to obtain the gross weight and moment. If the helicopter is loaded within the forward and aft CG limits, the moment figure will fall numerically between the limiting moments. The effect on the CG of the expenditures in flight of such items as fuel and cargo may be checked by subtracting the weights and moments of such items from the takeoff gross weight and moment, and checking the new moment, with the CG limits chart. This check should be made to determine whether or not the CG will remain within limits during the entire flight.

6.9 DD FORM 365-4 (FORM F).

There are two versions of DD Form 365-4. Refer to TM 55-1500-342-23 for completing the form.

Section III FUEL/OIL

6.10 FUEL MOMENTS.



Fuel transfer sequence must be carefully planned and executed in order to maintain CG within limits.

When operating with a light cabin load or no load, it may be necessary to adjust fuel load to remain within aft CG limits. Fuel loading is likely to be more restricted on those aircraft with the HIRSS installed.

For a given weight of fuel there is only a very small variation in fuel moment with change in fuel specific weight. Fuel moments should be determined from the line on Figure 6-2 which represents the specific weight closest to that of the fuel being used. The full tank usable fuel weight will vary depending upon fuel specific weight. The aircraft fuel gage system was designed for use with JP-4,

but does tend to compensate for other fuels and provide acceptable readings. When possible the weight of fuel on-board should be determined by direct reference to the aircraft fuel gages. The following information is provided to show the general range of fuel specific weights to be expected. Specific weight of fuel will vary depending on fuel temperature. Specific weight will decrease as fuel temperature rises and increases as fuel temperature decreases at the rate of approximately 0.1 lb/gal for each 15°C change. Specific weight may also vary between lots of the same type fuel at the same temperature by as much as 0.5 lb/gal. The following approximate fuel weights at 15°C may be used for most mission planning:

Fuel Type	Specific Weight
JP-4	6.5 lb/gal.
JP-5	6.8 lb/gal.
JP-8	6.7 lb/gal.
Jet A	6.8 lb/gal.
Jet B	6.3 lb/gal.

FUEL MOMENTS

EXAMPLE

WANTED

FUEL MOMENT

KNOWN

FUEL QUANTITY
MAIN 1700 POUNDS

METHOD

FOR MAIN TANK ENTER
AT 1700 POUNDS AND
MOVE RIGHT TO MAIN LINE.
MOVE DOWN READ
MOMENT / 1000 = 710

ITEM	STA	WEIGHT LBS	MOM/1000
230-GALLON TANK (IB OR OB)	321	150	48
450-GALLON TANK (IB)	316	234	74

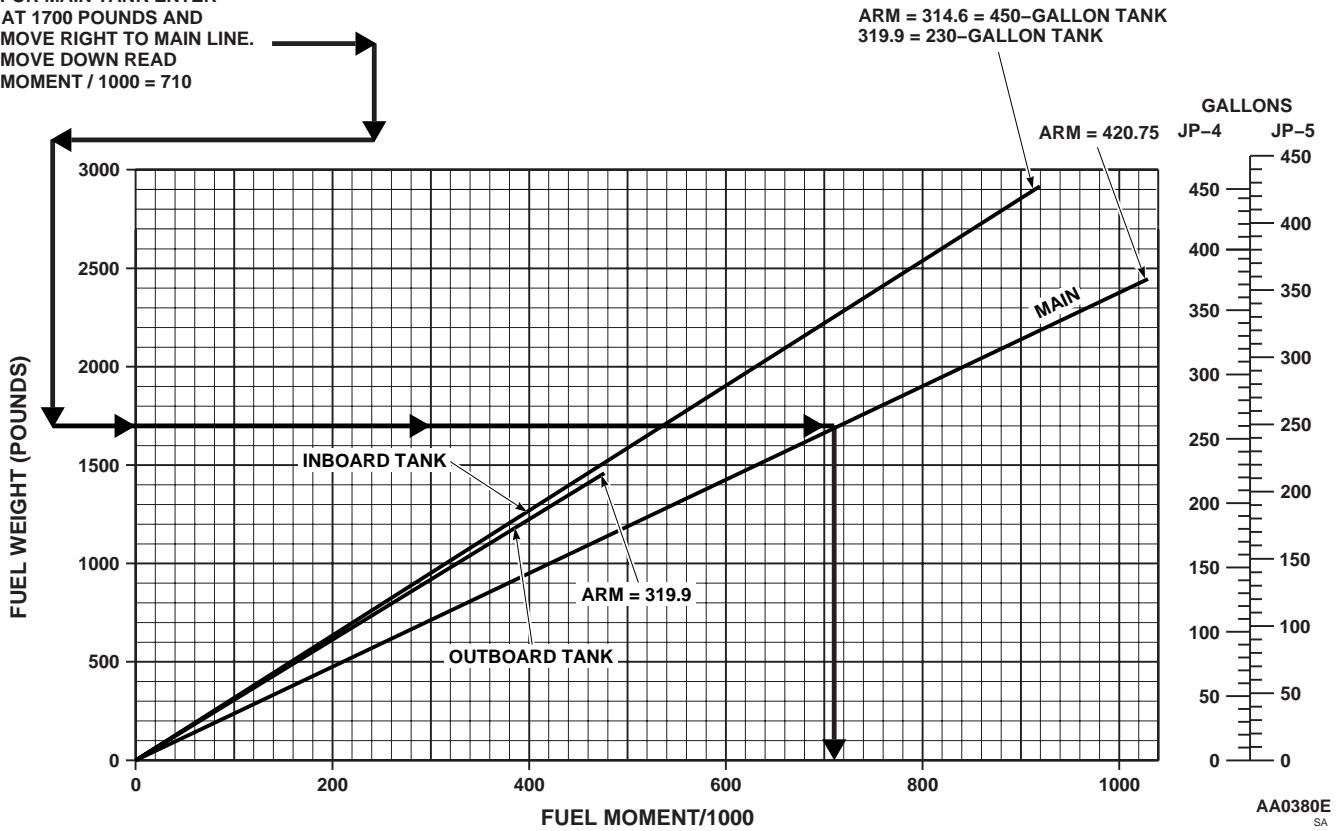

Figure 6-2. Fuel Moments

Section IV PERSONNEL

6.11 PERSONNEL MOMENTS.

When aircraft are operated at critical gross weights, the exact weight of each individual occupant plus equipment should be used. Personnel moments data is shown on Figure 6-3. If weighing facilities are not available, or if the tactical situation dictates otherwise, loads shall be computed as follows:

- a. Combat equipped soldiers: 240 pounds per individual.
- b. Combat equipped paratroopers: 260 pounds per individual.
- c. Crew and passengers with no equipment: compute weight according to each individual's estimate.

6.12 MEDEVAC KIT PERSONNEL MOMENTS.

- a. Litter moments are in Figure 6-4.
- b. Medevac system (excluding litters) weight and moments are included in the helicopter basic weight and moments Form 365-3 when installed.
- c. Litter weight is estimated to 25 pounds which includes litter, splints, and blankets.
- d. Medical attendant's average weight is 200 pounds.
- e. Medical equipment and supplies should be stored per unit loading plan and considered in weight and balance computations.

PERSONNEL MOMENTS

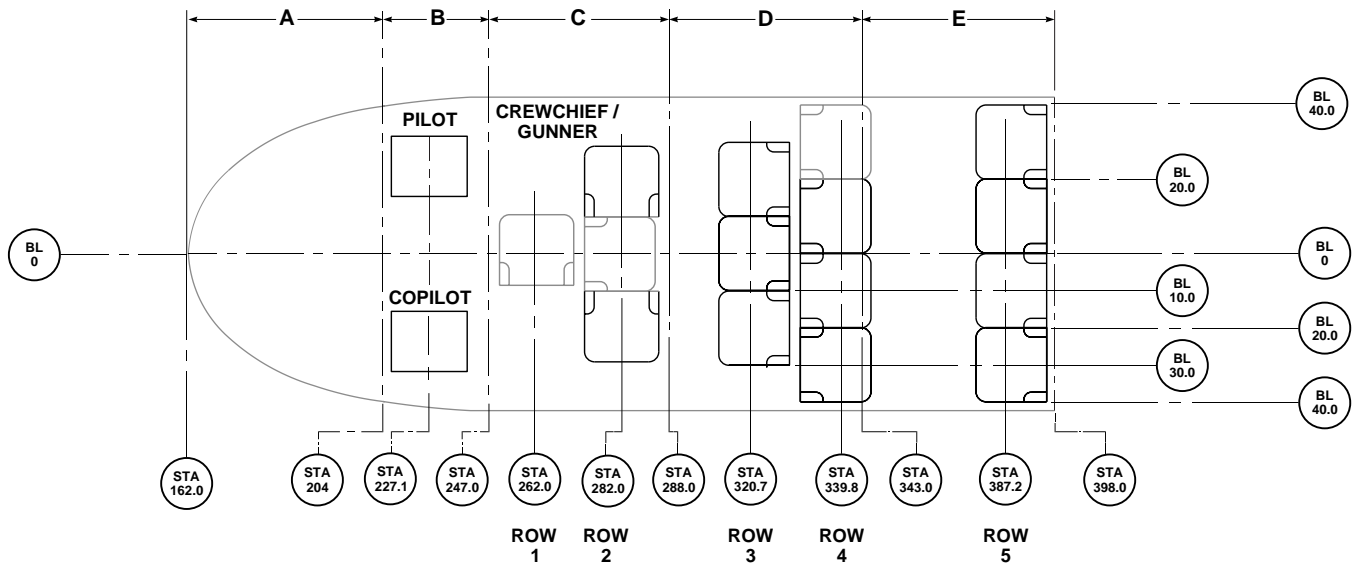

SEAT WEIGHT - AND MOMENT TABLE*

ITEM	ROW	WEIGHT	MOM / 1000
CREWCHEIF / GUNNER (2)	2	43	12
TROOPS (3)	3	48	15
TROOPS (3)	4	48	16
TROOPS (4)	5	63	25
TOTAL-12 SEATS		202	68
ALTERNATE SEATING (BROKEN LINES)			
FORWARD TROOP SEAT (1)	1	16	4
REAR FACING TROOP SEAT (1)	2	16	5
REAR FACING TROOP SEAT (1)	4	16	6
TOTAL-15 SEATS		250	83

*SEAT WEIGHT AND MOMENTS SHOULD BE INCLUDED ON CHART C

EXAMPLE

WANTED:
PERSONNEL MOMENTS

KNOWN:
2 PERSONNEL IN ROW 3
TOTAL WEIGHT 480 POUNDS

METHOD:
ENTER WEIGHT AT 480 POUNDS—MOVE RIGHT TO ROW 3.
MOVE DOWN. READ MOMENT / 1000=154

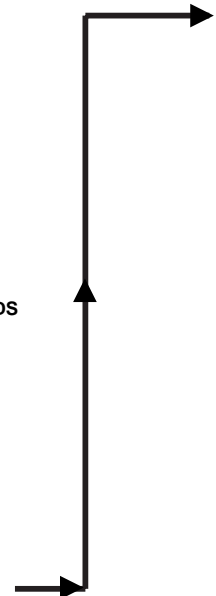
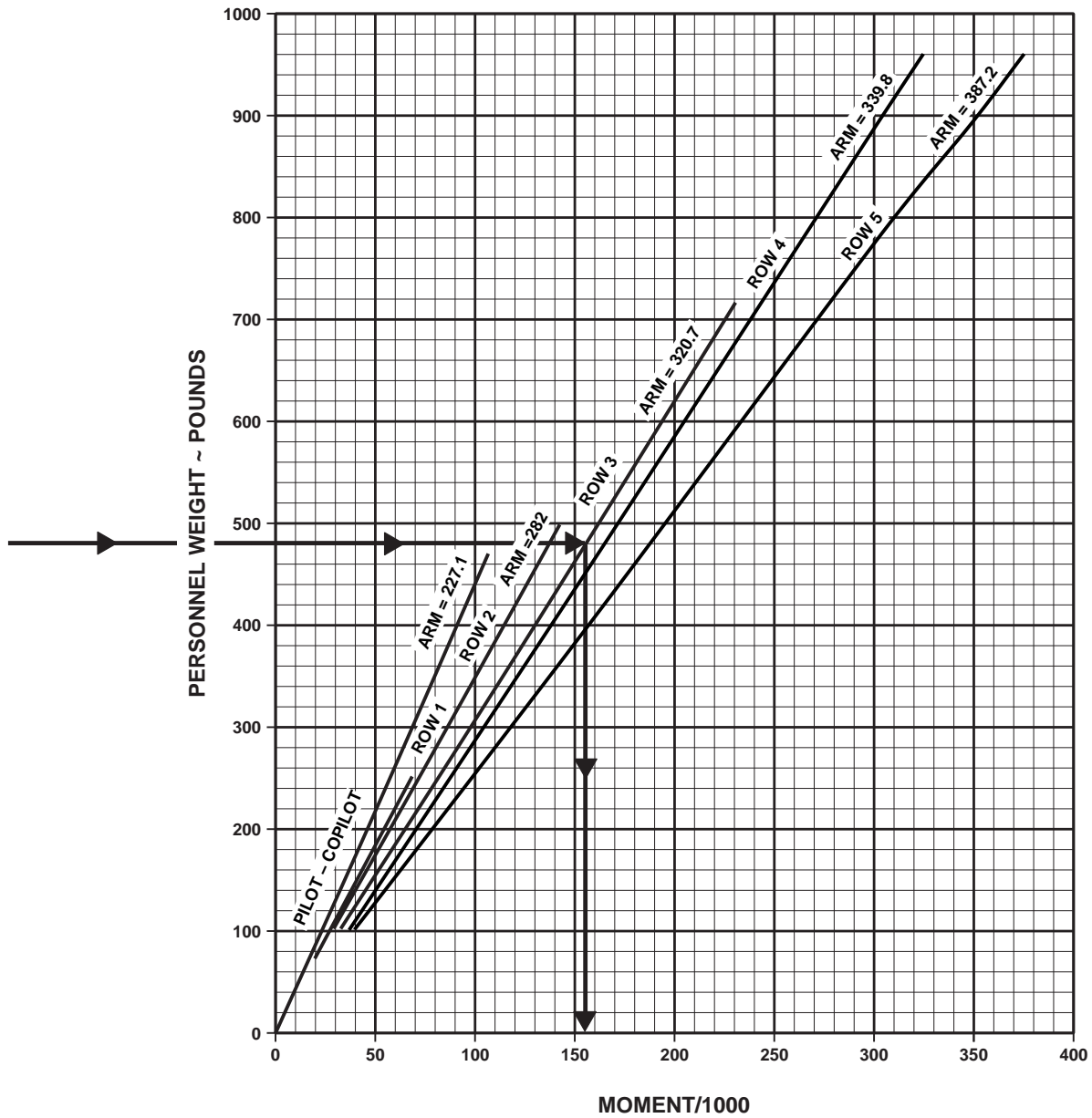

Figure 6-3. Personnel Moments (Troop Configuration) (Sheet 1 of 3) UH

PERSONNEL MOMENTS



DATA BASIS: CALCULATED

AA0669_2
SA

Figure 6-3. Personnel Moments (Troop Configuration) (Sheet 2 of 3) UH

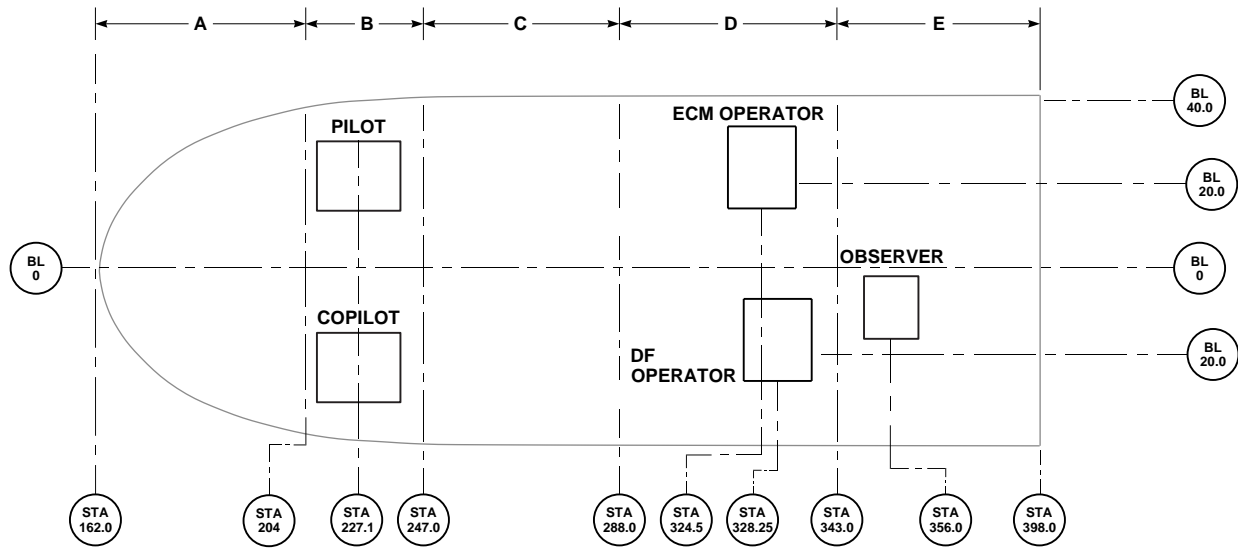

* ITEM	STA	WEIGHT	MOM / 1000
OBSERVER SEAT	356.0	18	6
TOTAL - 1 SEAT	-	18	6

* SEAT WEIGHT AND MOMENTS SHOULD BE INCLUDED ON CHART C.

EXAMPLE
WANTED
 PERSONNEL MOMENTS

KNOWN
 PERSONNEL AT STA 356
 OBSERVER - 210 POUNDS

METHOD
 ENTER WEIGHT AT 210 POUNDS - MOVE RIGHT TO OBSERVER ARC (STA 356.0) - MOVE DOWN READ MOMENT / 1000 = 75

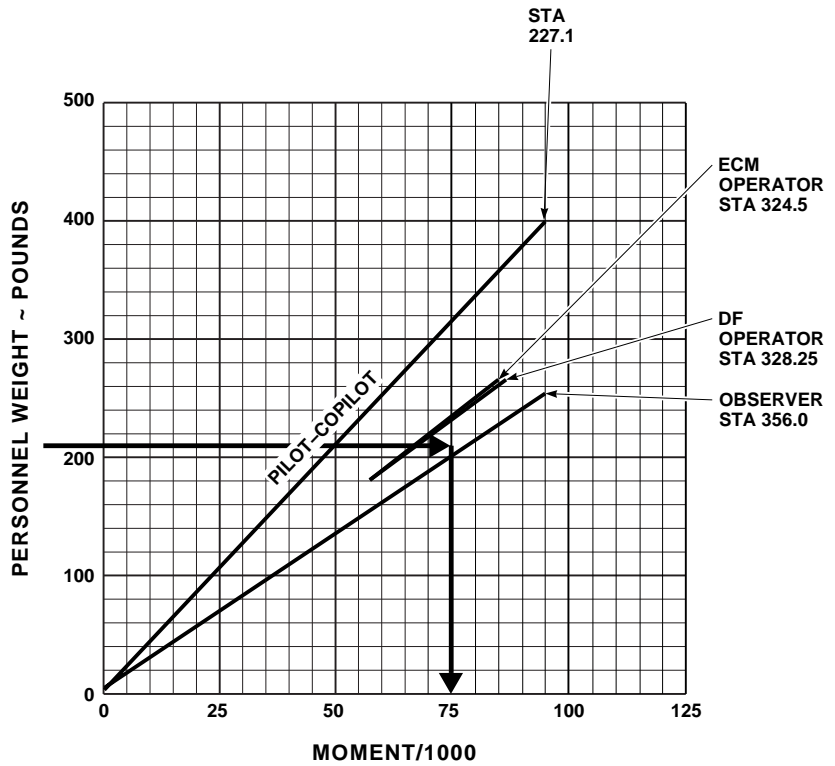

DATA BASIS: CALCULATED

AA0669_3B
 SA

Figure 6-3. Personnel Moments (EH Configuration) (Sheet 3 of 3) **EH**

LITTER MOMENTS

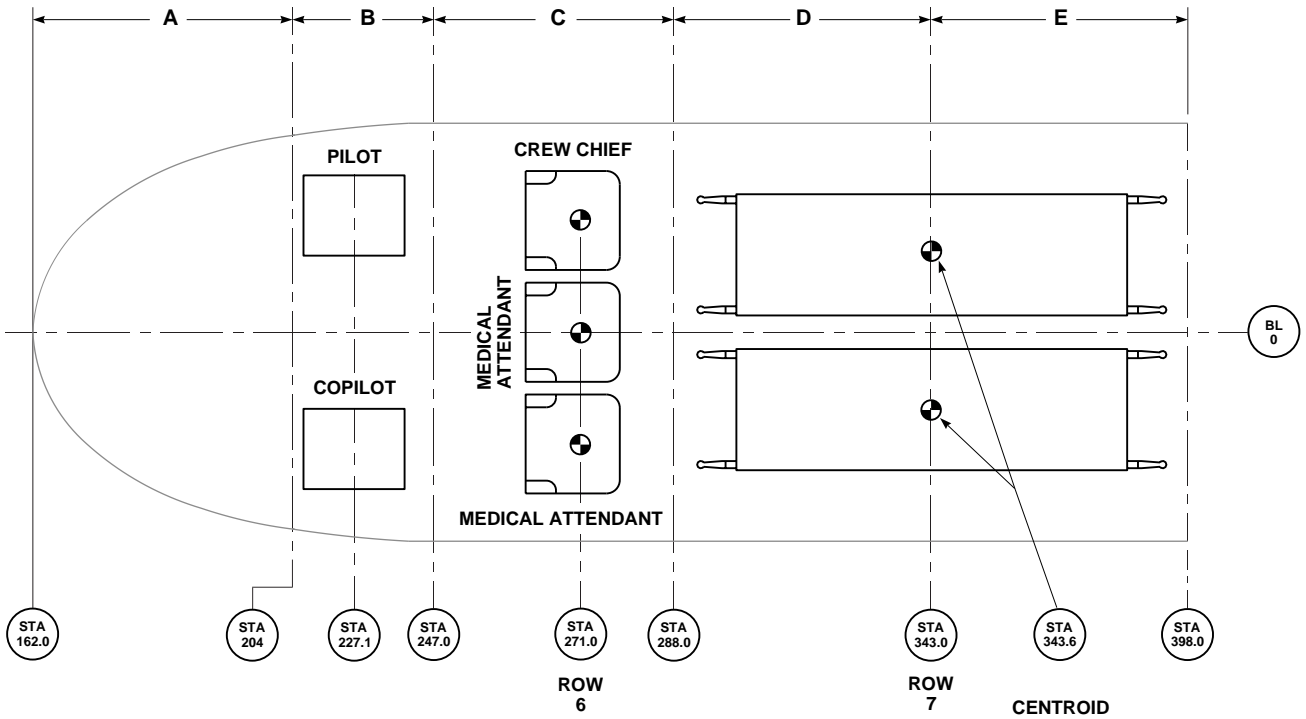

EXAMPLE

WANTED

LITTER MOMENTS

KNOWN

LITTER WEIGHT
= 265 POUNDS

METHOD

ENTER WEIGHT AT
265 POUNDS - MOVE
RIGHT TO LITTER
ROW 7
MOVE DOWN. READ
MOMENT / 1000 = 91

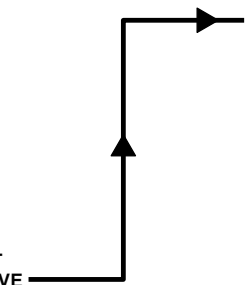

AA0378_1A
SA

Figure 6-4. Personnel Moments (Medevac Configuration) (Sheet 1 of 2)

LITTER MOMENTS

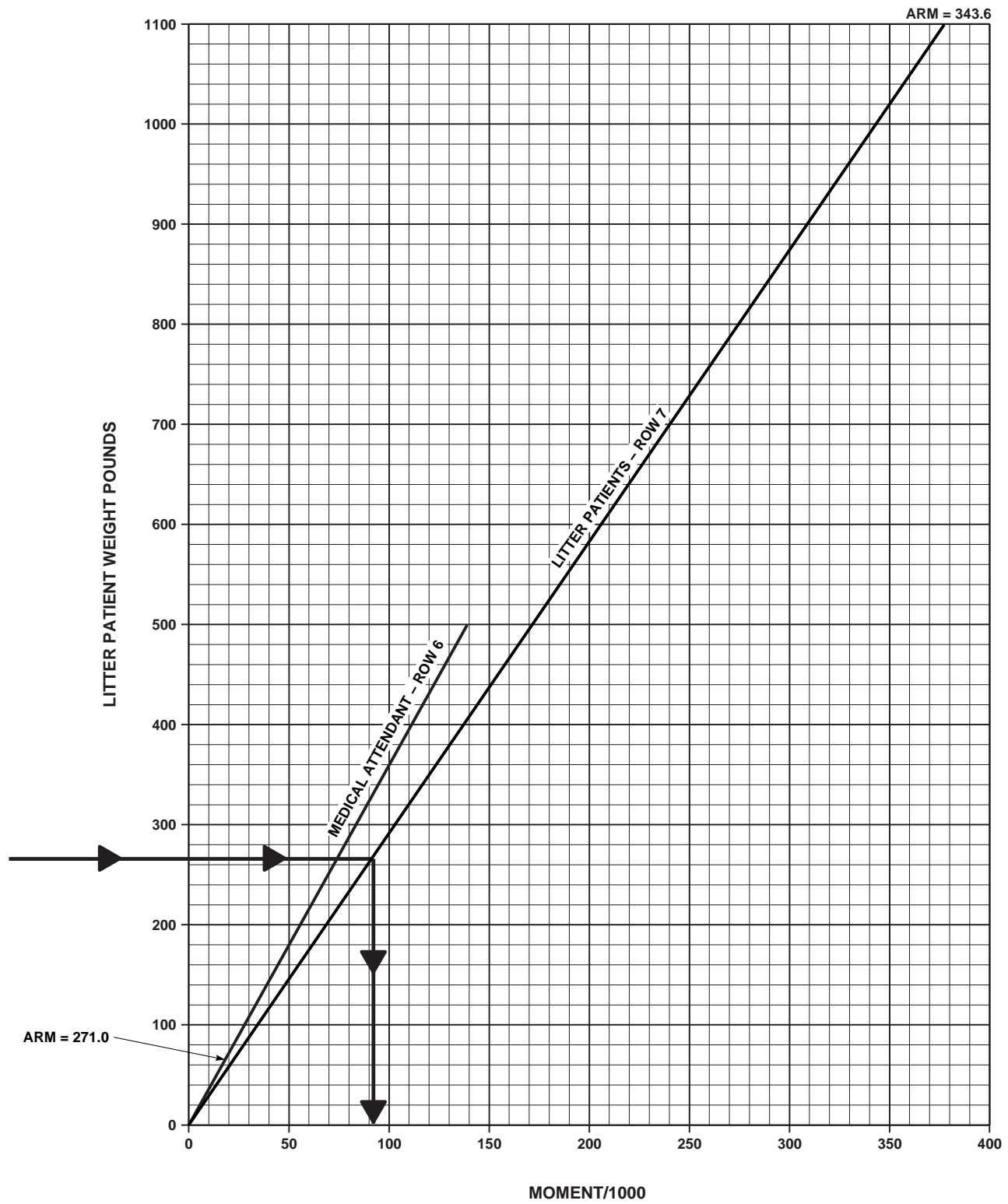

DATA BASIS:CALCULATED

AA0378_2A
SA

Figure 6-4. Personnel Moments (Medevac Configuration) (Sheet 2 of 2)

Section V MISSION EQUIPMENT

6.13 ARMAMENT LOADING DATA MOMENTS.

Armament consists of two M60D machineguns, ammunition, and grenades. Various loads of ammunition are presented in Figure 6-5. When determining the moments for a given ammo load not shown on the chart, go to the nearest load shown. **VOL** Volcano mine moments are presented in Figure 6-6.

6.14 EH-60A HELICOPTERS WITHOUT MISSION EQUIPMENT.

EH When operating without EH-60 mission equipment or with a light cabin load or no cabin load, it may be necessary to limit fuel load to remain within aft CG limits.

ARMAMENT LOADING DATA

AMMUNITION TABLE

LIVE ROUNDS	LIVE AMMO (7.62 MM) ARM - 247.0	
	WEIGHT - LB	MOM / 1000
100	7	2
200	13	3
300	20	5
400	26	6
500	32	8
600	39	10
700	46	11
800	52	13
ARM - 279.8		
LIVE ROUNDS	WEIGHT - LB	MOM / 1000
100	7	2
200	13	4
300	20	5
400	26	7

CHAFF

CHAFF CARTRIDGE MI. 30 RDS ARM - 505.0 (SINGLE CHAFF WEIGHT 0.33 LB)	
WEIGHT - LB	MOM / 1000
10	5

FLARE **EH**

FLARE DISPENSED M130, 30 RDS ARM - 525.0 (SINGLE FLARE WEIGHT 0.43 LB)	
WEIGHT - LB	MOM / 1000
13	7

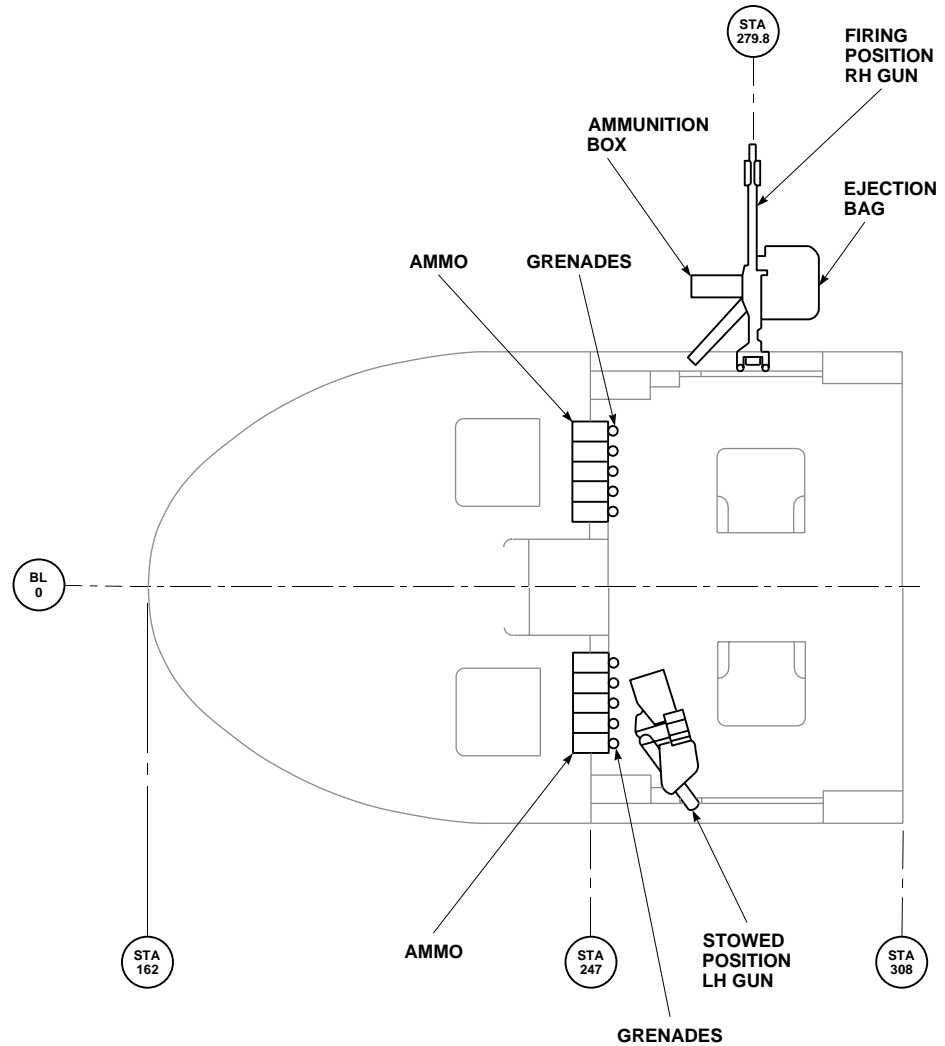

(GUN STOWED AND FIRING POSITIONS ARE SAME EACH SIDE)

GRENADE TABLE

QUANTITY	STOWED			
	GRENADE AN-M8 ARM - 251.0		GRENADE M18 ARM - 251.0	
	WEIGHT - LB	MOM / 1000	WEIGHT - LB	MOM / 1000
2	3	1	2	1
4	6	2	5	1
6	9	2	7	2
8	12	3	10	2
10	15	4	12	3
12	18	5	14	4

M60D TABLE

ITEM	WEIGHT	MOM / 1000	
		STOWED	FIRING POSITION
M60D (2)	45.4	12	13
EJECTION BAG (2)	9.0	2	3
AMMO BOX (2)	3.4	1	1
STORAGE BOX (2)	2.6	1	1
SUPPORT (2)	20.2	5	6
BIPOD (2)	4.0	1	1
TOTAL	84.6	22	25

DATA BASIS: CALCULATED

AA0375B
SA

Figure 6-5. Armament Loading Data Moments

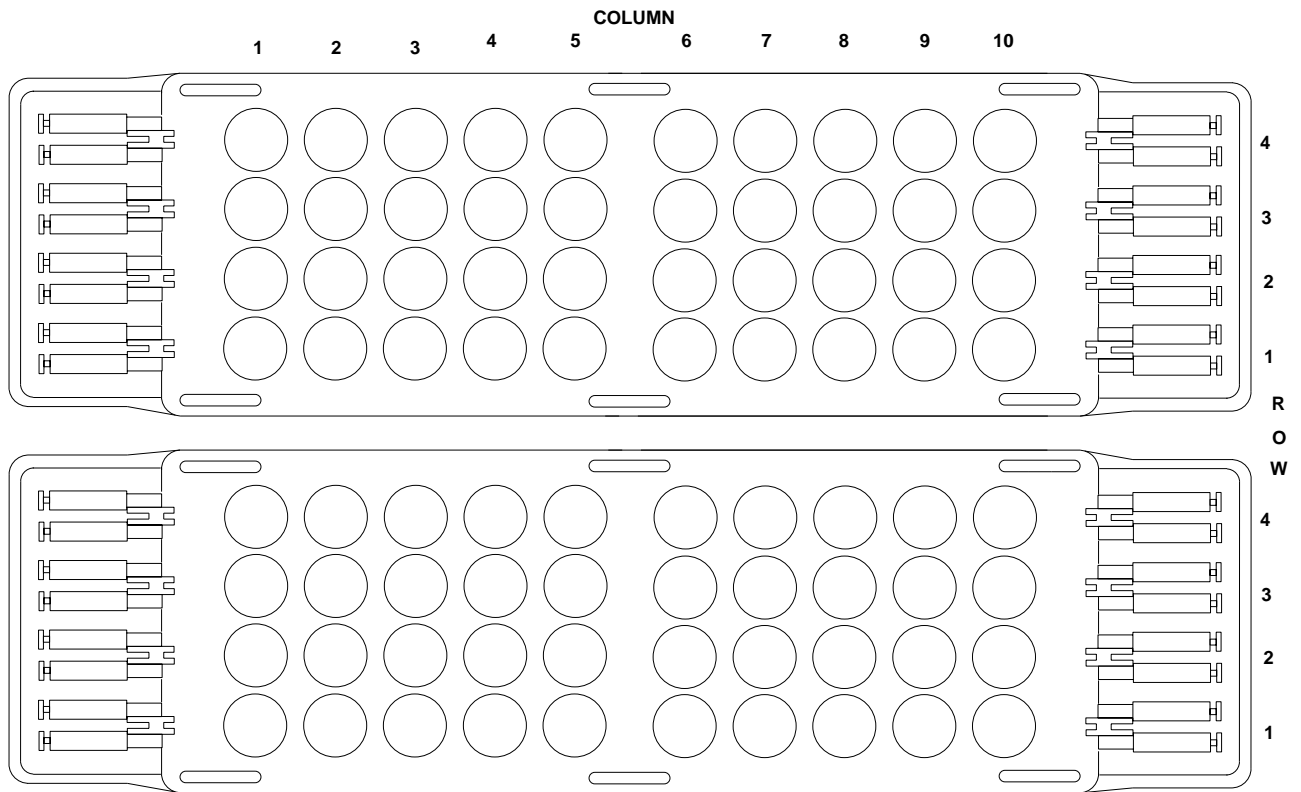

CANISTER COLUMN REFERENCE

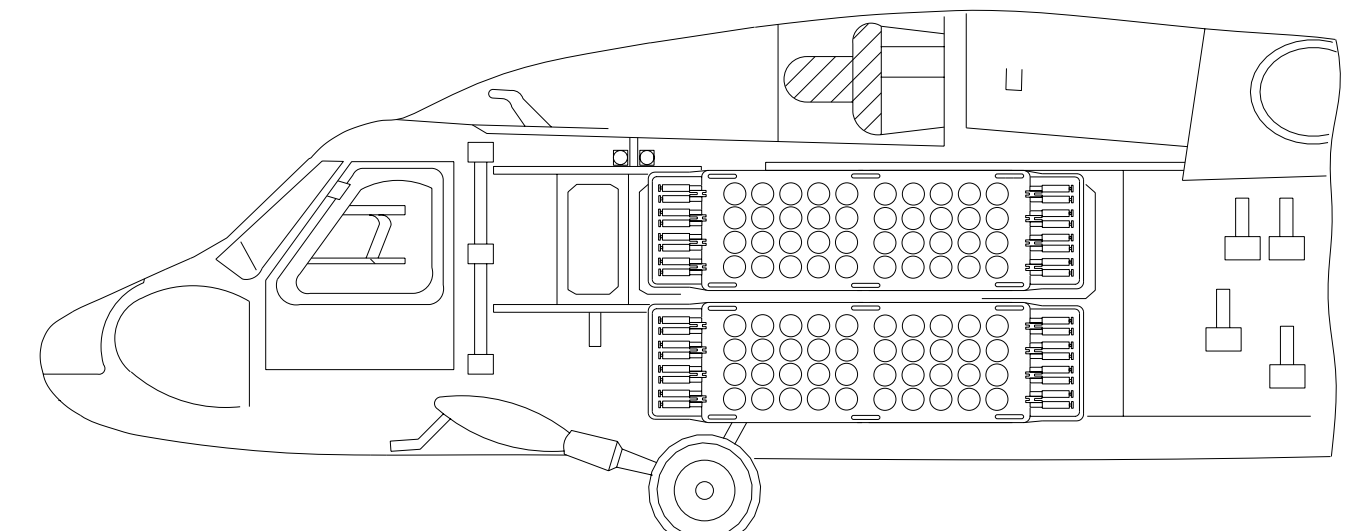

AA9415
SA

Figure 6-6. Volcano Mine Moments **VOL** (Sheet 1 of 2)

RACK WEIGHTS (PER RACK)								
NO CANISTERS			EMPTY CANISTERS (40)			FULL CANISTERS (40)		
Weight (lb)	Arm	Moment/ 1000	Weight (lb)	Arm	Moment/ 1000	Weight (lb)	Arm	Moment/ 1000
226	331.5	74.9	434	331.5	143.9	1450	331.5	480.7

	WEIGHT (LB)	QUANTITY PER SYSTEM	TOTAL WEIGHT (LB)	ARM	MOMENT/1000
Rack Without Canisters	226	4	904	331.5	299.7
Canisters:					
Empty	5.2	160	832	331.5	275.8
Full	30.6	160	4896	331.5	1623.0
Side Panels	236	2	472	322.8	152.4
DCU with Pallet	87	1	87	300	26.1
Cabling/ICP/Fairing /Cable Tubes	54	1	54	264.4	14.3
Total System	Full Canisters:		6413	329.7	2114.4
Total System	Empty Canisters		2349	326.7	767.4
Total System	No Canisters		1517	324.1	491.6

UNIT CANISTER LOADING					
COLUMN	EMPTY CANISTER WEIGHT	FULL CANISTER WEIGHT	ARM	EMPTY CANISTER MOMENT/1000	FULL CANISTER MOMENT/1000
1	5.2	30.6	306.3	1.6	9.4
2	5.2	30.6	311.8	1.6	9.5
3	5.2	30.6	317.3	1.6	9.7
4	5.2	30.6	322.8	1.7	9.9
5	5.2	30.6	328.3	1.7	10.0
6	5.2	30.6	333.8	1.7	10.2
7	5.2	30.6	339.3	1.8	10.4
8	5.2	30.6	344.8	1.8	10.6
9	5.2	30.6	350.3	1.8	10.7
10	5.2	30.6	355.8	1.9	10.9

Figure 6-6. Volcano Mine Moments VOL (Sheet 2 of 2)

CARGO MOMENTS – CARGO HOOK

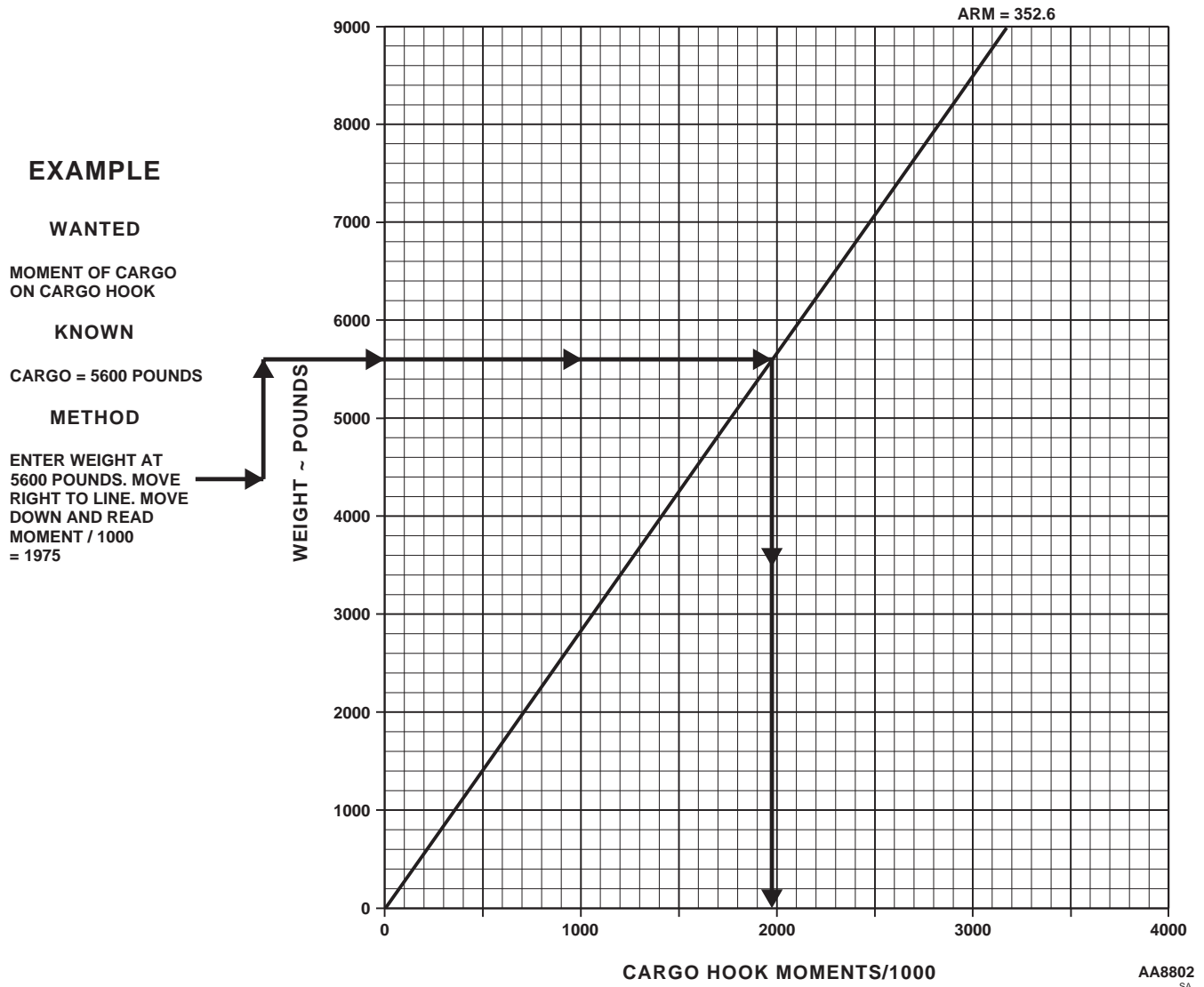

Figure 6-7. Cargo Hook Moments

RESCUE HOIST MOMENTS

EXAMPLE

WANTED

MOMENT OF RESCUE
HOIST LOAD

KNOWN

RESCUE HOIST LOAD
= 380 POUNDS

METHOD

ENTER WEIGHT AT
380 POUNDS - MOVE
RIGHT TO LINE. MOVE
DOWN. READ MOMENT /
1000 = 140

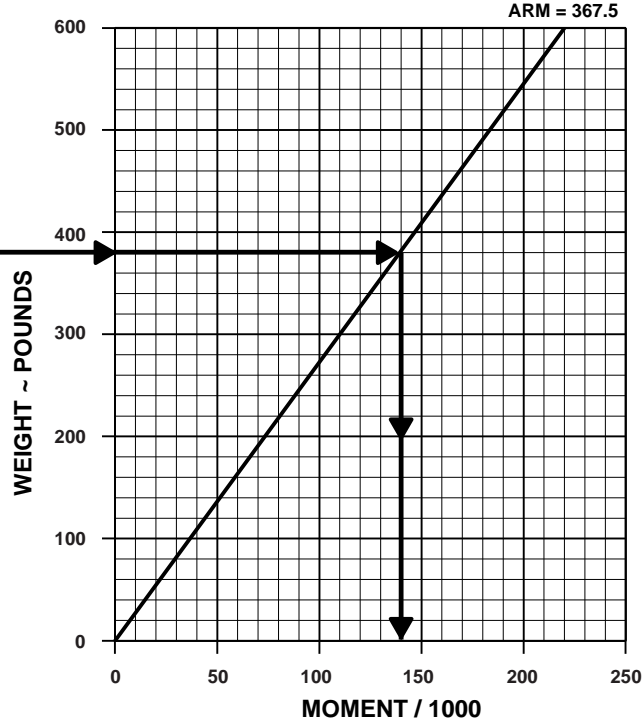

DATA BASIS: CALCULATED

AA0377
SA

Figure 6-8. Rescue Hoist Moments

Section VI CARGO LOADING

6.15 CABIN DIMENSIONS.

Refer to Figure 6-9 for dimensions. For loading, and weight and balance purposes, the helicopter fuselage is divided into six compartments, A through F, three of which are in the cabin, C, D, and E. There are 17 tiedown fittings rated at 5,000 pounds each. Cargo carrier restraint rings are at stations 308 and 379, to cover the 71 inches of longitudinal space. Cargo tiedown devices are stored in the equipment stowage space of compartment F.

6.16 CABIN DOORS.

Cabin doors are at the rear of the cargo compartment on each side of the fuselage. The door openings are 54.5 inches high and 69 inches wide; maximum package sizes accommodated by the openings are 54 inches high by 68 inches wide and are shown on Figure 6-10.

6.17 MAXIMUM CARGO SIZE DIAGRAM FOR LOADING THROUGH CABIN DOORS.

Figure 6-10 shows the largest size of cargo of various shapes that can be loaded into the cabin through the cabin doors.

6.18 TIEDOWN FITTINGS AND RESTRAINT RINGS.

The 17 tiedown fittings (Figure 6-11) installed on the cargo floor can restrain a 5,000-pound load in any direction. All tiedown fittings incorporate studs that are used to install the troop seats. Eight net restraint rings in the cargo compartment prevent cargo from hitting the bulkhead at station 398, or entering the crew area. Each restraint ring is rated at 3500-pound capacity in any direction.

6.19 EQUIPMENT STOWAGE COMPARTMENTS.

Equipment stowage compartment moments are shown in Figure 6-12.

6.20 EQUIPMENT LOADING AND UNLOADING.

6.20.1 Data Prior to Loading. The following data should be assembled or gathered by the loading crew before loading (Refer to FM 55-450-2, Army Helicopter Internal Load Operations):

- a. Weight of the individual items of cargo.
- b. Overall dimensions of each item of cargo (in inches).

- c. The helicopter's center of gravity.
- d. Floor loads for each item of cargo.
- e. Any shoring that may be required.
- f. When required, the location of the center of gravity of an individual item of cargo.

6.20.2 Cargo Center of Gravity Planning. The detail planning procedure consists of four steps, as follows:

- a. Determine ALLOWABLE LOAD from LIMITATIONS section of DD Form 365-4.
- b. Plan the location in the helicopter for the individual items of cargo. Since the CG of the load is determined by the station method, then specific locations must be assigned to each item of cargo.
- c. Determine the CG of the cargo load as planned. Regardless of the quantity, type, or size of cargo, use the station method.

d. Determine the CG of the fully-loaded helicopter from Figures 6-13 and 6-14, and if the CG of the helicopter falls within allowable limits. If it does, the cargo can be loaded. If not, the planned location of the individual items must be changed until an acceptable loading plan is obtained. When cargo loads consists of more than one item, the heavier items of cargo should be placed so that their CG is about in the center of the cabin, and the lighter items of cargo are forward and rear of them.

6.20.3 Restraint Criteria. The amount of restraint that must be used to keep the cargo from moving in any direction is called the "restraint criteria" and is usually expressed in units of the force of gravity, of Gs. Following are the units of the force of gravity or Gs needed to restrain cargo in four directions:

	Cargo
Forward	12 Gs
Rear	3 Gs
Lateral	8 Gs
Vertical	3 Gs (Up) 3 Gs (Down)

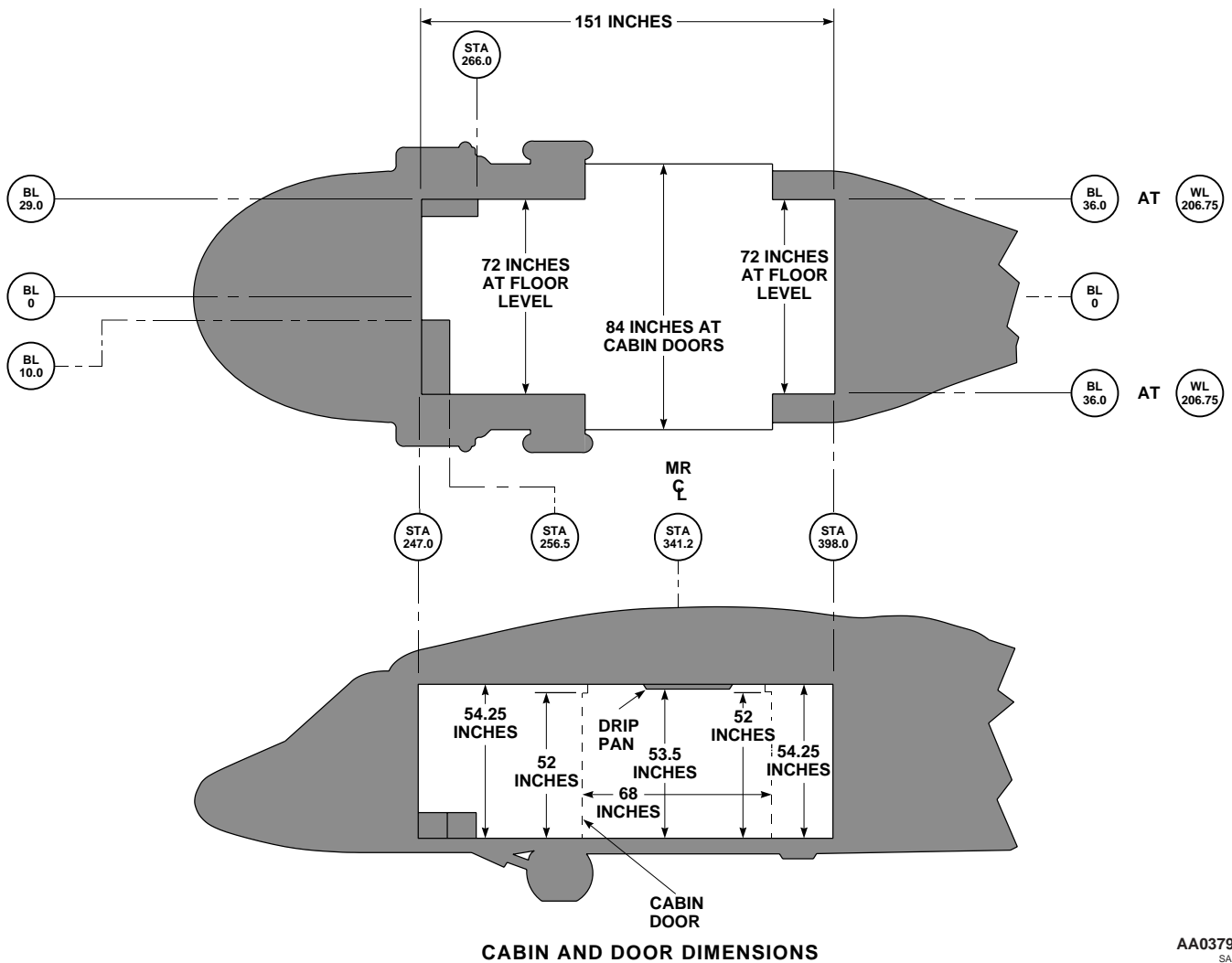
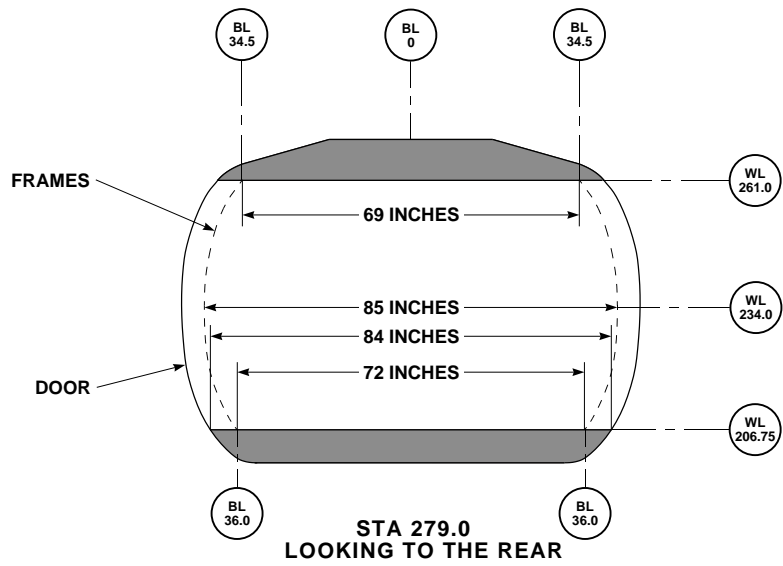
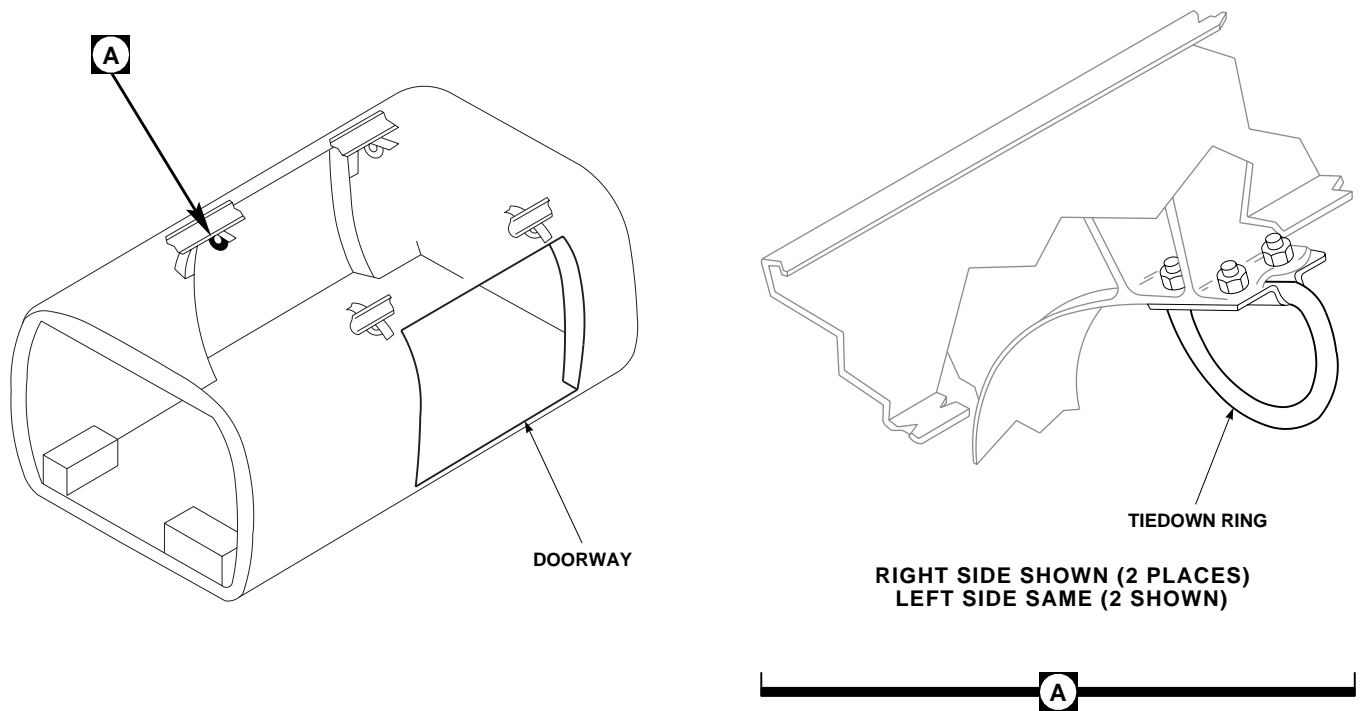

Figure 6-9. Cabin Dimensions

AA0379
SA



**MAXIMUM PACKAGE SIZE TABLE
CABIN DOORS**

WIDTH INCHES	HEIGHT - INCHES				
	50 & UNDER	51	52	53	54
	MAXIMUM LENGTH - INCHES				
46	102	102	102	96	93
48	102	102	102	96	93
50	101	101	101	95	92
52	100	100	100	94	92
54	99	99	99	93	91
56	98	98	98	93	91
58	97	97	97	93	91
60	96	96	96	91	90
62	93	93	93	89	87
64	91	91	91	87	
66	86	86	86	80	
68	80	80	80	77	

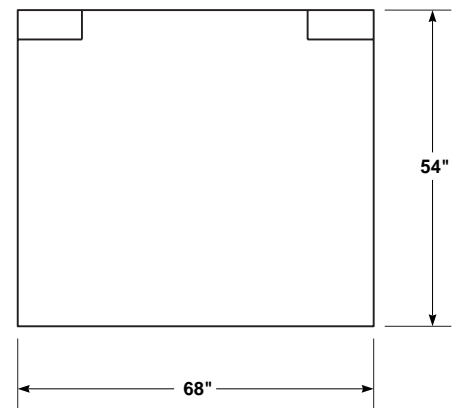

CABIN DOOR - BOTH SIDES

NOTE

IF GUNNERS AREA NOT USED,
LENGTHS ARE APPROXIMATELY 90%
OF TABLE VALUES.

AA0670
SA

Figure 6-10. Maximum Package Size for Cargo Door

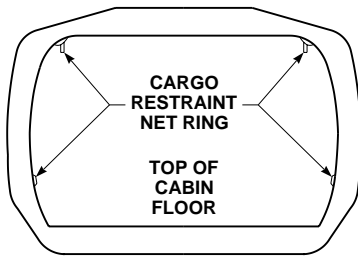

STA 308.0
LOOKING TO THE FRONT

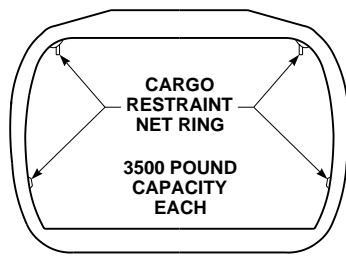

STA 379.0
LOOKING TO THE FRONT

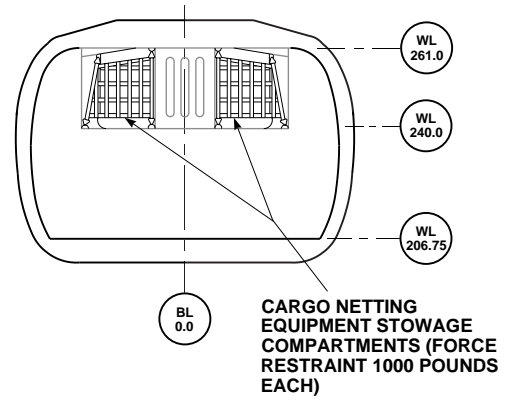

STA 402.19 - LOOKING TO THE REAR

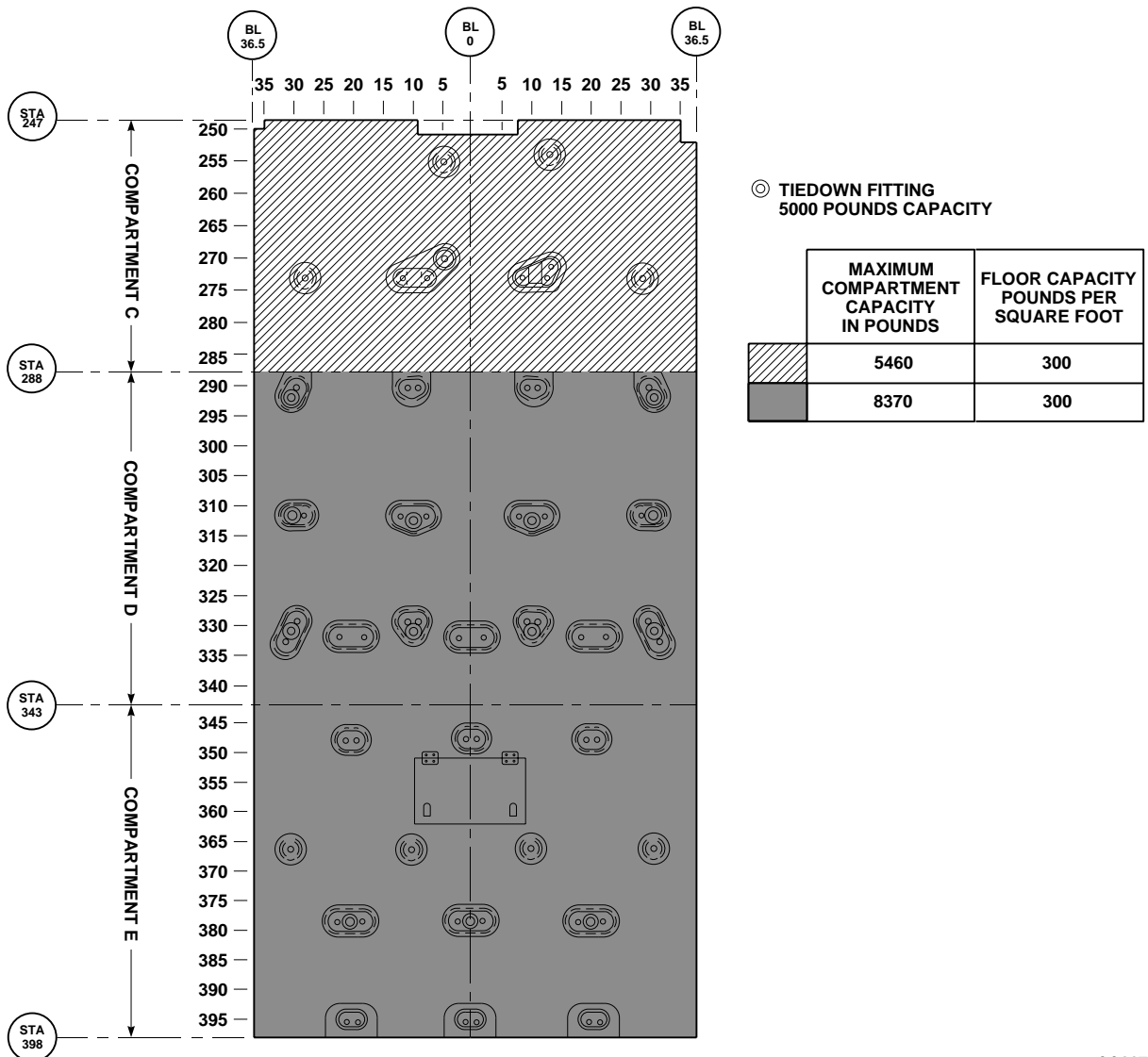
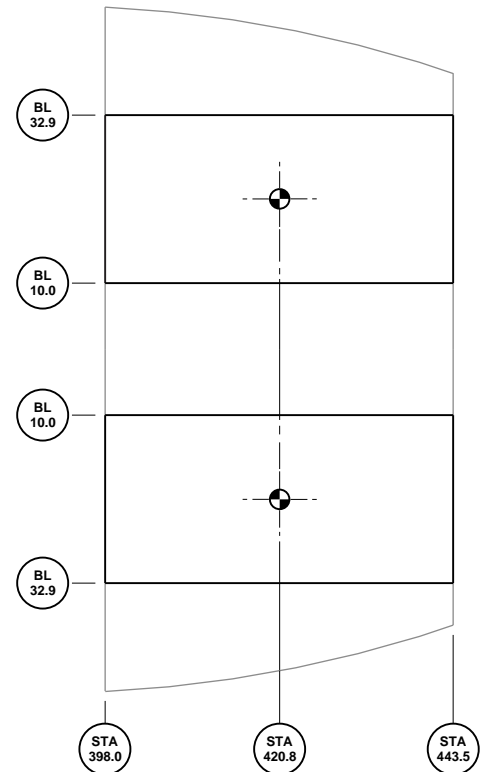

Figure 6-11. Cargo Tiedown Arrangement

STORAGE COMPARTMENT MOMENTS

STOWED SEAT TABLE

ITEM	ROW	WEIGHT	MOMENT / 1000
CREWCHIEF / GUNNER (2)	2	43	18
TROOPS (3)	3	48	20
TROOPS (3)	4	48	20
TROOPS (4)	5	63	27
TOTAL-12 SEATS		202	85
ALTERNATE (1)	1	16	7
ALTERNATE (1)	2	16	7
ALTERNATE (1)	4	16	7
TOTAL-15 SEATS		250	106



EXAMPLE

WANTED
MOMENT OF
STOWED EQUIPMENT

KNOWN
EQUIPMENT WEIGHT
= 125 POUNDS

METHOD
ENTER WEIGHT AT
125 POUNDS - MOVE
RIGHT TO LINE
MOVE DOWN READ
MOMENT / 1000 = 52

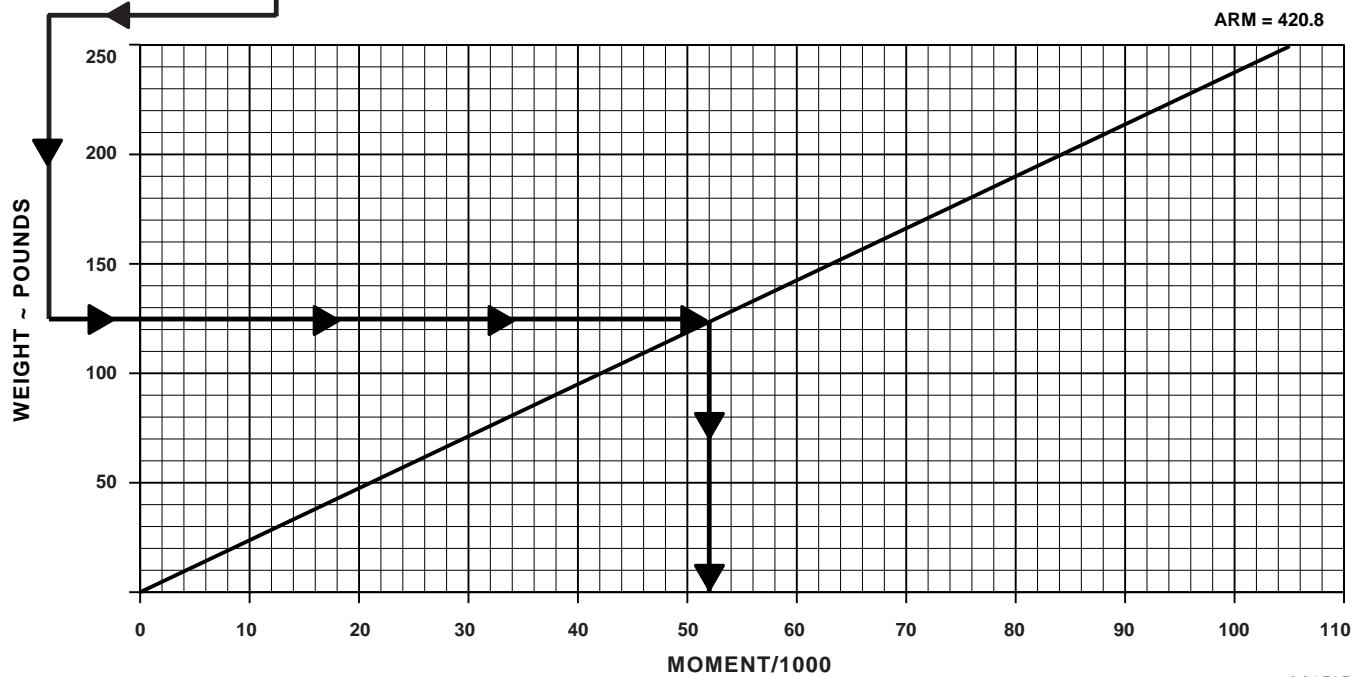

DATA BASIS: CALCULATED

AA0595
SA

Figure 6-12. Storage Compartment Moments

Section VII CENTER OF GRAVITY

6.21 CENTER OF GRAVITY LIMITS CHART.

- The CG limit charts (Figures 6-13 and 6-14) allow the center of gravity (inches) to be determined when the total weight and total moment are known.

CENTER OF GRAVITY

WITHOUT EXTERNAL STORES SUPPORT SYSTEM OR
VOLCANO MULTIPLE MINE DELIVERY SYSTEM INSTALLED
11,500 TO 16,500 POUNDS GROSS WEIGHT
CENTER OF GRAVITY LIMITS

EXAMPLE

WANTED

DETERMINE IF
LOADING LIMITS
ARE EXCEEDED

KNOWN

GROSS WEIGHT
= 15,000 POUNDS
MOMENT / 1000
= 5,400

METHOD

ENTER GROSS
WEIGHT AT 15,000
POUNDS. MOVE
RIGHT TOTAL
MOMENT / 1,000
= 5,400 CG
IS WITHIN LIMITS
MOVE DOWN TO
ARM = 360

EXAMPLE

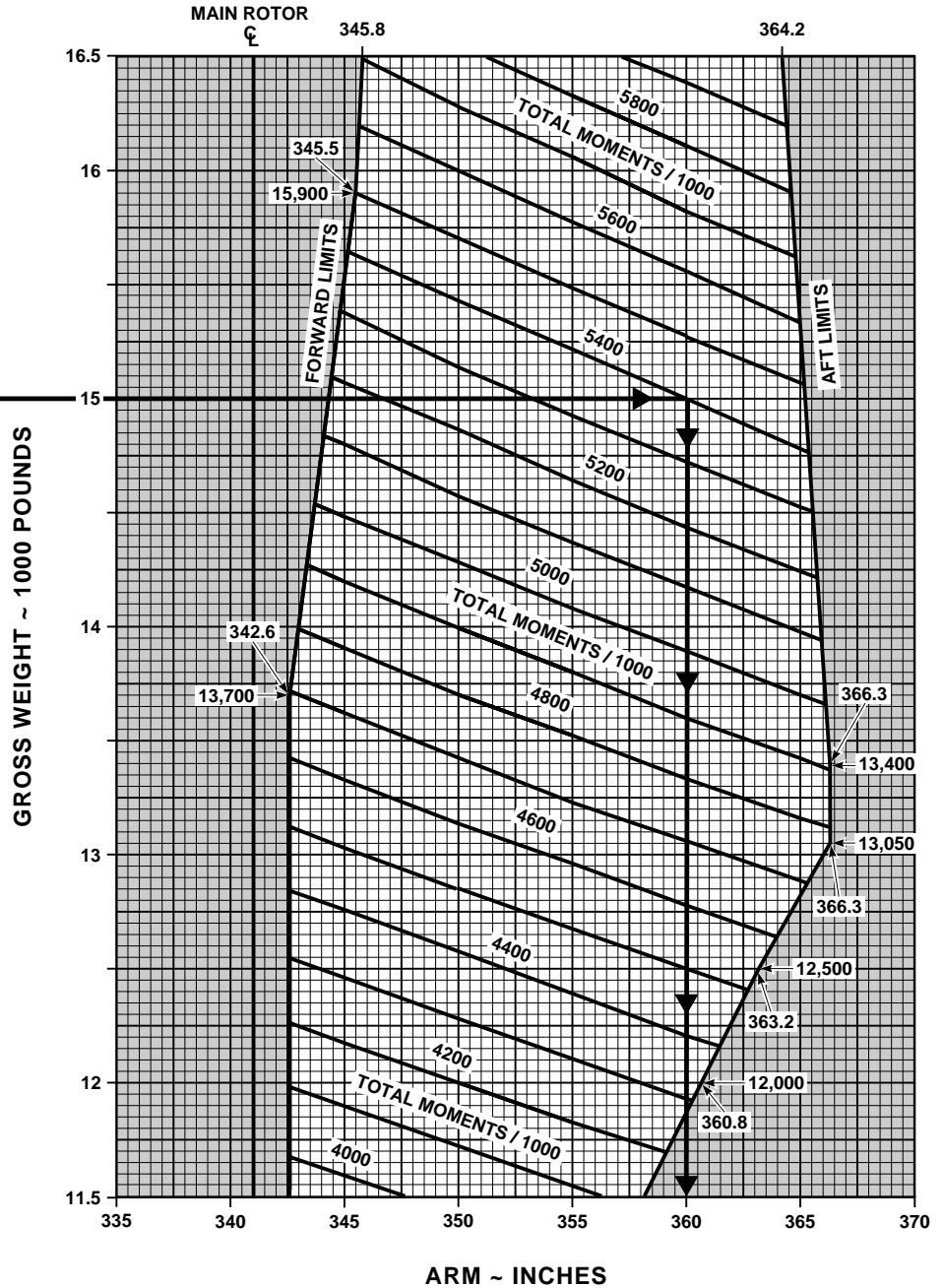

LEGEND	
BEYOND LIMITS	

DATA BASIS: CALCULATED

AA0347_1B
SA

Figure 6-13. Center of Gravity Limits Chart (Sheet 1 of 2)

CENTER OF GRAVITY

WITHOUT EXTERNAL STORES SUPPORT SYSTEM OR VOLCANO MULTIPLE MINE DELIVERY SYSTEM INSTALLED

16,000 TO 23,500 POUNDS GROSS WEIGHT

CENTER OF GRAVITY LIMITS

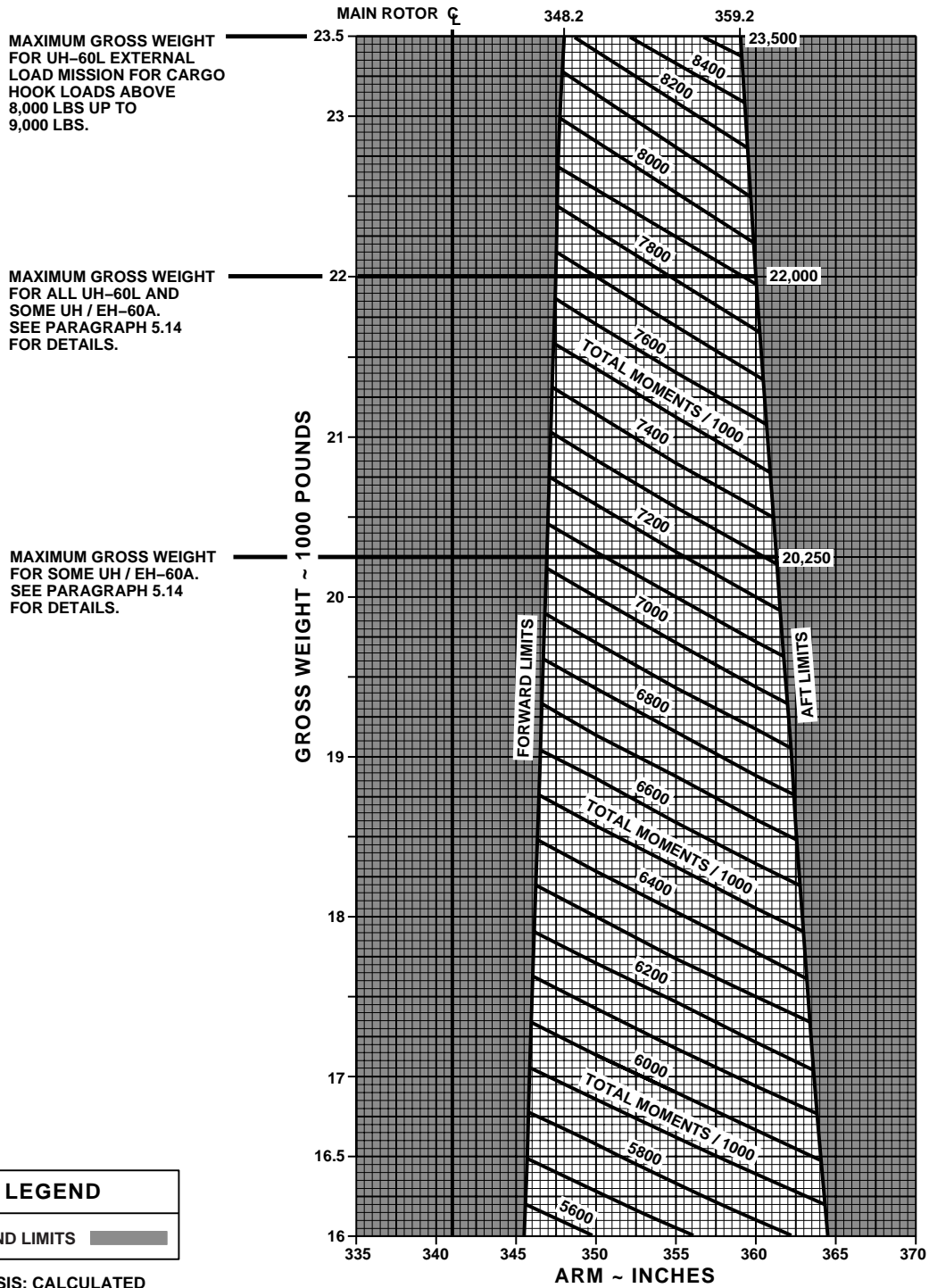

AA8801A
SA

Figure 6-13. Center of Gravity Limits Chart (Sheet 2 of 2)

CENTER OF GRAVITY

WITH EXTERNAL STORES SUPPORT SYSTEM INSTALLED

11,500 TO 16,500 POUNDS GROSS WEIGHT

CENTER OF GRAVITY LIMITS

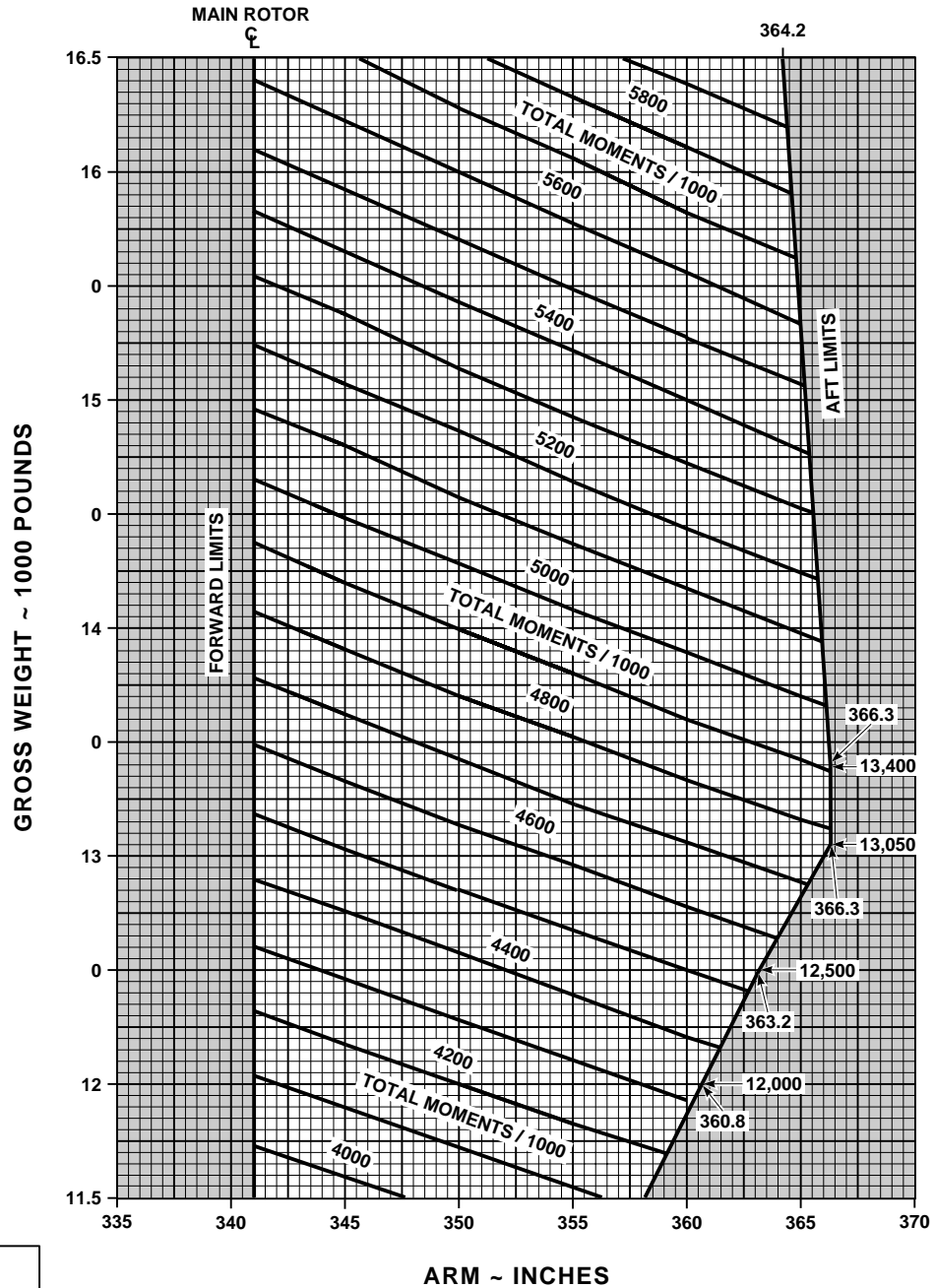

LEGEND	
BEYOND LIMITS	

DATA BASIS: CALCULATED

AA1254_1B
SA

Figure 6-14. Center of Gravity Limits Chart (Sheet 1 of 3)

CENTER OF GRAVITY

WITH EXTERNAL STORES SUPPORT SYSTEM OR
VOLCANO MULTIPLE MINE DELIVERY SYSTEM INSTALLED
16,000 TO 22,000 POUNDS GROSS WEIGHT
CENTER OF GRAVITY LIMITS

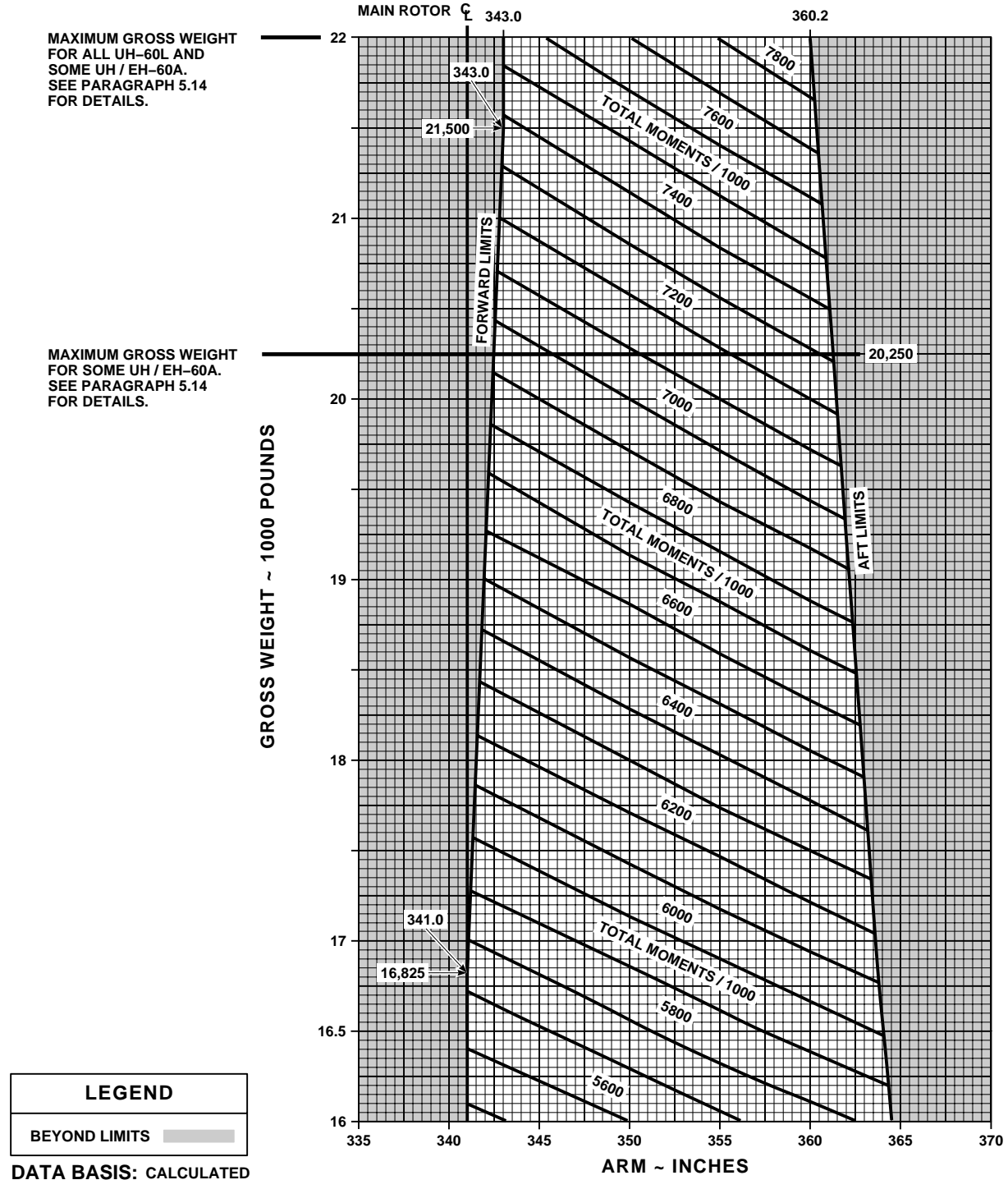

AA1254_2C
SA

Figure 6-14. Center of Gravity Limits Chart (Sheet 2 of 3)

CENTER OF GRAVITY

WITH EXTERNAL STORES SUPPORT SYSTEM OR VOLCANO MULTIPLE MINE DELIVERY SYSTEM INSTALLED

21,750 TO 24,500 POUNDS GROSS WEIGHT CENTER OF GRAVITY LIMITS

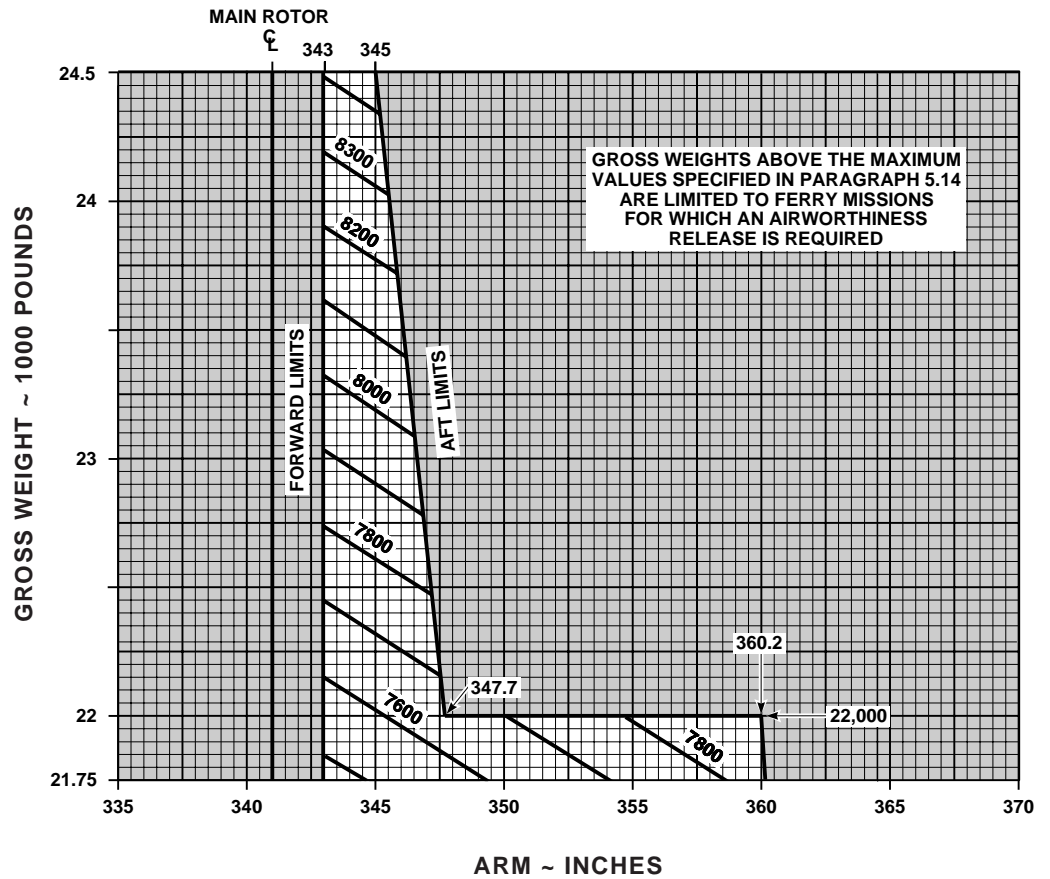

LEGEND

BEYOND LIMITS

DATA BASIS: CALCULATED

AA1254_3B
SA

Figure 6-14. Center of Gravity Limits Chart (Sheet 3 of 3)

CHAPTER 7

PERFORMANCE DATA

Section I INTRODUCTION

NOTE

Chapter 7 contains performance data for aircraft equipped with T700-GE-700 engines. Performance data for other models are contained in Chapter 7A. Users are authorized to remove whichever chapter is not applicable to their model aircraft, and are not required to carry both chapters on board.

Tabular performance data is presented in the checklist (TM 1 -1520-237-CL) and may be used in lieu of Figures 7-3 and 7-4 to obtain "Maximum Hover Weight", "Torque Required to Hover" and "Maximum Torque Available".

also be used in flight, to establish unit or area standard operating procedures, and to inform ground commanders of performance/risk trade-offs.

7.2 CHAPTER 7 INDEX.

The following index contains a list of the sections, titles, figure numbers, subjects and page numbers of each performance data chart contained in this chapter.

7.1 PURPOSE.

a. The purpose of this chapter is to provide the best available performance data. Regular use of this information will enable you to receive maximum safe utilization of the helicopter. Although maximum performance is not always required, regular use of this chapter is recommended for these reasons:

- (1) Knowledge of your performance margin will allow you to make better decisions when unexpected conditions or alternate missions are encountered.
- (2) Situations requiring maximum performance will be more readily recognized.
- (3) Familiarity with the data will allow performance to be computed more easily and quickly.
- (4) Experience will be gained in accurately estimating the effects of variables for which data are not presented.

b. The information is primarily intended for mission planning and is most useful when planning operations in unfamiliar areas or at extreme conditions. The data may

Section and Figure Number	Title	Page
I	INTRODUCTION	7-1
7-1	Temperature Conversion Chart.....	7-4
II	MAXIMUM TORQUE AVAILABLE.....	7-6
7-2	Aircraft Torque Factor (ATF)	7-7
7-3	Maximum Torque Available - 30-Minute Limit	7-8
III	HOVER.....	7-9
7-4	Hover - Clean Configuration	7-10
7-5	Hover - High Drag	7-12
IV	CRUISE	7-13
7-6	Sample Cruise Chart -Clean....	7-15
7-7	Cruise - Pressure Altitude Sea Level	7-16
7-8	Cruise High Drag - Pressure Altitude Sea Level.....	7-22
7-9	Cruise - Pressure Altitude 2,000 Feet	7-28

Section and Figure Number	Title	Page	Section and Figure Number	Title	Page
7-10	Cruise High Drag - Pressure Altitude 2,000 Feet.....	7-34	7-29	Optimum Altitude for Maximum Range	7-133
7-11	Cruise - Pressure Altitude 4,000 Feet	7-40	VI	DRAG	7-135
7-12	Cruise High Drag - Pressure Altitude 4,000 Feet.....	7-46	7-30	External Load Drag	7-136
7-13	Cruise - Pressure Altitude 6,000 Feet	7-52	7-31	Typical High Drag Configurations.....	7-137
7-14	Cruise High Drag - Pressure Altitude 6,000 Feet.....	7-58	VII	CLIMB - DESCENT.....	7-138
7-15	Cruise - Pressure Altitude 8,000 Feet	7-64	7-32	Climb/Descent.....	7-139
7-16	Cruise High Drag - Pressure Altitude 8,000 Feet.....	7-70	7-33	Climb/Descent - High Drag	7-140
7-17	Cruise - Pressure Altitude 10,000 Feet	7-76	VIII	FUEL FLOW.....	7-141
7-18	Cruise High Drag- Pressure Altitude 10,000 Feet.....	7-81	7-34	Single/Dual-Engine Fuel Flow.....	7-142
7-19	Cruise - Pressure Altitude 12,000 Feet	7-86	IX	AIRSPPEED SYSTEM CHARACTERISTICS	7-143
7-20	Cruise High Drag - Pressure Altitude 12,000 Feet.....	7-91	7-35	Airspeed Correction Aircraft Without Wedge Mounted Pitot-Static Probes....	7-144
7-21	Cruise - Pressure Altitude 14,000 Feet	7-96	7-36	Airspeed Correction Aircraft With Wedge Mounted Pitot-Static Probes	7-145
7-22	Cruise High Drag - Pressure Altitude 14,000 Feet.....	7-101	7-37	Airspeed Correction Chart - High Drag	7-146
7-23	Cruise - Pressure Altitude 16,000 Feet	7-106	X	SPECIAL MISSION PERFORMANCE.....	7-147
7-24	Cruise High Drag - Pressure Altitude 16,000 Feet.....	7-111	7-38	Self Deployment Mission Profile.....	7-148
7-25	Cruise - Pressure Altitude 18,000 Feet	7-115	7-39	Assault Mission Profile (4 - 230 Gallon Tanks).....	7-150
7-26	Cruise High Drag - Pressure Altitude 18,000 Feet.....	7-120	7-40	Assault Mission Profile (2 - 230 Gallon Tanks).....	7-151
7-27	Cruise - Pressure Altitude 20,000 Feet	7-124	7.3 GENERAL.		
7-28	Cruise High Drag - Pressure Altitude 20,000 Feet.....	7-128	The data presented covers the maximum range of con- ditions and performance that can reasonably be expected. In each area of performance, the effects of altitude, tem- perature, gross weight, and other parameters relating to that phase of flight are presented. In addition to the presented data, your judgment and experience will be necessary to		
V	OPTIMUM CRUISE	7-132			

accurately obtain performance under a given set of circumstances. The conditions for the data are listed under the title of each chart. The effects of different conditions are discussed in the text accompanying each phase of perfor-

mance. Where practical, data are presented at conservative conditions. However, **NO GENERAL CONSERVATISM HAS BEEN APPLIED**. All performance data presented are within the applicable limits of the helicopter. All flight per-

formance data are based on JP-4 fuel. The change in fuel flow and torque available, when using JP-5 or JP-8 aviation fuel, or any other approved fuels, is insignificant.

7.4 LIMITS.



Exceeding operating limits can cause permanent damage to critical components. Overlimit operation can decrease performance, cause early failure, or failure on a subsequent flight.

Applicable limits are shown on the charts. Performance generally deteriorates rapidly beyond limits. If limits are exceeded, minimize the amount and time. Enter the maximum value and time above limits on DA Form 2408-13-1, so proper maintenance action can be taken.

7.5 USE OF CHARTS.

7.5.1 Dashed Line Data. Weights above 22,000 pounds are limited to ferry missions for which an Airworthiness Release is required. On some charts dashed line data are shown for gross weights greater than 22,000 pounds.

7.5.2 Data Basis. The type of data used is indicated at the bottom of each performance chart under DATA BASIS. The data provided generally is based on one of three categories:

- a. Flight test data. Data obtained by flight test of the helicopter by experienced flight test personnel at precise conditions using sensitive calibrated instruments.
- b. Calculated data. Data based on tests, but not on flight test of the complete helicopter.
- c. Estimated data. Data based on estimates using aerodynamic theory or other means but not verified by flight test.

7.5.3 Specific Conditions. The data presented is accurate only for specific conditions listed under the title of each chart. Variables for which data is not presented, but which may affect that phase of performance, are discussed in the text. Where data is available or reasonable estimates can be made, the amount that each variable affects performance will be given.

7.6 PERFORMANCE DISCREPANCIES.

Regular use of this chapter will allow you to monitor instrument and other helicopter systems for malfunction, by comparing actual performance with planned performance. Knowledge will also be gained concerning the effects of variables for which data is not provided, thereby increasing the accuracy of performance predictions.

7.7 PERFORMANCE DATA BASIS - CLEAN.

The data presented in the performance charts are primarily derived for a clean UH-60A aircraft and are based on U. S. Army test data. The clean configuration assumes all doors and windows are closed and includes the following external configuration:

- a. Fixed provisions for the External Stores Support System (ESSS).
- b. Main and tail rotor deice system.
- c. Mounting brackets for IR jammer and chaff dispenser.
- d. The Hover Infrared Suppressor System (HIRSS) with baffles installed.
- e. Includes wire strike protection system.

NOTE

Aircraft which have an external configuration which differs from the clean configuration may be corrected for drag differences on cruise performance as discussed in Section VI DRAG.

7.8 PERFORMANCE DATA BASIS - HIGH DRAG.

The data presented in the high drag performance charts are primarily derived for the UH-60A with the ESSS system installed and the 230-gallon tanks mounted on the outboard pylons, and are based on U. S. Army test data. The high drag configuration assumes all doors and windows are closed and includes the following external configuration:

- a. External stores support system installed.
- b. Two 230-gallon tanks mounted on the outboard pylons.
- c. Inboard vertical pylons empty.
- d. IR jammer and chaff dispenser installed.

TEMPERATURE CONVERSION

EXAMPLE

WANTED:

FREE AIR TEMPERATURE IN DEGREES CELSIUS

KNOWN:

FREE AIR TEMPERATURE = 32°F

METHOD:

ENTER FREE AIR TEMPERATURE HERE
MOVE RIGHT TO DIAGONAL LINE
MOVE DOWN TO DEGREES CELSIUS SCALE
READ FREE AIR TEMPERATURE = 0°C

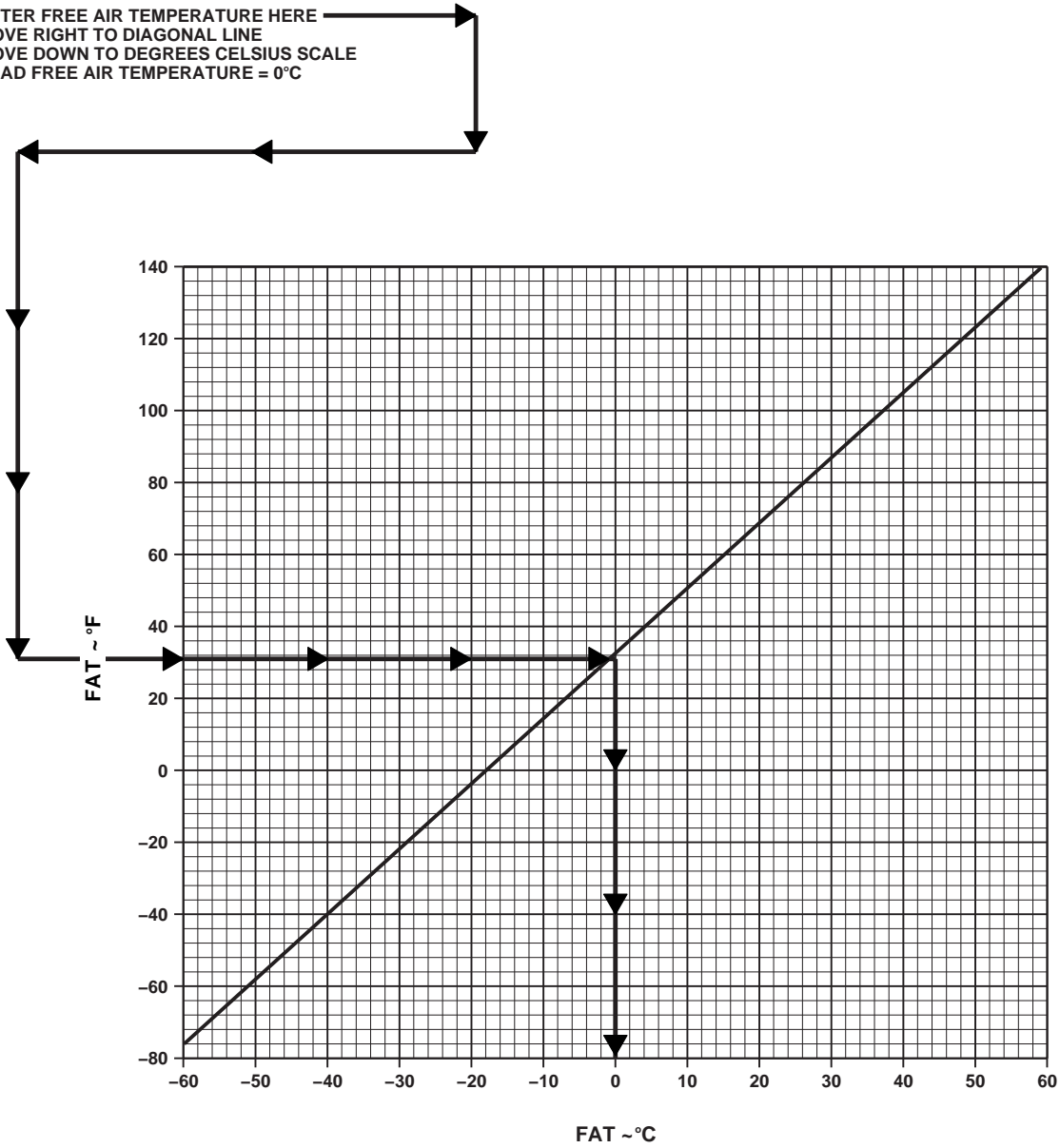

AA0674
SA

Figure 7-1. Temperature Conversion Chart

e. Hover Infrared Suppressor System (HIRSS) with baffles are installed.

f. Main and tail rotor deice and wire strike protection systems are installed.

NOTE

Aircraft with an external configuration that differs from the high drag configuration baseline may be corrected for differences in cruise performance as discussed in Section VI DRAG.

g. **VOL** Use the high drag configuration hover charts to determine hover performance with the volcano system

installed. Use the high drag cruise charts and the volcano drag correction factor to determine cruise performance with volcano installed. The volcano drag correction factor is based on flight test data obtained with the complete volcano system installed, to include all of the canisters and mines. The drag correction factor may be used to provide a conservative estimate of cruise performance for volcano configurations which do not include all of the canisters and mines.

7.9 FREE AIR TEMPERATURES.

A temperature conversion chart (Figure 7-1) is included for the purpose of converting Fahrenheit temperature to Celsius.

Section II MAXIMUM TORQUE AVAILABLE

7.10 TORQUE FACTOR METHOD.

The torque factor method provides an accurate indication of available power by incorporating ambient temperature effects on degraded engine performance. This section presents the procedure to determine the maximum dual- or single-engine torque available for the T700-GE-700 engine as installed in each individual aircraft. Specification power is defined for a newly delivered low time engine. The aircraft HIT log forms for each engine, provide the engine and aircraft torque factors which are obtained from the maximum power check and recorded to be used in calculating maximum torque available.

7.10.1 Torque Factor Terms. The following terms are used when determining the maximum torque available for an individual aircraft:

a. Torque Ratio (TR). The ratio of torque available to specification torque at the desired ambient temperature.

b. Engine Torque Factor (ETF). The ratio of an individual engine torque available to specification torque at reference temperature of 35°C. The ETF is allowed to range from 0.85 to 1.0.

c. Aircraft Torque Factor (ATF). The ratio of an individual aircraft's power available to specification power at a reference temperature of 35°C. The ATF is the average of the ETF's of both engines and its value is allowed to range from 0.9 to 1.0.

7.10.2 Torque Factor Procedure. The use of the ATF or ETF to obtain the TR from Figure 7-2 for ambient temperatures between -15°C and 35°C is shown by the example. The ATF and ETF values for an individual aircraft are found on the engine HIT Log. The TR always equals 1.0 for ambient temperatures of -15°C and below, and the TR equals the ATF or ETF for temperatures of 35°C and above. For these cases, and for an ATF or ETF value of 1.0, Figure 7-2 need not be used.

7.11 MAXIMUM TORQUE AVAILABLE CHART.

This chart (Figure 7-3) presents the maximum specification torque available at zero airspeed and 100% RPM R for the operational range of pressure altitude and FAT. The single- and dual-engine transmission limits for continuous operation are shown and should not be exceeded. The engine torque available data above the single-engine transmission limit is presented as dashed lines and is required for determining torque available when TR values are below 1.0. When the TR equals 1.0, the maximum torque available may be read from the horizontal specification torque available per engine scale. When the TR value is less than 1.0, the maximum torque available is determined by multiplying the TR by the specification torque available. The lower portion of Figure 7-3 presents TR correction lines which may be used in place of multiplication to read torque available per engine directly from the vertical scale.

7.12 ENGINE BLEED AIR.

With engine bleed air turned on, the maximum available torque is reduced as follows:

a. Engine Anti-Ice On: Reduce torque determined from Figure 7-3 by a constant 16% TRQ. Example: (90% TRQ - 16% TRQ) = 74% TRQ.

b. Cockpit Heater On: Reduce torque available by 4% TRQ.

c. Both On: Reduce torque available by 20% TRQ.

7.13 INFRARED SUPPRESSOR SYSTEM.

When the hover IR suppressor system is installed and operating in the benign mode exhaust (baffles removed) the maximum torque available is increased about 1% TRQ. When an IR suppressor system is not installed, maximum torque available is also increased about 1%.

TORQUE FACTOR

TORQUE FACTOR ~ ATF OR ETF

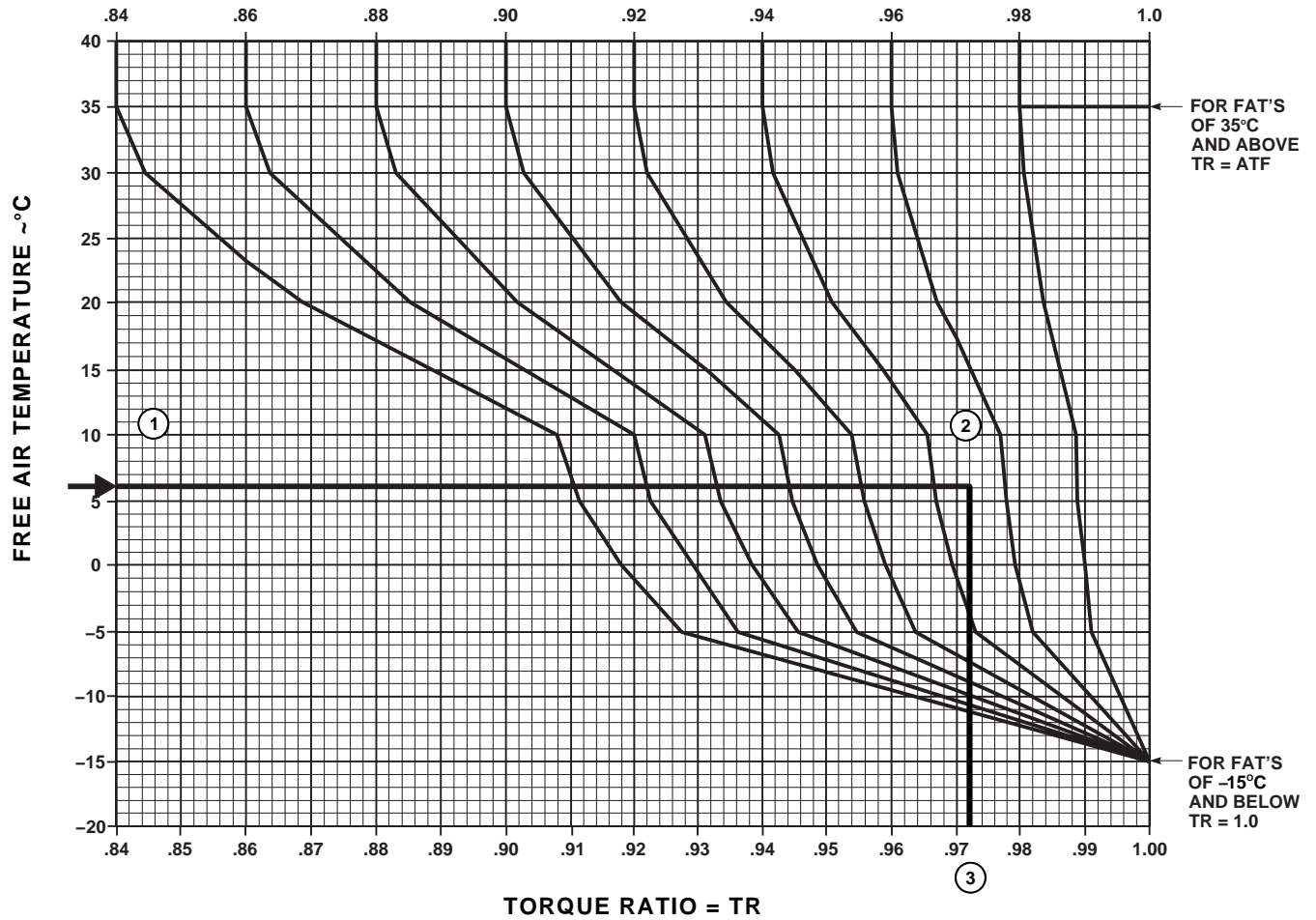

EXAMPLE

WANTED:

TORQUE RATIO AND MAXIMUM TORQUE AVAILABLE

KNOWN:

ATF = .95
 PRESSURE ALTITUDE = 6000 FT
 FAT = 6°C

METHOD:

TO OBTAIN TORQUE RATIO:

1. ENTER TORQUE FACTOR CHART AT KNOWN FAT
2. MOVE RIGHT TO THE ATF VALUE
3. MOVE DOWN, READ TORQUE RATIO = .972

TO CALCULATE MAXIMUM TORQUE AVAILABLE:

4. ENTER MAXIMUM TORQUE AVAILABLE CHART AT KNOWN FAT (FIGURE 7-3)
5. MOVE RIGHT TO KNOWN PRESSURE ALTITUDE
6. MOVE DOWN, READ SPECIFICATION TORQUE = 97.2%

TO OBTAIN VALUE FROM CHART:

7. MOVE DOWN TO TORQUE RATIO OBTAINED FROM FIGURE 7-2
8. MOVE LEFT, READ MAXIMUM TORQUE AVAILABLE = 93.0%

DATA BASIS: CALCULATED

AA0675A
 SA

Figure 7-2. Aircraft Torque Factor (ATF)

MAXIMUM TORQUE AVAILABLE

30 MIN LIMIT 100% RPM R HIRSS (BAFFLES INSTALLED)
ZERO AIRSPEED BLEED AIR OFF

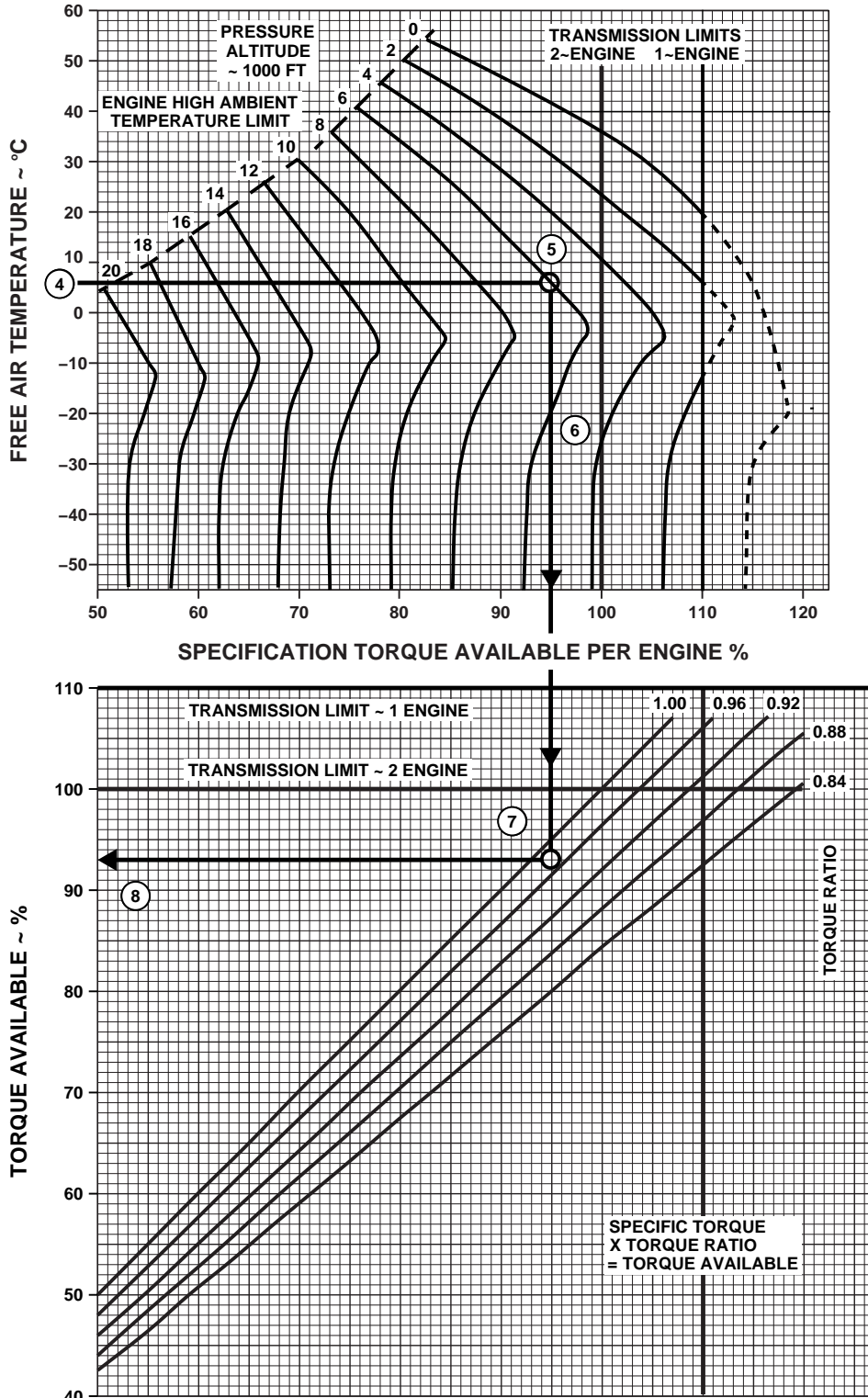

DATA BASIS: FLIGHT TEST

AA0381B
SA

Figure 7-3. Maximum Torque Available - 30-Minute Limit

Section III HOVER

7.14 HOVER CHART.

NOTE

VOL For performance calculations with volcano system installed, use the applicable high drag performance charts.

a. The primary use of the chart (Figures 7-4 through 7-5) is illustrated by part A of the example. To determine the torque required to hover, it is necessary to know pressure altitude, free air temperature, gross weight, and desired wheel height. Enter the upper right grid at the known free air temperature, move right to the pressure altitude, move down to gross weight. For OGE hover, move left to the torque per engine scale and read torque required. For IGE hover, move left to desired wheel height, deflect down and read torque required for dual-engine or single-engine operation. The IGE wheel height lines represent a compromise for all possible gross weights and altitude conditions. A small torque error up to $\pm 3\%$ torque may occur at extreme temperature and high altitude. This error is more evident at lower wheel heights.

b. In addition to the primary use, the hover chart (Figure 7-4) may be used to predict maximum hover height. To determine maximum hover height, it is necessary to know pressure altitude, free air temperature, gross weight, and maximum torque available. Enter the known free air temperature move right to the pressure altitude, move down to

gross weight, move left to intersection with maximum torque available and read wheel height. This wheel height is the maximum hover height.

c. The hover chart may also be used to determine maximum gross weight for hover at a given wheel height, pressure altitude, and temperature as illustrated in method B of the example (Figure 7-4). Enter at known free air temperature, move right to the pressure altitude, then move down and establish a vertical line on the lower grid. Now enter lower left grid at maximum torque available. Move up to wheel height, then move right to intersect vertical line from pressure altitude/FAT intersection. Interpolate from gross weight lines to read maximum gross weight at which the helicopter will hover.

7.15 EFFECTS OF BLADE EROSION KIT.

With the blade erosion kit installed, it will be necessary to make the following corrections. Multiply the torque required to hover determined from the charts by 1.02. (Example: If indicated torque is 90%, multiply $90 \times 1.02 = 91.8\%$ actual torque required.) Multiply the maximum gross weight to hover obtained from the charts by 0.98. (Example: If gross weight is 22,000 lb, multiply by 0.98 = 21,560 lb actual gross weight to hover.) When determining maximum hover wheel height, enter the chart at 1.02 x gross weight. (Example: If gross weight is 20,000 lb, multiply $20,000 \times 1.02 = 20,400$ lb).

EXAMPLE A

WANTED:

TORQUE REQUIRED TO HOVER OGE AND AT A 10-FOOT WHEEL HEIGHT

KNOWN:

FAT = 30°C
PRESSURE ALTITUDE = 2,000 FEET
GROSS WEIGHT = 19,500 POUNDS

METHOD:

ENTER HOVER CHART AT KNOWN FAT. MOVE RIGHT TO PRESSURE ALTITUDE, MOVE DOWN THROUGH GROSS WEIGHT LINES TO DESIRED GROSS WEIGHT. MOVE LEFT TO INDICATE TORQUE/ENGINE % (OGE) SCALE AND READ OGE HOVER TORQUE (94%). MOVE DOWN FROM INTERSECTION OF 10-FOOT HOVER LINE AND HORIZONTAL LINE TO READ TORQUE REQUIRED TO HOVER 10 FEET (80%).

EXAMPLE B

WANTED:

MAXIMUM GROSS WEIGHT TO HOVER OGE

KNOWN:

ATF = 1.0
FAT = 15°C
PRESSURE ALTITUDE = 8,000 FEET
MAXIMUM TORQUE AVAILABLE = 96%

METHOD:

ENTER INDICATED TORQUE/ENGINE (IGE) SCALE AT MAXIMUM TORQUE AVAILABLE (96%), MOVE UP TO OGE LINE. ENTER CHART AT KNOWN FAT (15°C). MOVE RIGHT TO PRESSURE ALTITUDE LINE (8,000 FT). MOVE DOWN FROM PRESSURE ALTITUDE LINE AND MOVE RIGHT FROM OGE LINE. WHERE LINES INTERSECT, READ MAXIMUM GROSS WEIGHT TO HOVER OGE.

Figure 7-4. Hover - Clean Configuration (Sheet 1 of 2)

HOVER

**CLEAN CONFIGURATION 100% RPM R
ZERO WIND**

HOVER
CLEAN
T700(2)

PRESSURE ALTITUDE ~ 1000 FT

NOTE

FOR LOW WIND CONDITIONS
AIRCRAFT SHOULD BE HEADED
INTO WIND. 3-5 KT CROSSWIND
OR TAILWIND MAY INCREASE
TORQUE REQUIRED BY UP TO
4% OVER ZERO WIND VALUES

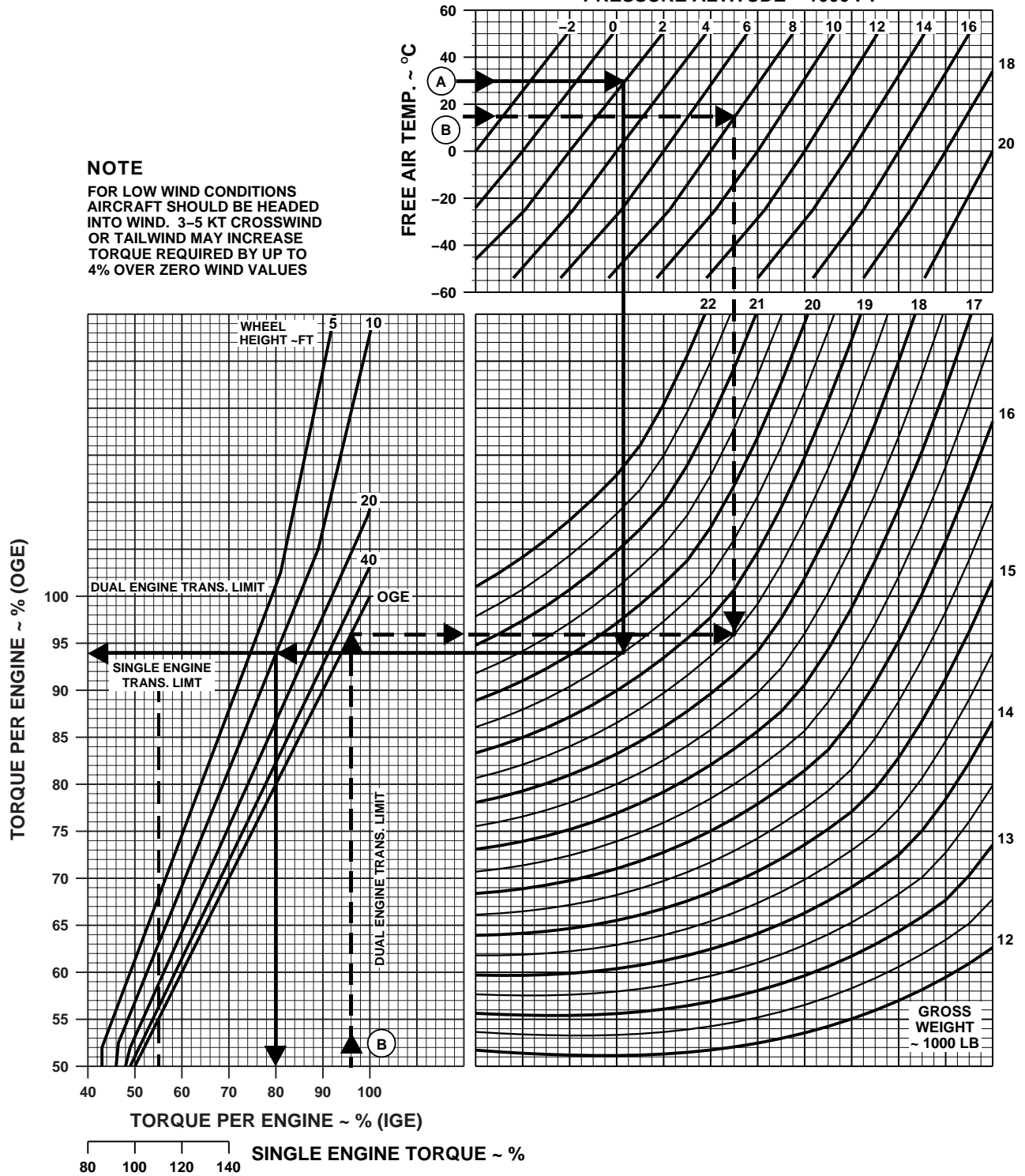

DATA BASIS: FLIGHT TEST

AA2143C
SA

Figure 7-4. Hover - Clean Configuration (Sheet 2 of 2)

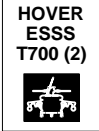

HOVER HIGH DRAG CONFIGURATION 100% RPM R ZERO WIND

PRESSURE ALTITUDE ~ 1000 FT

NOTE
FOR LOW WIND CONDITIONS
AIRCRAFT SHOULD BE HEADED
INTO WIND. 3-5 KT CROSSWIND
OR TAILWIND MAY INCREASE
TORQUE REQUIRED BY UP TO
4% OVER ZERO WIND VALUES

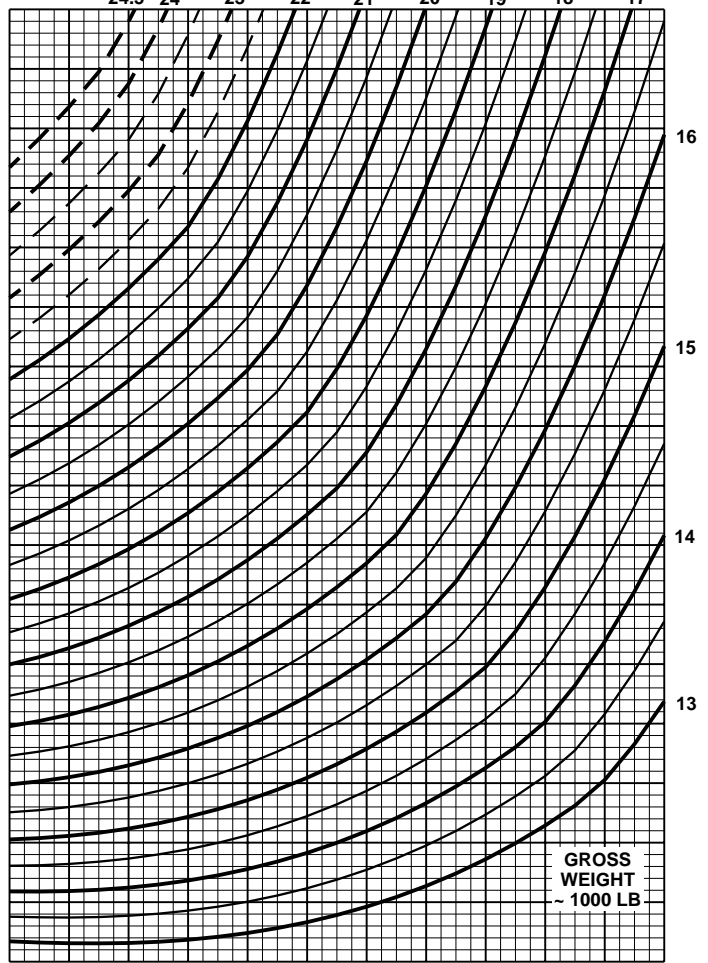
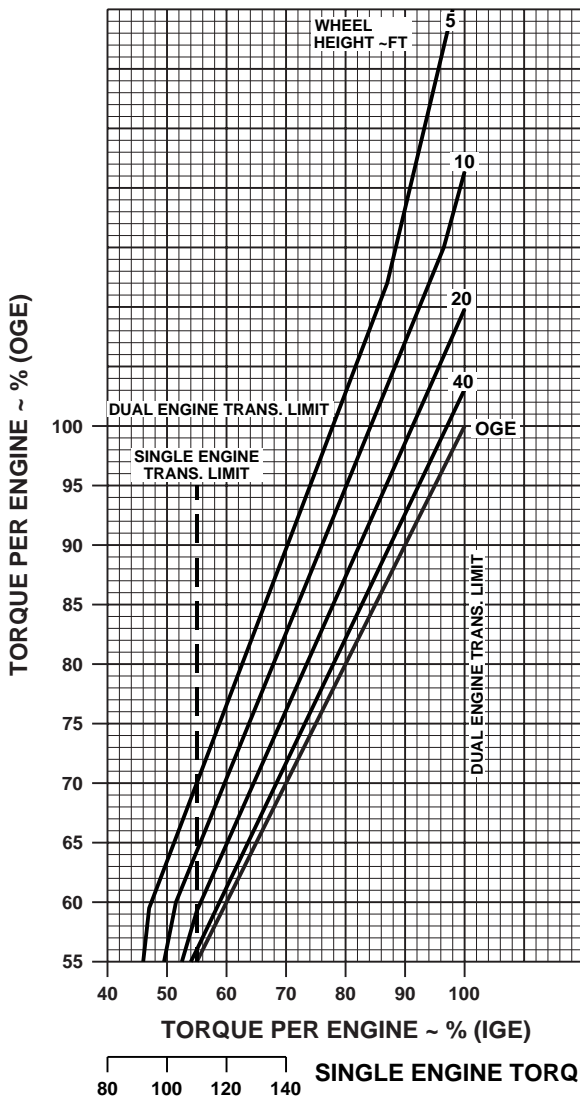
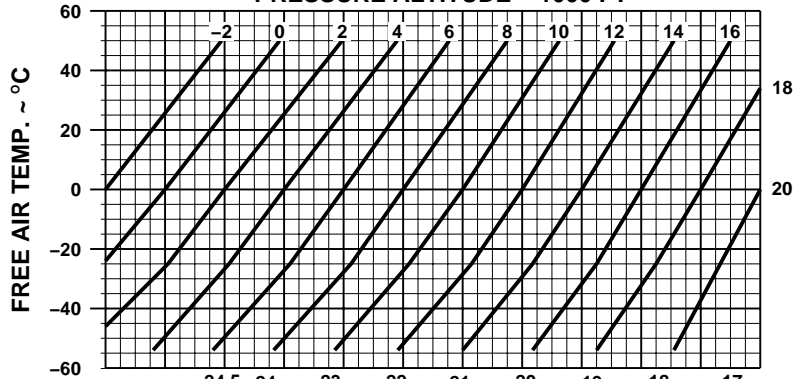

DATA BASIS: FLIGHT TEST

AA2144C
SA

Figure 7-5. Hover - High Drag

Section IV CRUISE

7.16 DESCRIPTION.

The cruise charts (Figures 7-6 through 7-28) present torque required and total fuel flow as a function of airspeed, altitude, temperature, and gross weight at 100% rotor speed. Scales for both true airspeed and indicated airspeed are presented. The baseline aircraft configuration for these charts was the "clean and high drag" configuration as defined in Section I. Each cruise chart also presents the change in torque (Δ TRQ) required for 10 sq. ft. of additional flat plate drag with a dashed line on a separate scale. This line is utilized to correct torque required for external loads as discussed in Section VI DRAG. Maximum level flight airspeed (Vh) is obtained at the intersection of gross weight arc and torque available - 30 minutes or the transmission torque limit, whichever is lower. Airspeeds that will produce maximum range, maximum endurance, and maximum rate of climb are also shown. Cruise charts are provided from sea level to 20,000 feet pressure altitude in units of 2,000 feet. Each figure number represents a different altitude. The charts provide cruise data for free air temperatures from -50° to $+60^{\circ}\text{C}$, in units of 10° . Charts with FAT's that exceed the engine ambient temperature limits by more than 10°C are deleted.

7.17 USE OF CHARTS.

The primary uses of the charts are illustrated by the examples of Figure 7-6. To use the charts, it is usually necessary to know the planned pressure altitude, estimated free air temperature, planned cruise speed, TAS, and gross weight. First, select the proper chart on the basis of pressure altitude and FAT. Enter the chart at the cruise airspeed, IAS, move horizontal and read TAS, move horizontal to the gross weight, move down and read torque required, and then move up and read associated fuel flow. Maximum performance conditions are determined by entering the chart where the maximum range line or the maximum endurance and rate of climb line intersects the gross weight line; then read airspeed, fuel flow, and torque required. Normally, sufficient accuracy can be obtained by selecting the chart nearest the planned cruising altitude and FAT or, more conservatively, by selecting the chart with the next higher altitude and FAT. If greater accuracy is required, interpolation between altitudes and/or temperatures is permissible. To be conservative, use the gross weight at the beginning of the cruise flight. For greater accuracy on long flights, however, it is preferable to determine cruise information for several flight segments to allow for the decreasing gross weight.

a. Airspeed. True and indicated airspeeds are presented at opposite sides of each chart. On any chart, indicated airspeed can be directly converted to true airspeed (or vice versa) by reading directly across the chart without regard for the other chart information. The level flight airspeed calibration for aircraft with wedge mounted pitot static probes (hard points only) was used to convert indicated to true airspeed.

b. Torque. Since pressure altitude and temperature are fixed for each chart, torque required varies according to gross weight and airspeed. The torque and torque limits shown on these charts are for dual-engine operation. The maximum torque available is presented on each chart as either the transmission torque limit or torque available - 30 minute for both ATF-1.0 and 0.9 values. The maximum torque available for aircraft with an ATF value between these shall be interpolated. The continuous torque available values shown represent the minimum torque available for ATF's of 0.95 or greater. For ATF's less than 0.95 maximum continuous torque available may be slightly reduced. Higher torque than that represented by these lines may be used if it is available without exceeding the limitations presented in Chapter 5. An increase or decrease in torque required because of a drag area change is calculated by adding or subtracting the change in torque from the torque on the curve, and then reading the new fuel flow total.

c. Fuel Flow. Fuel flow scales are provided opposite the torque scales. On any chart, torque may be converted directly to fuel flow without regard to other chart information. Data shown in this section is for two-engine operation. For one-engine fuel flow, refer to Section VIII FUEL FLOW.

(1) With bleed-air extracted, fuel flow increases:

(a) Engine anti-ice on -About 60 lbs/hr Example:
(760 lbs/hr + 60 lbs/hr = 820 lbs/hr.)

(b) Heater on - About 20 lbs/hr.

(c) Both on - About 80 lbs/hr.

(2) When the cruise IR suppressors are removed or hover IR suppressor system is installed and operating in the benign mode (exhaust baffles removed), the dual-engine fuel flow will decrease about 16 lbs/hr.

d. Maximum Range. The maximum range lines (MAX RANGE) indicate the combinations of gross weight and

airspeed that will produce the greatest flight range per pound of fuel under zero wind conditions. When maximum range airspeed line is above the maximum torque available, the resulting maximum airspeed should be used for maximum range. A method of estimating maximum range speed in winds is to increase IAS by 2.5 knots per each 10 knots of effective headwind (which reduces flight time and minimizes loss in range) and decrease IAS by 2.5 knots per 10 knots of effective tailwind for economy.

e. Maximum Endurance and Rate of Climb. The maximum endurance and rate of climb lines (MAX END and R/C) indicate the combinations of gross weight and airspeed that will produce the maximum endurance and the maximum rate of climb. The torque required for level flight at this condition is a minimum, providing a minimum fuel flow (maximum endurance) and a maximum torque change available for climb (maximum rate of climb).

f. Change in Frontal Area. Since the cruise information is given for the "clean configuration," adjustments to torque should be made when operating with external sling loads or aircraft external configuration changes. To determine the change in torque, first obtain the appropriate multiplying factor from the drag load chart (Figure 7-30), then enter the cruise chart at the planned cruise speed TAS, move right to the broken Δ TRQ line, and move up and read Δ TRQ. Multiply Δ TRQ by the multiplying factor to obtain change in torque, then add or subtract change in torque from torque required for the primary mission configuration. Enter the cruise chart at resulting torque required, move up, and read fuel flow. If the resulting torque required exceeds the governing torque limit, the torque required must be reduced to the limit. The resulting reduction in airspeed may be found by subtracting the change in torque from the limit torque; then enter the cruise chart at the reduced torque, and move up to the gross weight. Move left or right to read TAS or IAS. The engine torque setting for maximum range obtained from the clean configuration cruise chart will gener-

ally result in cruise at best range airspeed for the higher drag configuration. To determine the approximate airspeed for maximum range for alternative or external load configurations, reduce the value from the cruise chart by 6 knots for each 10 square foot increase in drag area, ΔF . For example, if both cabin doors are open the ΔF increases 6 ft^2 and the maximum range airspeed would be reduced by approximately 4 knots ($6 \text{ Kts}/10 \text{ ft}^2 \times 6 \text{ ft}^2 = 3.6 \text{ Kts}$).

g. Additional Uses. The low speed end of the cruise chart (below 40 knots) is shown primarily to familiarize you with the low speed power requirements of the helicopter. It shows the power margin available for climb or acceleration during maneuvers, such as NOE flight. At zero airspeed, the torque represents the torque required to hover out of ground effect. In general, mission planning for low speed flight should be based on hover out of ground effect.

7.18 SINGLE-ENGINE.

a. The minimum or maximum single-engine speeds can be determined by using a combination of the 700 torque available and cruise charts. To calculate single-engine speeds, first determine the torque available from Section II at the TGT limit desired and divide by 2. (Example: $90\% \text{ TRQ} \div 2 = 45\% \text{ TRQ}$.)

b. Select the appropriate cruise chart for the desired flight condition and enter the torque scale with the torque value derived above. Move up to the intersection of torque available and the mission gross weight arc, and read across for minimum single-engine airspeed. Move up to the second intersection of torque and weight, and read across to determine the maximum single-engine speed. If no intersections occur, there is no single-engine level flight capability for the conditions. Single-engine fuel flow at the desired 10 minute, 30 minute, continuous conditions may be obtained by doubling the torque required from the cruise chart and referring to Figure 7-34.

CRUISE EXAMPLE CLEAN CONFIGURATION 100% RPM R

EXAMPLE

FAT: 30°C ALT: 6,000 FT
TOTAL FUEL FLOW 100 LB/HR

WANTED:

- A. CRUISE CONDITIONS FOR MAXIMUM RANGE
- B. CONDITIONS FOR MAXIMUM ENDURANCE
- C. MAXIMUM AIRSPEED IN LEVEL FLIGHT
- D. DETERMINE TORQUE AND FUEL FLOW REQUIRED TO CRUISE AT THE CONDITIONS OF EXAMPLE A WITH CABIN DOORS OPEN

KNOWN:

FAT = + 30°C
PRESSURE ALTITUDE = 6000 FT
GW = 17000 LBS
ATF = 0.95

METHOD:

- A. TURN TO CRUISE CHARTS NEAREST KNOWN FLIGHT CONDITIONS, AT INTERSECTION OF MAX RANGE LINE AND KNOWN VALUE OF GROSS WEIGHT:
 - MOVE LEFT, READ TAS = 135 KTS
 - MOVE RIGHT, READ IAS = 119 KTS
 - MOVE DOWN, READ TORQUE = 62% TRQ
 - MOVE UP, READ TOTAL FUEL FLOW = 900 LBS / HR
- B. AT INTERSECTION OF MAX END. / AND R / C LINE AND KNOWN VALUE OF GROSS WEIGHT:
 - MOVE LEFT, READ TAS = 82 KTS
 - MOVE RIGHT, READ IAS = 67 KTS
 - MOVE DOWN, READ TORQUE = 41% TRQ
 - MOVE UP, READ TOTAL FUEL FLOW = 700 LBS / HR
- C. AT INTERSECTION OF 30-MINUTE TORQUE AVAILABLE AS INTERPOLATED FOR THE ATF VALUE AT THE KNOWN GROSS WEIGHT:
 - MOVE LEFT, READ MAXIMUM TAS = 153 KTS
 - MOVE RIGHT, READ MAXIMUM IAS = 135 KTS
 - MOVE DOWN, READ MAXIMUM TORQUE = 82% TRQ
 - MOVE UP, READ TOTAL FUEL FLOW = 1125 LBS / HR
- D. ENTER Δ TRQ% PER 10 SQ FT SCALE AT 135 KTAS
 - MOVE UP READ Δ TRQ = 8.0%
 - TURN TO DRAG TABLE IN SECTION VII
 - NOTE CABIN DOORS OPEN = 6.0 SQ FT Δ F
 - AND HAS A DRAG MULTIPLYING FACTOR VALUE OF 0.60, CALCULATE TOTAL TORQUE REQUIRED:

$62\% + (0.6 \times 8.0\%) = 66.8\%$ TRQ

READ FUEL FLOW AT-TOTAL TORQUE = 950 LBS / HR

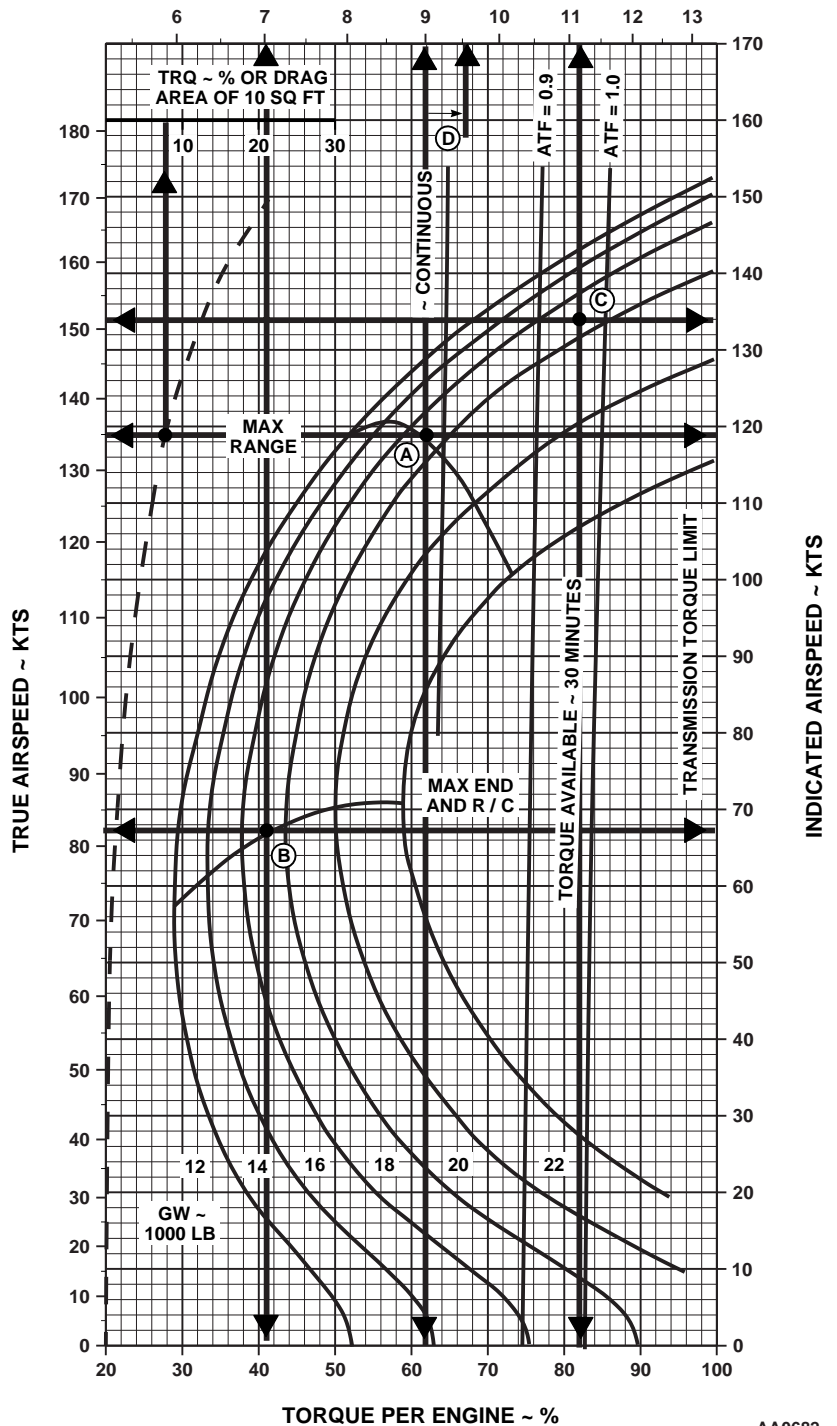

AA0682
SA

Figure 7-6. Sample Cruise Chart - Clean

CRUISE

CLEAN CONFIGURATION

PRESS ALT: 0 FT

CRUISE
0 FT
T700 (2)

-50°C

-40°C

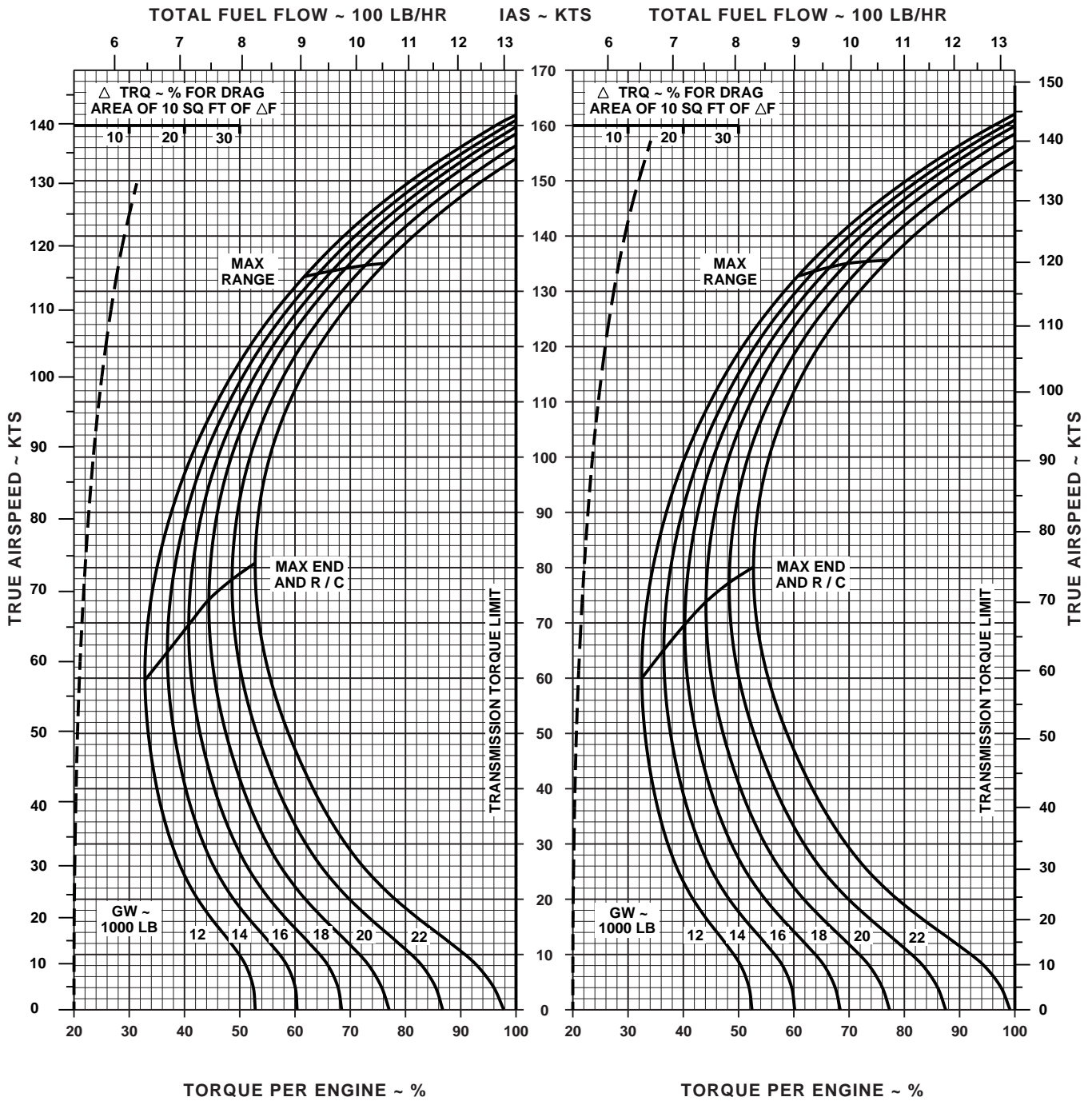

DATA BASE: FLIGHT TEST

AA0414
SA

Figure 7-7. Cruise - Pressure Altitude Sea Level (Sheet 1 of 6)

CRUISE CLEAN CONFIGURATION PRESS ALT: 0 FT

CRUISE
0 FT
T700 (2)

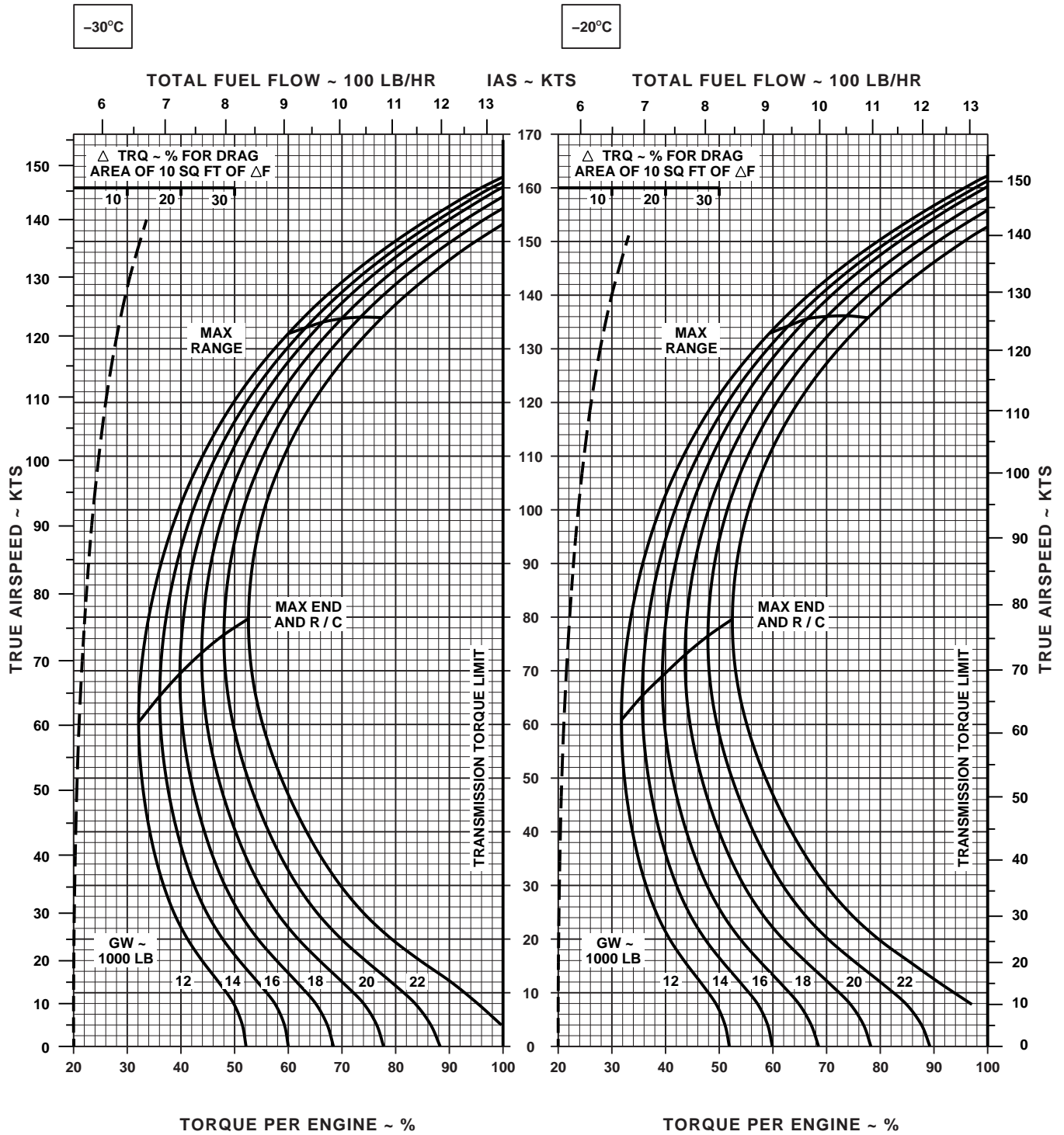

DATA BASE: FLIGHT TEST

AA0413
SA

Figure 7-7. Cruise - Pressure Altitude Sea Level (Sheet 2 of 6)

CRUISE

CLEAN CONFIGURATION

PRESS ALT: 0 FT

CRUISE
0 FT
T700 (2)

-10°C

0°C

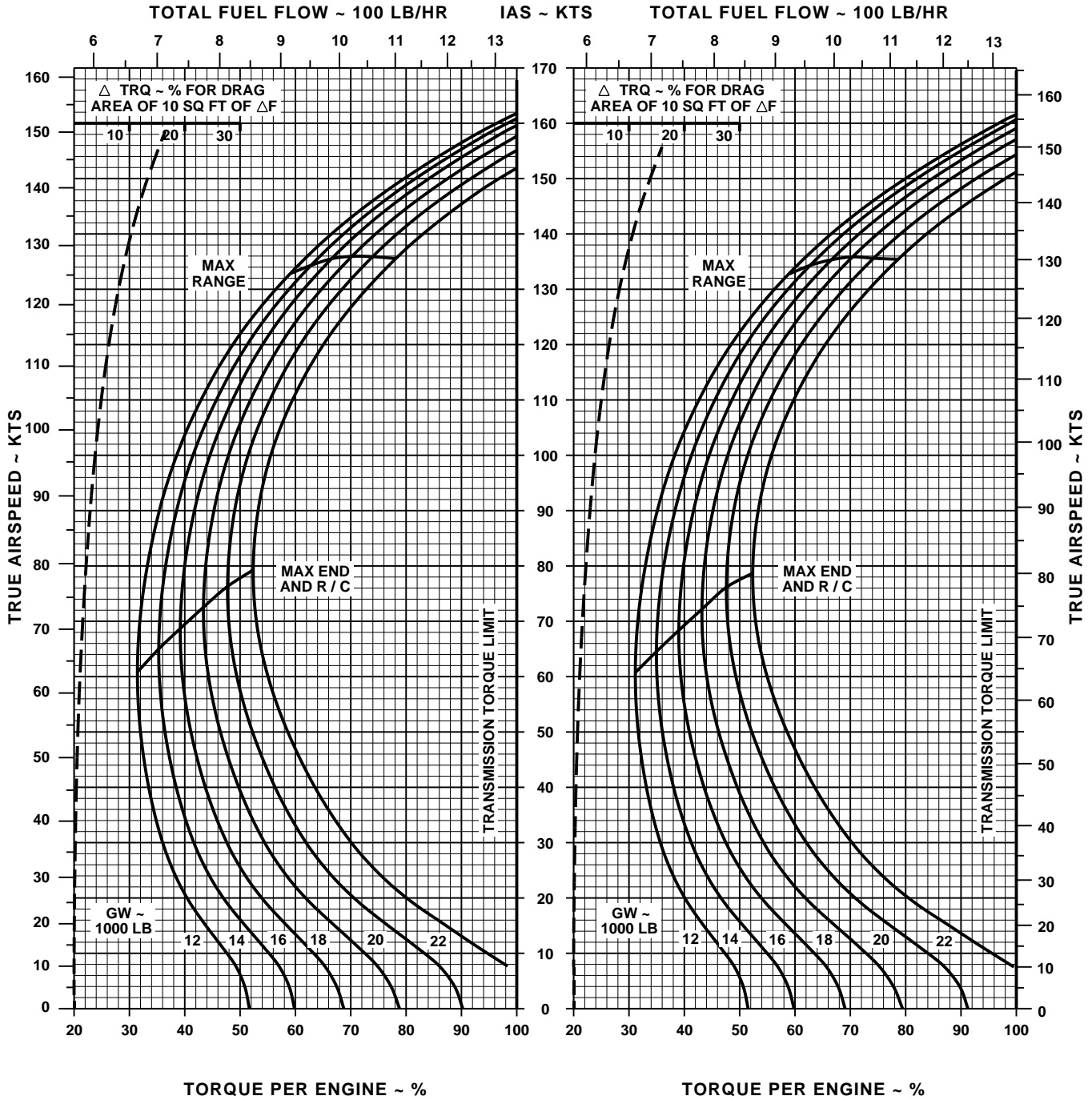

DATA BASE: FLIGHT TEST

AA0412
SA

Figure 7-7. Cruise - Pressure Altitude Sea Level (Sheet 3 of 6)

CRUISE

CLEAN CONFIGURATION

PRESS ALT: 0 FT

CRUISE
0 FT
T700 (2)

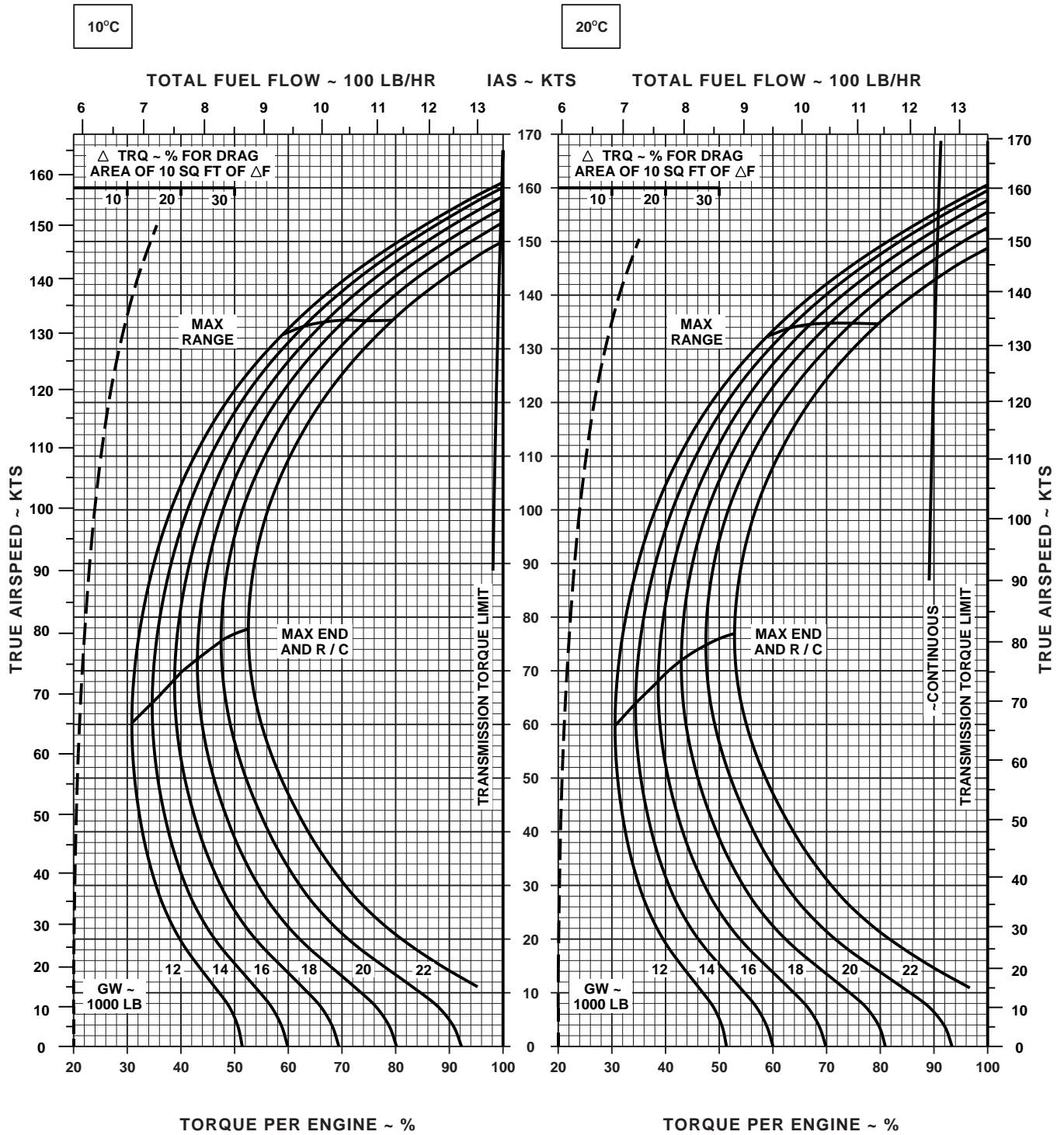

DATA BASE: FLIGHT TEST

AA0415
SA

Figure 7-7. Cruise - Pressure Altitude Sea Level (Sheet 4 of 6)

CRUISE

CLEAN CONFIGURATION

PRESS ALT: 0 FT

CRUISE
0 FT
T700 (2)

30°C

40°C

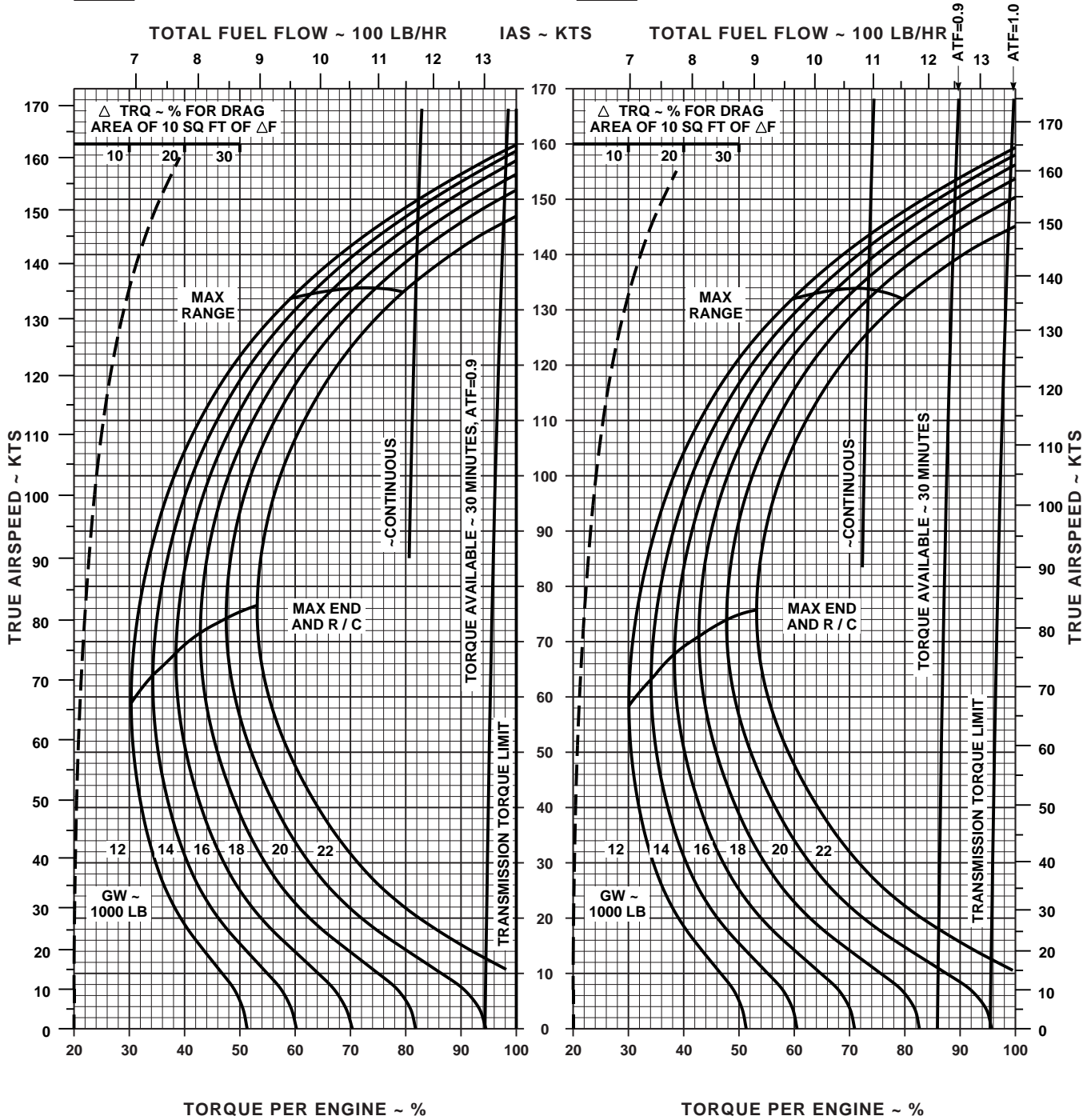

DATA BASE: FLIGHT TEST

AA0416
SA

Figure 7-7. Cruise - Pressure Altitude Sea Level (Sheet 5 of 6)

CRUISE

CLEAN CONFIGURATION

PRESS ALT: 0 FT

CRUISE
0 FT
T700 (2)

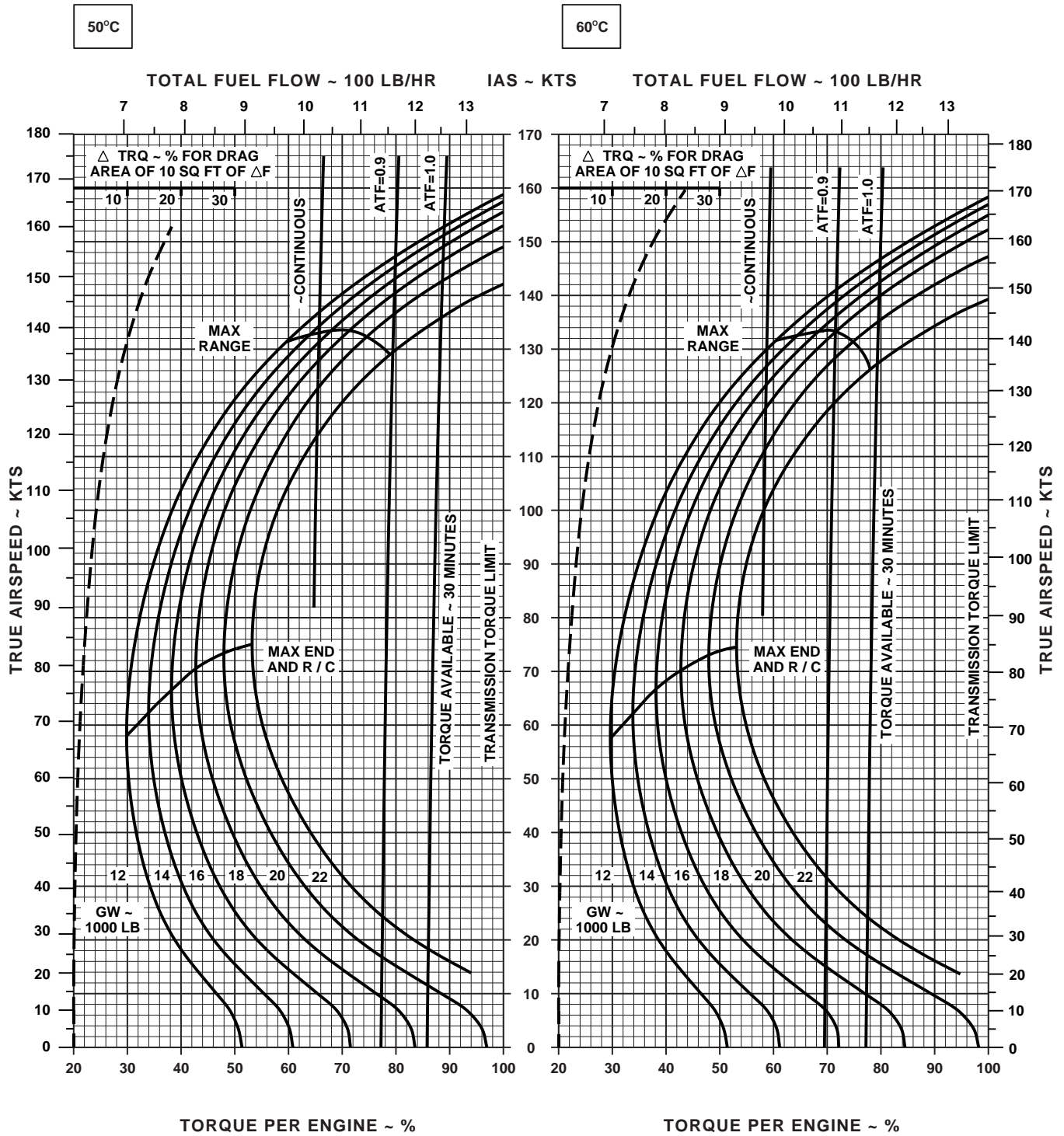

DATA BASE: FLIGHT TEST

AA0417
SA

Figure 7-7. Cruise - Pressure Altitude Sea Level (Sheet 6 of 6)

CRUISE

PRESS ALT: 0 FT

CRUISE
0 FT
T700 (2)



-50°C

-40°C

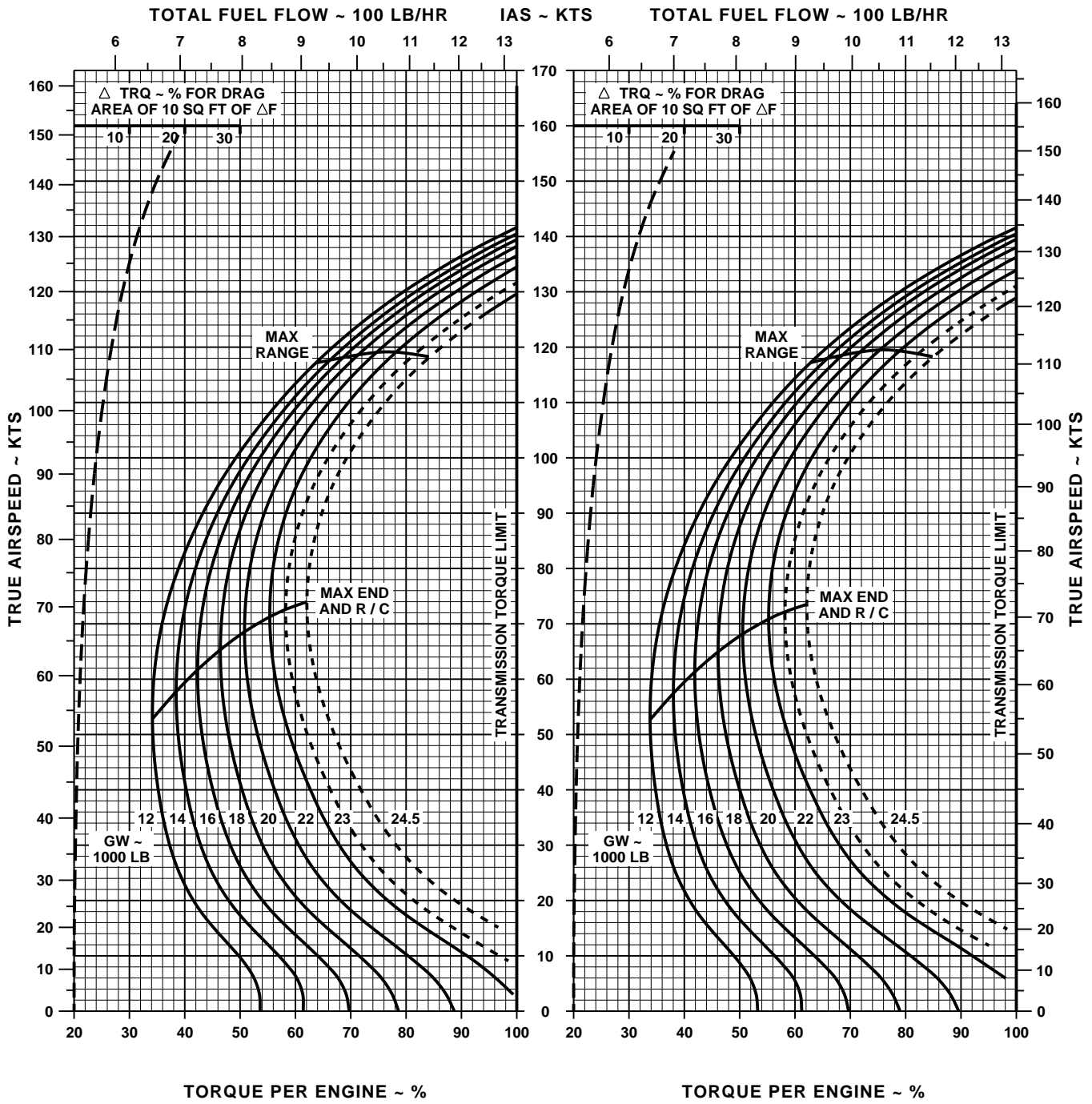

DATA BASE: FLIGHT TEST

AA0534
SA

Figure 7-8. Cruise High Drag - Pressure Altitude Sea Level (Sheet 1 of 6)

CRUISE

PRESS ALT: 0 FT

CRUISE
0 FT
T700 (2)



-30°C

-20°C

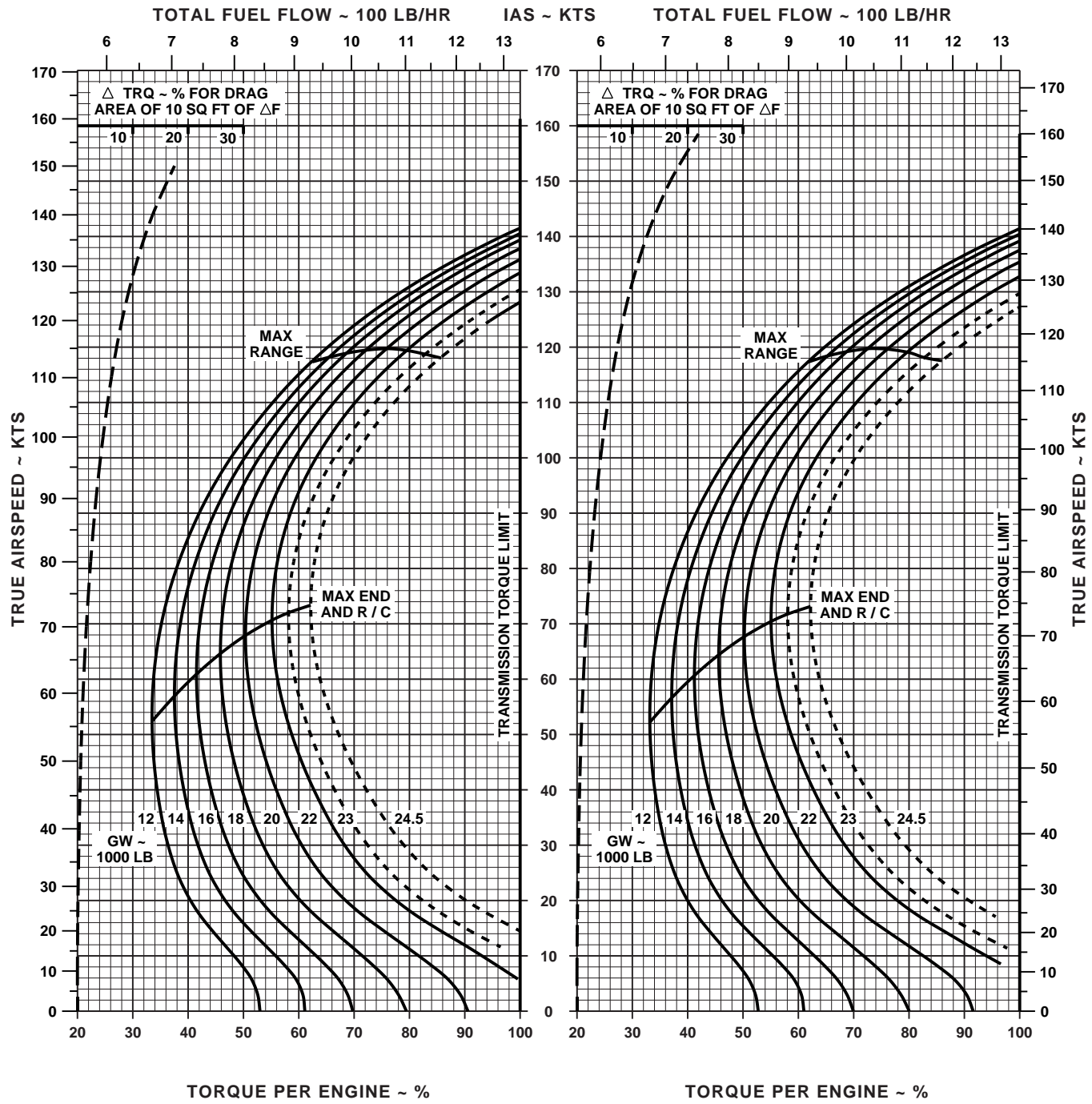

DATA BASE: FLIGHT TEST

AA0535
SA

Figure 7-8. Cruise High Drag - Pressure Altitude Sea Level (Sheet 2 of 6)

CRUISE

PRESS ALT: 0 FT

CRUISE
0 FT
T700 (2)



-10°C

0°C

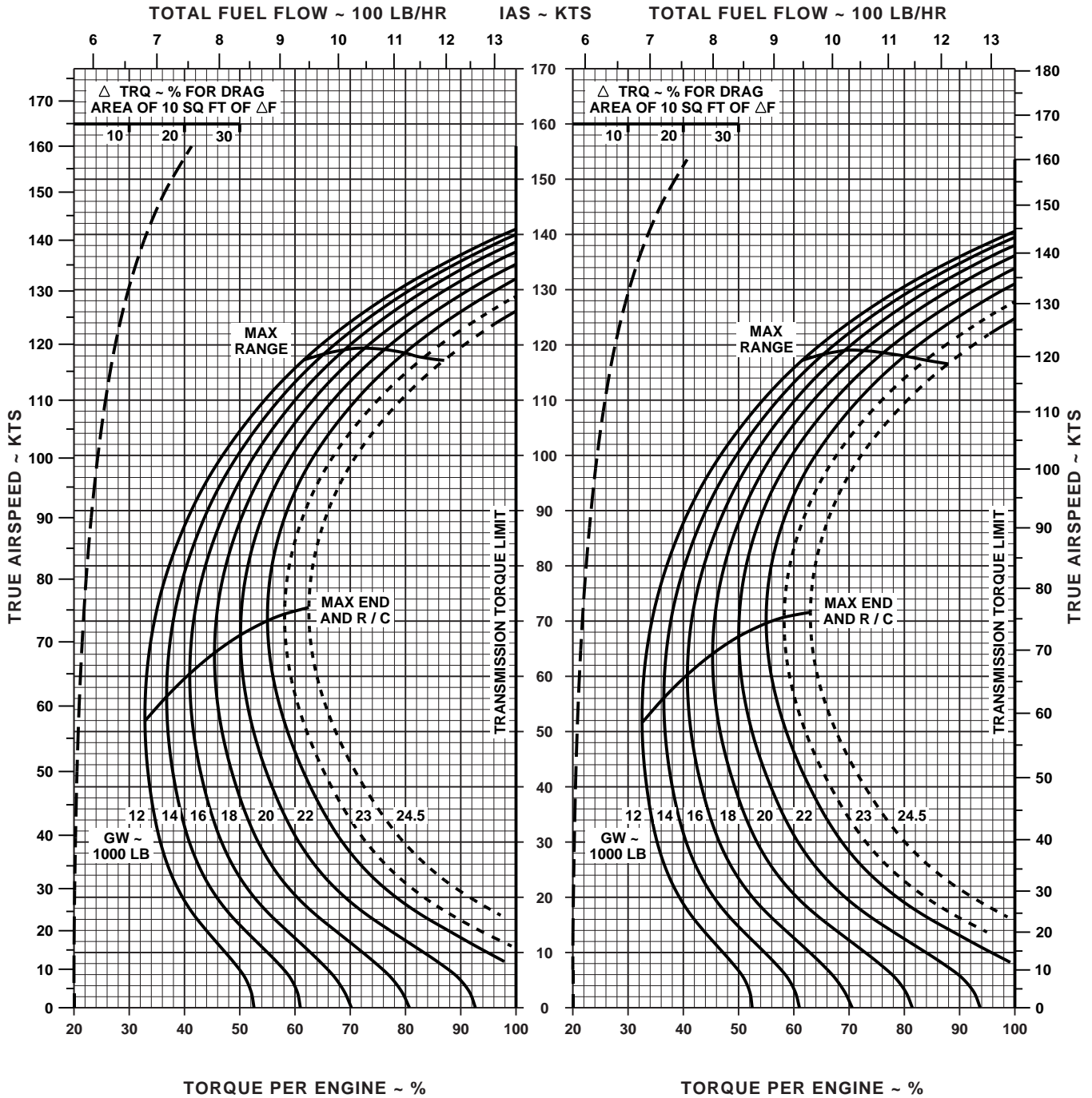

DATA BASE: FLIGHT TEST

AA0536
SA

Figure 7-8. Cruise High Drag - Pressure Altitude Sea Level (Sheet 3 of 6)

CRUISE

PRESS ALT: 0 FT

CRUISE
0 FT
T700 (2)



10°C

20°C

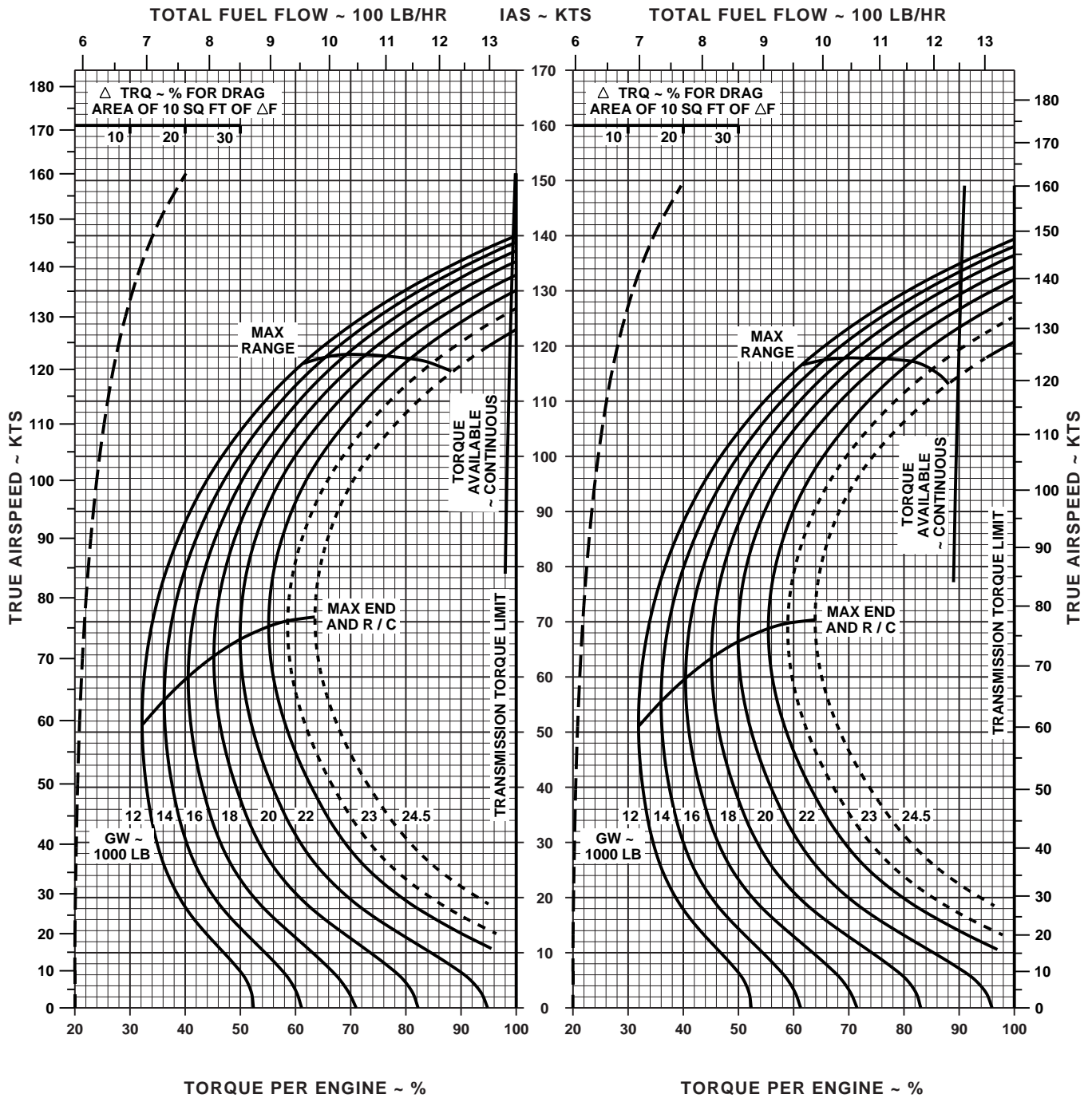

DATA BASE: FLIGHT TEST

AA0537
SA

Figure 7-8. Cruise High Drag - Pressure Altitude Sea Level (Sheet 4 of 6)

CRUISE

PRESS ALT: 0 FT

CRUISE
0 FT
T700 (2)



30°C

40°C

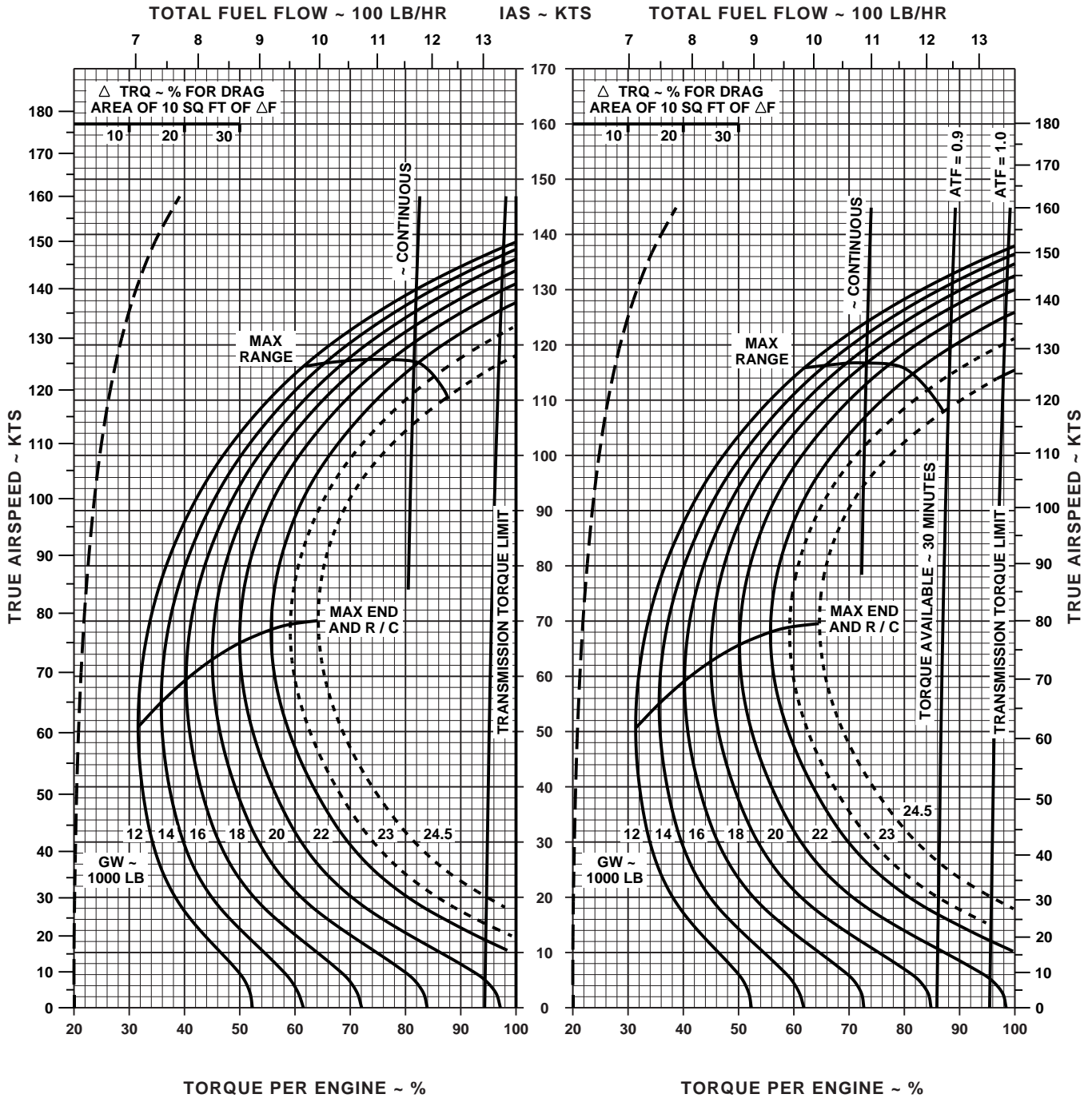

DATA BASE: FLIGHT TEST

AA0538
SA

Figure 7-8. Cruise High Drag - Pressure Altitude Sea Level (Sheet 5 of 6)

CRUISE

PRESS ALT: 0 FT

CRUISE
0 FT
T700 (2)



50°C

60°C

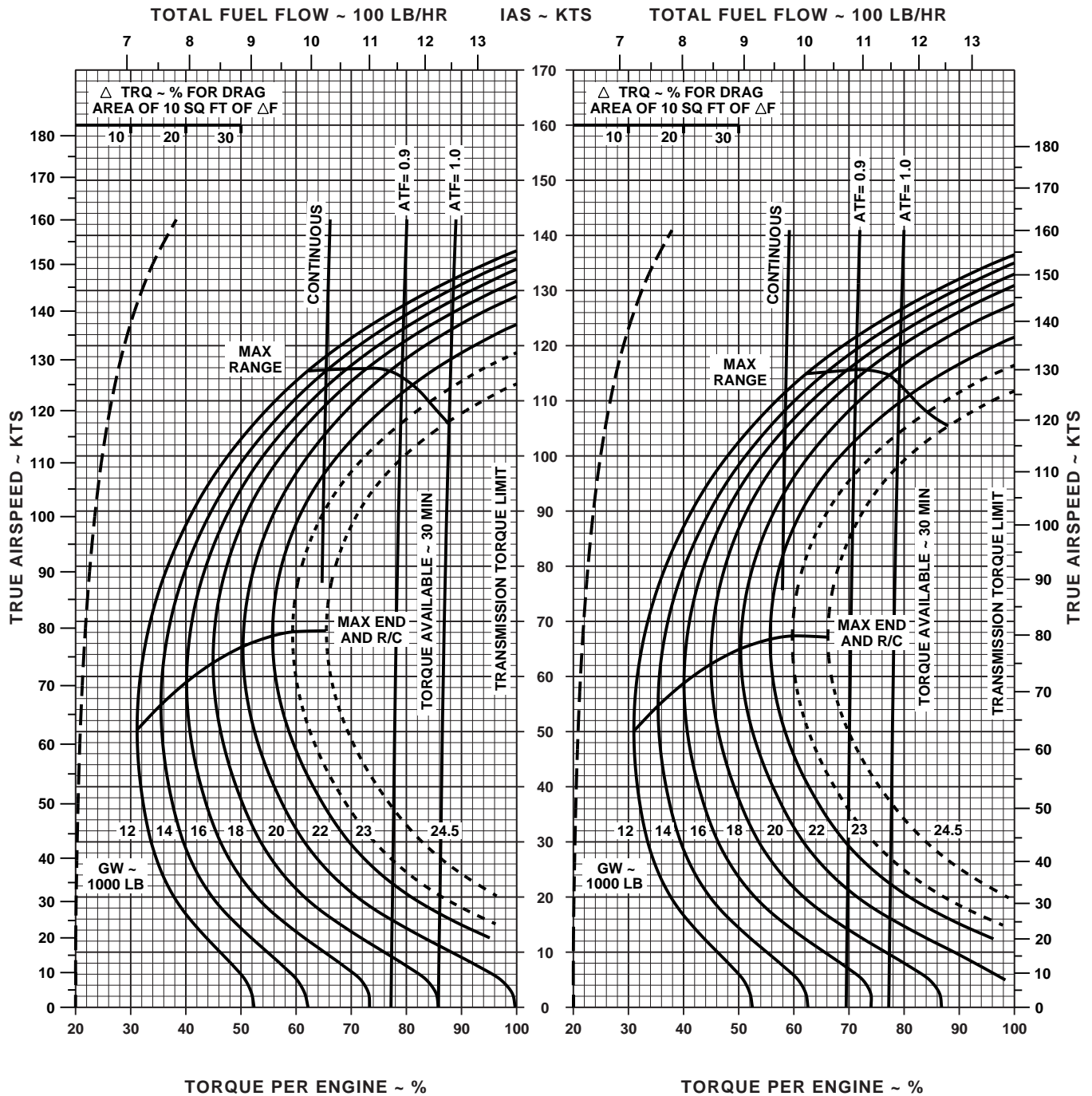

DATA BASE: FLIGHT TEST

AA0539
SA

Figure 7-8. Cruise High Drag - Pressure Altitude Sea Level (Sheet 6 of 6)

CRUISE

CLEAN CONFIGURATION

PRESS ALT: 2000 FT

CRUISE
2000 FT
T700 (2)

-50°C

-40°C

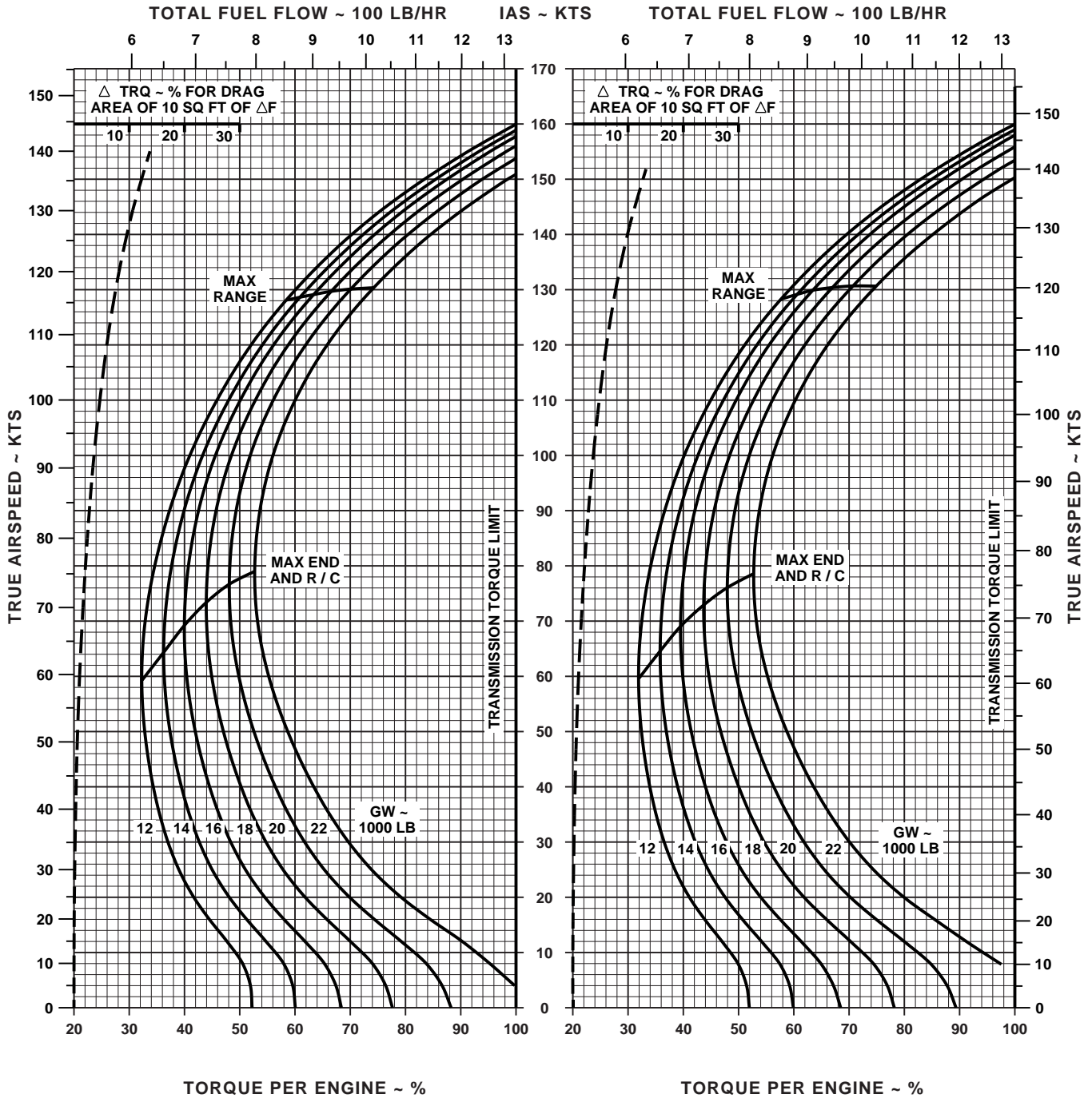

DATA BASE: FLIGHT TEST

AA0449
SA

Figure 7-9. Cruise - Pressure Altitude 2,000 Feet (Sheet 1 of 6)

CRUISE

CLEAN CONFIGURATION

PRESS ALT: 2000 FT

CRUISE
2000 FT
T700 (2)

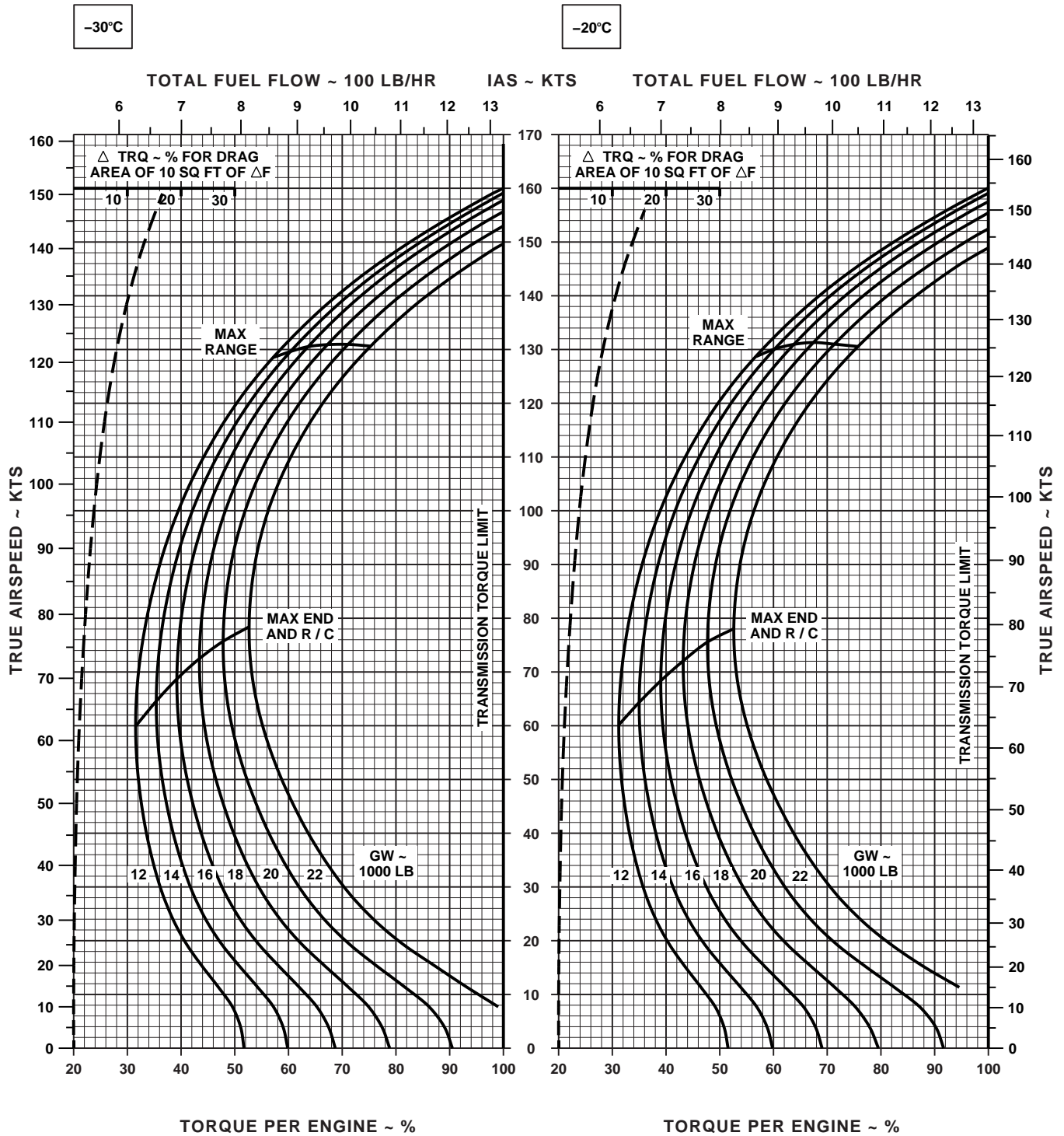

DATA BASE: FLIGHT TEST

AA0448
SA

Figure 7-9. Cruise - Pressure Altitude 2,000 Feet (Sheet 2 of 6)

CRUISE

CLEAN CONFIGURATION

PRESS ALT: 2000 FT

CRUISE
2000 FT
T700 (2)

-10°C

0°C

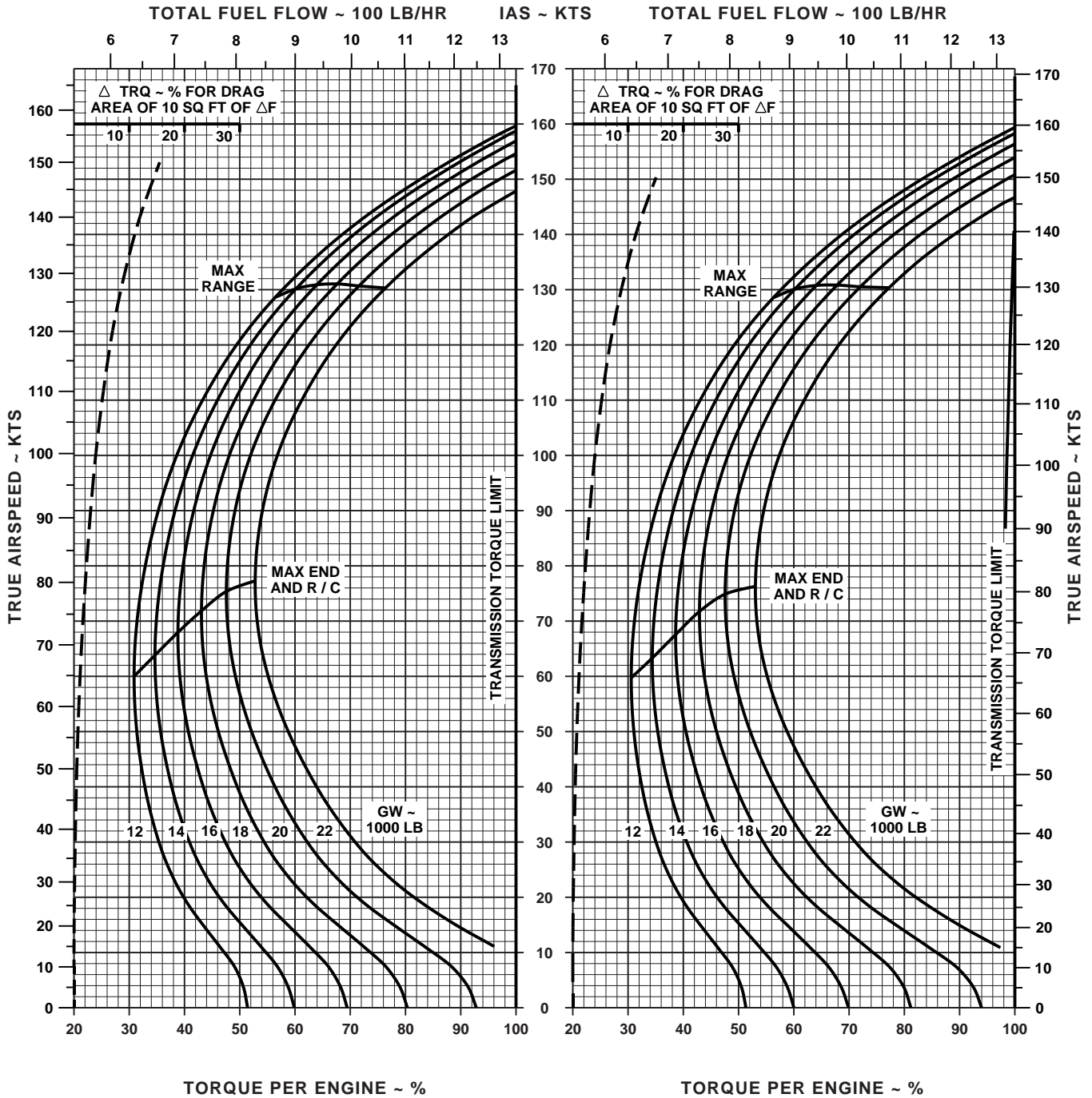

DATA BASE: FLIGHT TEST

AA0447
SA

Figure 7-9. Cruise - Pressure Altitude 2,000 Feet (Sheet 3 of 6)

CRUISE

CLEAN CONFIGURATION

PRESS ALT: 2000 FT

CRUISE
2000 FT
T700 (2)

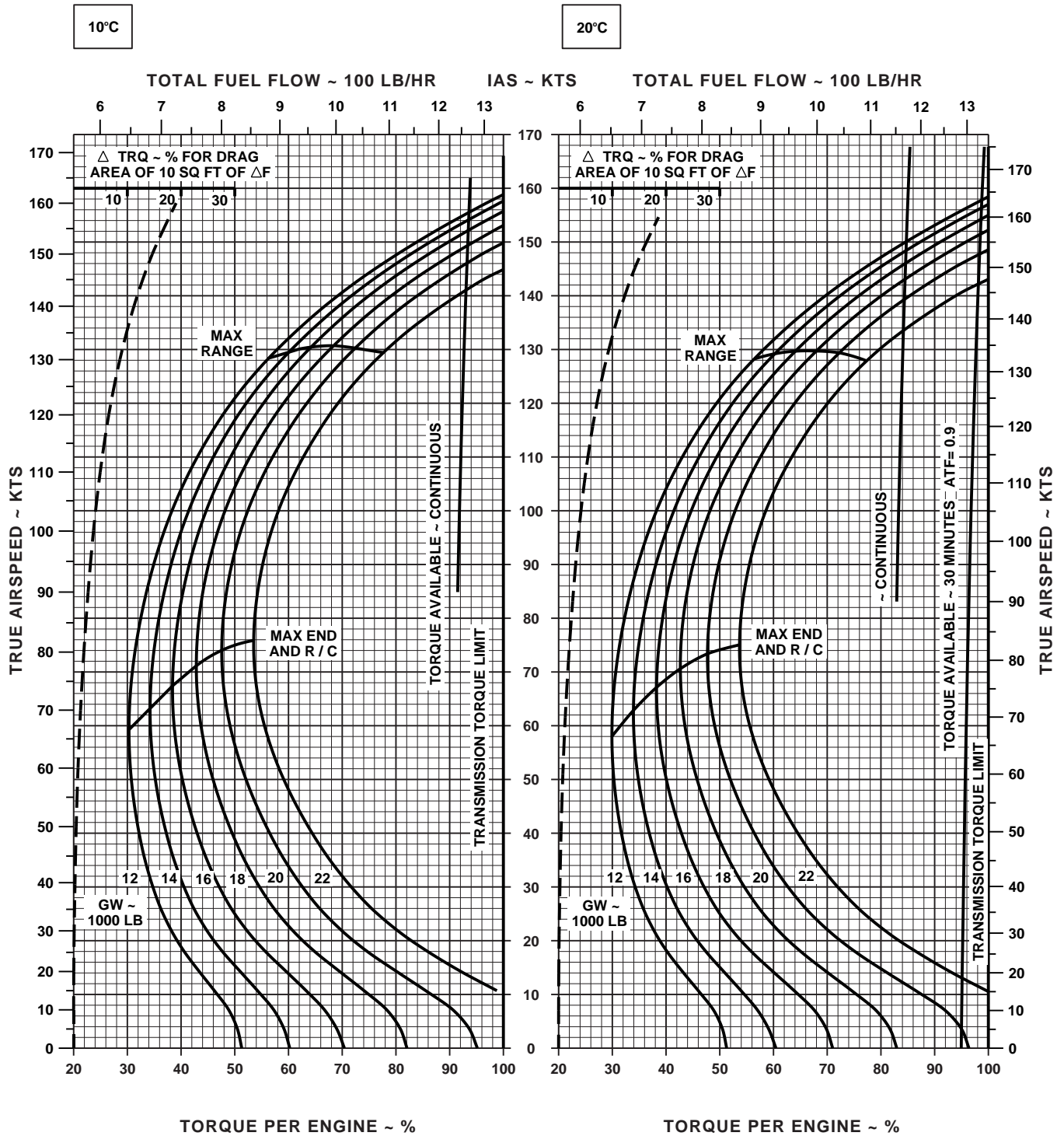

DATA BASE: FLIGHT TEST

AA0450
SA

Figure 7-9. Cruise - Pressure Altitude 2,000 Feet (Sheet 4 of 6)

CRUISE

CLEAN CONFIGURATION

PRESS ALT: 2000 FT

CRUISE
2000 FT
T700 (2)

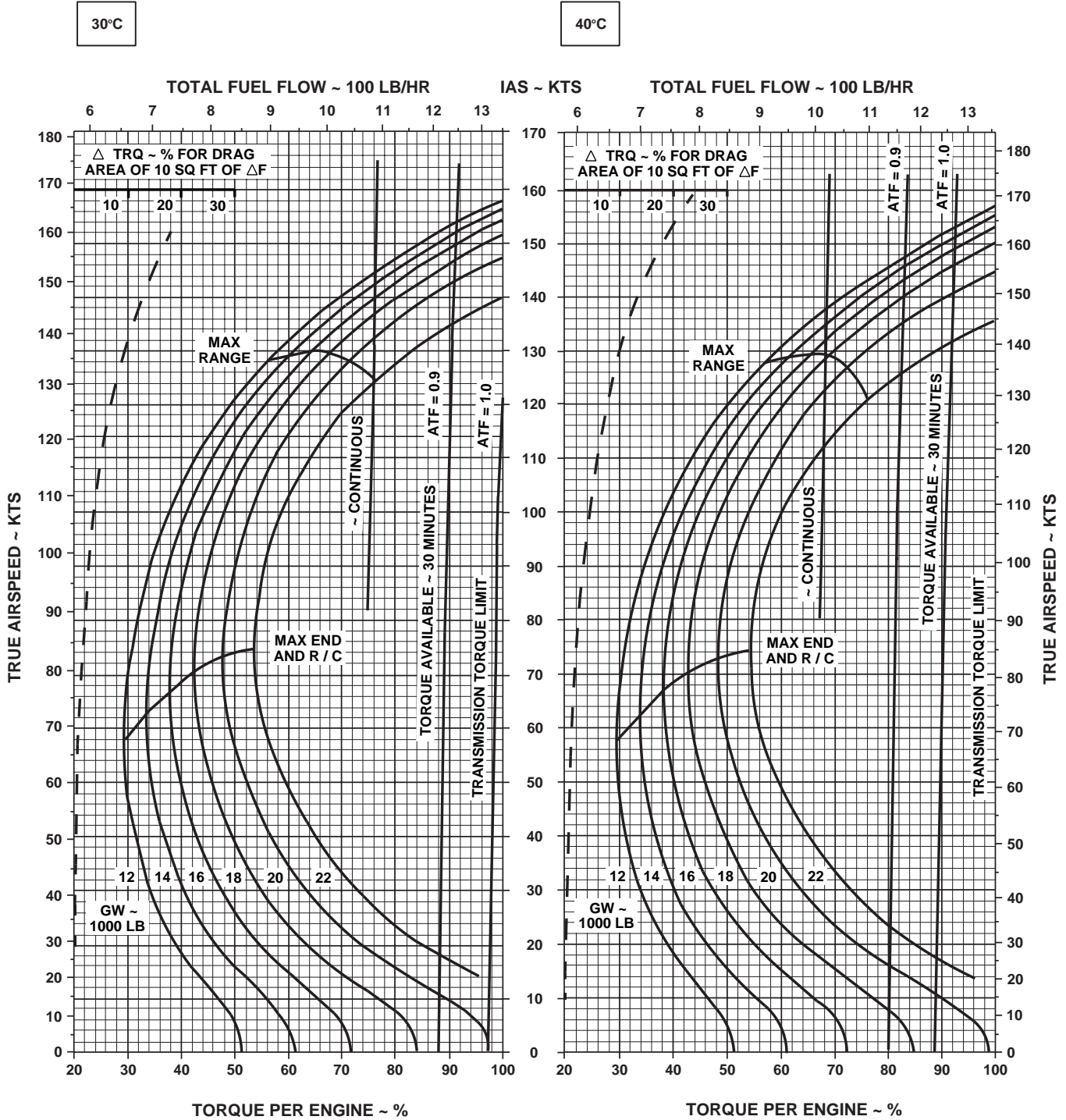

Figure 7-9. Cruise - Pressure Altitude 2,000 Feet (Sheet 5 of 6)

AA0451
SA

CRUISE

CLEAN CONFIGURATION

PRESS ALT: 2000 FT

CRUISE
2000 FT
T700 (2)

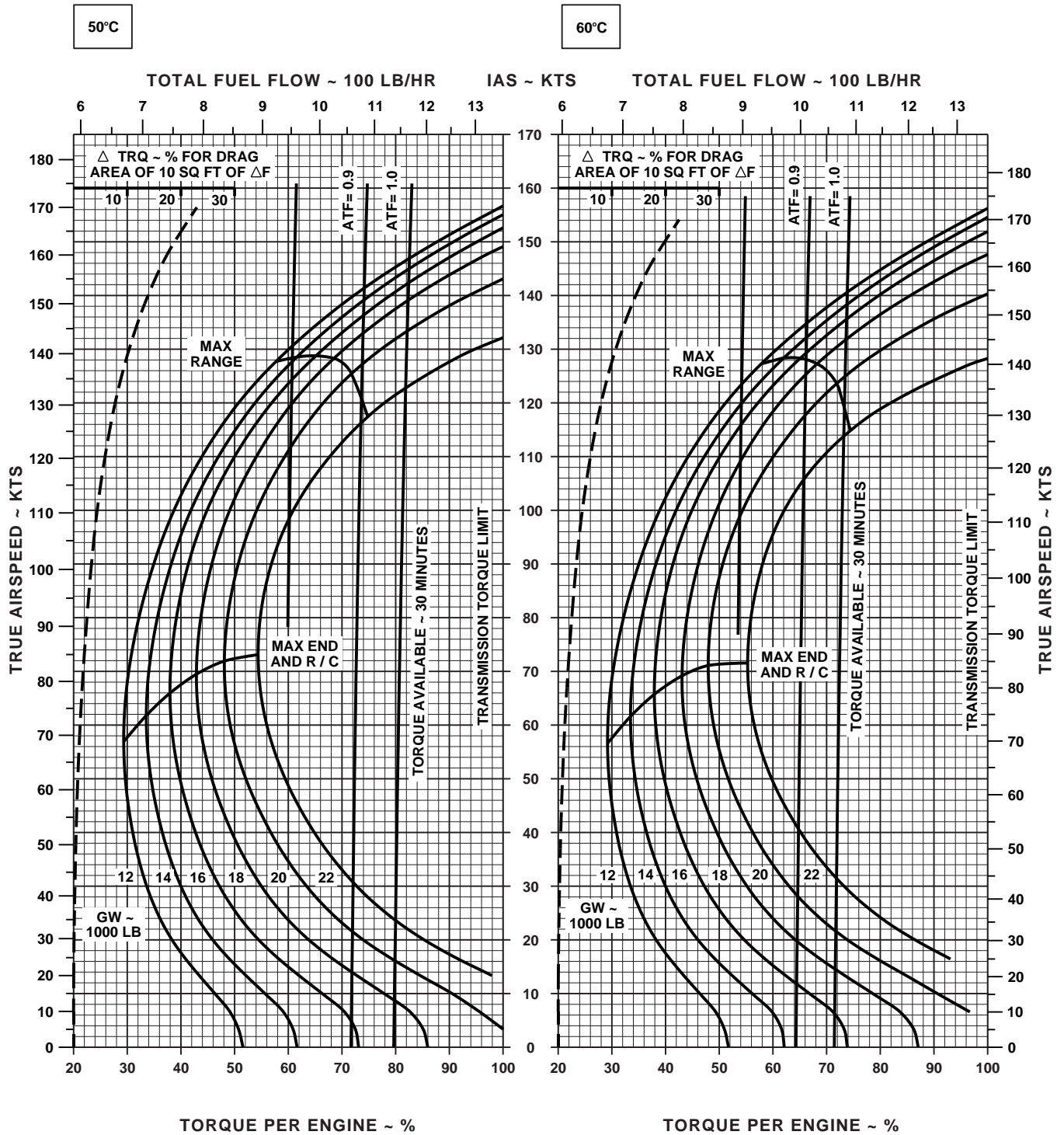

DATA BASE: FLIGHT TEST

AA0452
SA

Figure 7-9. Cruise - Pressure Altitude 2,000 Feet (Sheet 6 of 6)

CRUISE

PRESS ALT: 2000 FT

CRUISE
2000 FT
T700 (2)



-50°C

-40°C

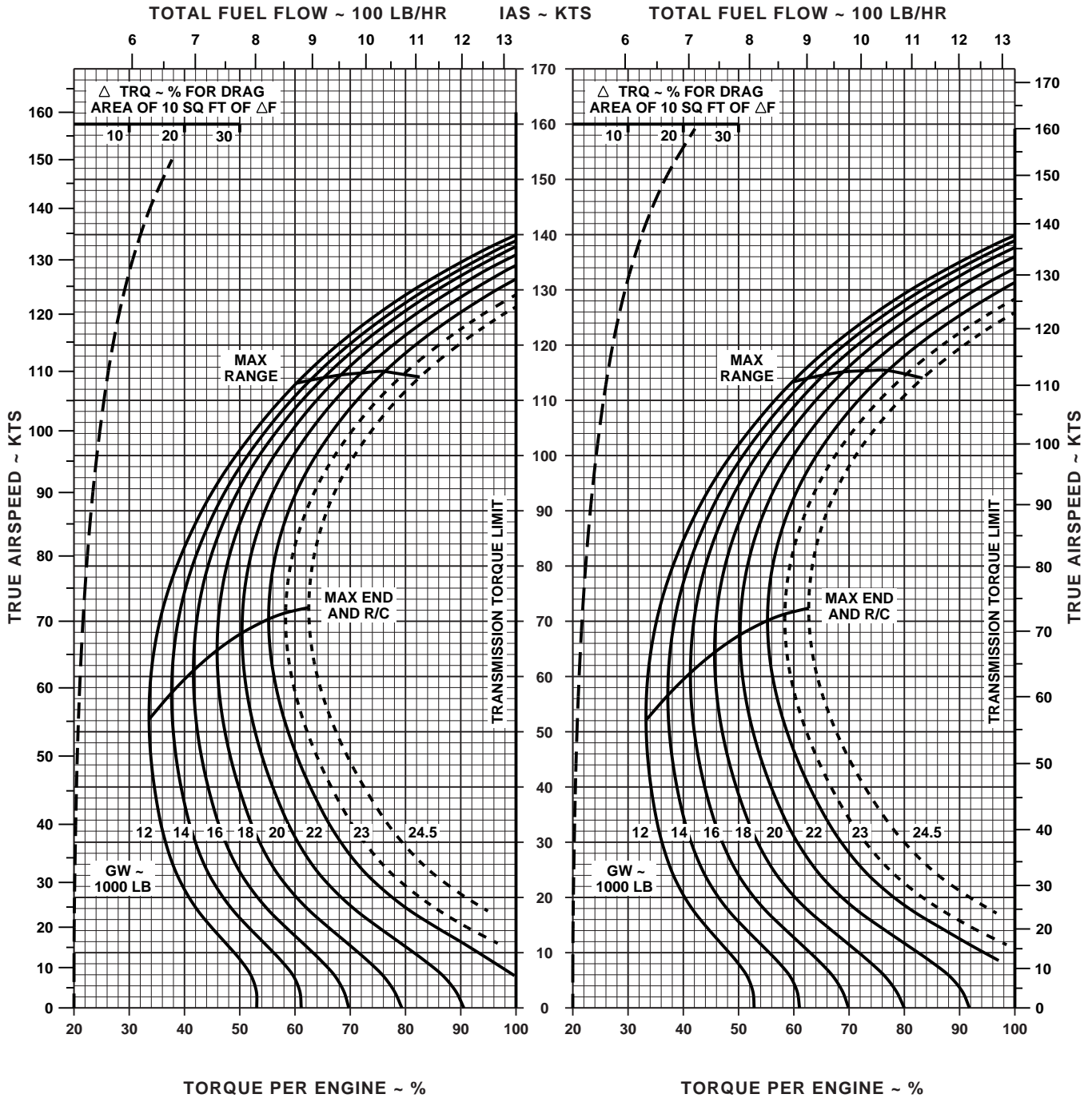

DATA BASE: FLIGHT TEST

AA0540
SA

Figure 7-10. Cruise High Drag - Pressure Altitude 2,000 Feet (Sheet 1 of 6)

CRUISE

PRESS ALT: 2000 FT

CRUISE
2000 FT
T700 (2)



-30°C

-20°C

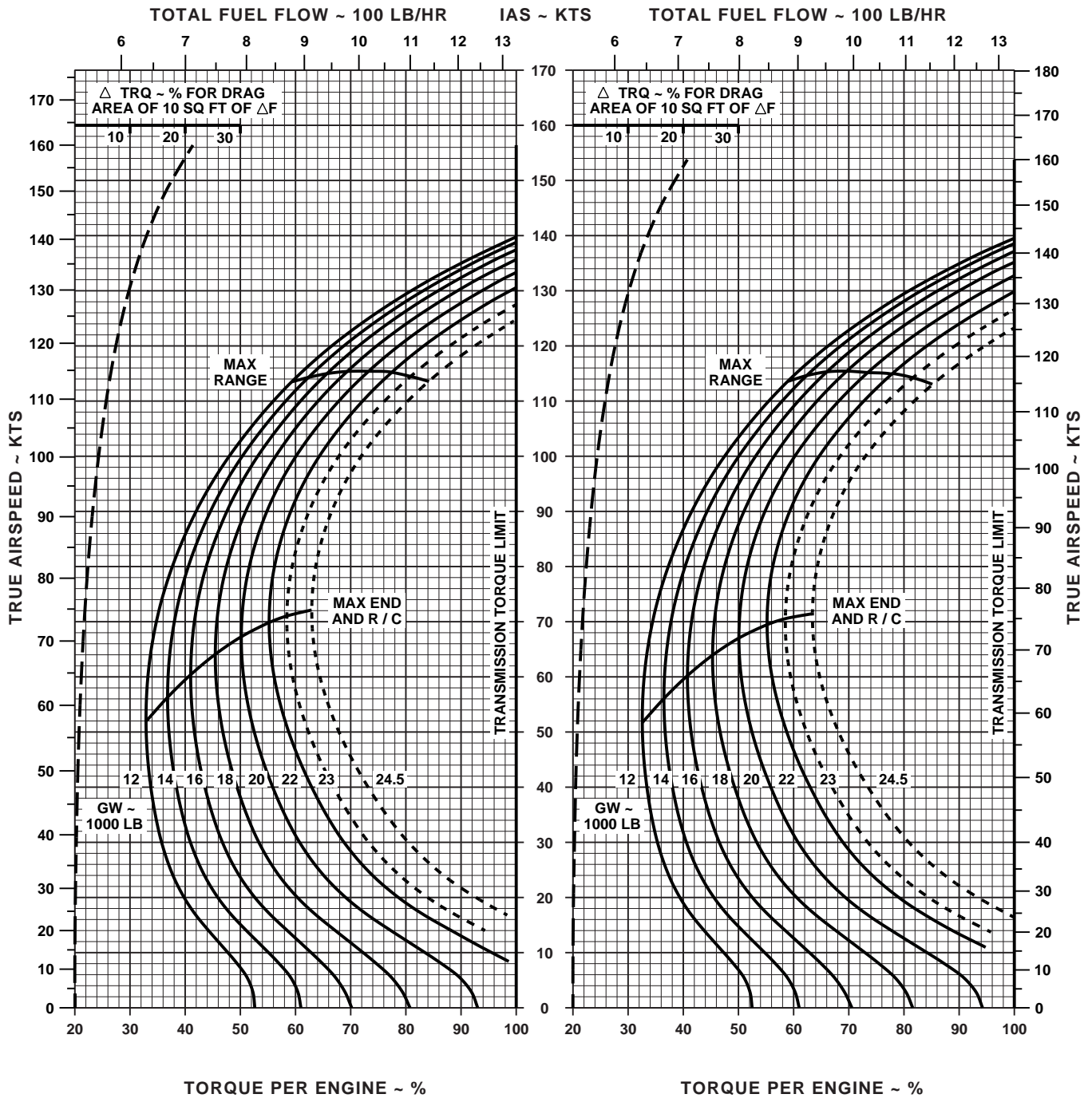

DATA BASE: FLIGHT TEST

AA0541
SA

Figure 7-10. Cruise High Drag - Pressure Altitude 2,000 Feet (Sheet 2 of 6)

CRUISE

PRESS ALT: 2000 FT

CRUISE
2000 FT
T700 (2)



-10°C

0°C

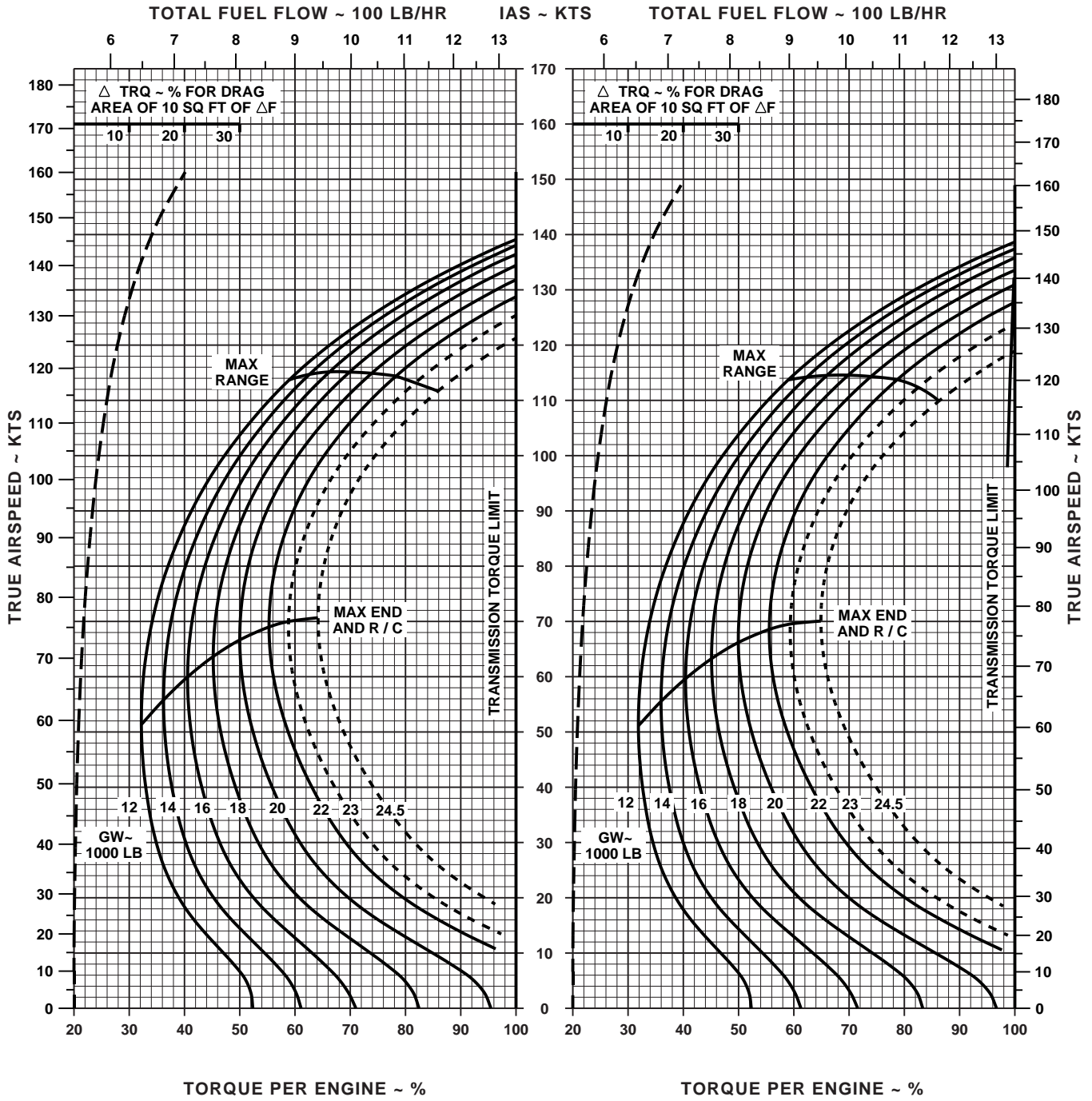

DATA BASE: FLIGHT TEST

AA0542
SA

Figure 7-10. Cruise High Drag - Pressure Altitude 2,000 Feet (Sheet 3 of 6)

CRUISE

PRESS ALT: 2000 FT

CRUISE
2000 FT
T700 (2)



10°C

20°C

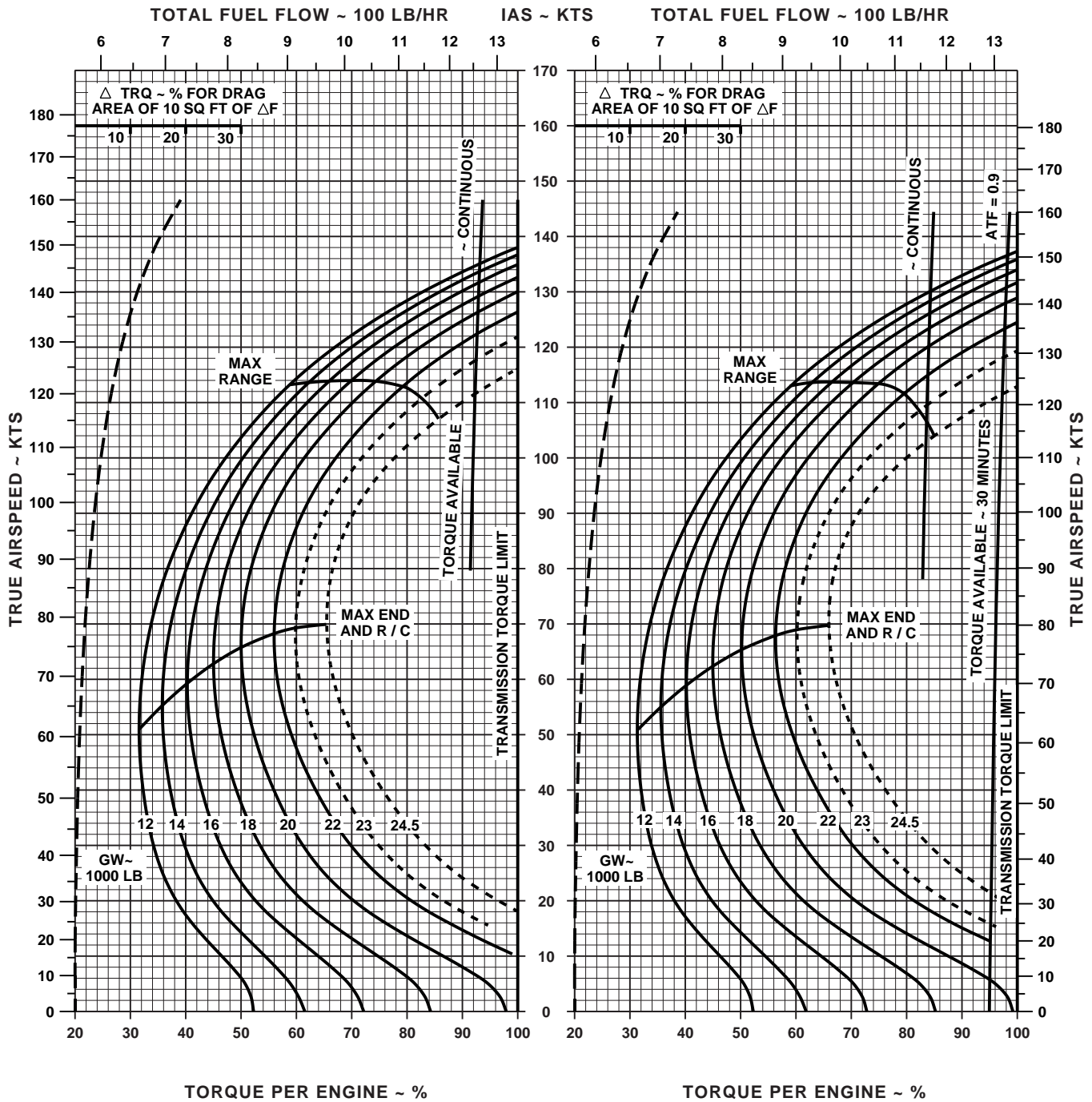

DATA BASE: FLIGHT TEST

AA0543
SA

Figure 7-10. Cruise High Drag - Pressure Altitude 2,000 Feet (Sheet 4 of 6)

CRUISE

PRESS ALT: 2000 FT

CRUISE
2000 FT
T700 (2)



30°C

40°C

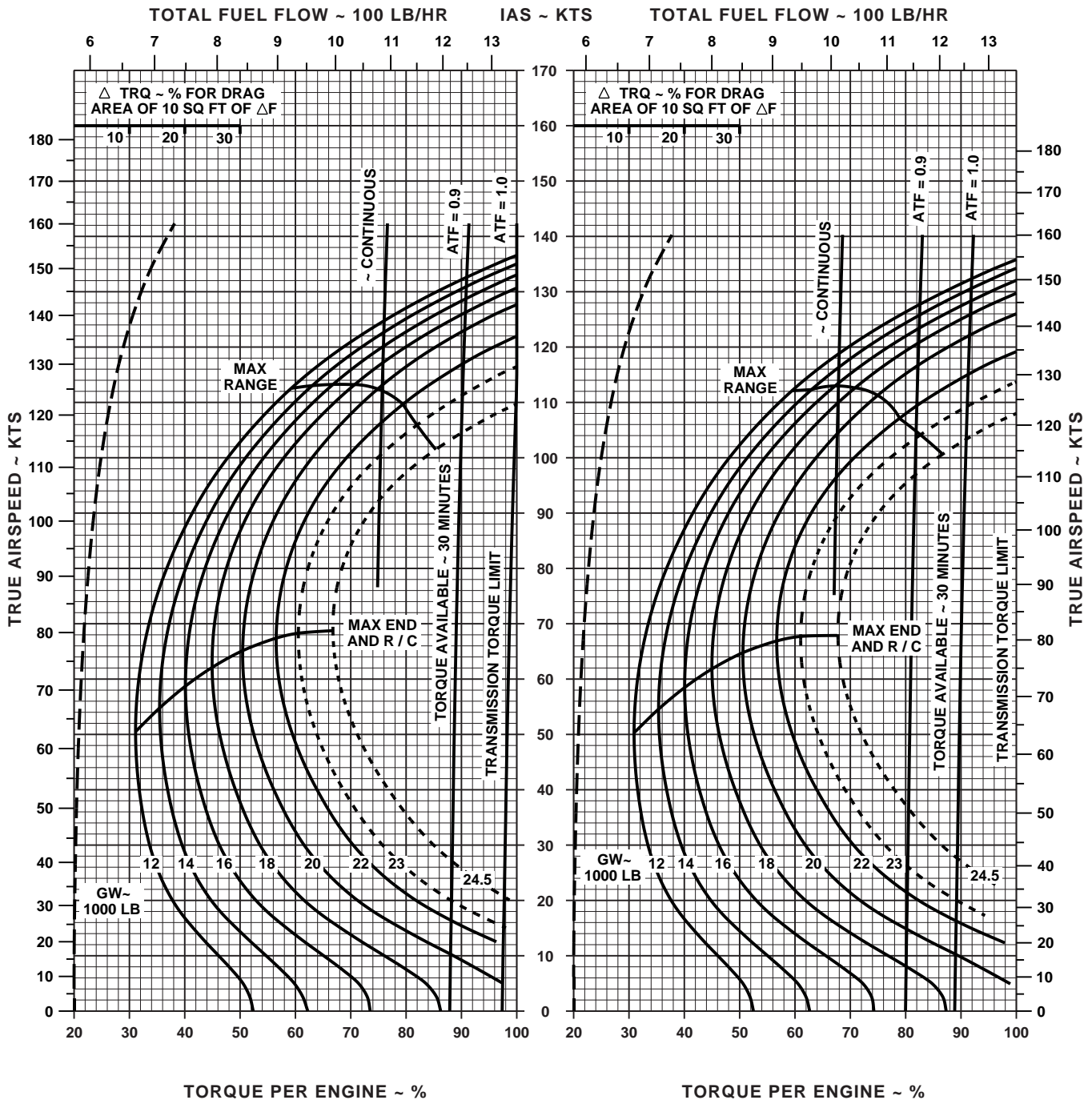

DATA BASE: FLIGHT TEST

AA0544
SA

Figure 7-10. Cruise High Drag - Pressure Altitude 2,000 Feet (Sheet 5 of 6)

CRUISE

PRESS ALT: 2000 FT

CRUISE
2000 FT
T700 (2)



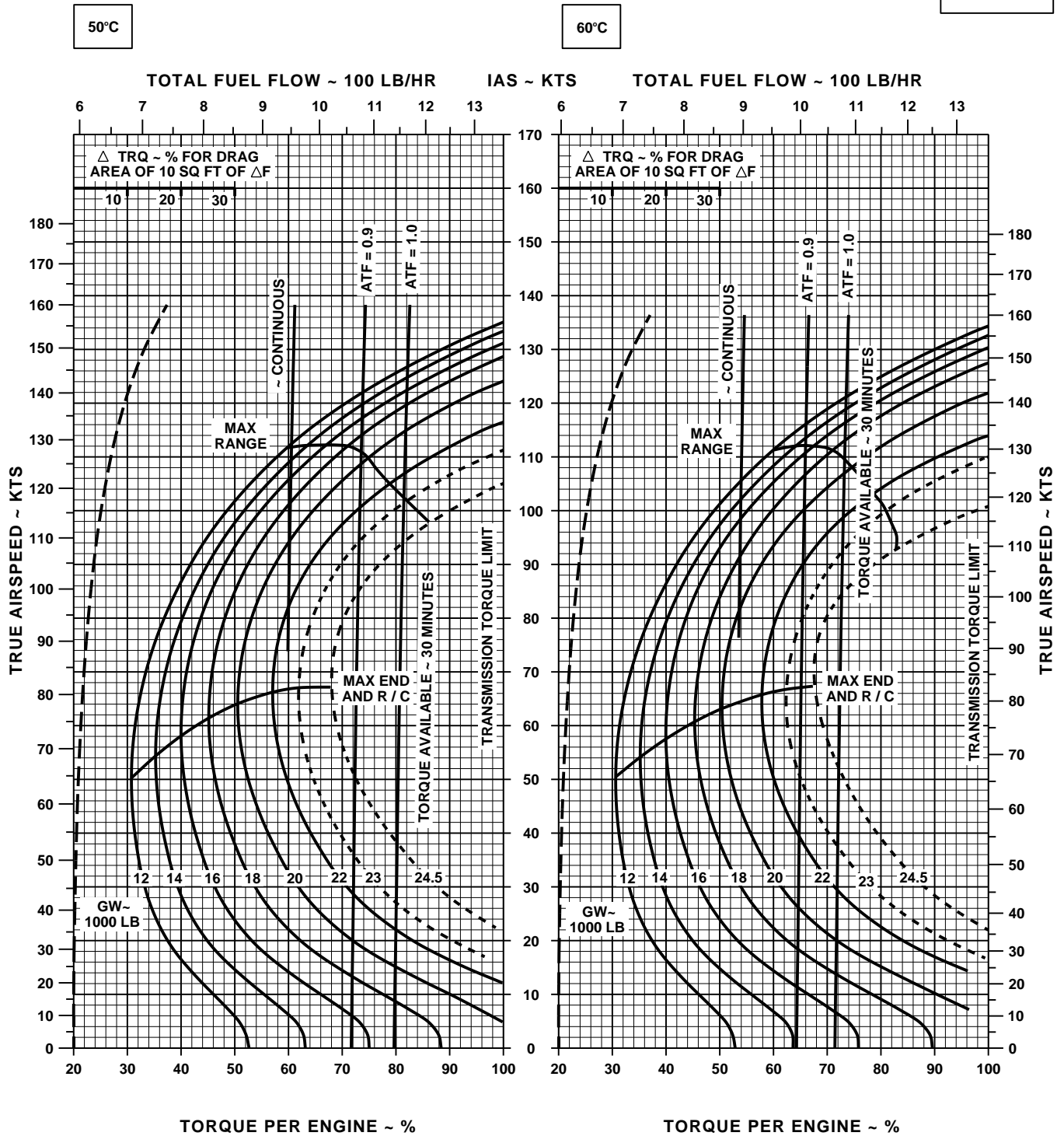

DATA BASE: FLIGHT TEST

AA0545
SA

Figure 7-10. Cruise High Drag - Pressure Altitude 2,000 Feet (Sheet 6 of 6)

CRUISE

CLEAN CONFIGURATION

PRESS ALT: 4000 FT

CRUISE
4000 FT
T700 (2)

-50°C

-40°C

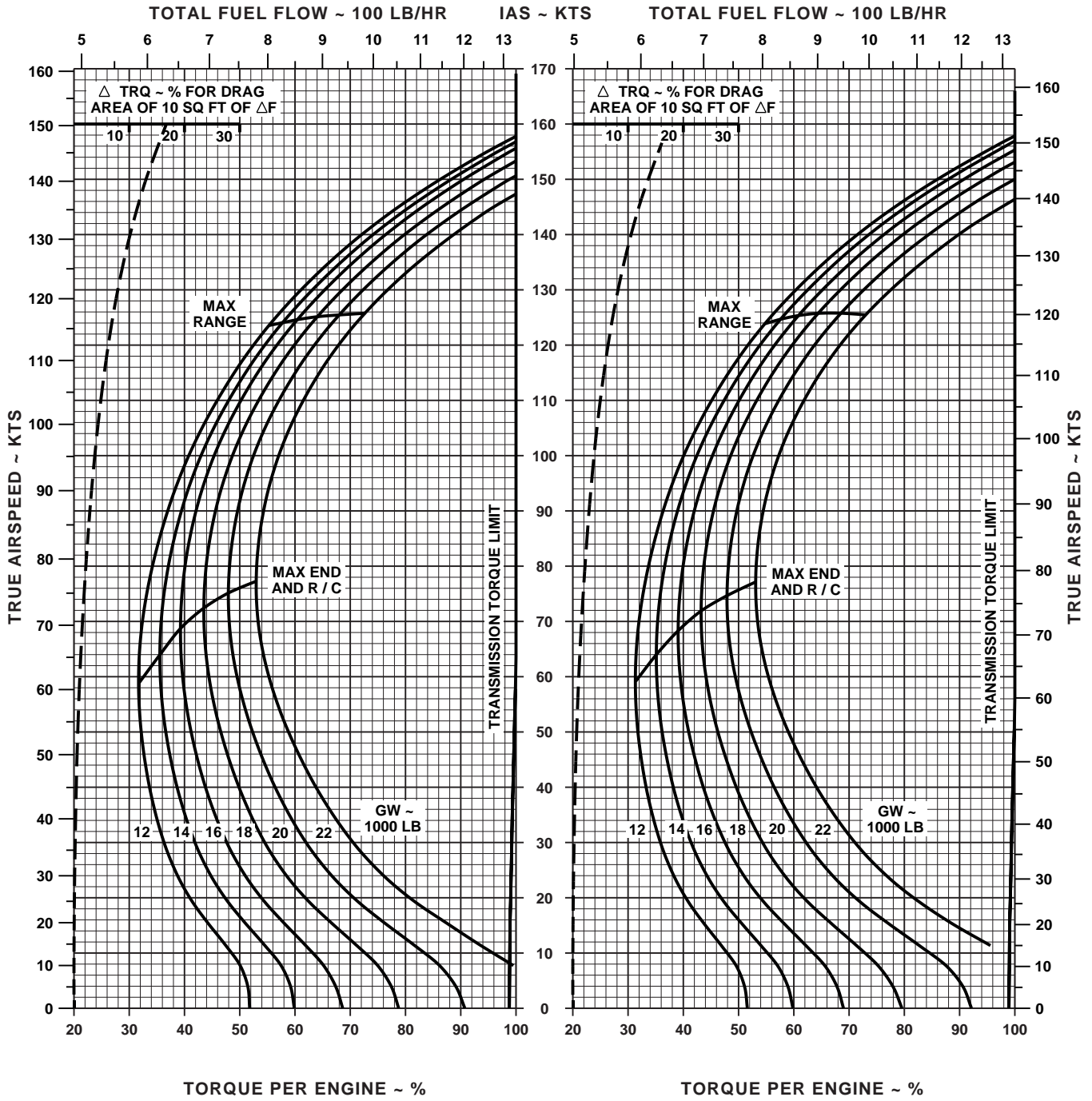

DATA BASE: FLIGHT TEST

AA0455
SA

Figure 7-11. Cruise - Pressure Altitude 4,000 Feet (Sheet 1 of 6)

CRUISE

CLEAN CONFIGURATION

PRESS ALT: 4000 FT

CRUISE
4000 FT
T700 (2)

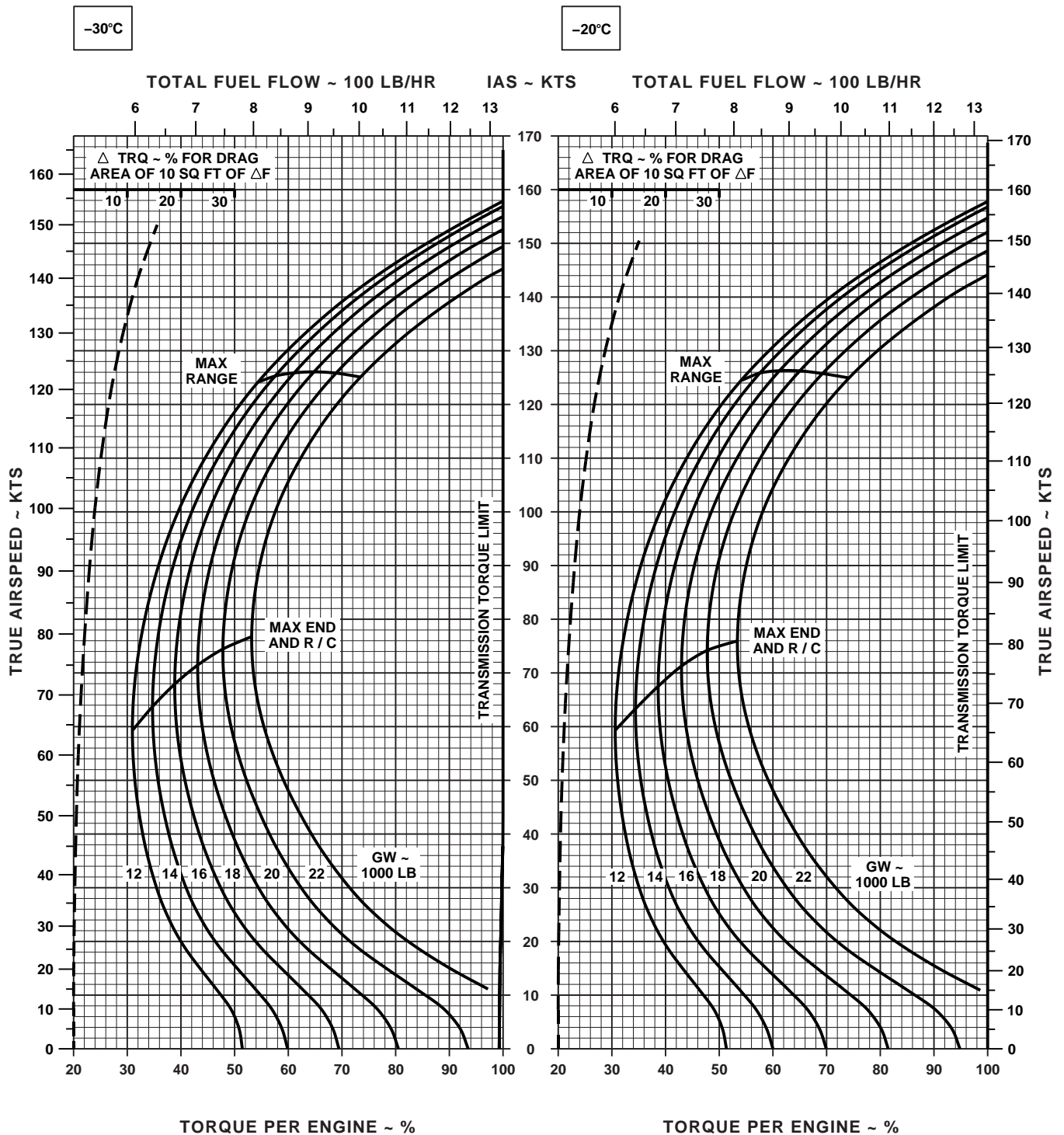

DATA BASE: FLIGHT TEST

AA0454
SA

Figure 7-11. Cruise - Pressure Altitude 4,000 Feet (Sheet 2 of 6)

CRUISE

CLEAN CONFIGURATION

PRESS ALT: 4000 FT

CRUISE
4000 FT
T700 (2)

-10°C

0°C

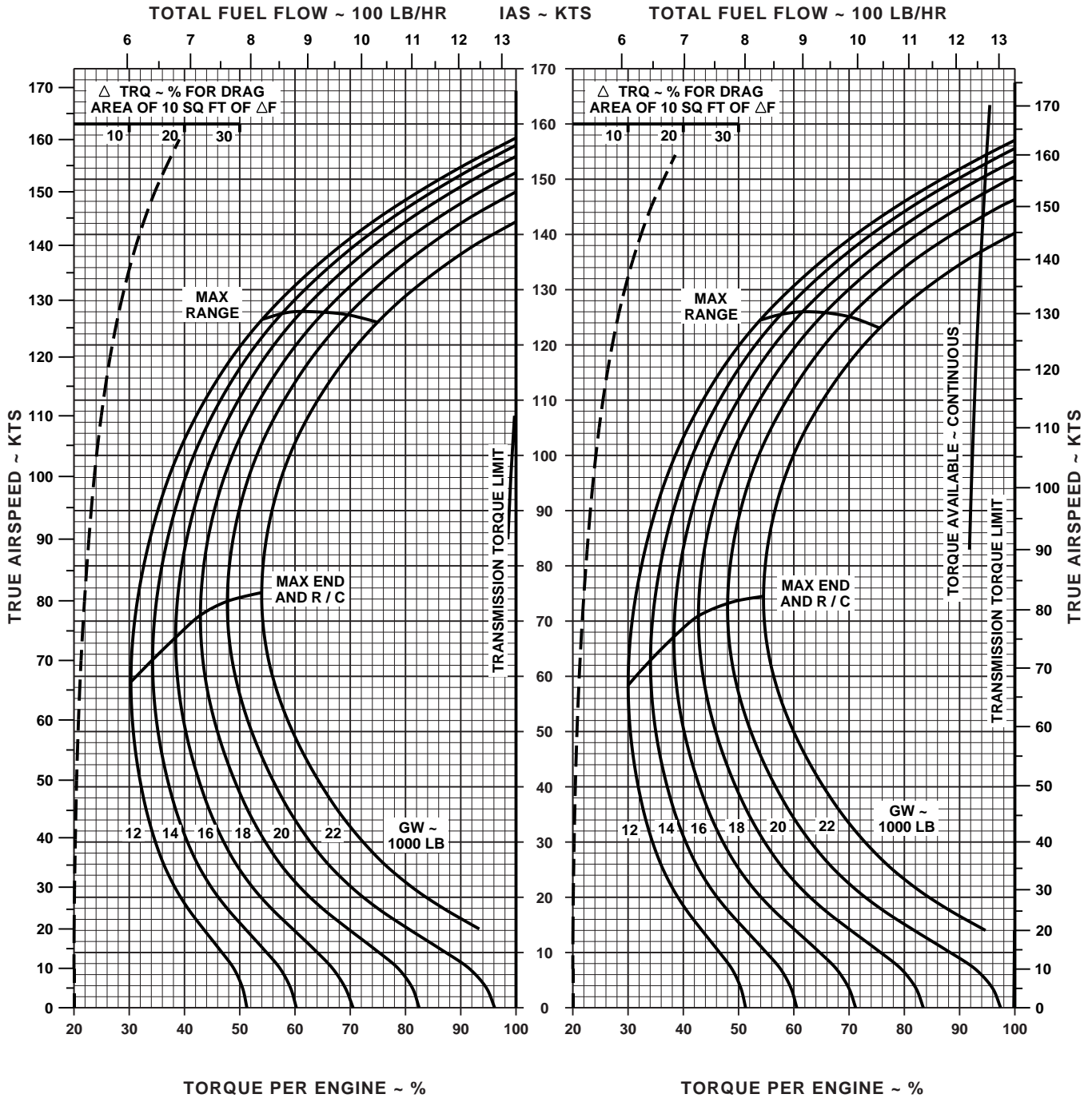

DATA BASE: FLIGHT TEST

AA0453
SA

Figure 7-11. Cruise - Pressure Altitude 4,000 Feet (Sheet 3 of 6)

CRUISE

CLEAN CONFIGURATION

PRESS ALT: 4000 FT

CRUISE
4000 FT
T700 (2)

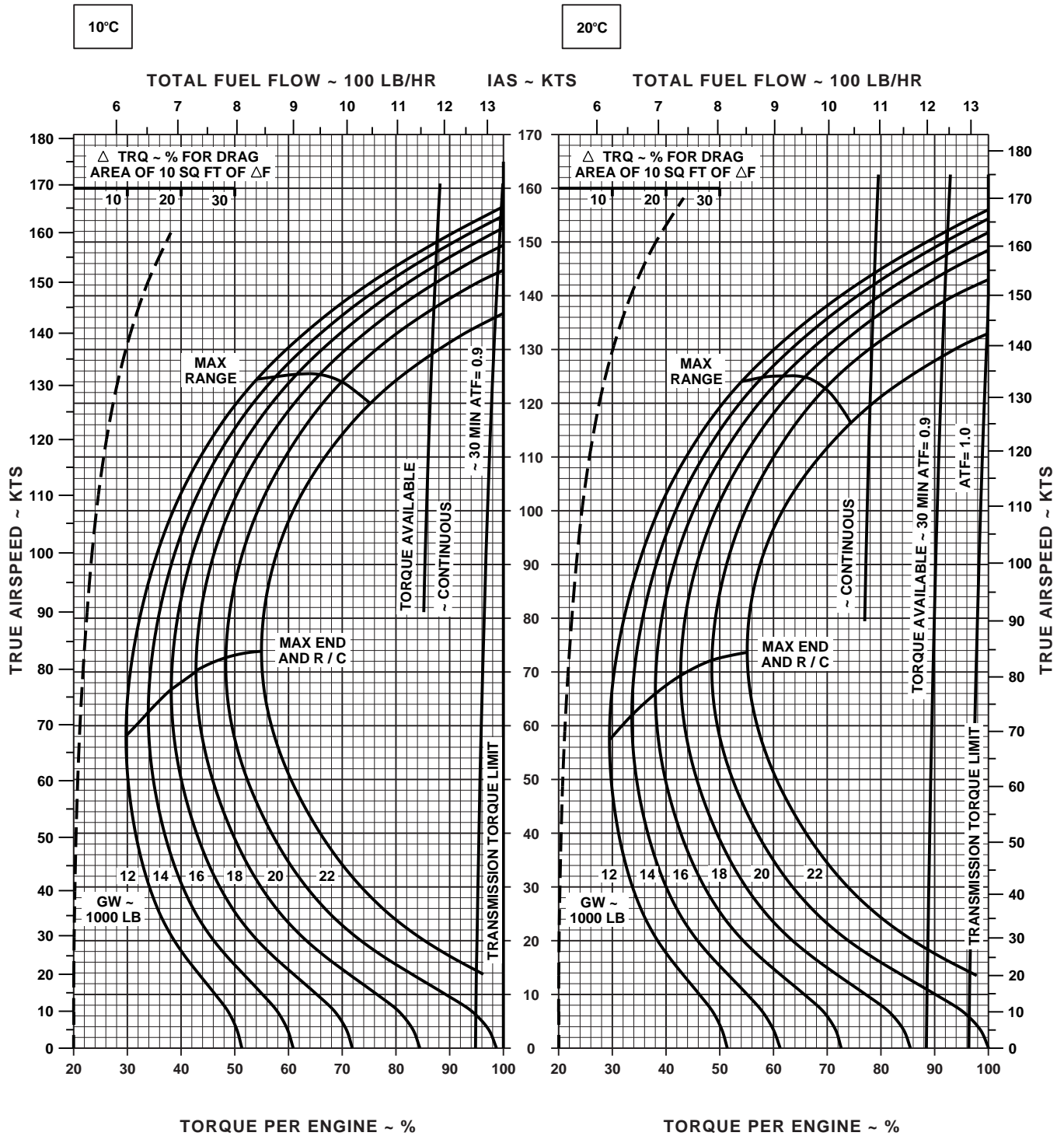

DATA BASE: FLIGHT TEST

AA0456
SA

Figure 7-11. Cruise - Pressure Altitude 4,000 Feet (Sheet 4 of 6)

CRUISE

CLEAN CONFIGURATION

PRESS ALT: 4000 FT

CRUISE
4000 FT
T700 (2)

30°C

40°C

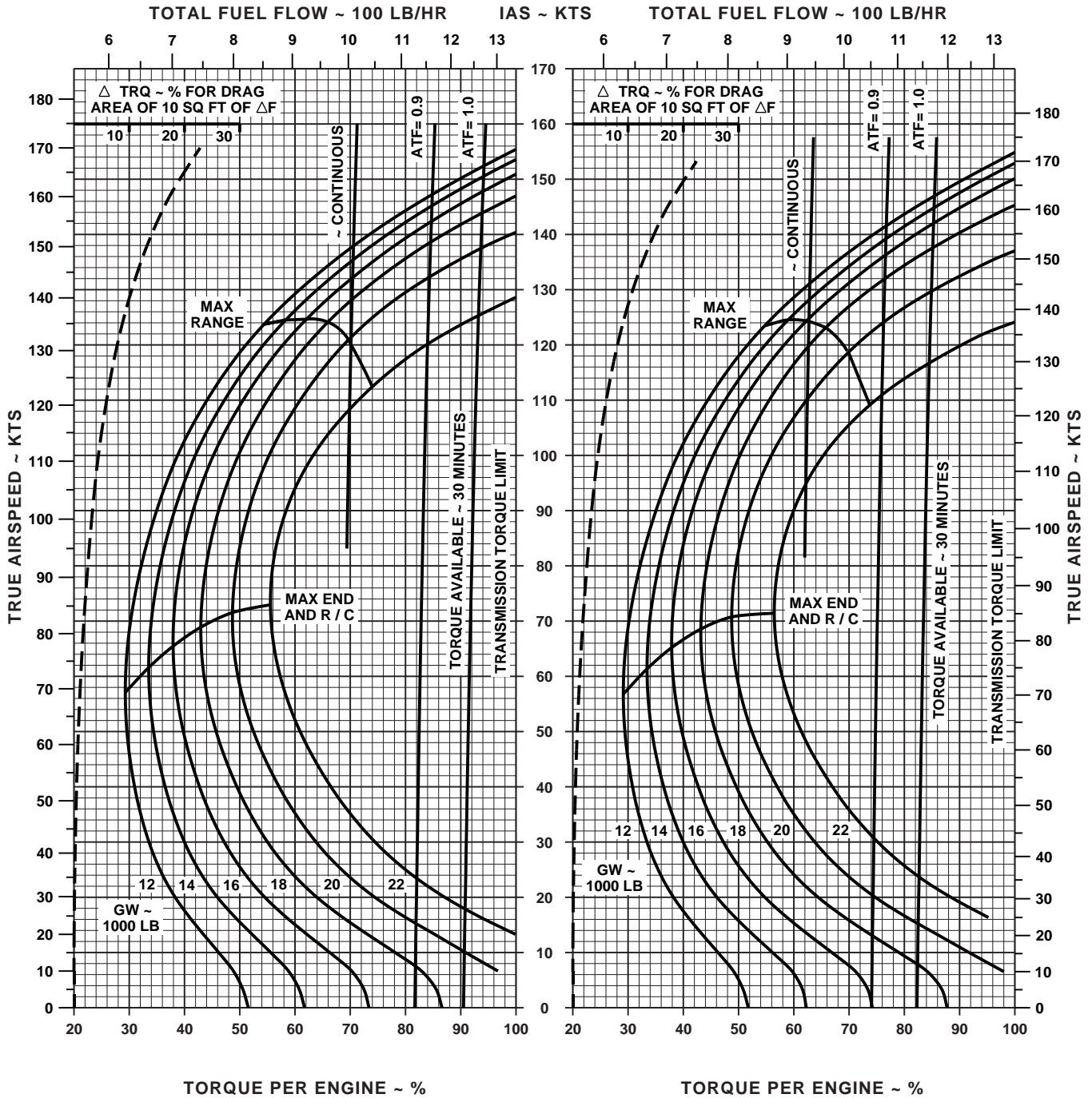

DATA BASE: FLIGHT TEST

AA0457
SA

Figure 7-11. Cruise - Pressure Altitude 4,000 Feet (Sheet 5 of 6)

CRUISE

CLEAN CONFIGURATION

PRESS ALT: 4000 FT

CRUISE
4000 FT
T700 (2)

50°C

60°C

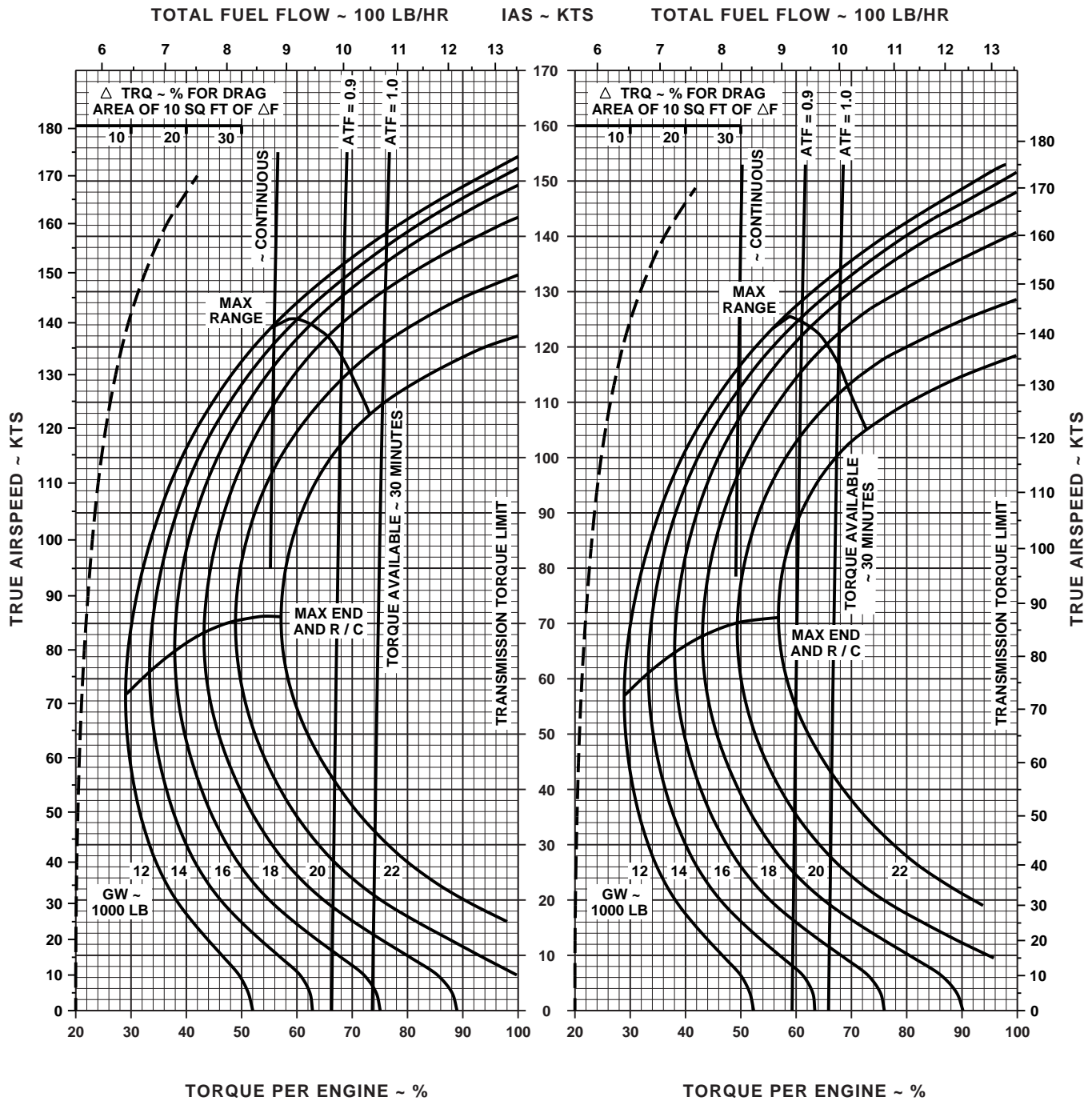

DATA BASE: FLIGHT TEST

AA0458
SA

Figure 7-11. Cruise - Pressure Altitude 4,000 Feet (Sheet 6 of 6)

CRUISE

PRESS ALT: 4000 FT

CRUISE
4000 FT
T700 (2)



-50°C

-40°C

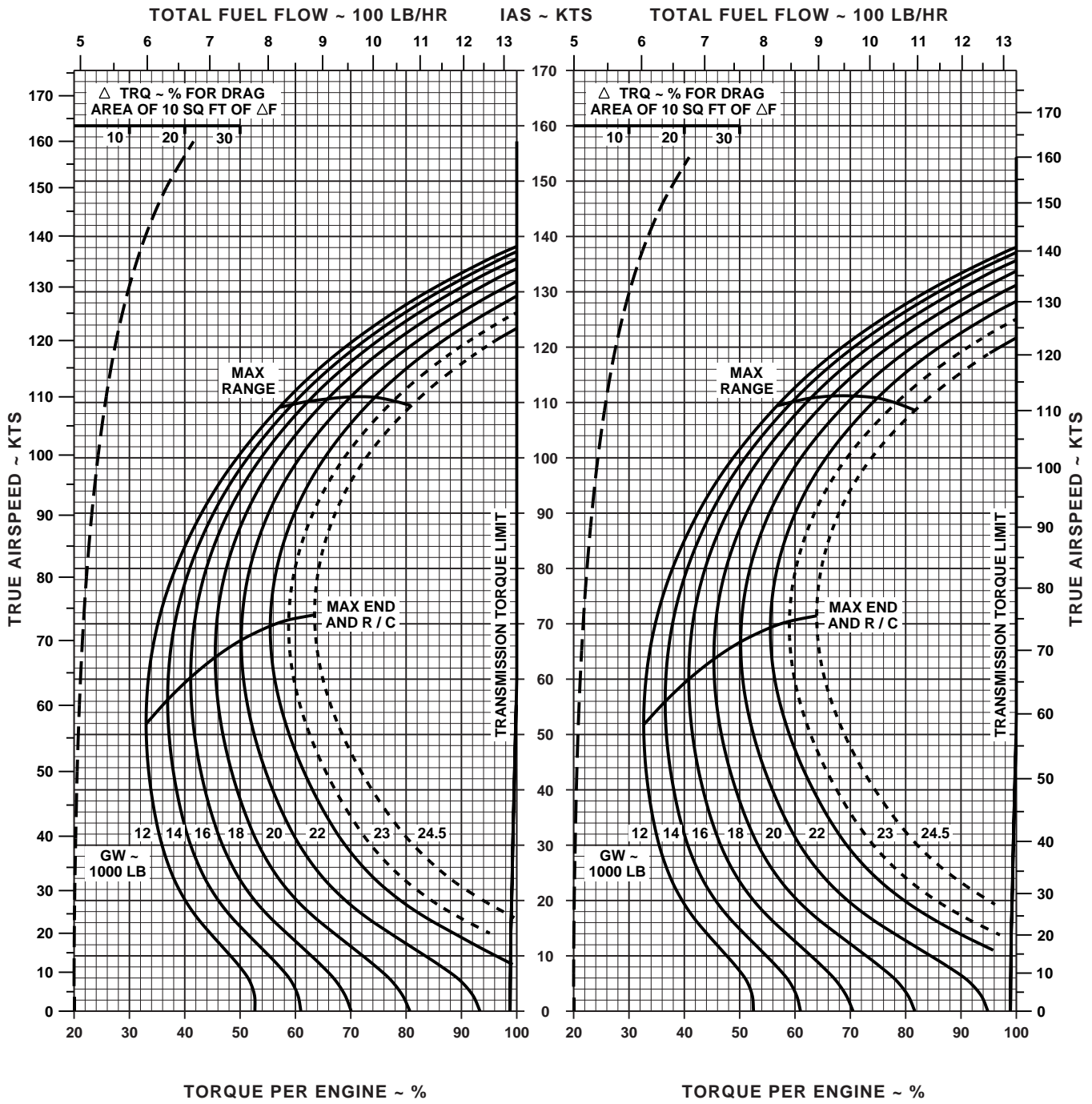

DATA BASE: FLIGHT TEST

AA0546
SA

Figure 7-12. Cruise High Drag - Pressure Altitude 4,000 Feet (Sheet 1 of 6)

CRUISE

PRESS ALT: 4000 FT

CRUISE
4000 FT
T700 (2)



-30°C

-20°C

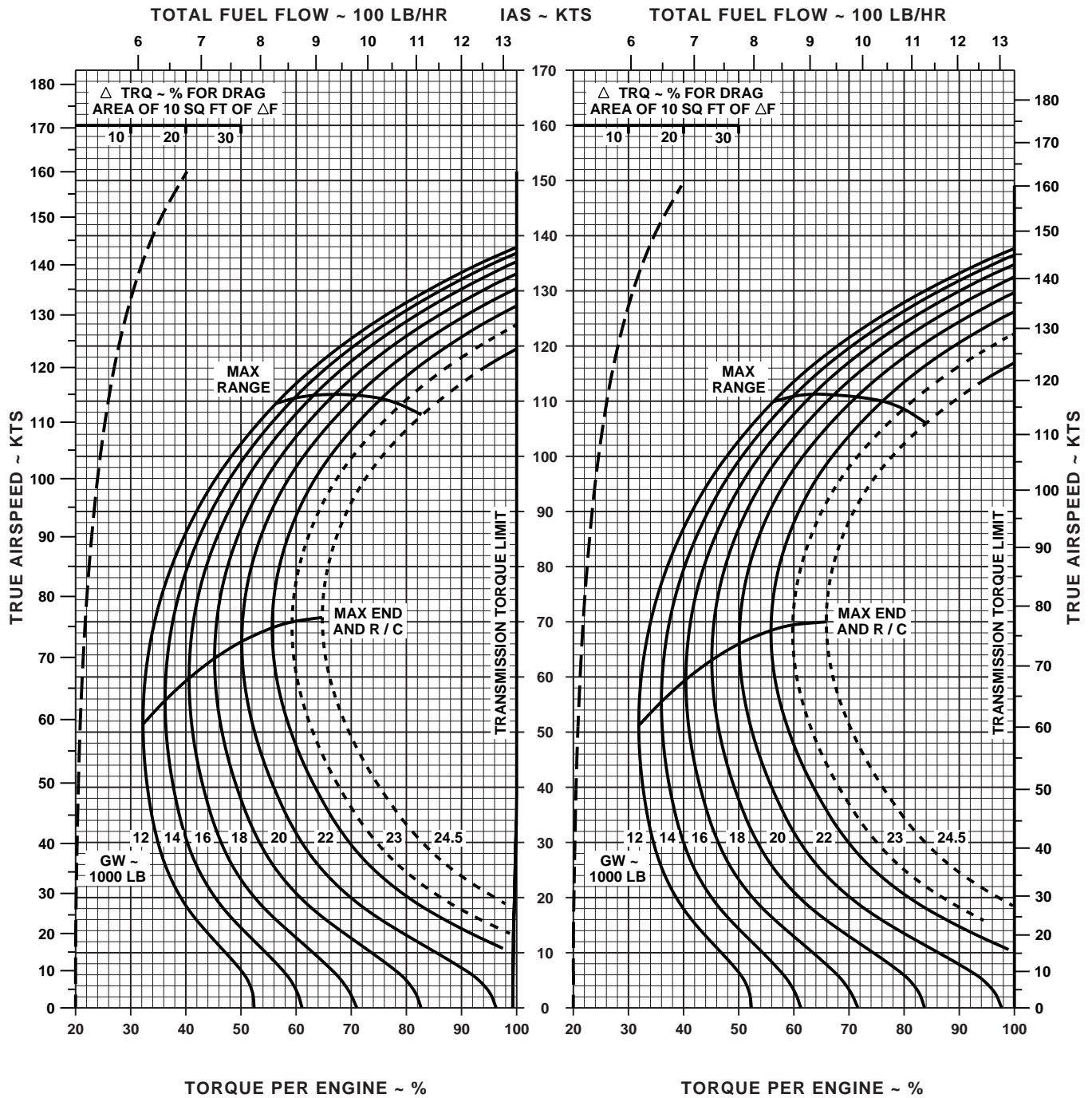

DATA BASE: FLIGHT TEST

AA0547
SA

Figure 7-12. Cruise High Drag - Pressure Altitude 4,000 Feet (Sheet 2 of 6)

CRUISE

PRESS ALT: 4000 FT

CRUISE
4000 FT
T700 (2)



-10°C

0°C

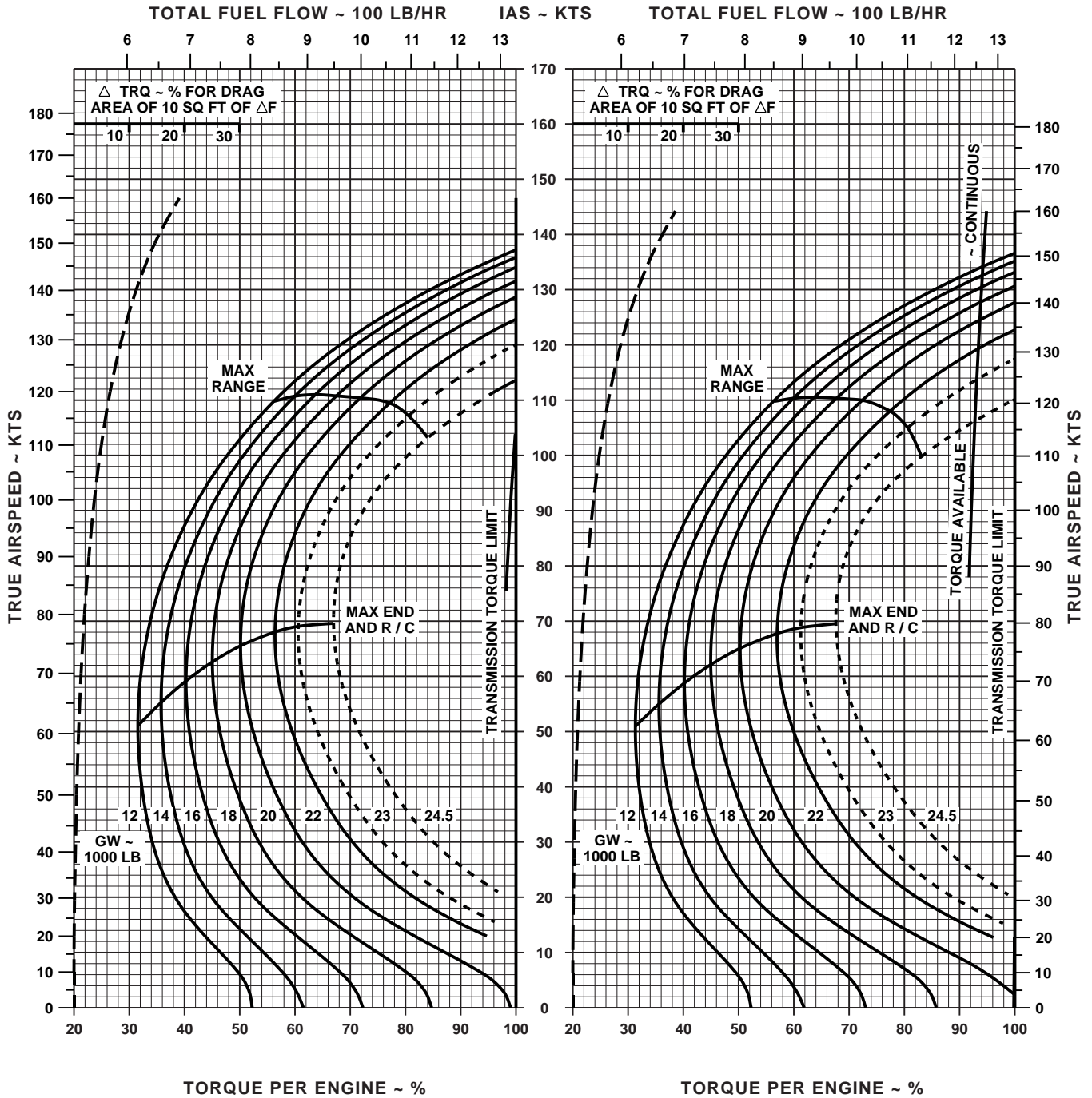

DATA BASE: FLIGHT TEST

AA0548
SA

Figure 7-12. Cruise High Drag - Pressure Altitude 4,000 Feet (Sheet 3 of 6)

CRUISE

PRESS ALT: 4000 FT

CRUISE
4000 FT
T700 (2)



10°C

20°C

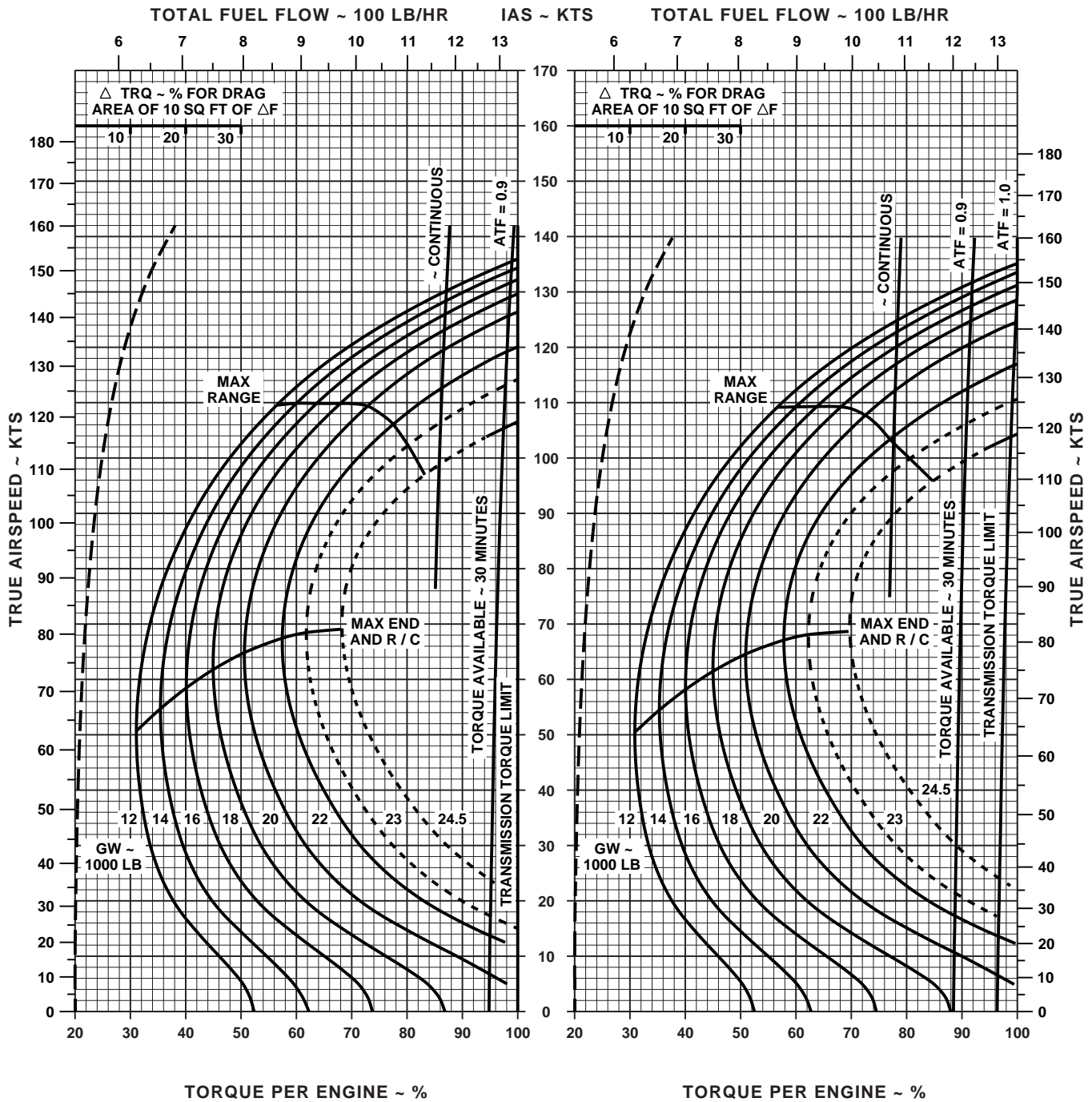

DATA BASE: FLIGHT TEST

AA0549
SA

Figure 7-12. Cruise High Drag - Pressure Altitude 4,000 Feet (Sheet 4 of 6)

CRUISE

PRESS ALT: 4000 FT

CRUISE
4000 FT
T700 (2)



30°C

40°C

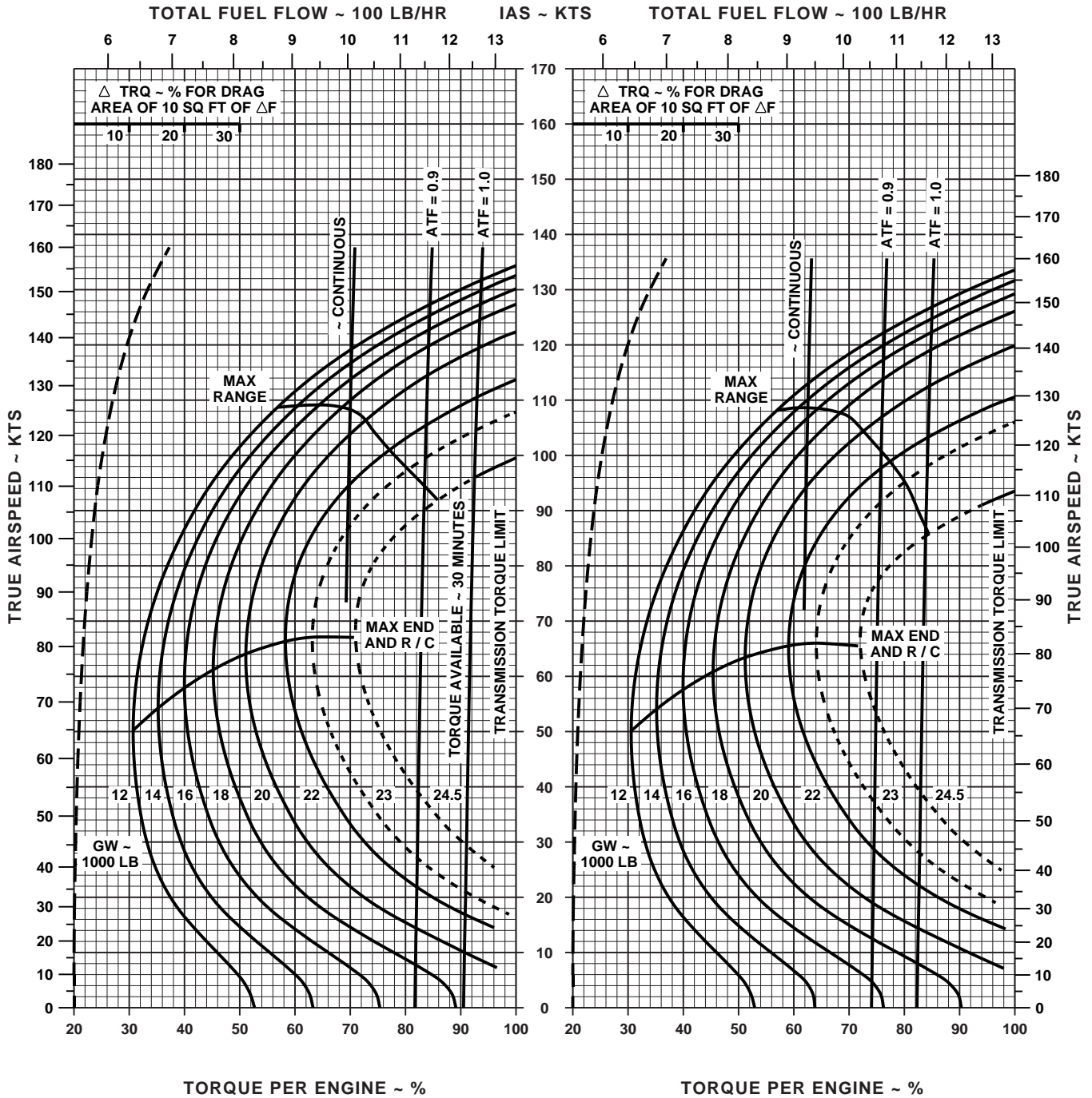

DATA BASE: FLIGHT TEST

AA0550
SA

Figure 7-12. Cruise High Drag - Pressure Altitude 4,000 Feet (Sheet 5 of 6)

CRUISE

PRESS ALT: 4000 FT

CRUISE
4000 FT
T700 (2)



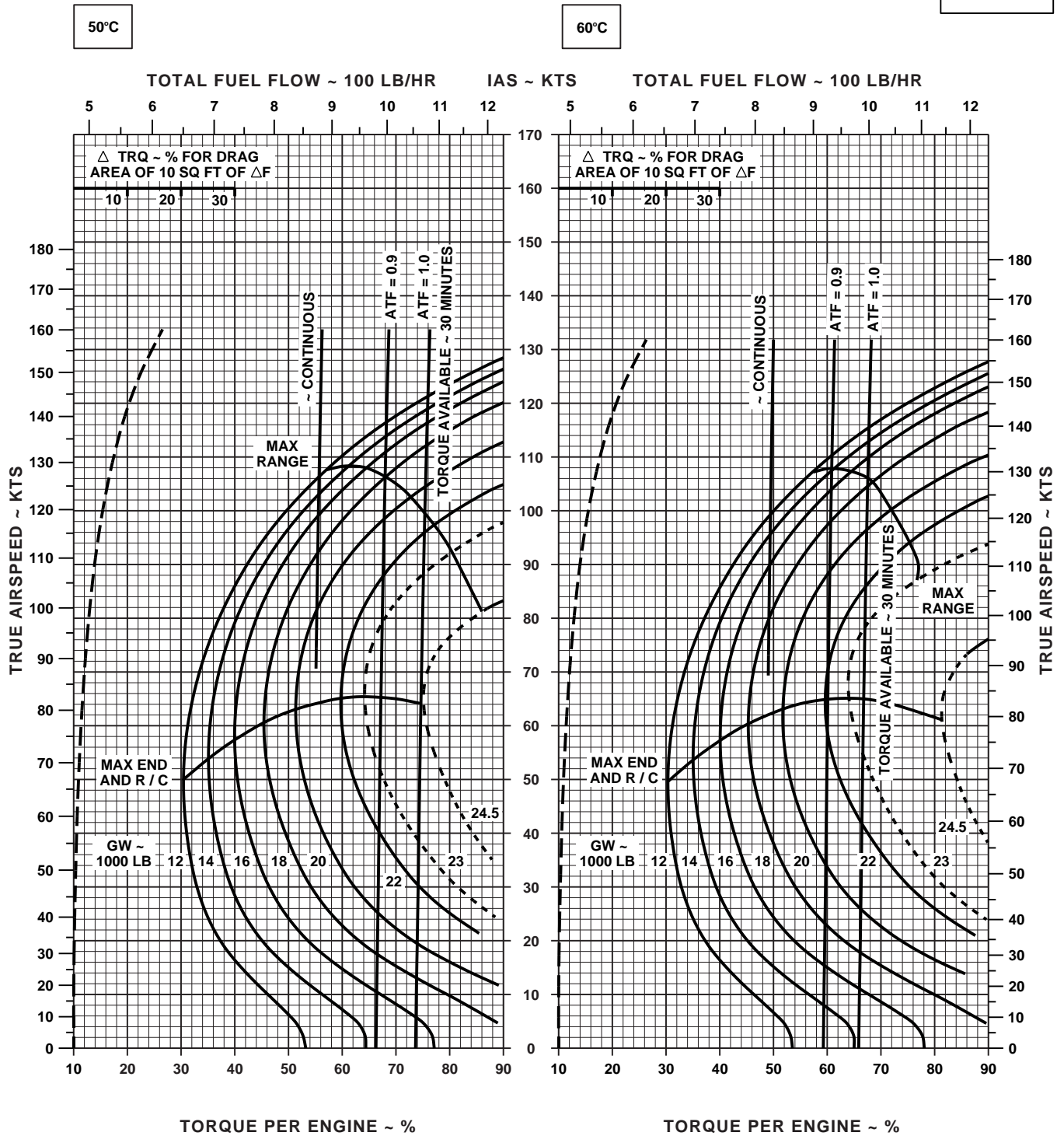

DATA BASE: FLIGHT TEST

AA0551
SA

Figure 7-12. Cruise High Drag - Pressure Altitude 4,000 Feet (Sheet 6 of 6)

CRUISE

CLEAN CONFIGURATION

PRESS ALT: 6000 FT

CRUISE
6000 FT
T700 (2)

-50°C

-40°C

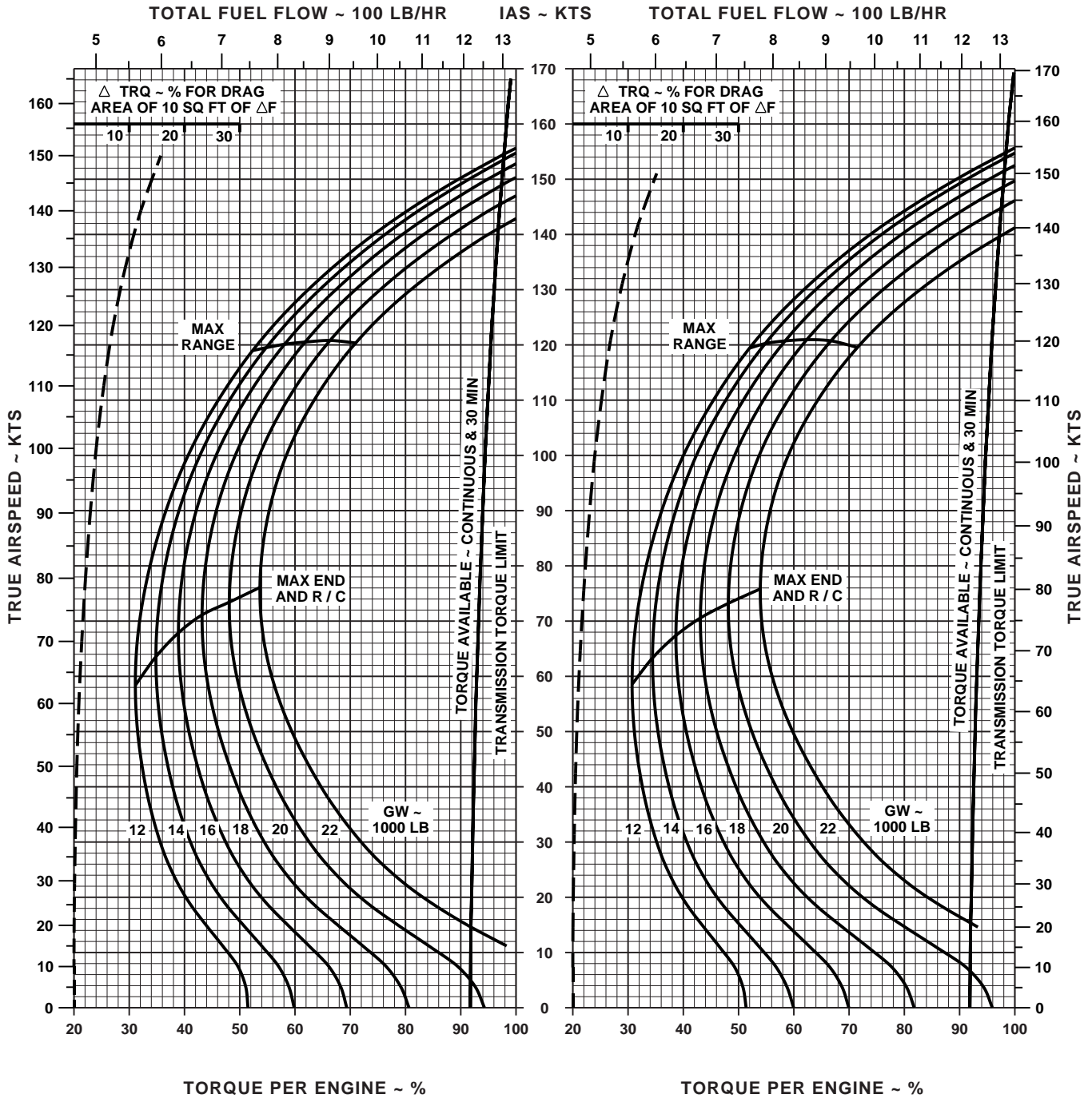

DATA BASE: FLIGHT TEST

AA0461
SA

Figure 7-13. Cruise - Pressure Altitude 6,000 Feet (Sheet 1 of 6)

CRUISE

CLEAN CONFIGURATION

PRESS ALT: 6000 FT

CRUISE
6000 FT
T700 (2)

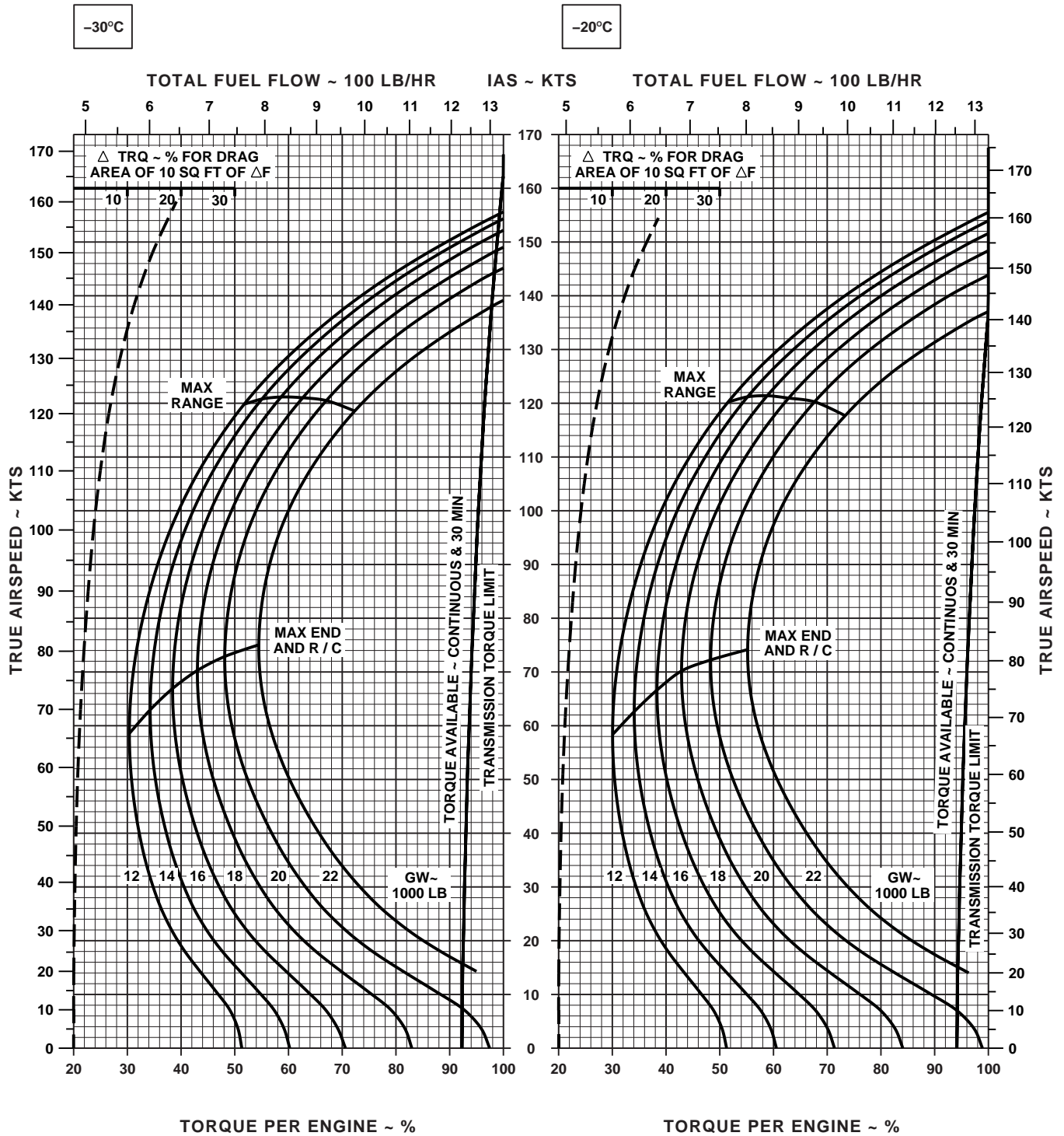

DATA BASE: FLIGHT TEST

AA0460
SA

Figure 7-13. Cruise - Pressure Altitude 6,000 Feet (Sheet 2 of 6)

CRUISE

CLEAN CONFIGURATION

PRESS ALT: 6000 FT

CRUISE
6000 FT
T700 (2)

-10°C

0°C

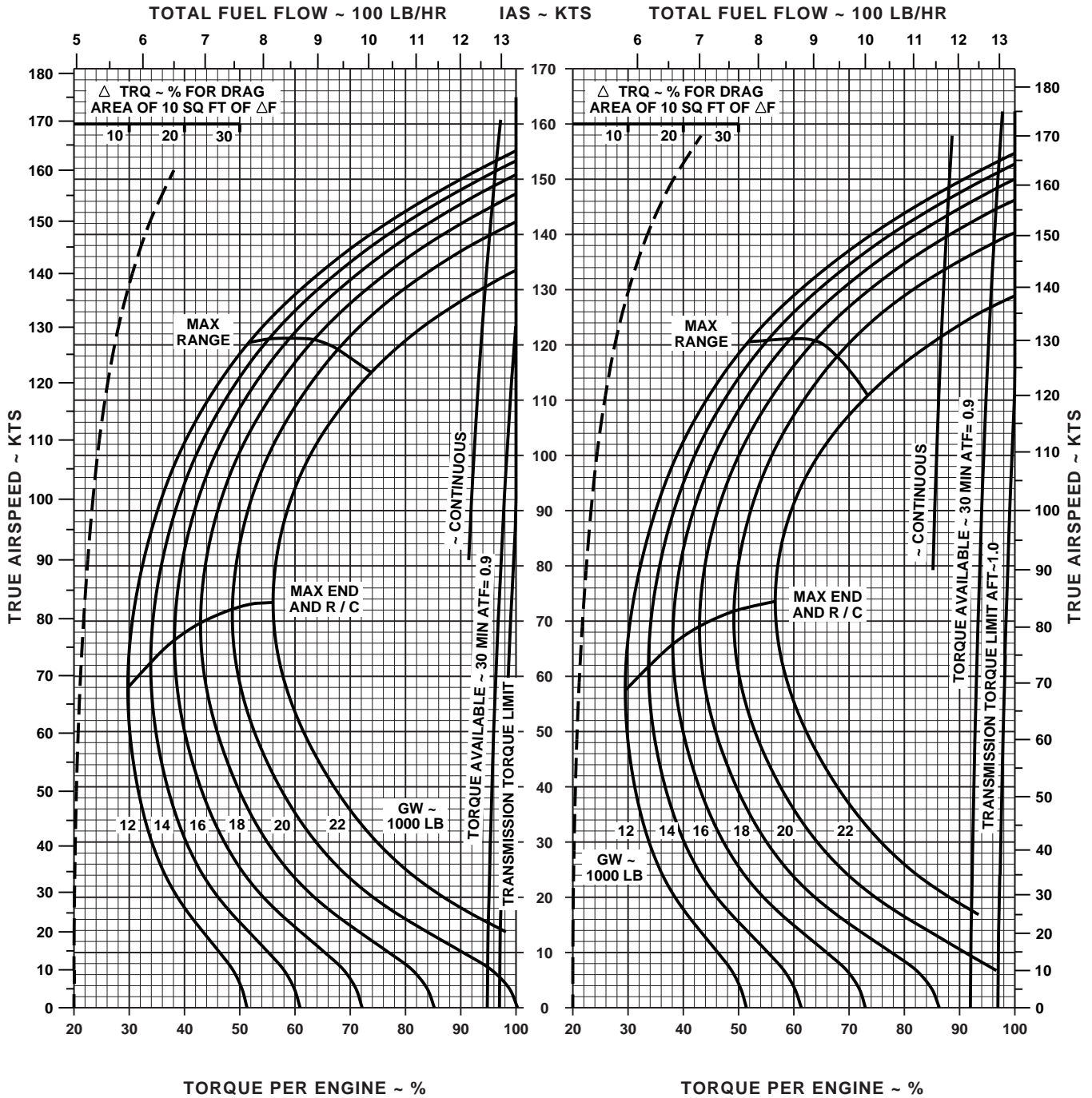

DATA BASE: FLIGHT TEST

AA0459
SA

Figure 7-13. Cruise - Pressure Altitude 6,000 Feet (Sheet 3 of 6)

CRUISE

CLEAN CONFIGURATION

PRESS ALT: 6000 FT

CRUISE
6000 FT
T700 (2)

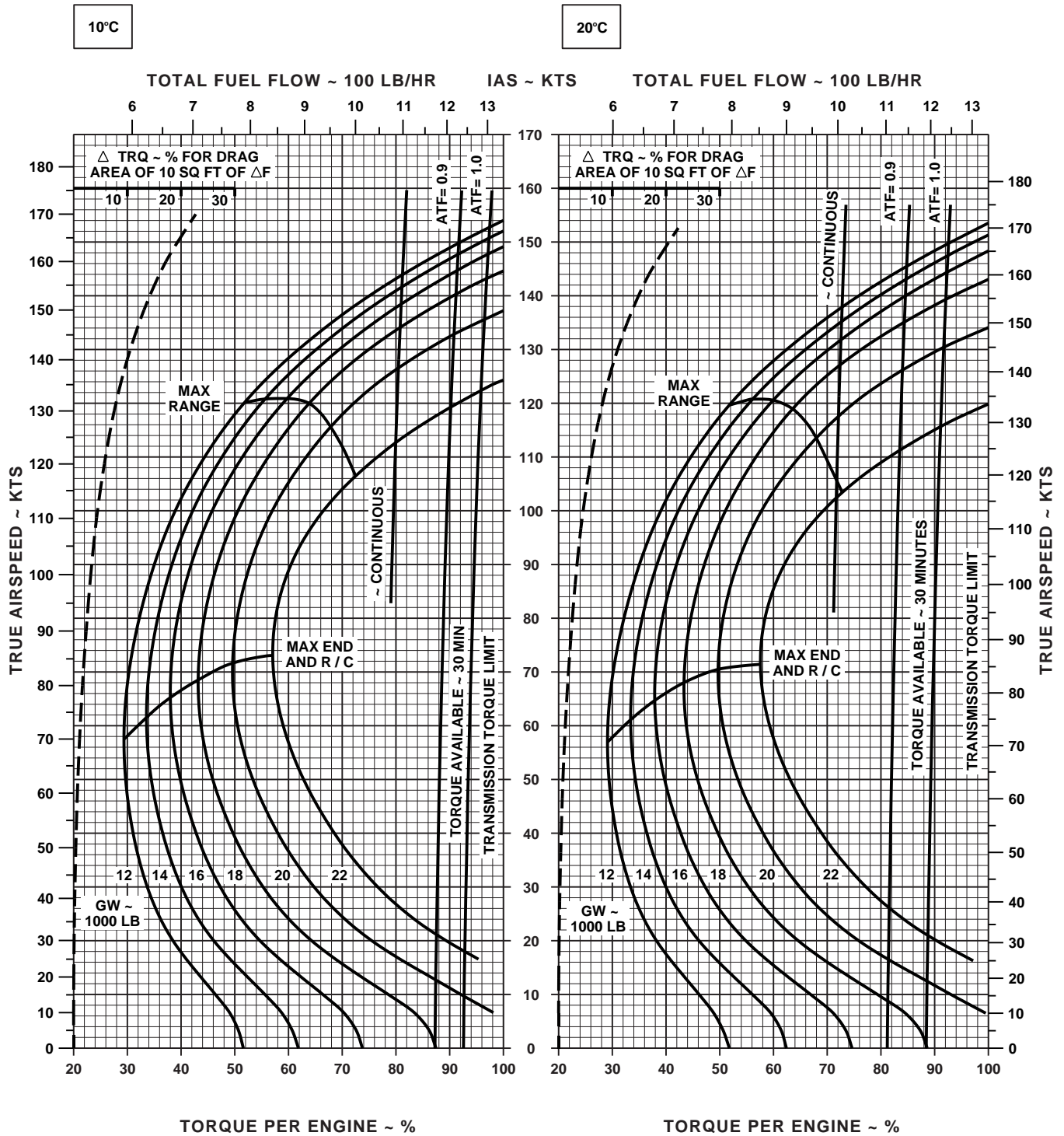

DATA BASE: FLIGHT TEST

AA0462
SA

Figure 7-13. Cruise - Pressure Altitude 6,000 Feet (Sheet 4 of 6)

CRUISE CLEAN CONFIGURATION PRESS ALT: 6000 FT

CRUISE
6000 FT
T700 (2)

30°C

40°C

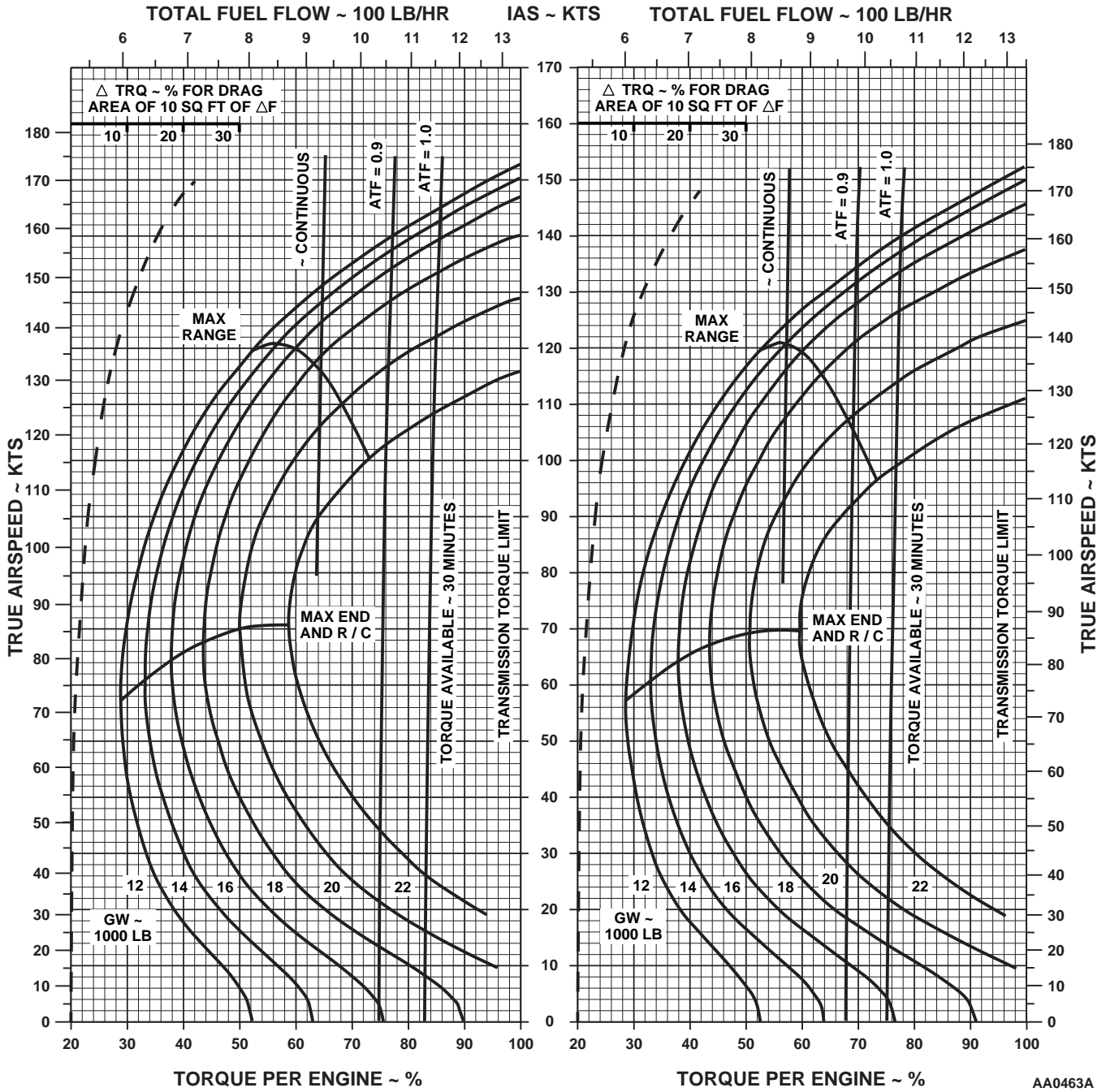

AA0463A
SA

Figure 7-13. Cruise - Pressure Altitude 6,000 Feet (Sheet 5 of 6)

CRUISE

CLEAN CONFIGURATION

PRESS ALT: 6000 FT

CRUISE
6000 FT
T700 (2)

50°C

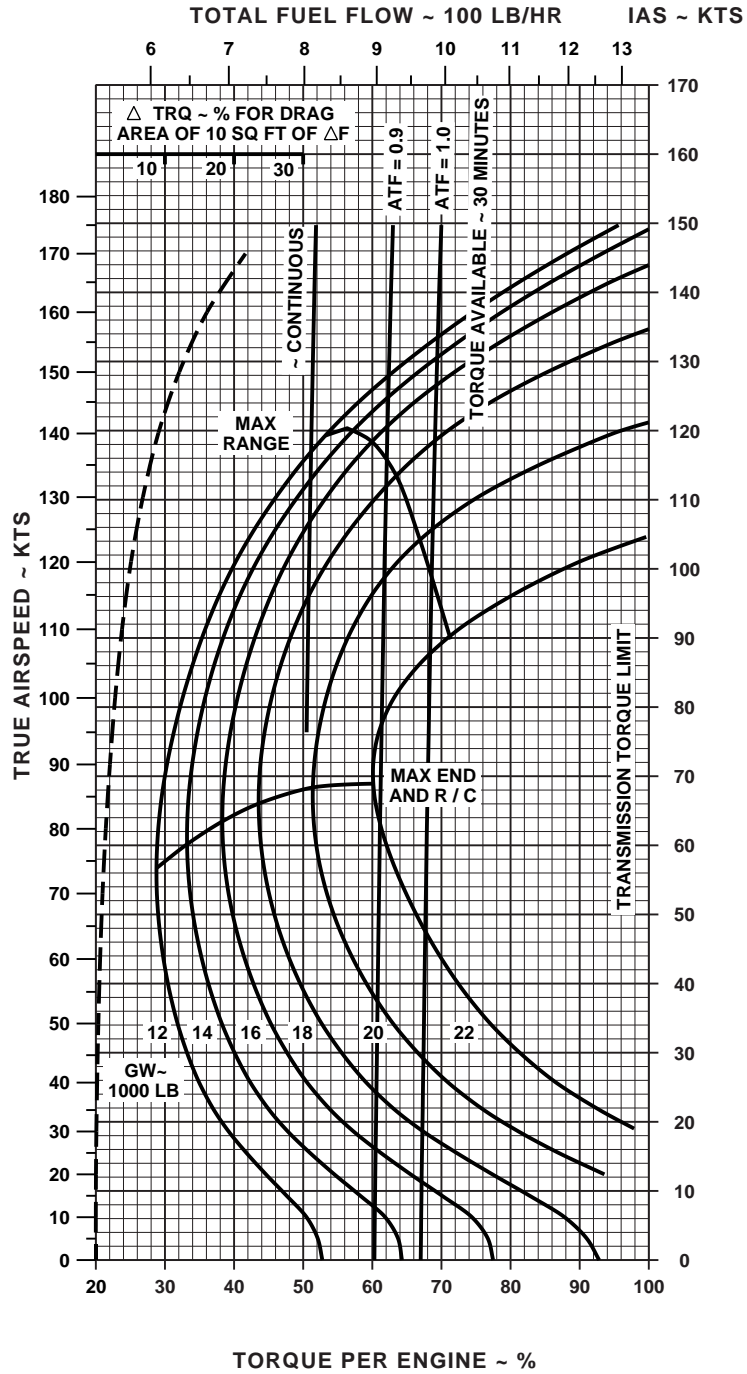

DATA BASIS: FLIGHT TEST

AA0464A
SA

Figure 7-13. Cruise - Pressure Altitude 6,000 Feet (Sheet 6 of 6)

CRUISE

PRESS ALT: 6000 FT

CRUISE
6000 FT
T700 (2)



-50°C

-40°C

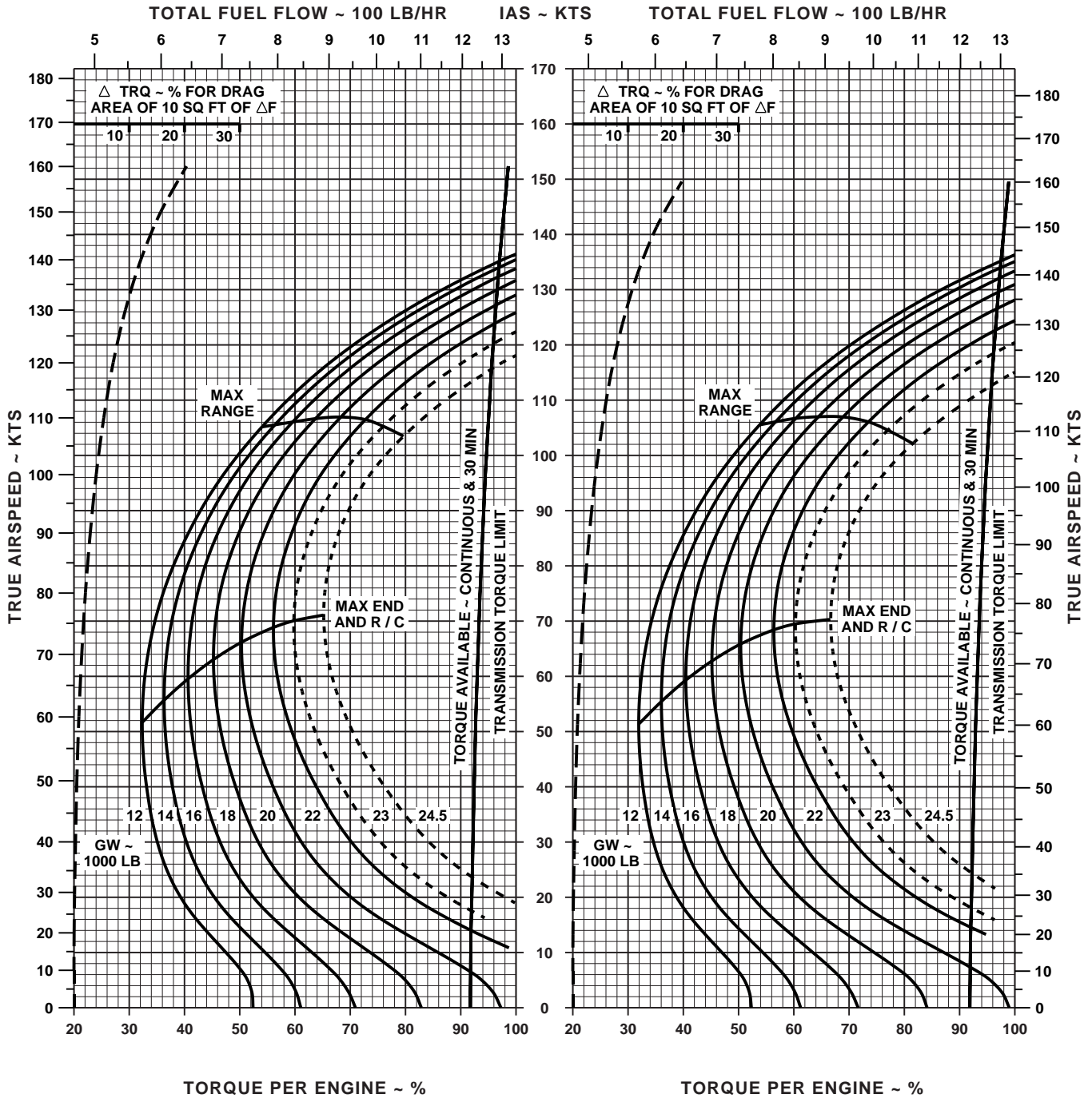

DATA BASE: FLIGHT TEST

AA0552
SA

Figure 7-14. Cruise High Drag - Pressure Altitude 6,000 Feet (Sheet 1 of 6)

CRUISE

PRESS ALT: 6000 FT

CRUISE
6000 FT
T700 (2)



-30°C

-20°C

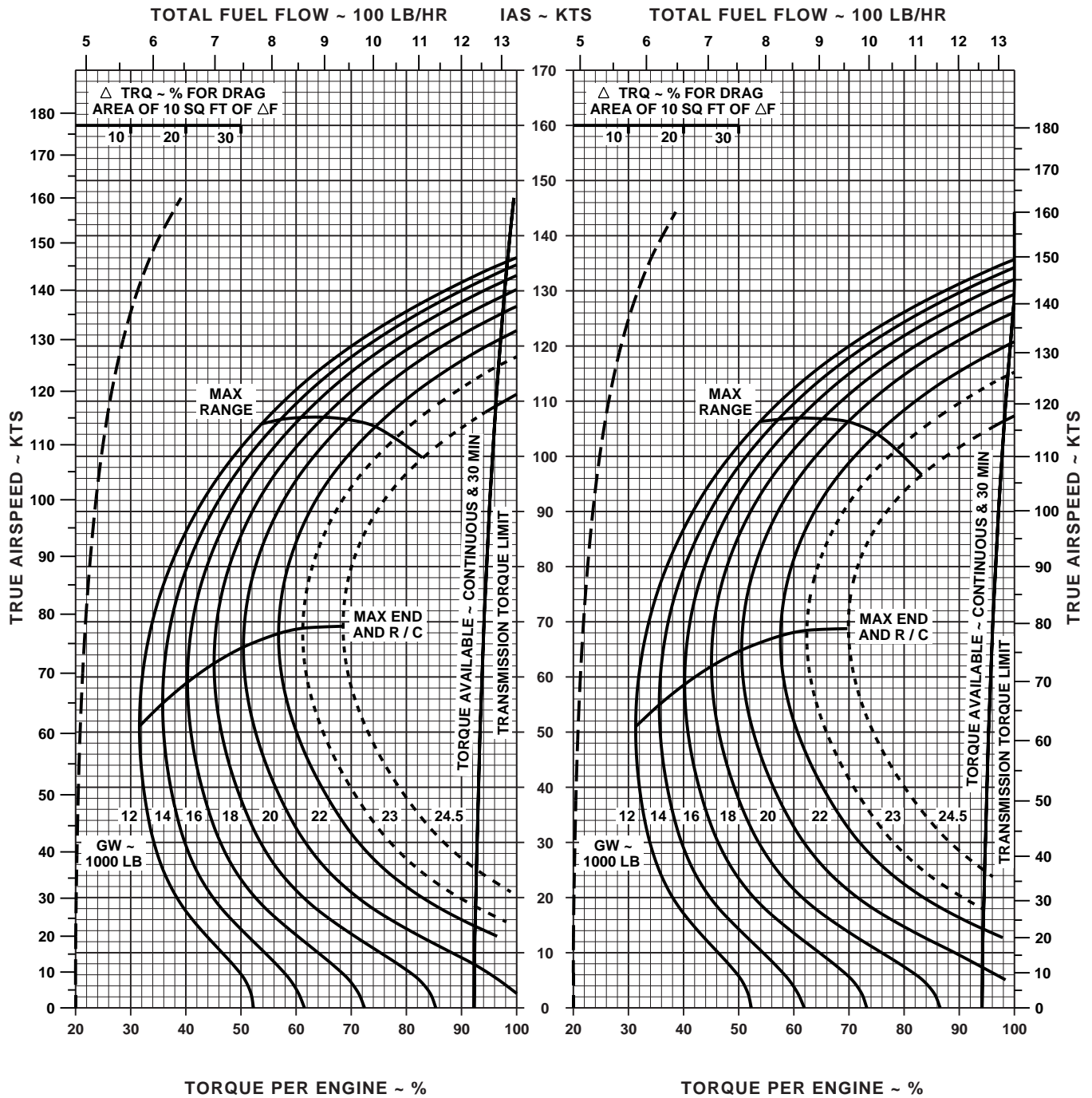

DATA BASE: FLIGHT TEST

AA0553
SA

Figure 7-14. Cruise High Drag - Pressure Altitude 6,000 Feet (Sheet 2 of 6)

CRUISE

PRESS ALT: 6000 FT

CRUISE
6000 FT
T700 (2)



-10°C

0°C

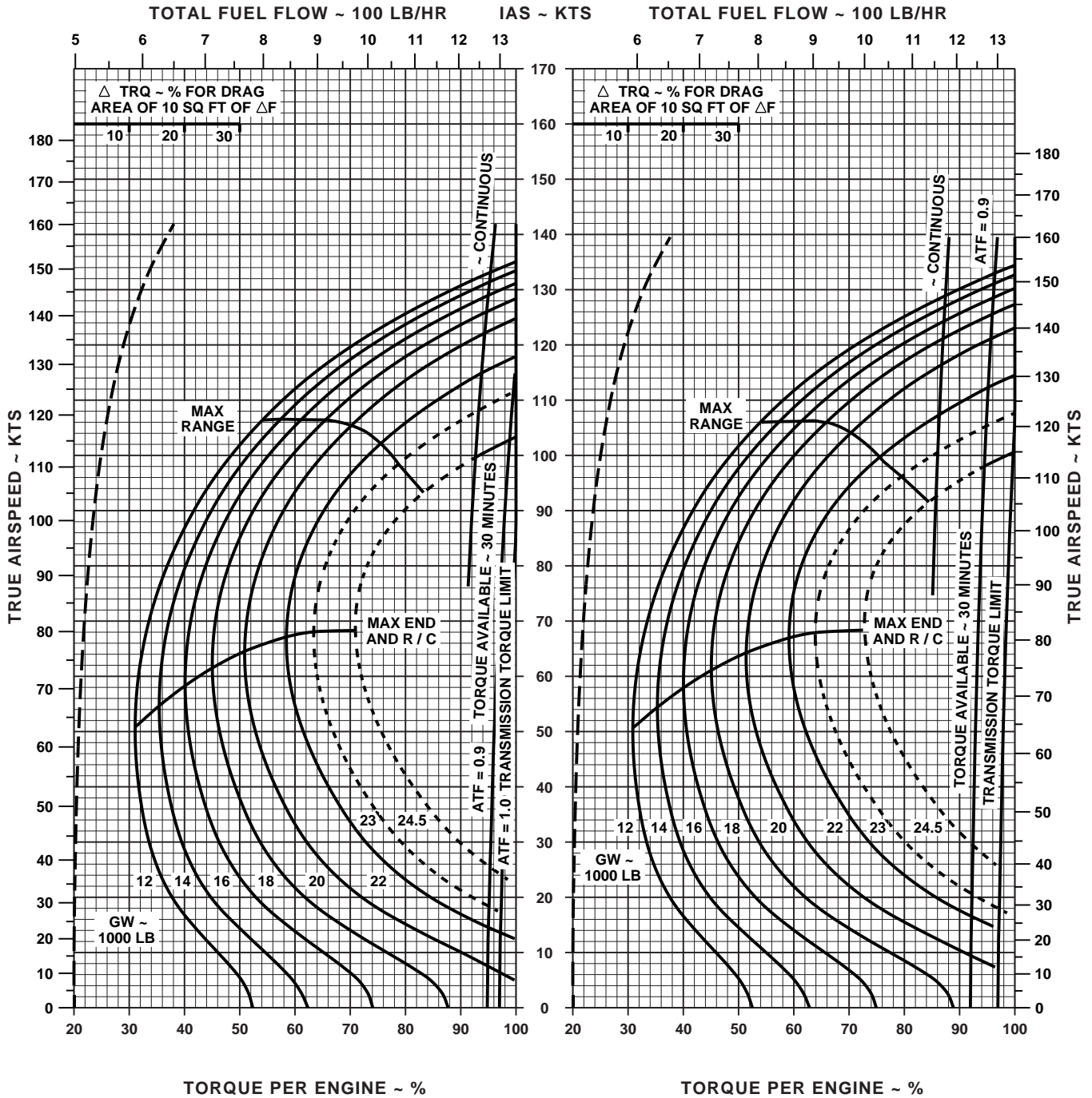

DATA BASE: FLIGHT TEST

AA0554
SA

Figure 7-14. Cruise High Drag - Pressure Altitude 6,000 Feet (Sheet 3 of 6)

CRUISE

PRESS ALT: 6000 FT

CRUISE
6000 FT
T700 (2)



10°C

20°C

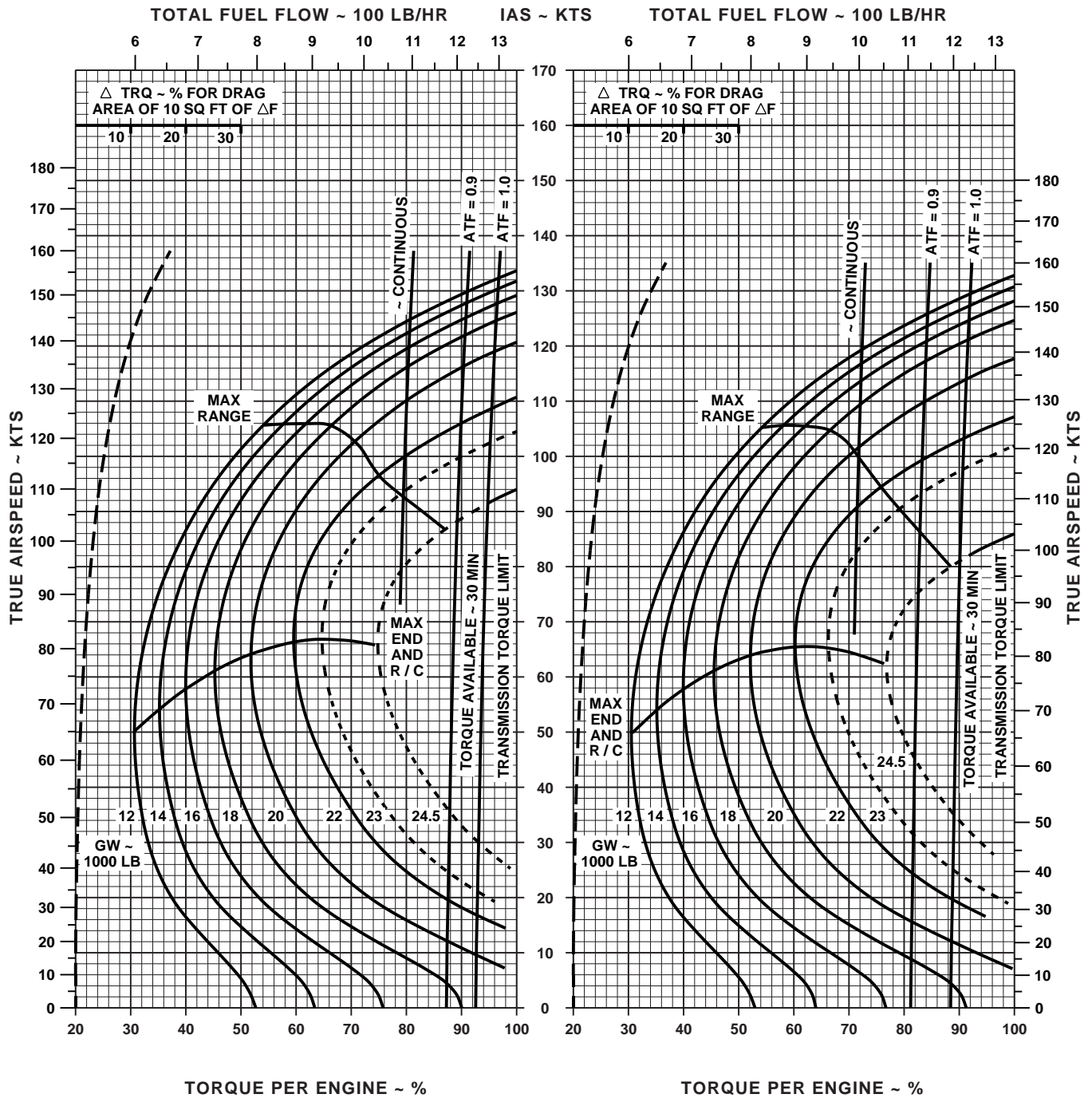

DATA BASE: FLIGHT TEST

AA0555
SA

Figure 7-14. Cruise High Drag - Pressure Altitude 6,000 Feet (Sheet 4 of 6)

CRUISE

PRESS ALT: 6000 FT

CRUISE
6000 FT
T700 (2)



30°C

40°C

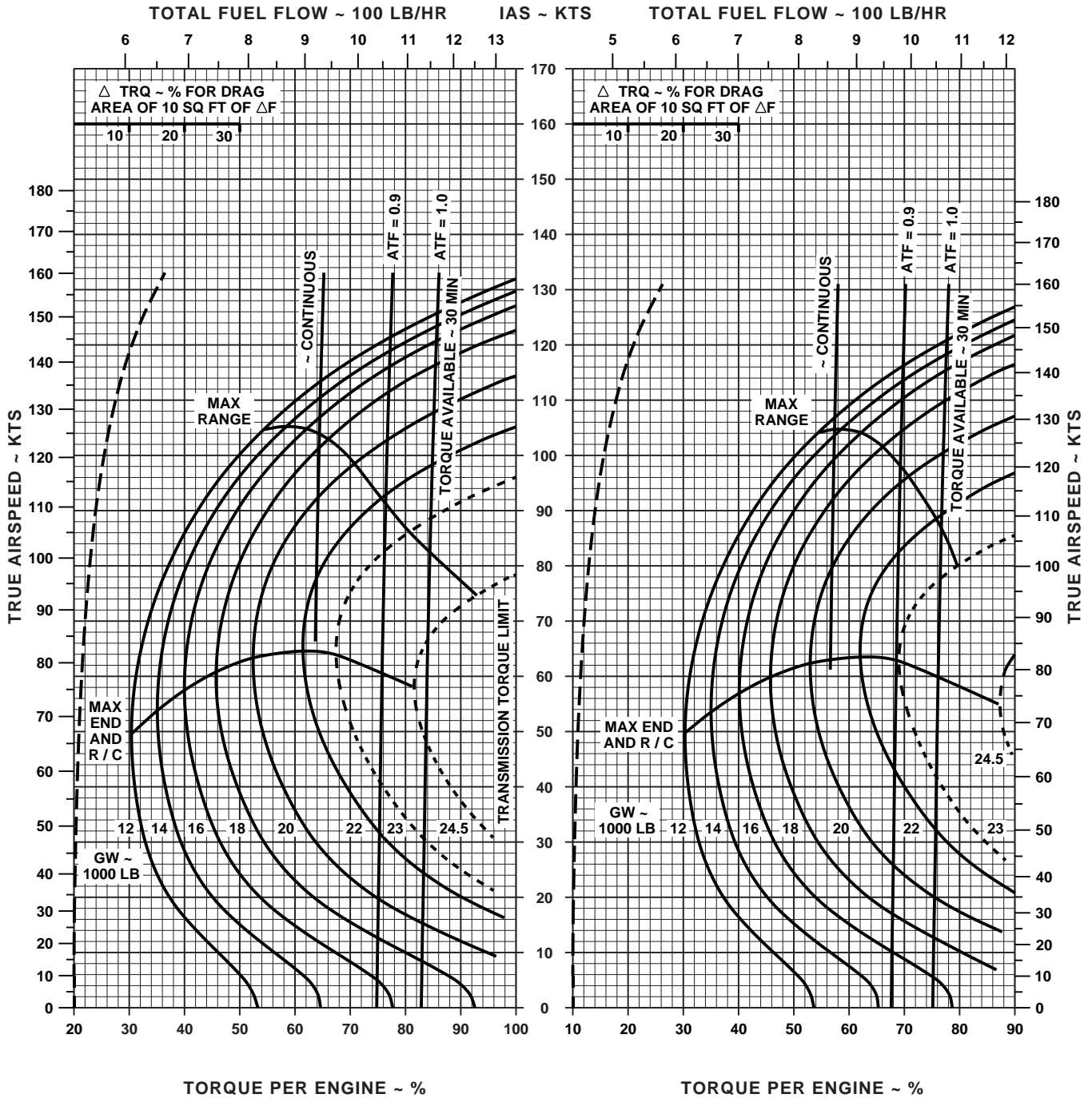

DATA BASIS: FLIGHT TEST

AA0556A
SA

Figure 7-14. Cruise High Drag - Pressure Altitude 6,000 Feet (Sheet 5 of 6)

CRUISE

PRESS ALT: 6000 FT

CRUISE
6000 FT
T700 (2)



50°C

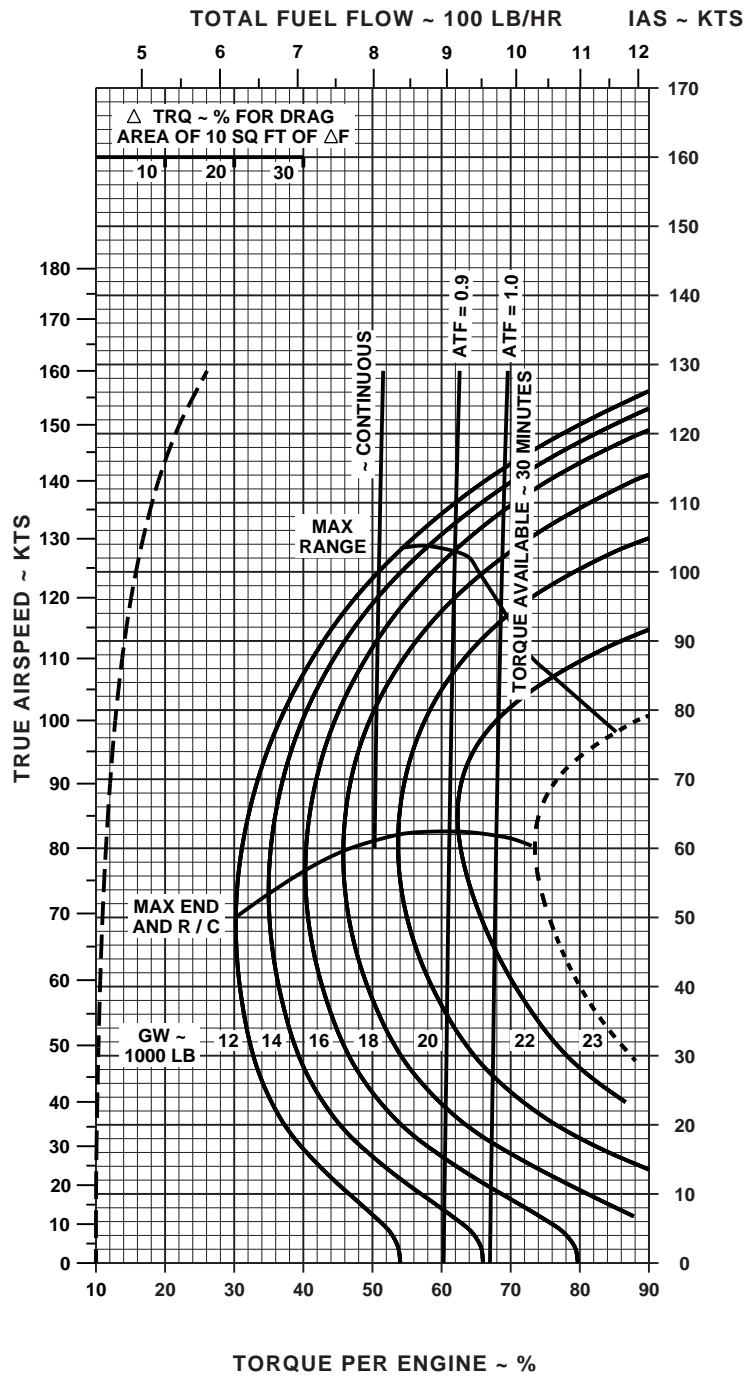

DATA BASE: FLIGHT TEST

AA0557
SA

Figure 7-14. Cruise High Drag - Pressure Altitude 6,000 Feet (Sheet 6 of 6)

CRUISE

CLEAN CONFIGURATION

PRESS ALT: 8000 FT

CRUISE
8000 FT
T700 (2)

-50°C

-40°C

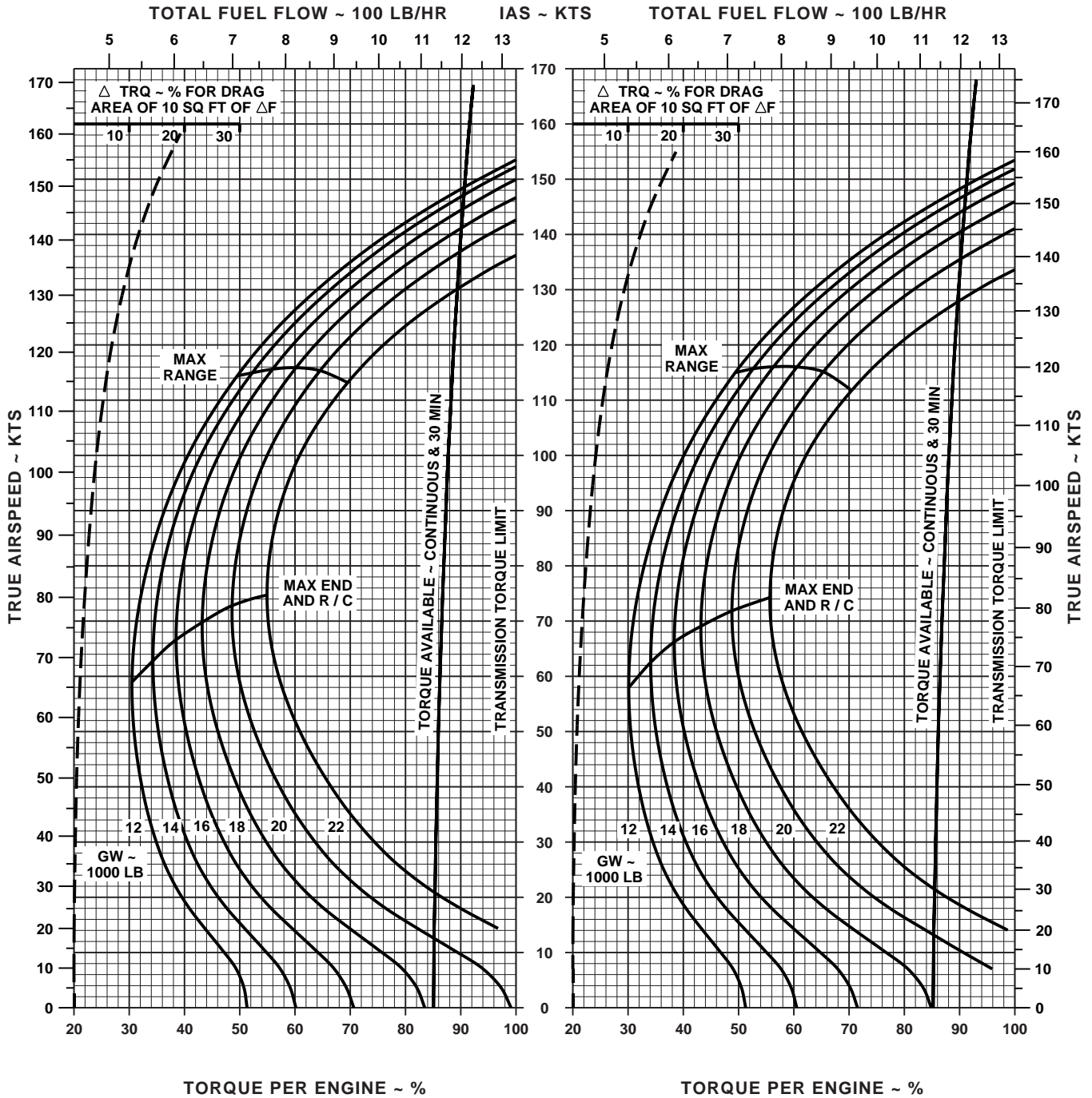

DATA BASE: FLIGHT TEST

AA0467
SA

Figure 7-15. Cruise - Pressure Altitude 8,000 Feet (Sheet 1 of 6)

CRUISE

CLEAN CONFIGURATION

PRESS ALT: 8000 FT

CRUISE
8000 FT
T700 (2)

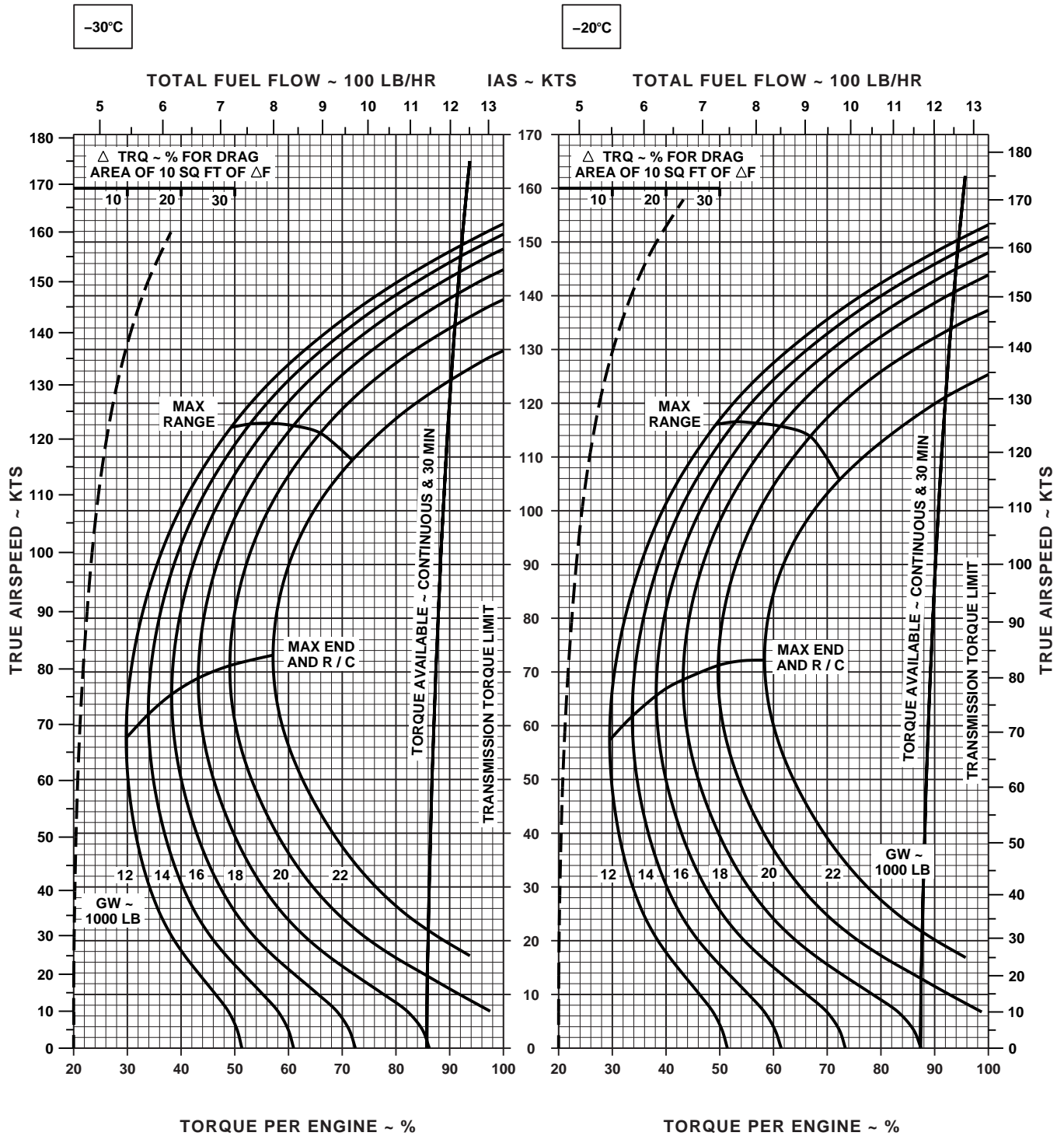

DATA BASE: FLIGHT TEST

AA0466
SA

Figure 7-15. Cruise - Pressure Altitude 8,000 Feet (Sheet 2 of 6)

CRUISE

CLEAN CONFIGURATION

PRESS ALT: 8000 FT

CRUISE
8000 FT
T700 (2)

-10°C

0°C

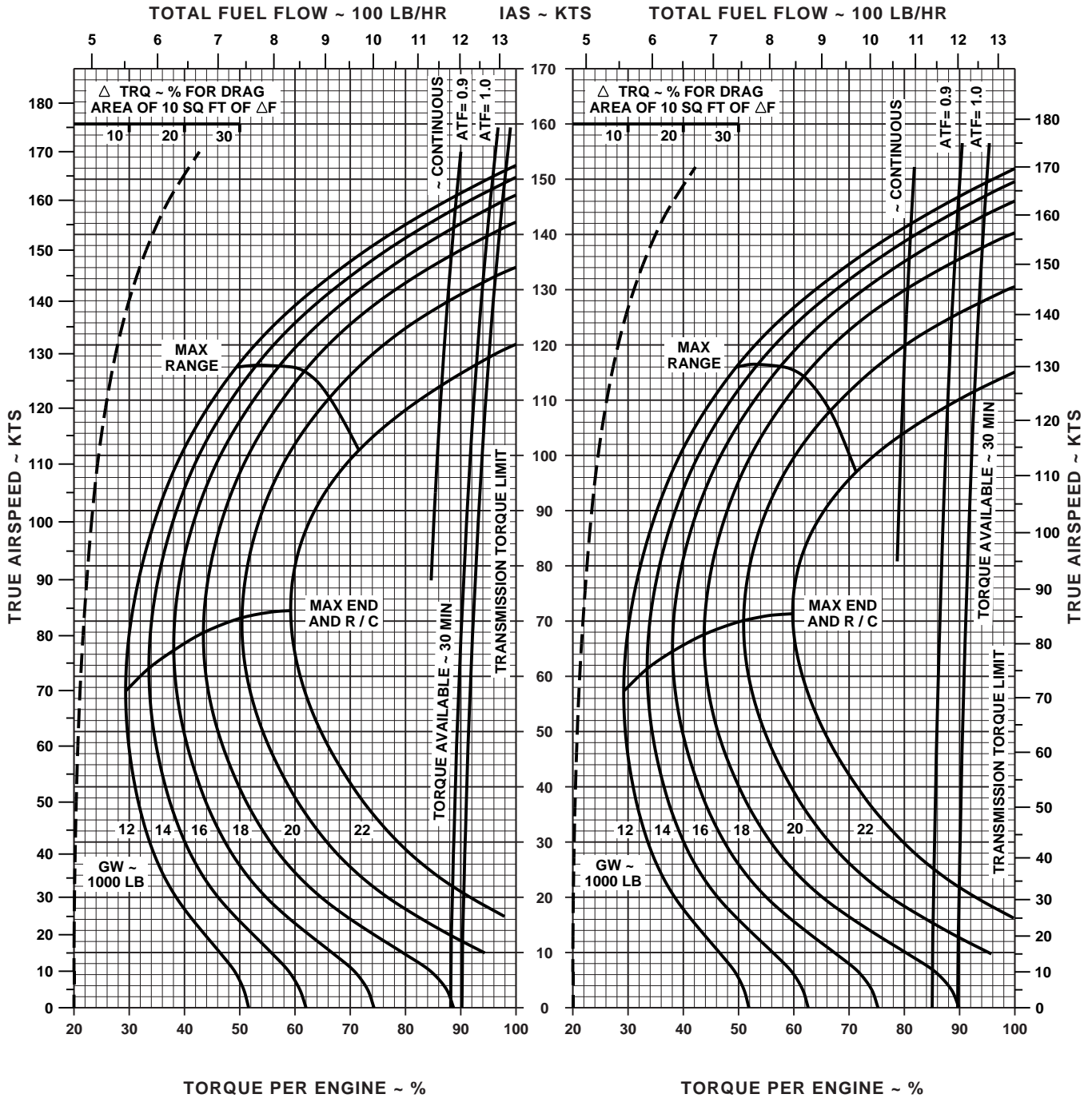

DATA BASE: FLIGHT TEST

AA0465
SA

Figure 7-15. Cruise - Pressure Altitude 8,000 Feet (Sheet 3 of 6)

CRUISE

CLEAN CONFIGURATION

PRESS ALT: 8000 FT

CRUISE
8000 FT
T700 (2)

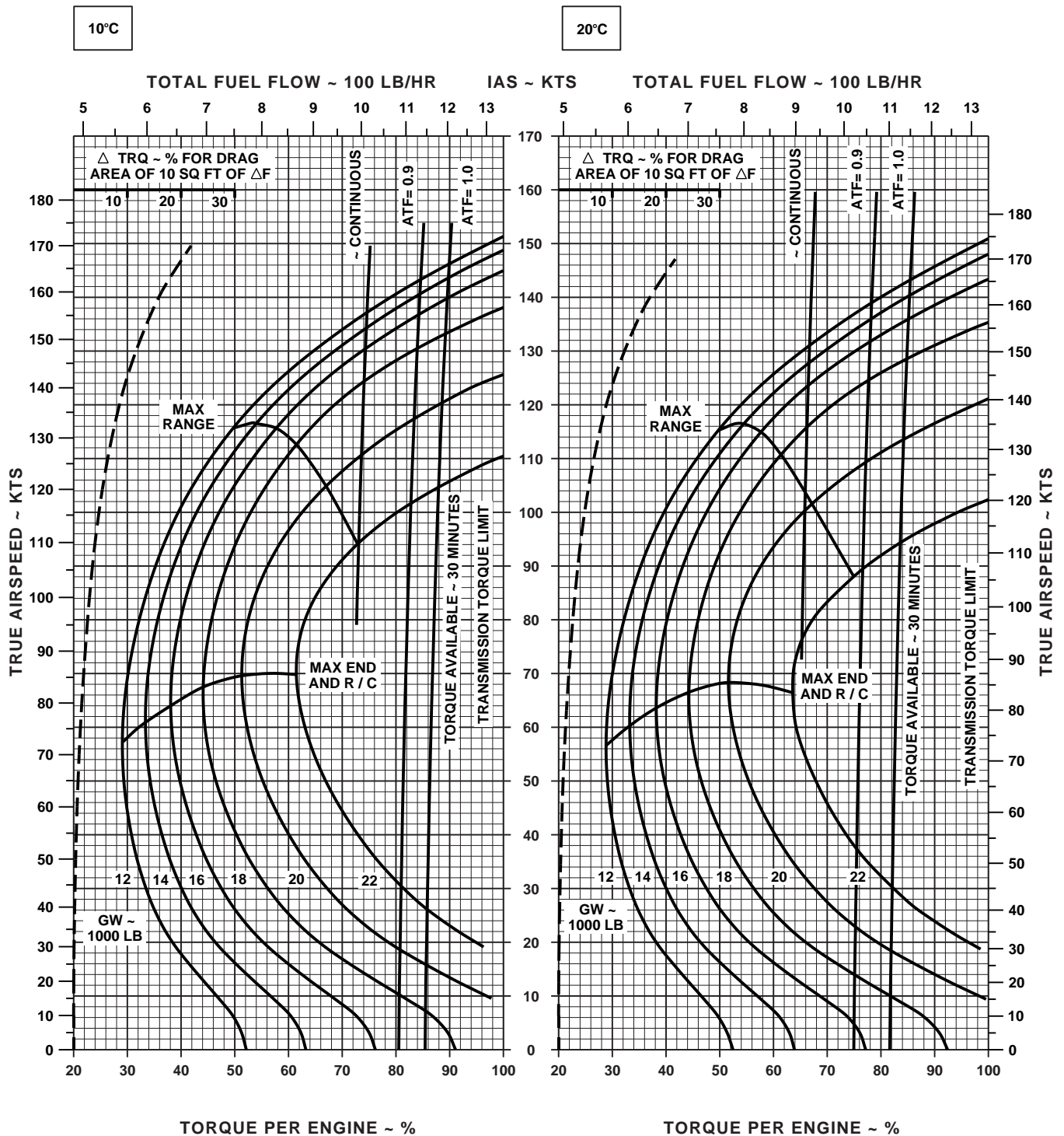

DATA BASE: FLIGHT TEST

AA0468
SA

Figure 7-15. Cruise - Pressure Altitude 8,000 Feet (Sheet 4 of 6)

CRUISE

CLEAN CONFIGURATION

PRESS ALT: 8000 FT

CRUISE
8000 FT
T700 (2)

30°C

40°C

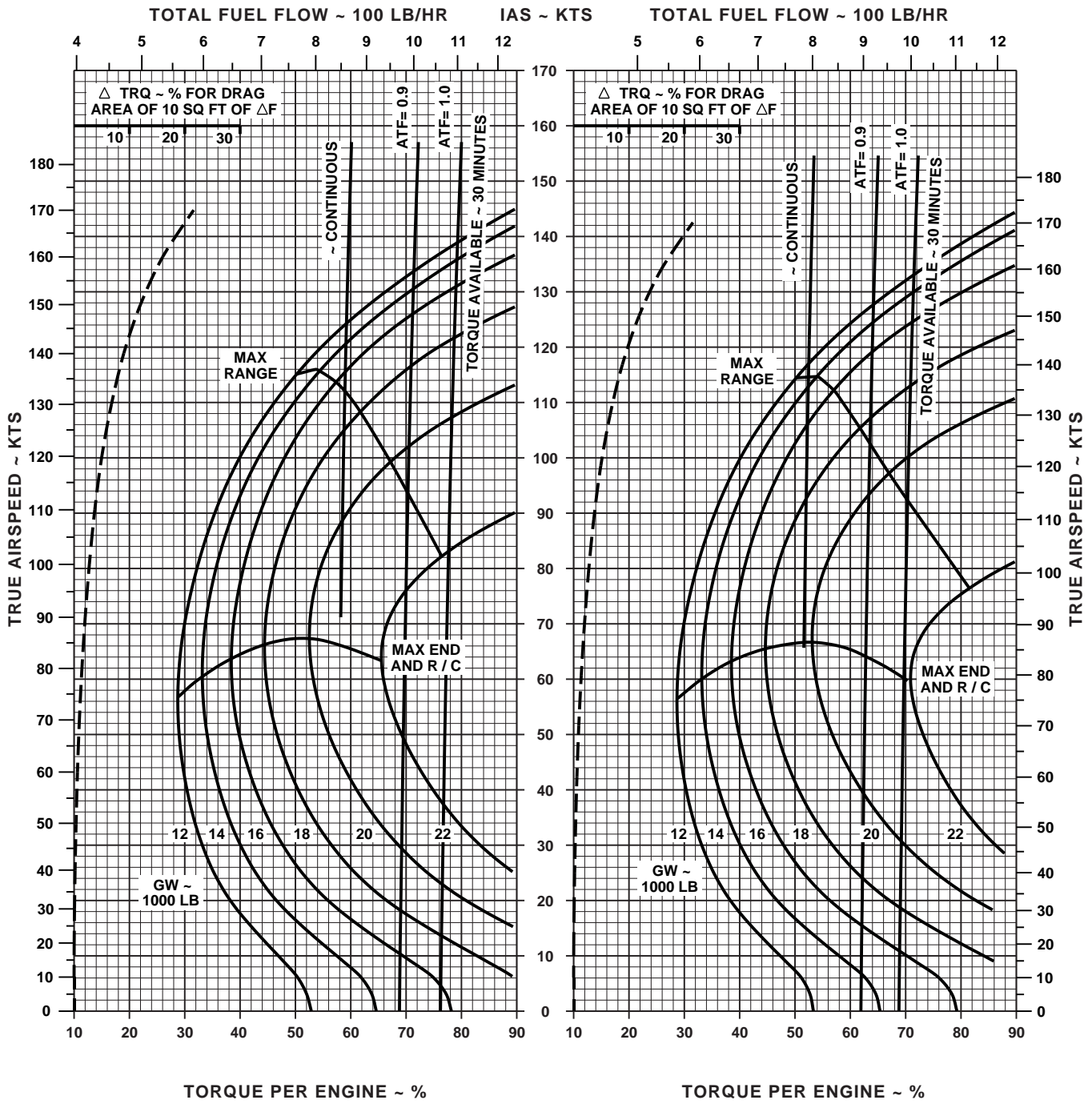

DATA BASIS: FLIGHT TEST

AA0469A
SA

Figure 7-15. Cruise - Pressure Altitude 8,000 Feet (Sheet 5 of 6)

CRUISE

CLEAN CONFIGURATION

PRESS ALT: 8000 FT

CRUISE
8000 FT
T700 (2)

50°C

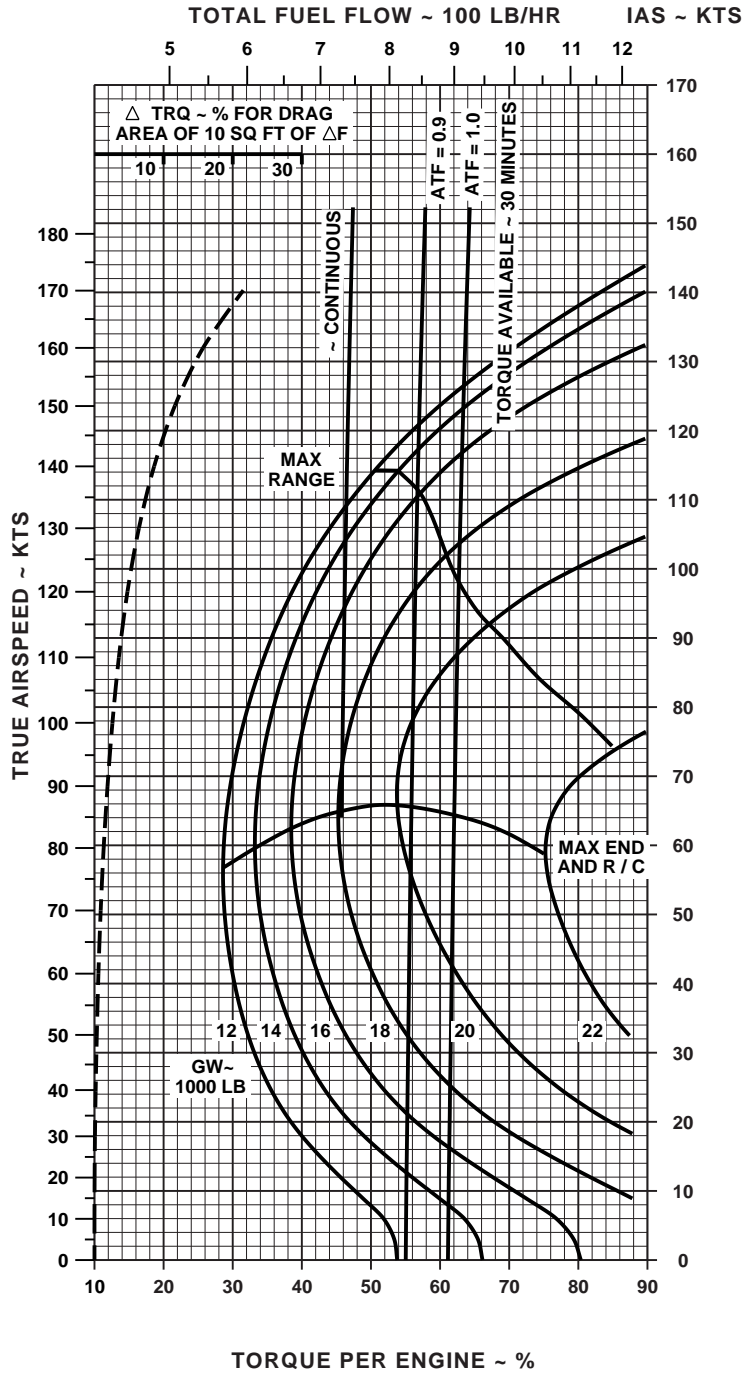

DATA BASE: FLIGHT TEST

AA0470
SA

Figure 7-15. Cruise - Pressure Altitude 8,000 Feet (Sheet 6 of 6)

CRUISE

PRESS ALT: 8000 FT

CRUISE
8000 FT
T700 (2)



-50°C

-40°C

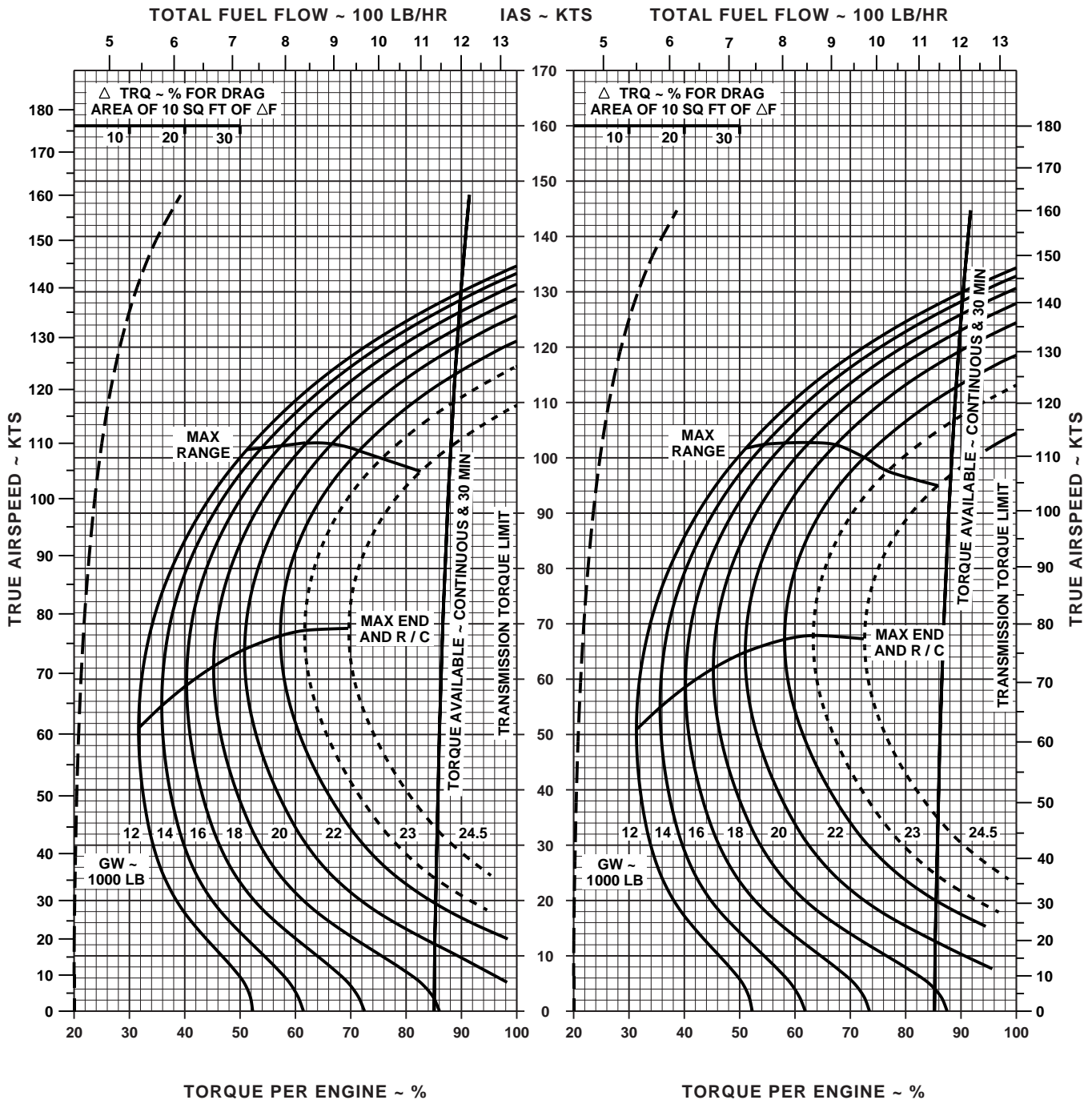

DATA BASE: FLIGHT TEST

AA0558
SA

Figure 7-16. Cruise High Drag - Pressure Altitude 8,000 Feet (Sheet 1 of 6)

CRUISE

PRESS ALT: 8000 FT

CRUISE
8000 FT
T700 (2)



-30°C

-20°C

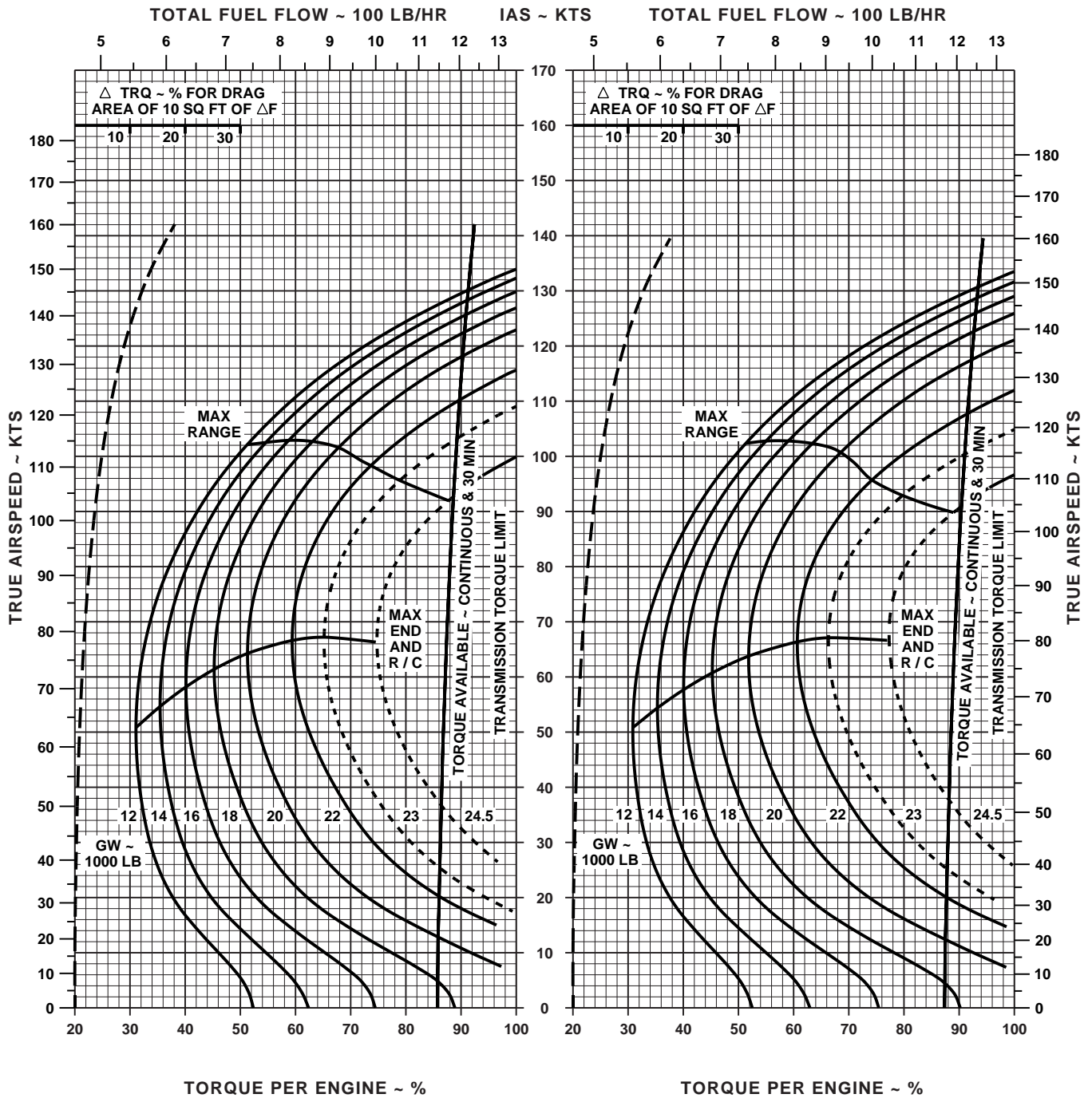

DATA BASE: FLIGHT TEST

AA0559
SA

Figure 7-16. Cruise High Drag - Pressure Altitude 8,000 Feet (Sheet 2 of 6)

CRUISE

PRESS ALT: 8000 FT

CRUISE
8000 FT
T700 (2)



-10°C

0°C

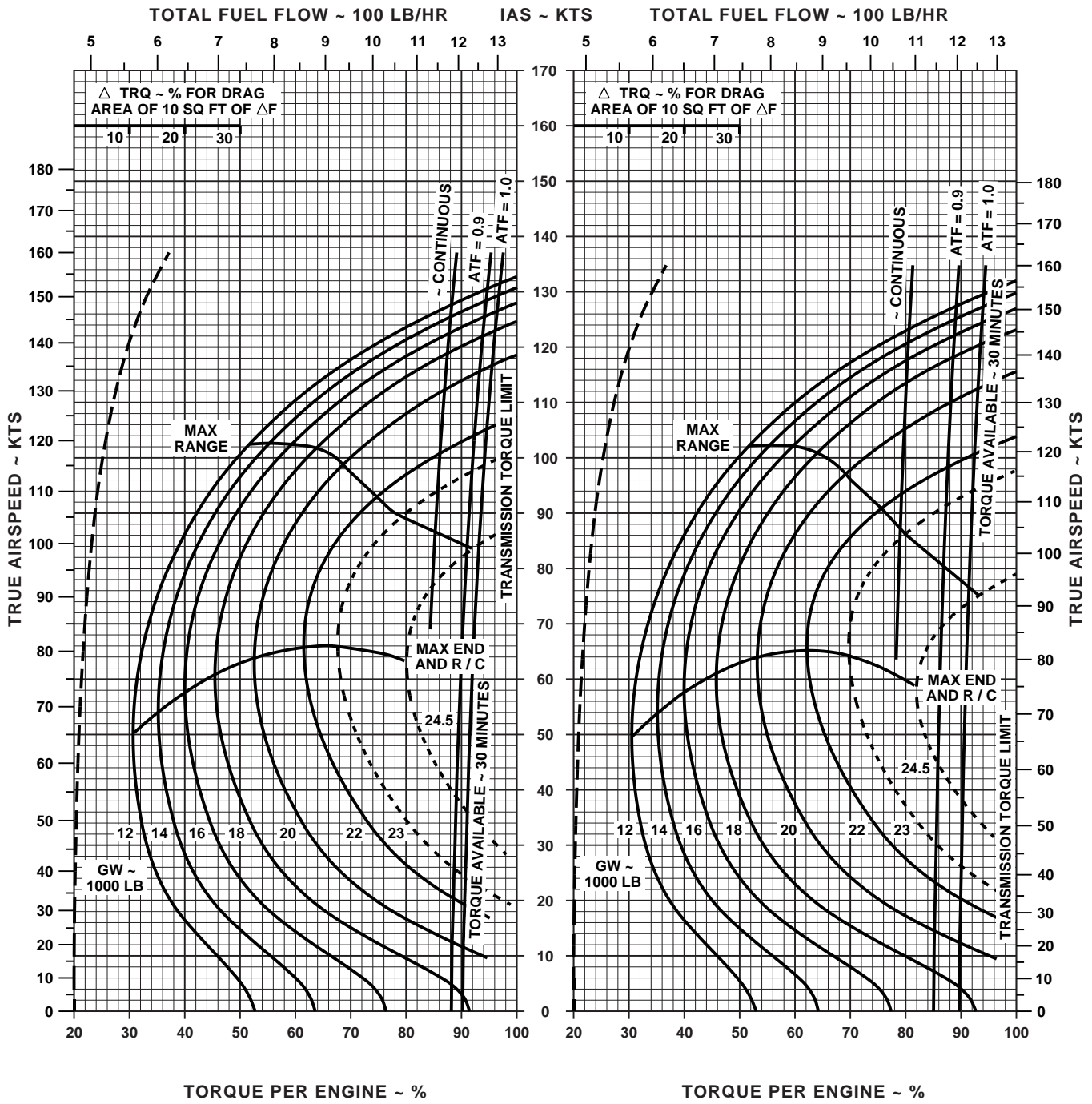

DATA BASE: FLIGHT TEST

AA0560
SA

Figure 7-16. Cruise High Drag - Pressure Altitude 8,000 Feet (Sheet 3 of 6)

CRUISE

PRESS ALT: 8000 FT

CRUISE
8000 FT
T700 (2)



10°C

20°C

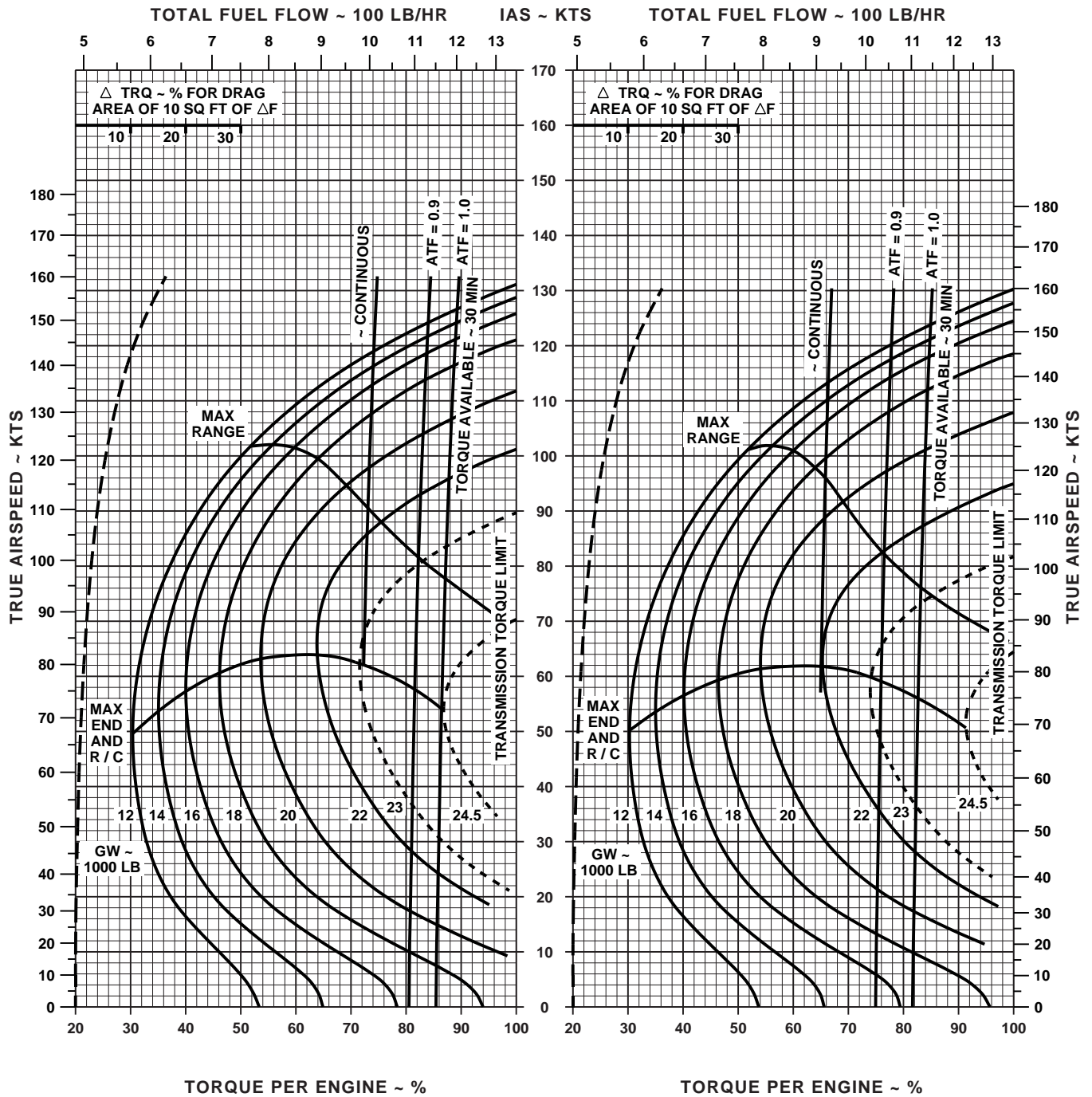

DATA BASE: FLIGHT TEST

AA0561
SA

Figure 7-16. Cruise High Drag - Pressure Altitude 8,000 Feet (Sheet 4 of 6)

CRUISE

PRESS ALT: 8000 FT

CRUISE
8000 FT
T700 (2)



30°C

40°C

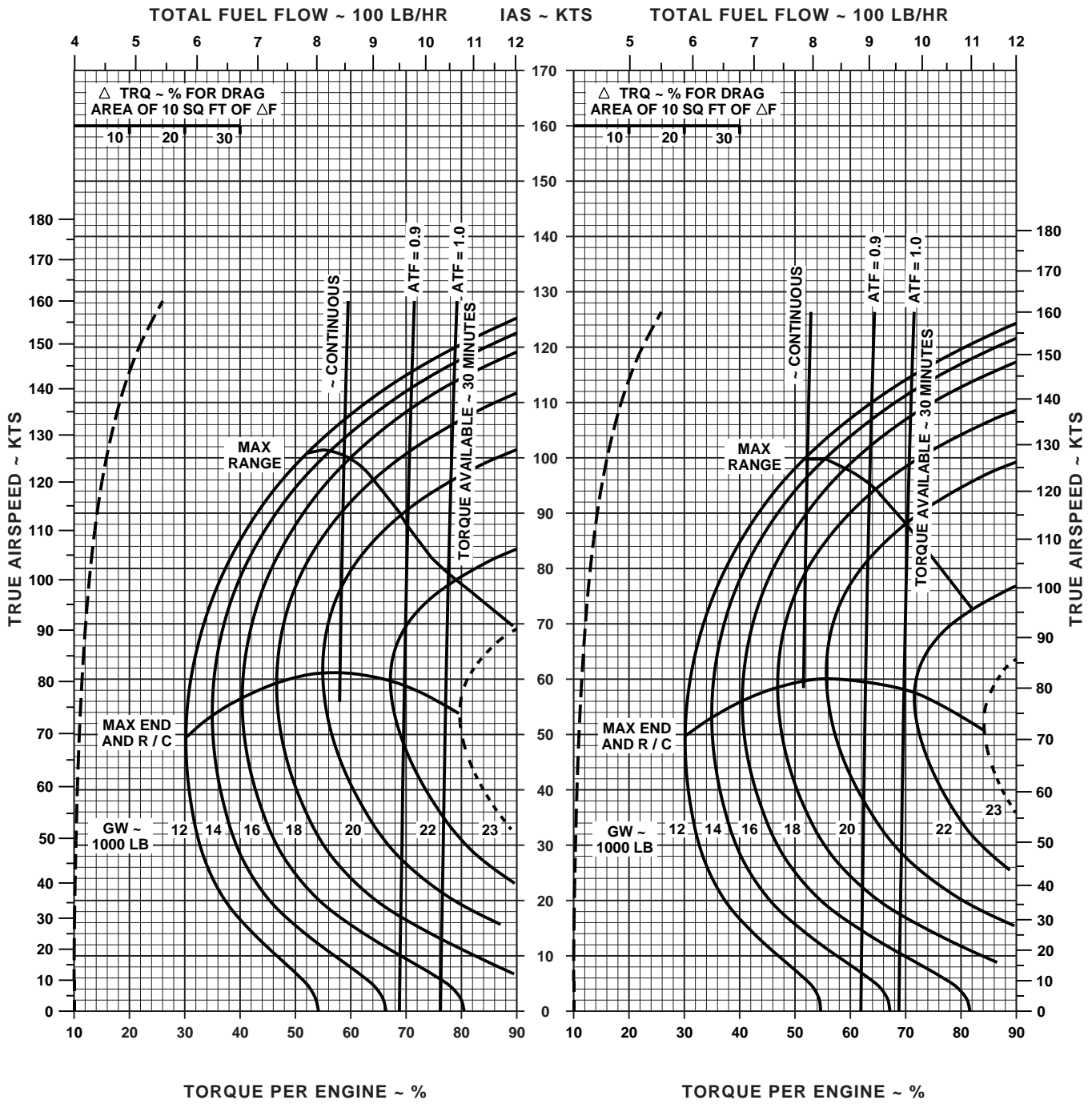

DATA BASE: FLIGHT TEST

AA0562
SA

Figure 7-16. Cruise High Drag - Pressure Altitude 8,000 Feet (Sheet 5 of 6)

CRUISE

PRESS ALT: 8000 FT

CRUISE
8000 FT
T700 (2)



50°C

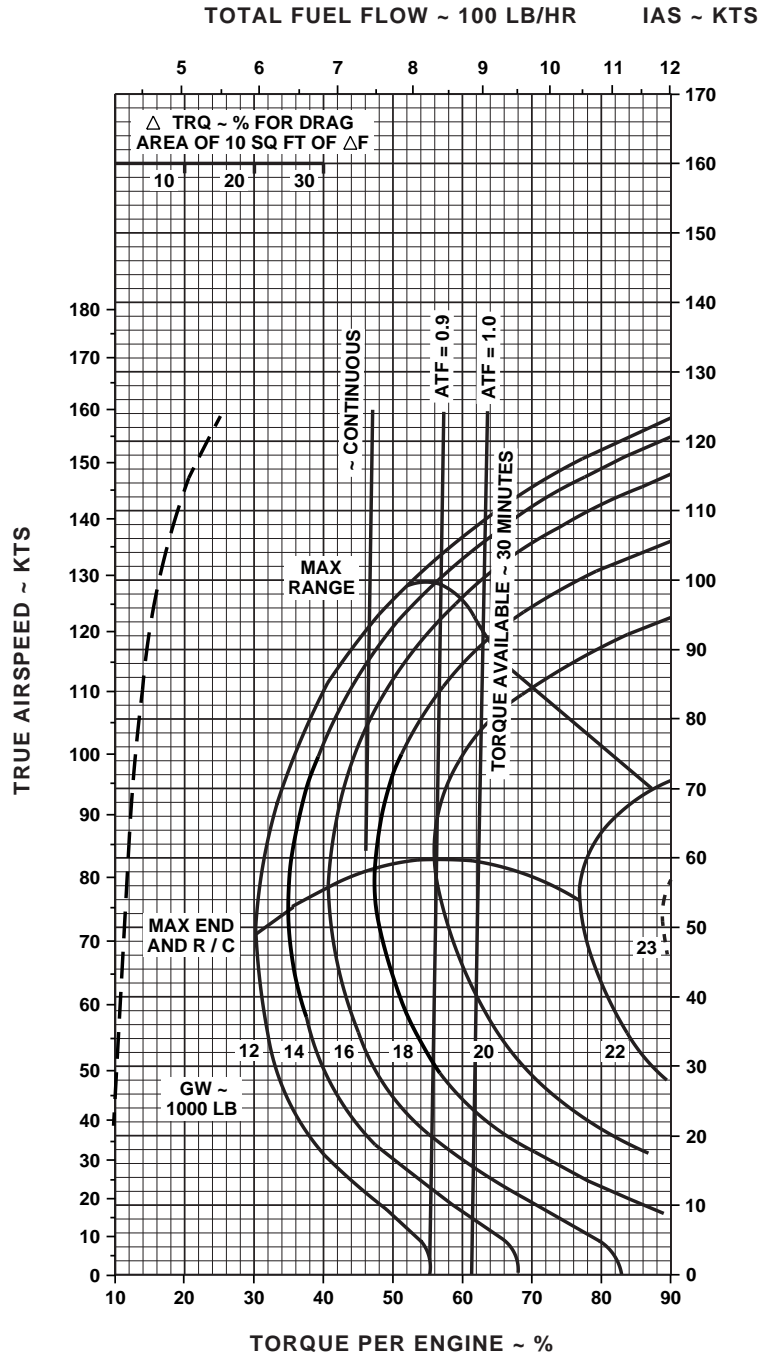

DATA BASE: FLIGHT TEST

AA0563
SA

Figure 7-16. Cruise High Drag - Pressure Altitude 8,000 Feet (Sheet 6 of 6)

CRUISE

CLEAN CONFIGURATION PRESS ALT: 10000 FT

CRUISE
10000 FT
T700 (2)

-50°C

-40°C

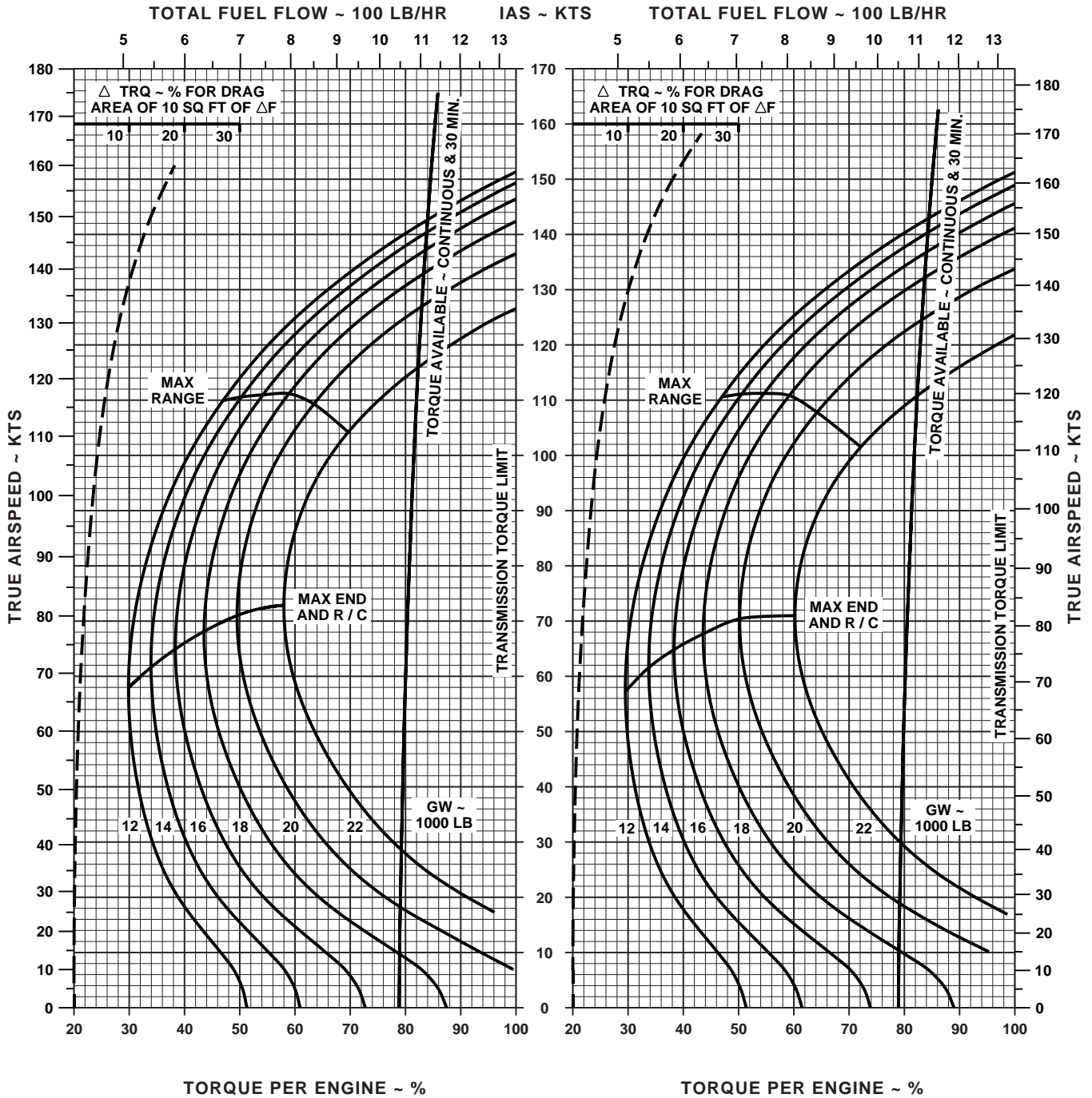

DATA BASE: FLIGHT TEST

AA0420
SA

Figure 7-17. Cruise - Pressure Altitude 10,000 Feet (Sheet 1 of 5)

CRUISE

CLEAN CONFIGURATION

PRESS ALT: 10000 FT

CRUISE
10000 FT
T700 (2)

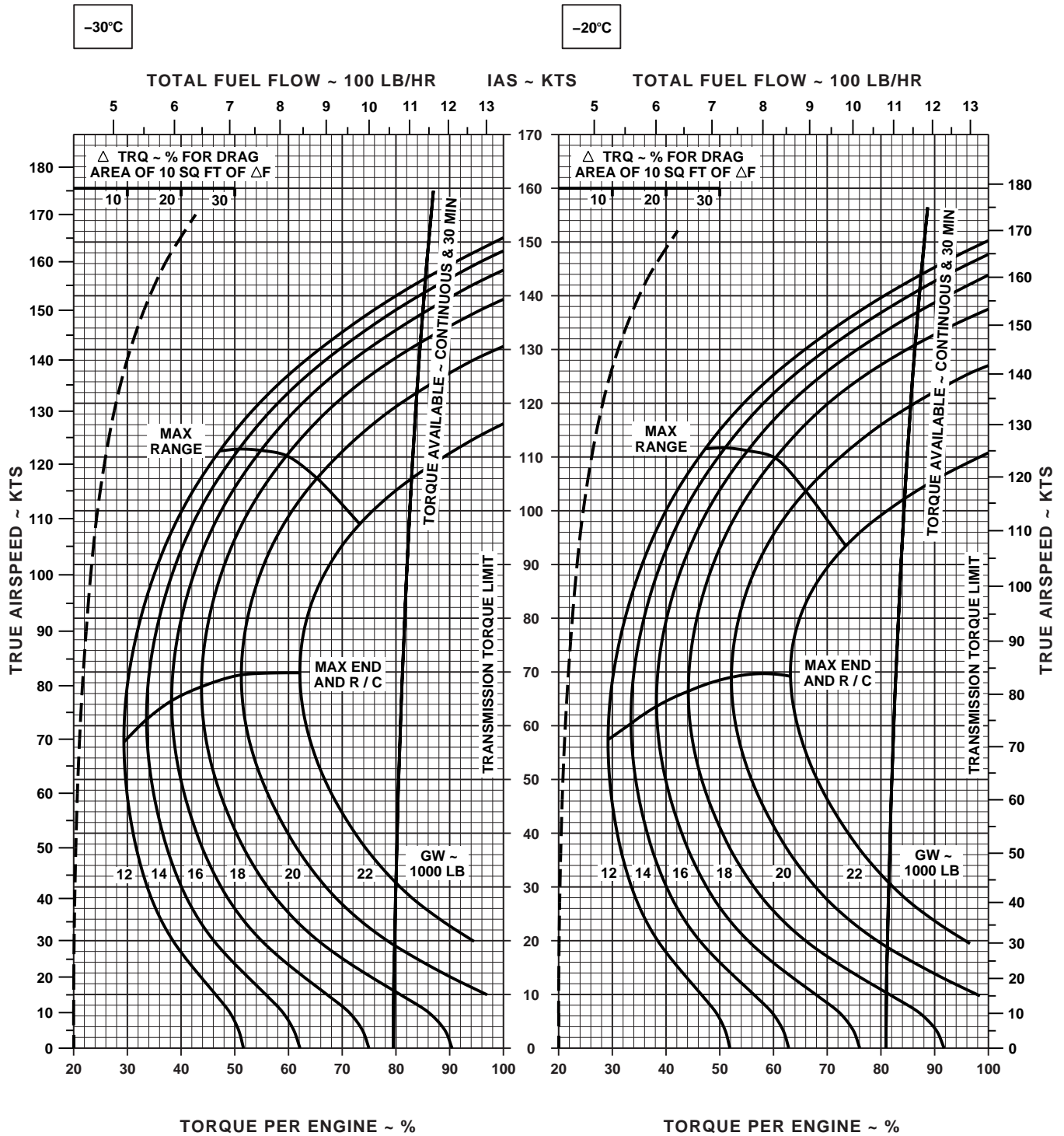

DATA BASE: FLIGHT TEST

AA0419
SA

Figure 7-17. Cruise - Pressure Altitude 10,000 Feet (Sheet 2 of 5)

CRUISE

CLEAN CONFIGURATION

PRESS ALT: 10000 FT

CRUISE
10000 FT
T700 (2)

-10°C

0°C

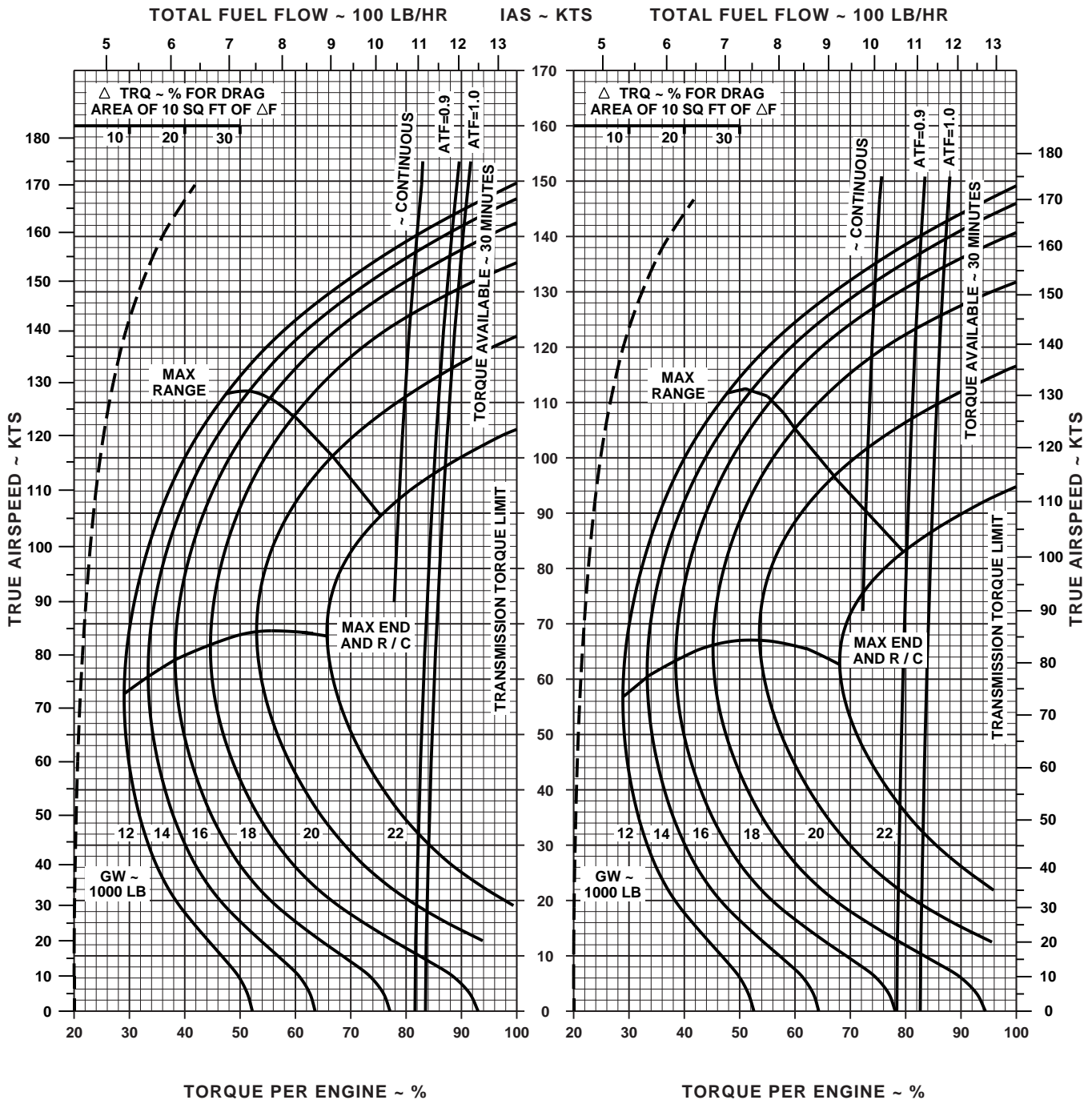

DATA BASE: FLIGHT TEST

AA0418
SA

Figure 7-17. Cruise - Pressure Altitude 10,000 Feet (Sheet 3 of 5)

CRUISE

CLEAN CONFIGURATION

PRESS ALT: 10000 FT

CRUISE
10000 FT
T700 (2)

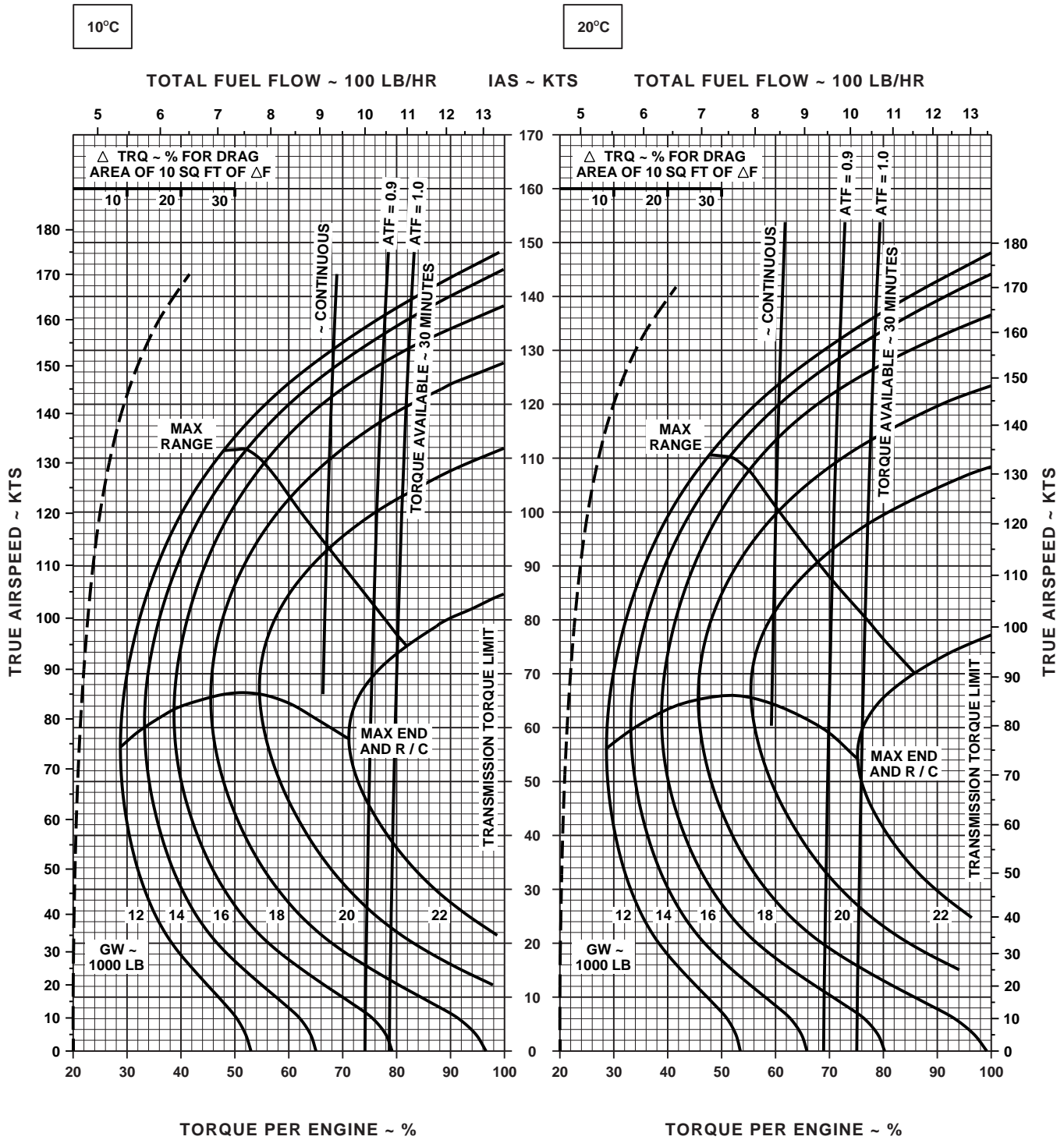

DATA BASE: FLIGHT TEST

AA0421
SA

Figure 7-17. Cruise - Pressure Altitude 10,000 Feet (Sheet 4 of 5)

CRUISE

CLEAN CONFIGURATION PRESS ALT: 10000 FT

CRUISE
10000 FT
T700 (2)

30°C

40°C

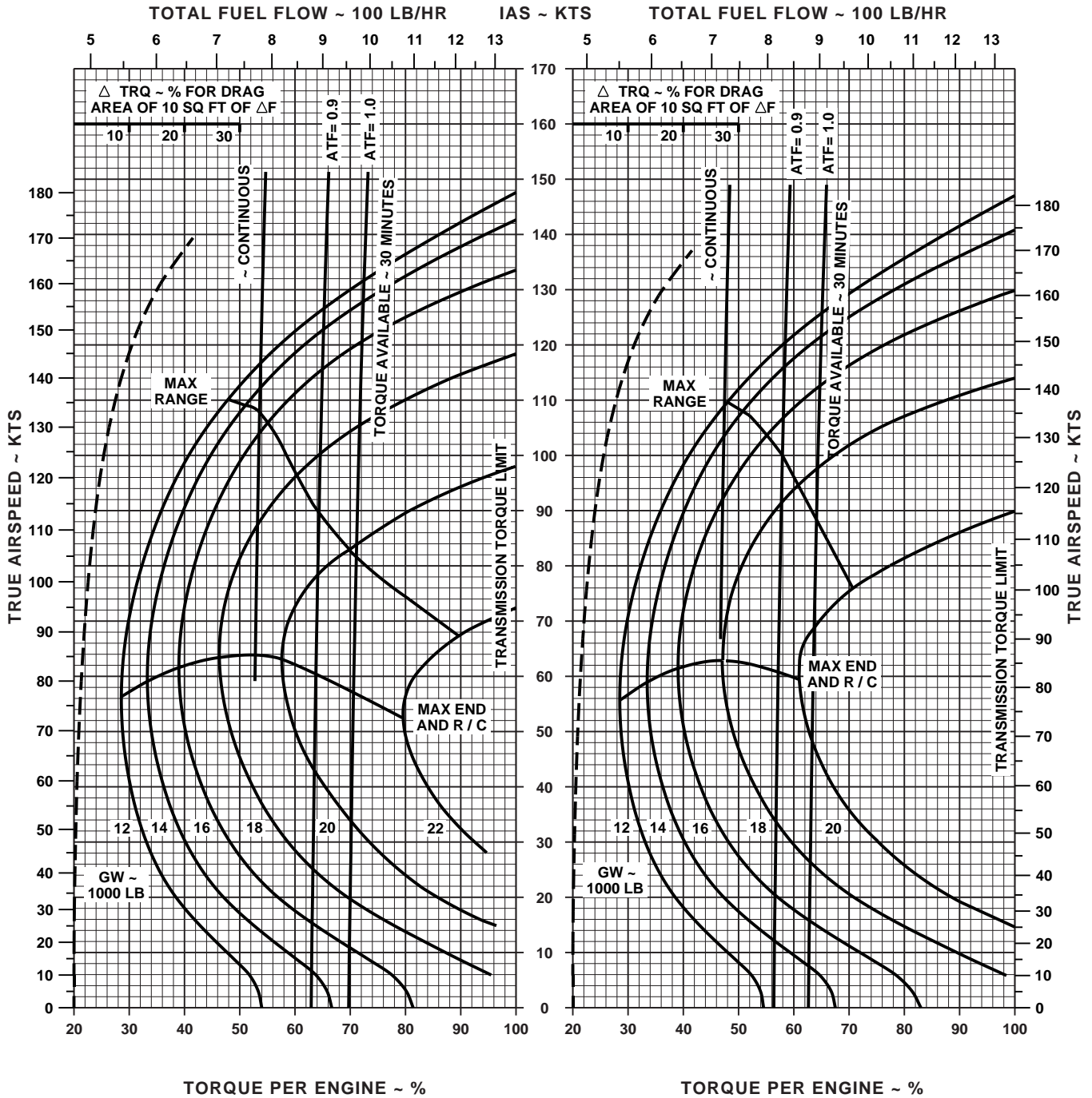

DATA BASE: FLIGHT TEST

AA0422
SA

Figure 7-17. Cruise - Pressure Altitude 10,000 Feet (Sheet 5 of 5)

CRUISE

PRESS ALT: 10000 FT

CRUISE
10000 FT
T700 (2)



-50°C

-40°C

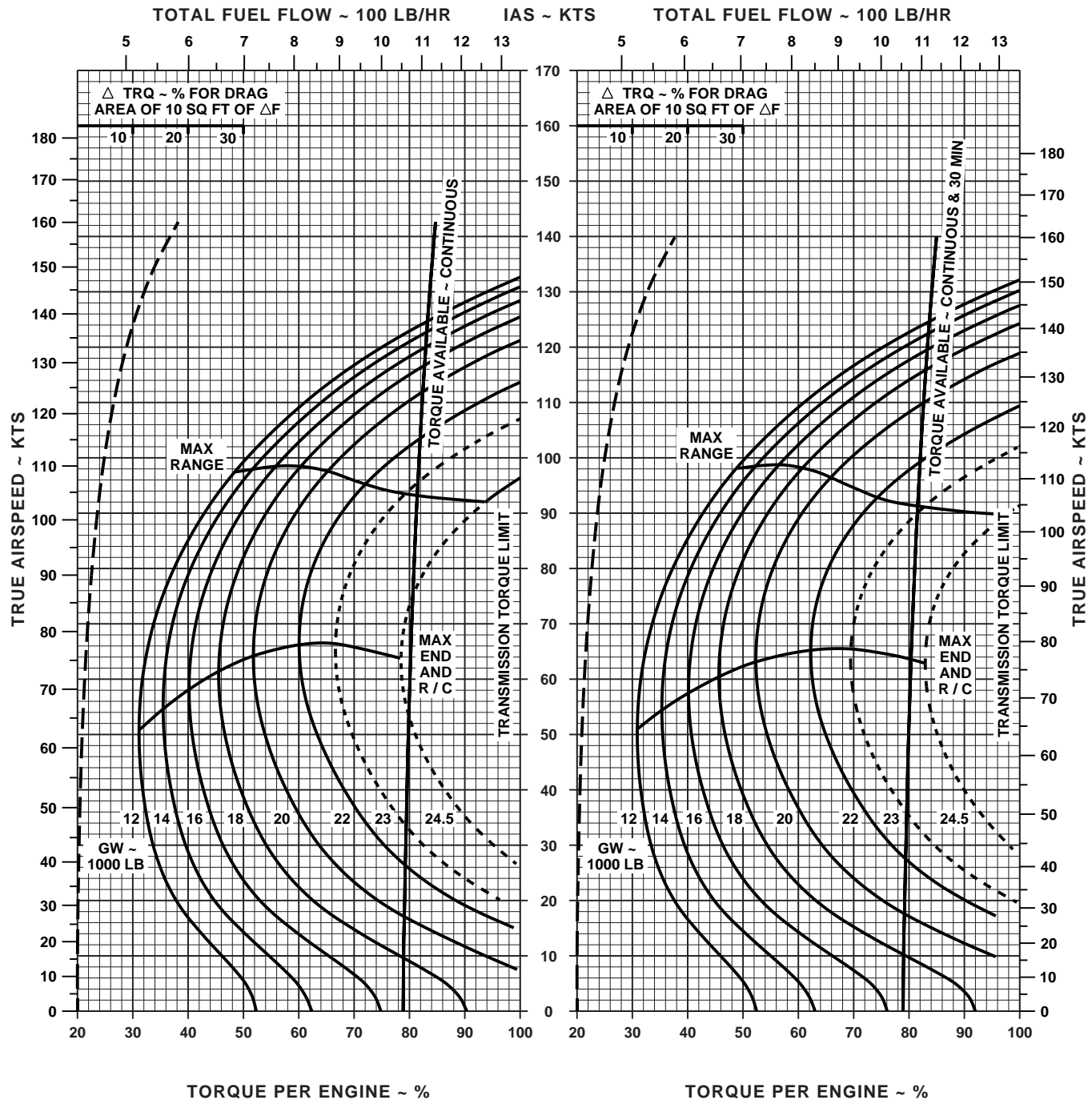

DATA BASE: FLIGHT TEST

AA0564 SA

Figure 7-18. Cruise High Drag - Pressure Altitude 10,000 Feet (Sheet 1 of 5)

CRUISE

PRESS ALT: 10000 FT

CRUISE
10000 FT
T700 (2)



-30°C

-20°C

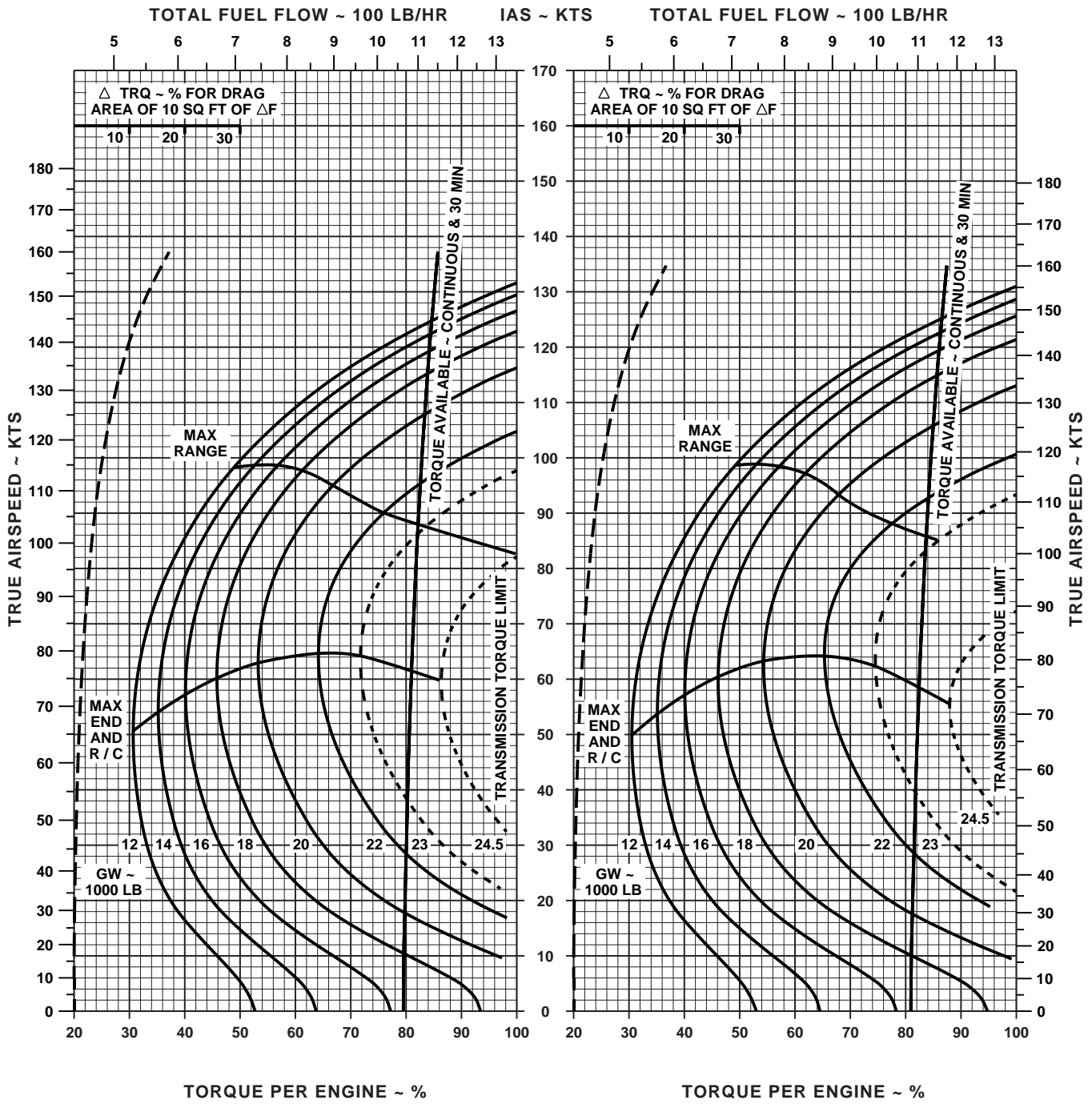

DATA BASE: FLIGHT TEST

AA0565
SA

Figure 7-18. Cruise High Drag - Pressure Altitude 10,000 Feet (Sheet 2 of 5)

CRUISE

PRESS ALT: 10000 FT

CRUISE
10000 FT
T700 (2)



-10°C

0°C

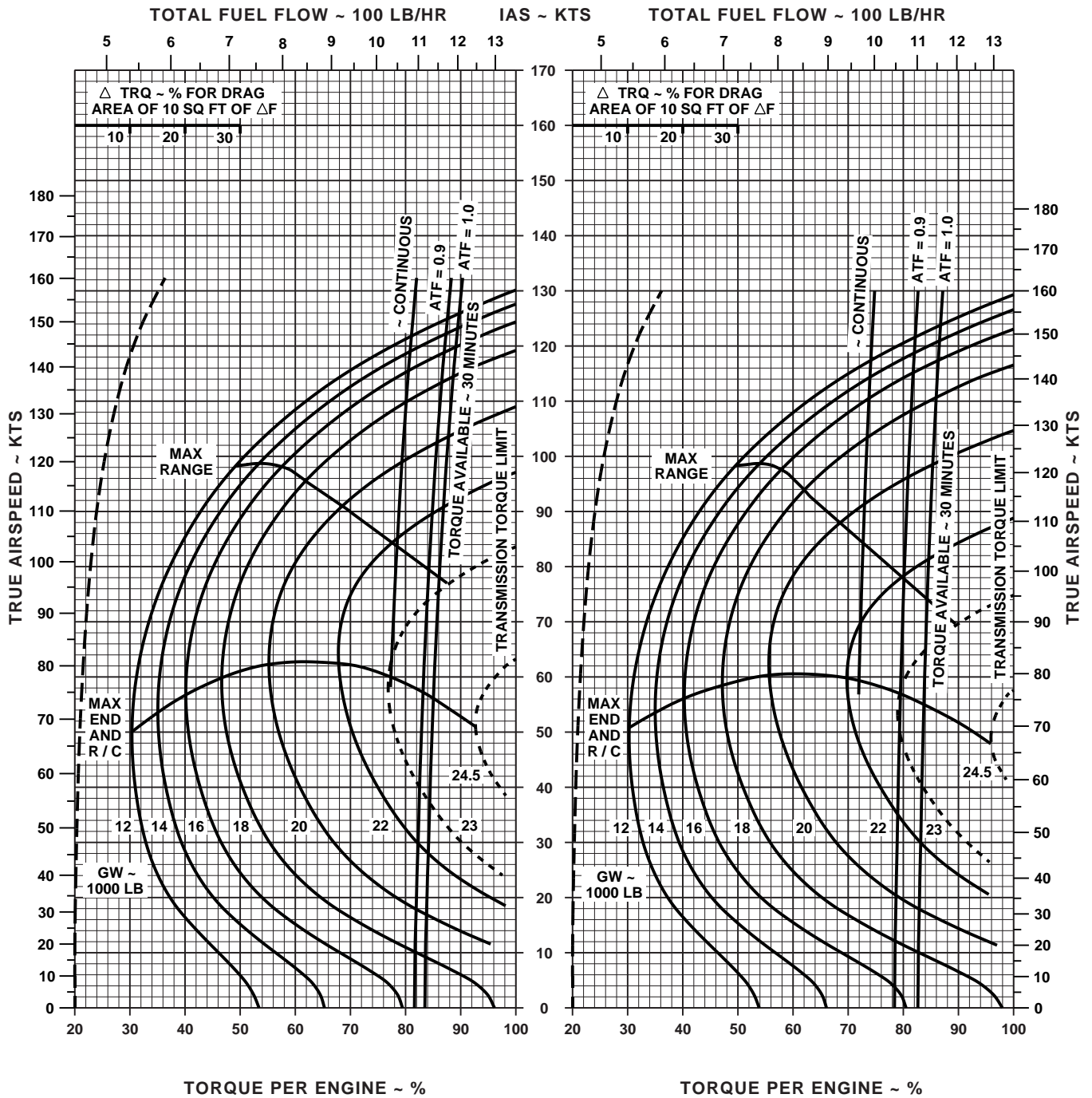

DATA BASE: FLIGHT TEST

AA0566
SA

Figure 7-18. Cruise High Drag - Pressure Altitude 10,000 Feet (Sheet 3 of 5)

CRUISE

PRESS ALT: 10000 FT

CRUISE
10000 FT
T700 (2)



10°C

20°C

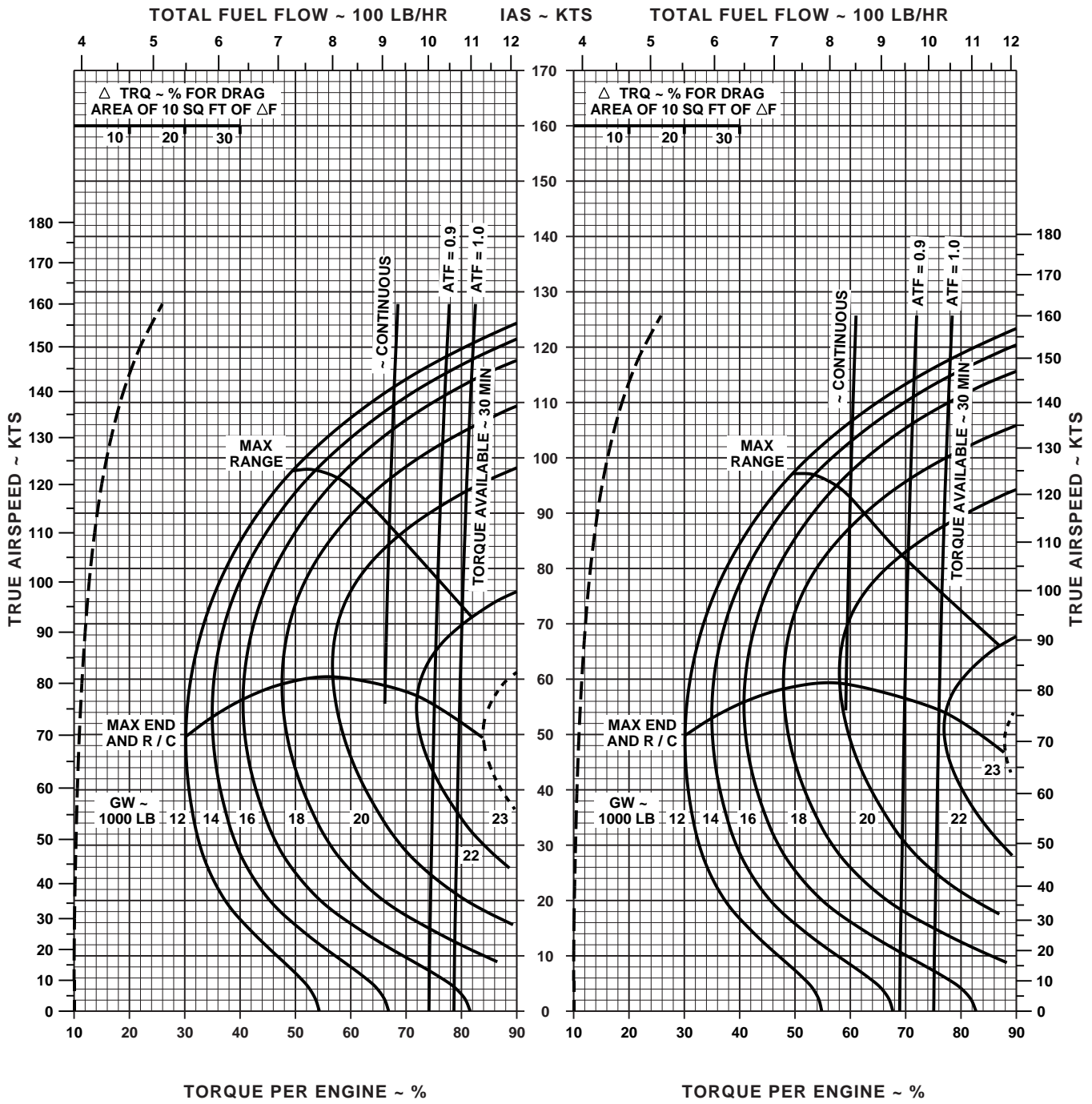

DATA BASE: FLIGHT TEST

AA0567
SA

Figure 7-18. Cruise High Drag - Pressure Altitude 10,000 Feet (Sheet 4 of 5)

CRUISE

PRESS ALT: 10000 FT

CRUISE
10000 FT
T700 (2)



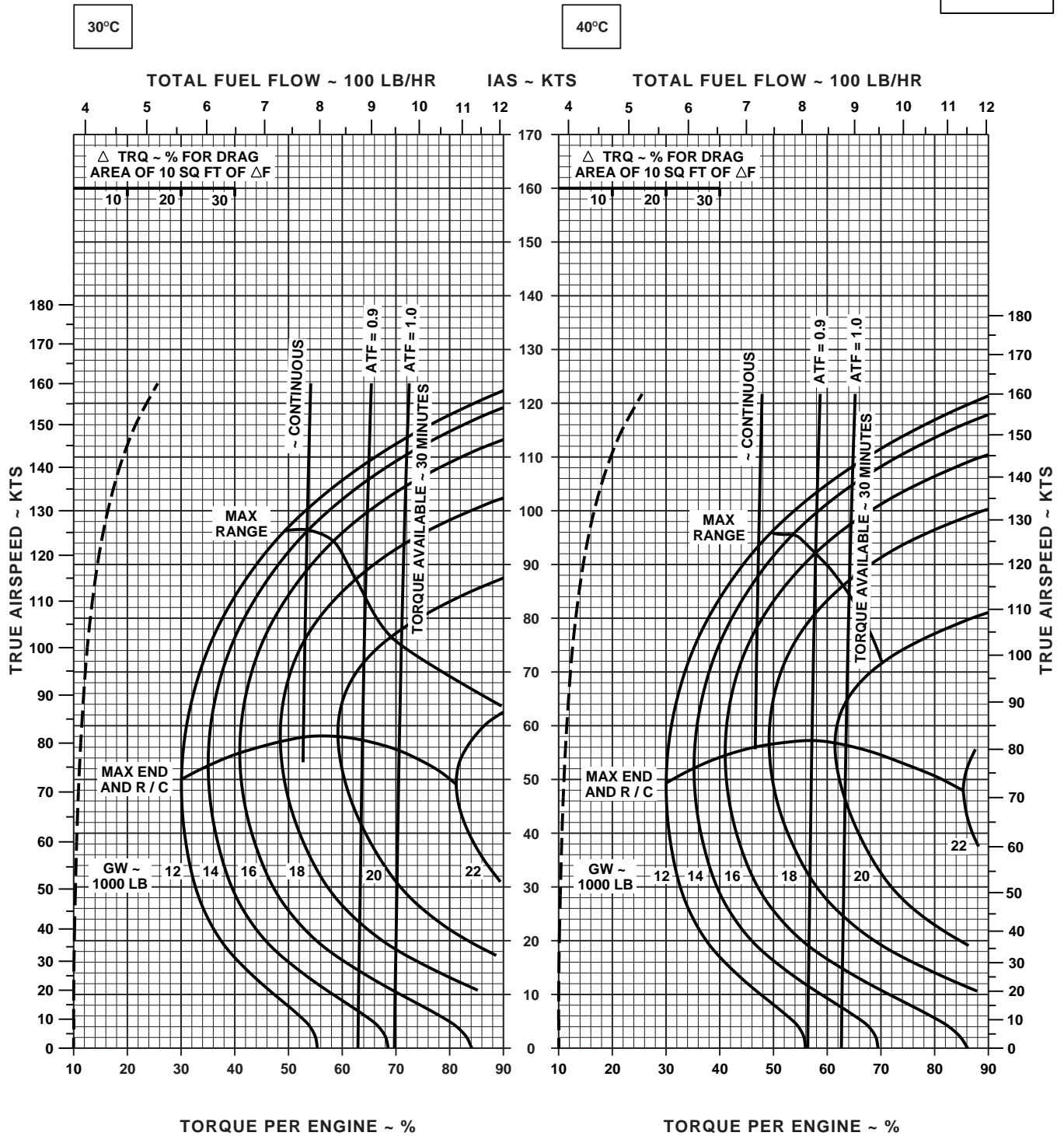

DATA BASE: FLIGHT TEST

AA0568
SA

Figure 7-18. Cruise High Drag - Pressure Altitude 10,000 Feet (Sheet 5 of 5)

CRUISE

CLEAN CONFIGURATION

PRESS ALT: 12000 FT

CRUISE
12000 FT
T700 (2)

-50°C

-40°C

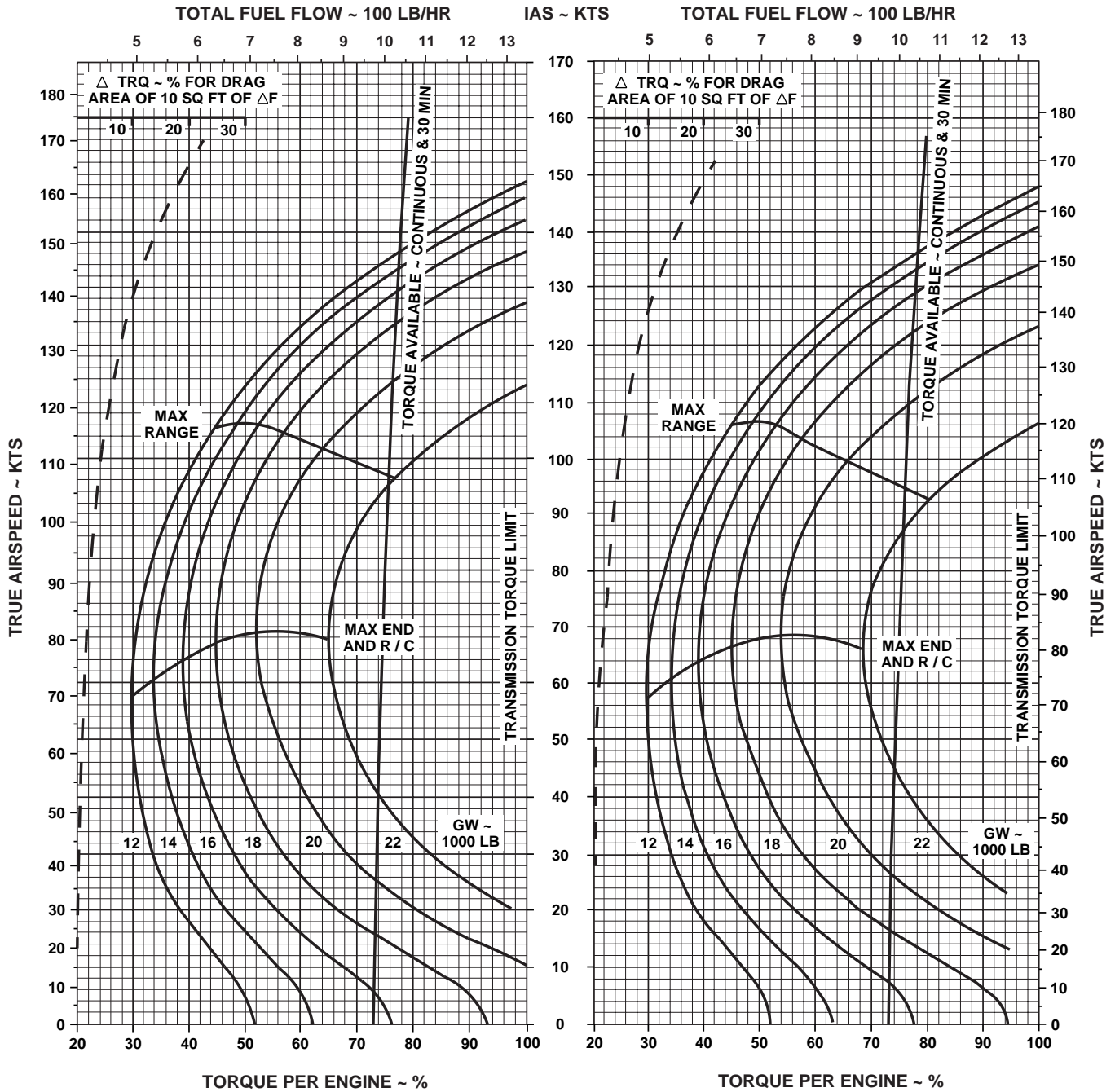

AA0425
SA

Figure 7-19. Cruise - Pressure Altitude 12,000 Feet (Sheet 1 of 5)

CRUISE

CLEAN CONFIGURATION PRESS ALT: 12000 FT

CRUISE
12000 FT
T700 (2)

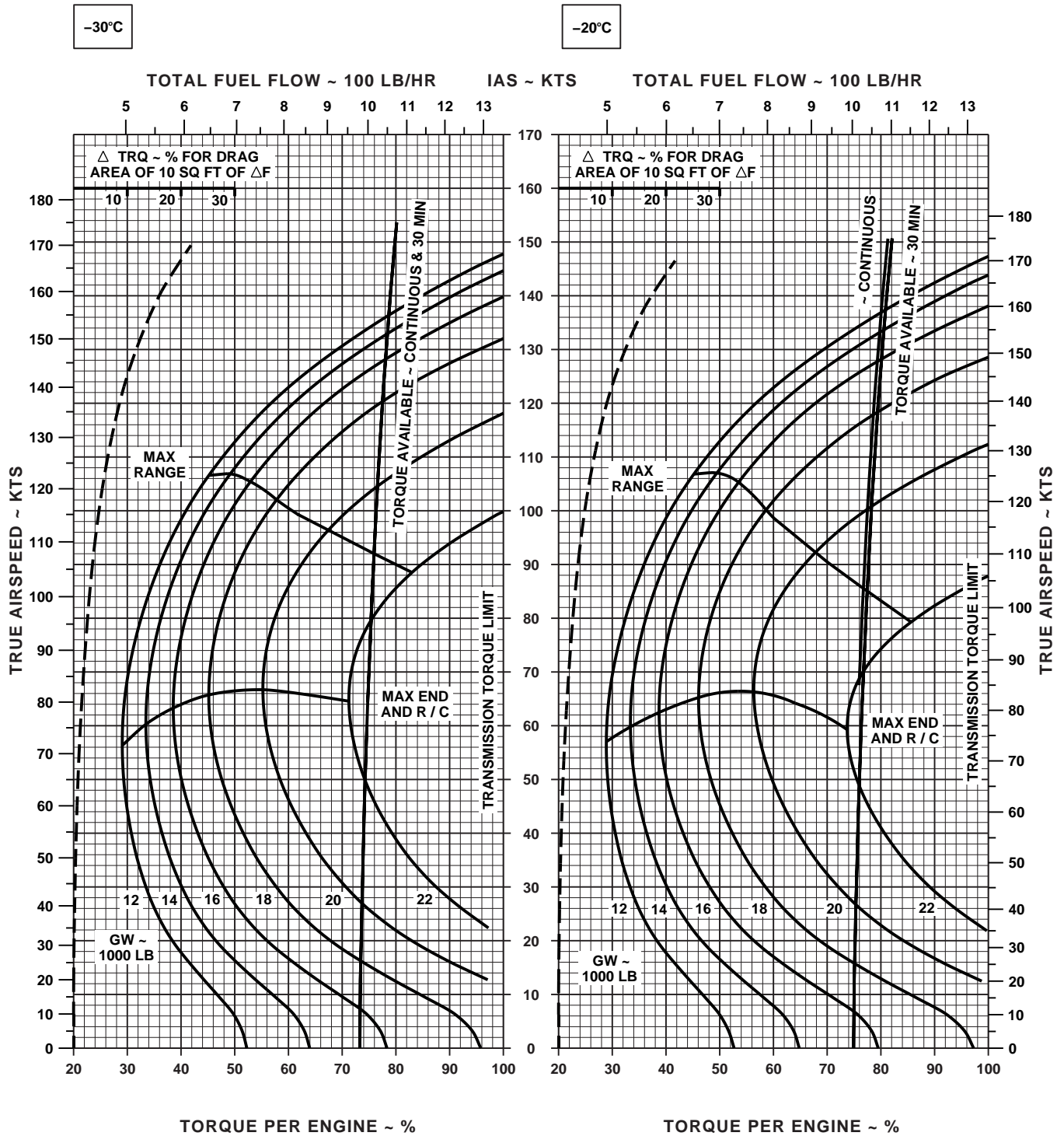

DATA BASE: FLIGHT TEST

AA0424
SA

Figure 7-19. Cruise - Pressure Altitude 12,000 Feet (Sheet 2 of 5)

CRUISE

CLEAN CONFIGURATION

PRESS ALT: 12000 FT

CRUISE
12000 FT
T700 (2)

-10°C

0°C

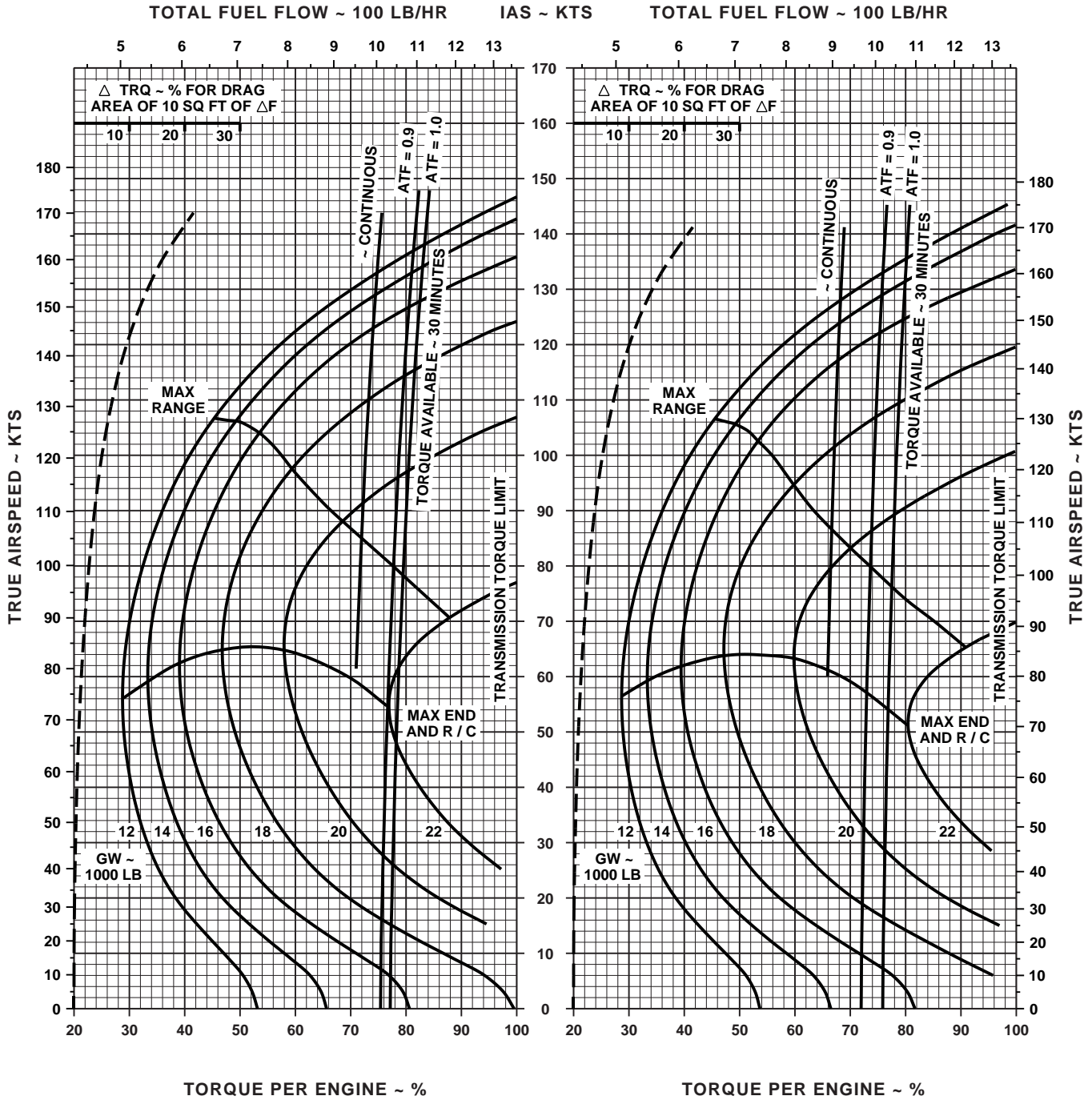

DATA BASE: FLIGHT TEST

AA0423
SA

Figure 7-19. Cruise - Pressure Altitude 12,000 Feet (Sheet 3 of 5)

CRUISE

CLEAN CONFIGURATION PRESS ALT: 12000 FT

CRUISE
12000 FT
T700 (2)

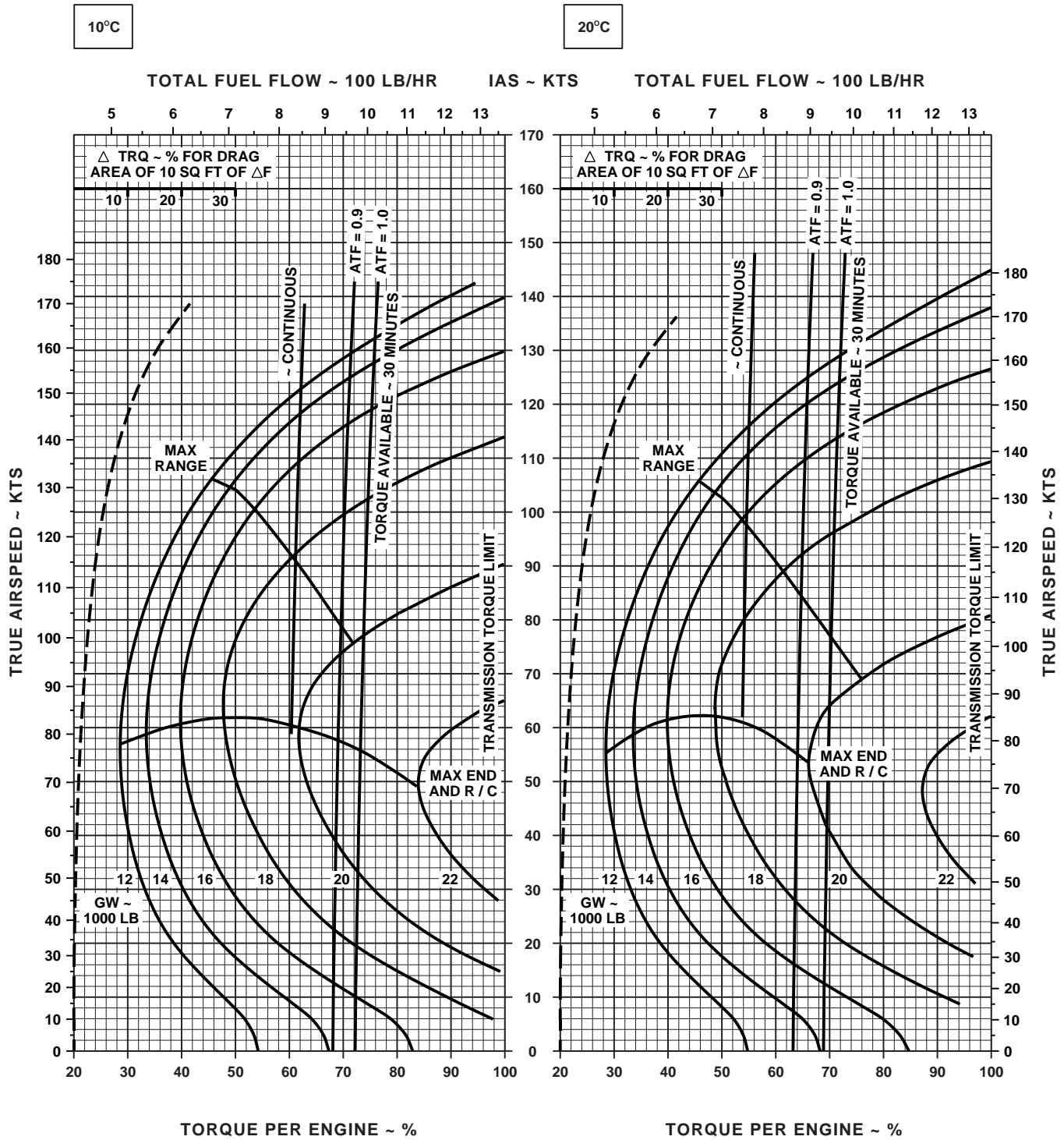

DATA BASE: FLIGHT TEST

AA0426
SA

Figure 7-19. Cruise - Pressure Altitude 12,000 Feet (Sheet 4 of 5)

CRUISE

CLEAN CONFIGURATION

PRESS ALT: 12000 FT

CRUISE
12000 FT
T700 (2)

30°C

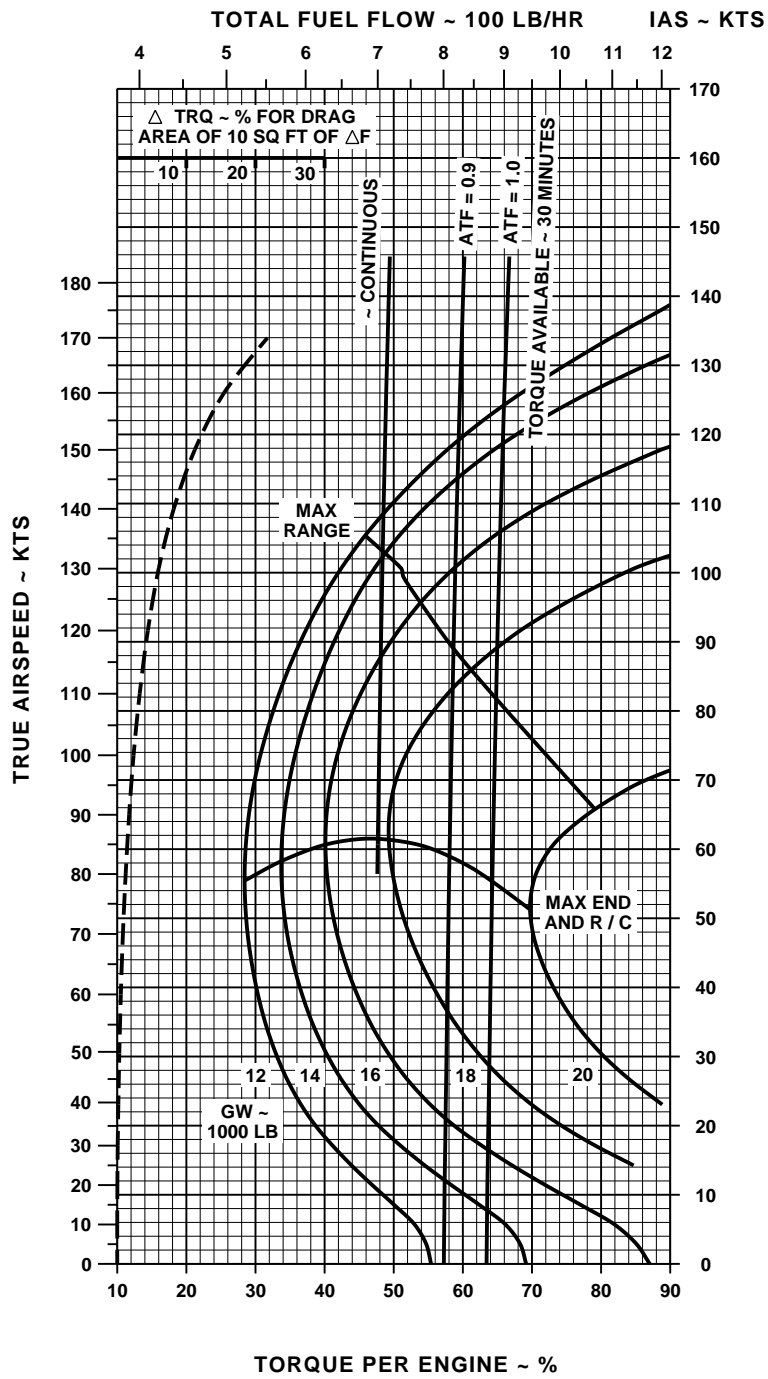

DATA BASIS: FLIGHT TEST

AA0427A
SA

Figure 7-19. Cruise - Pressure Altitude 12,000 Feet (Sheet 5 of 5)

CRUISE

PRESS ALT: 12000 FT

CRUISE
12000 FT
T700 (2)



-50°C

-40°C

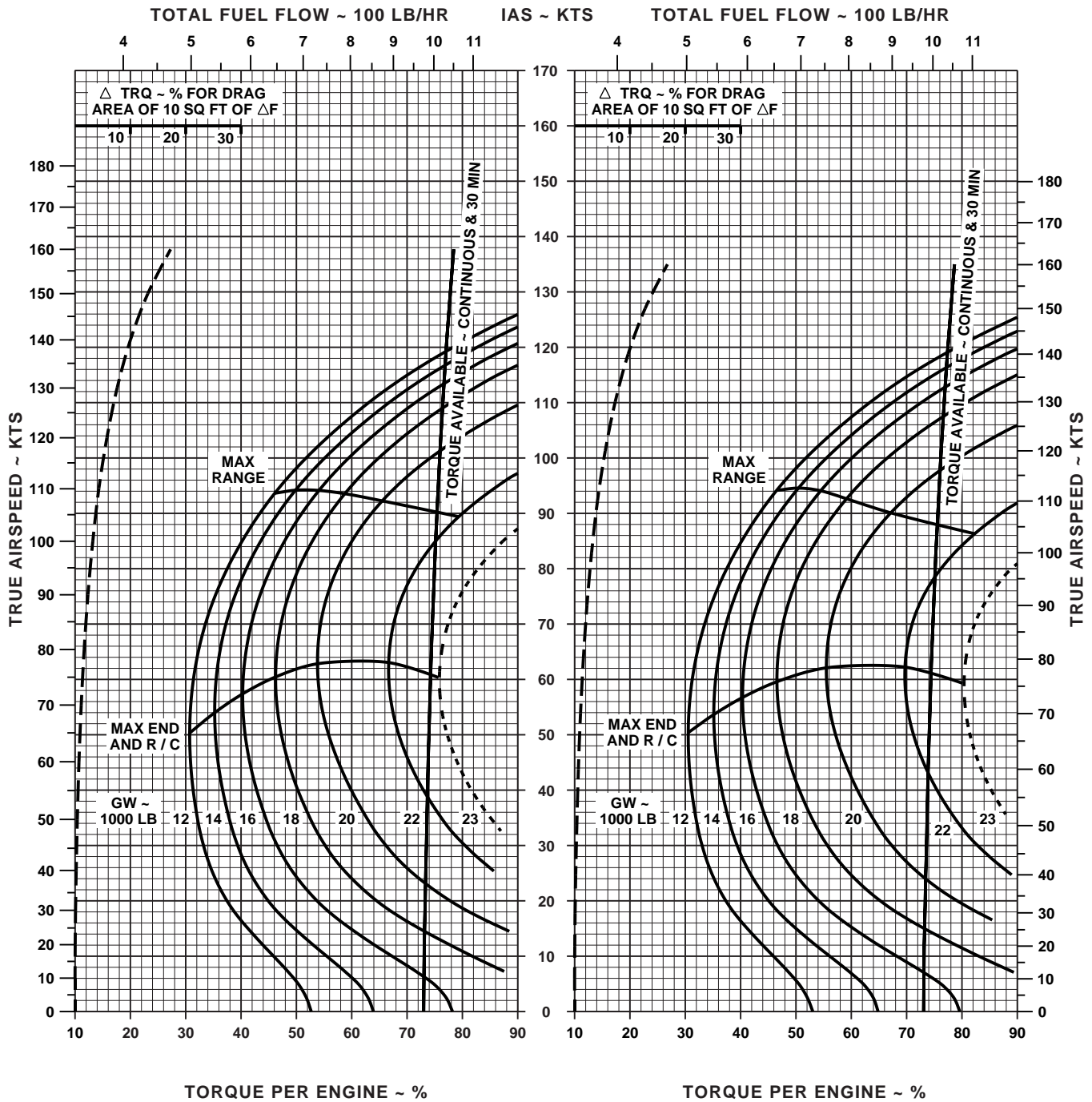

DATA BASE: FLIGHT TEST

AA0569
SA

Figure 7-20. Cruise High Drag - Pressure Altitude 12,000 Feet (Sheet 1 of 5)

CRUISE

PRESS ALT: 12000 FT

CRUISE
12000 FT
T700 (2)



-30°C

-20°C

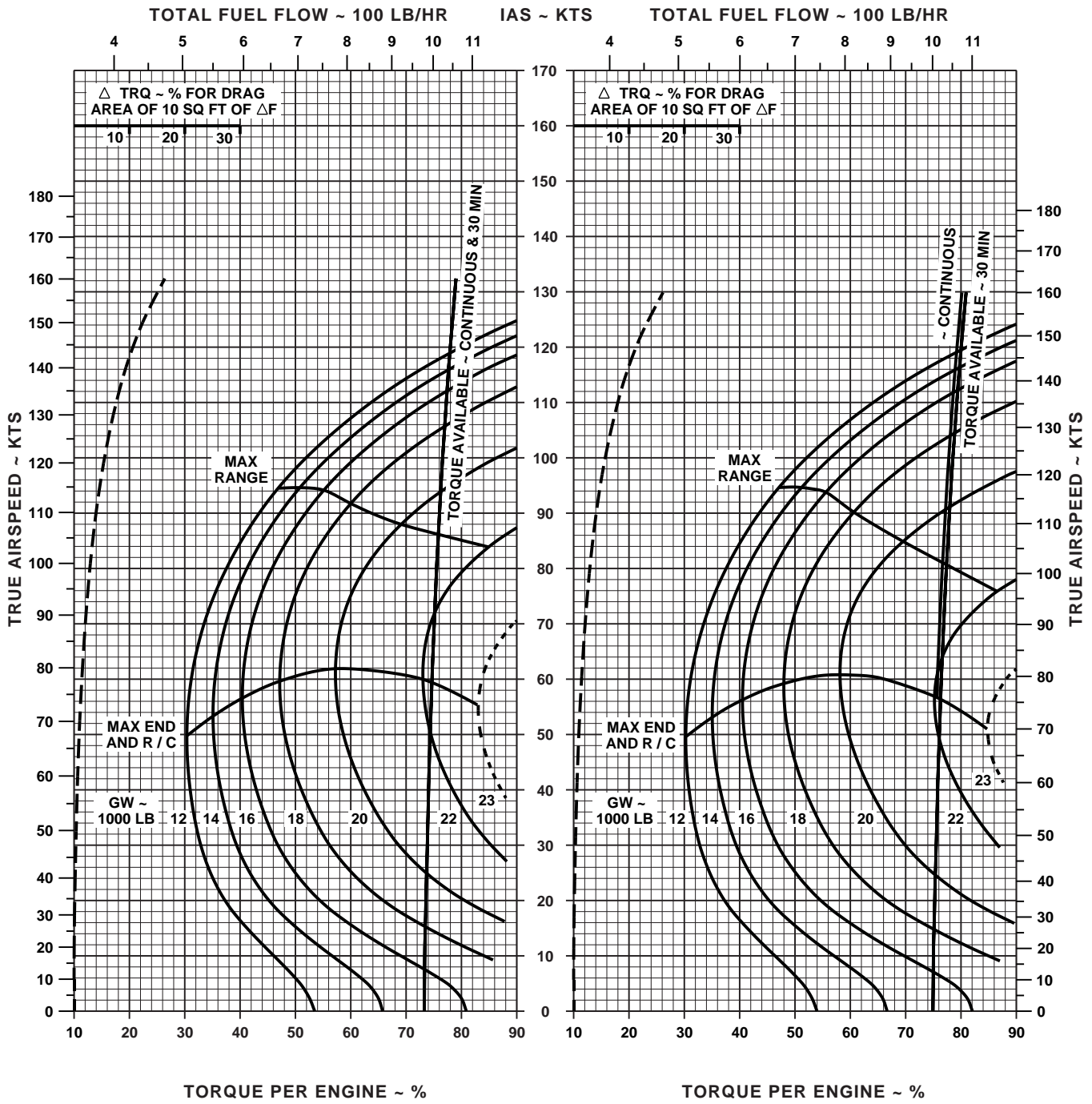

DATA BASE: FLIGHT TEST

AA0570
SA

Figure 7-20. Cruise High Drag - Pressure Altitude 12,000 Feet (Sheet 2 of 5)

CRUISE

PRESS ALT: 12000 FT

CRUISE
12000 FT
T700 (2)



-10°C

0°C

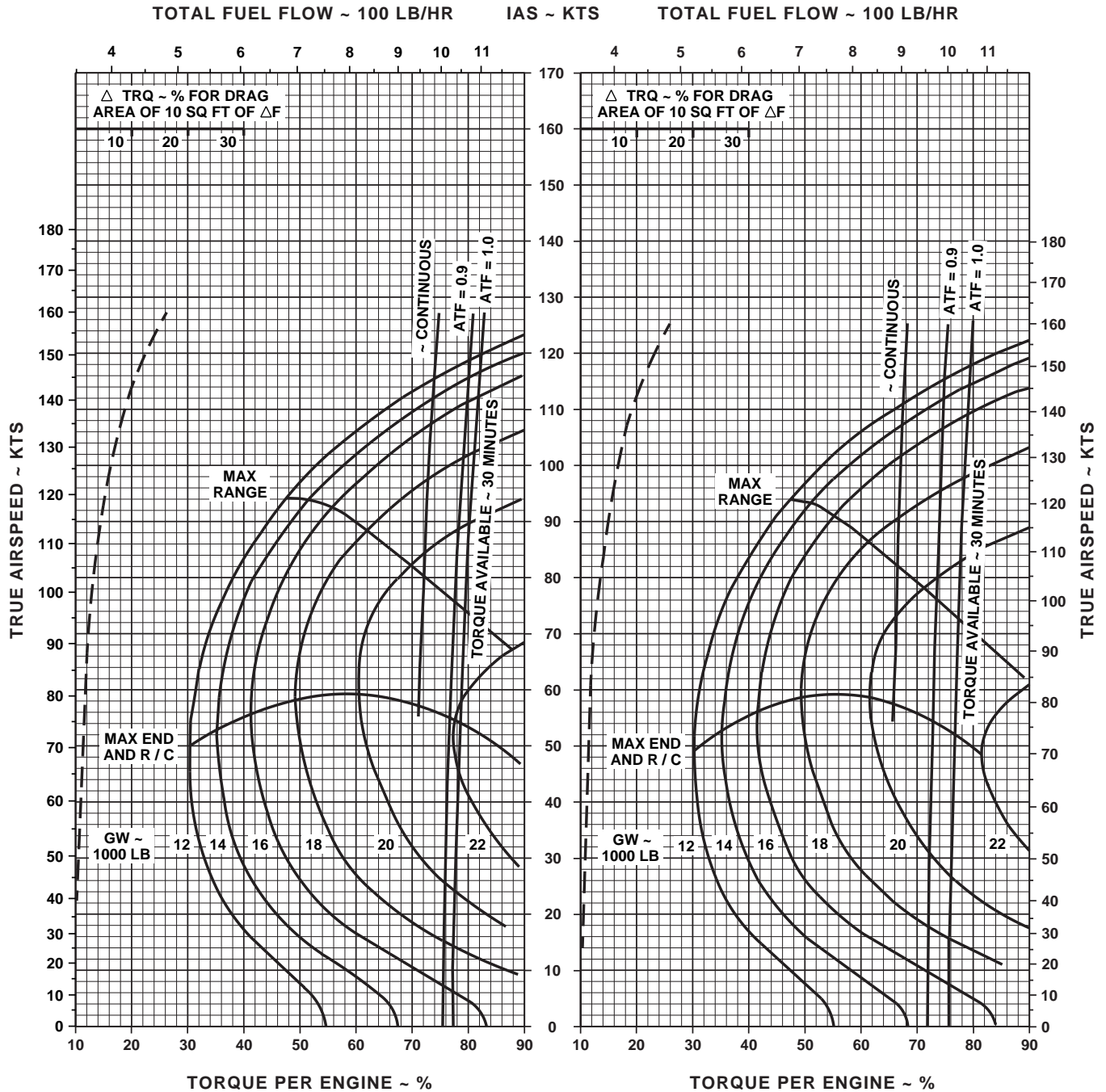

DATA BASE: FLIGHT TEST

AA0571
SA

Figure 7-20. Cruise High Drag - Pressure Altitude 12,000 Feet (Sheet 3 of 5)

CRUISE

PRESS ALT: 12000 FT

CRUISE
12000 FT
T700 (2)



10°C

20°C

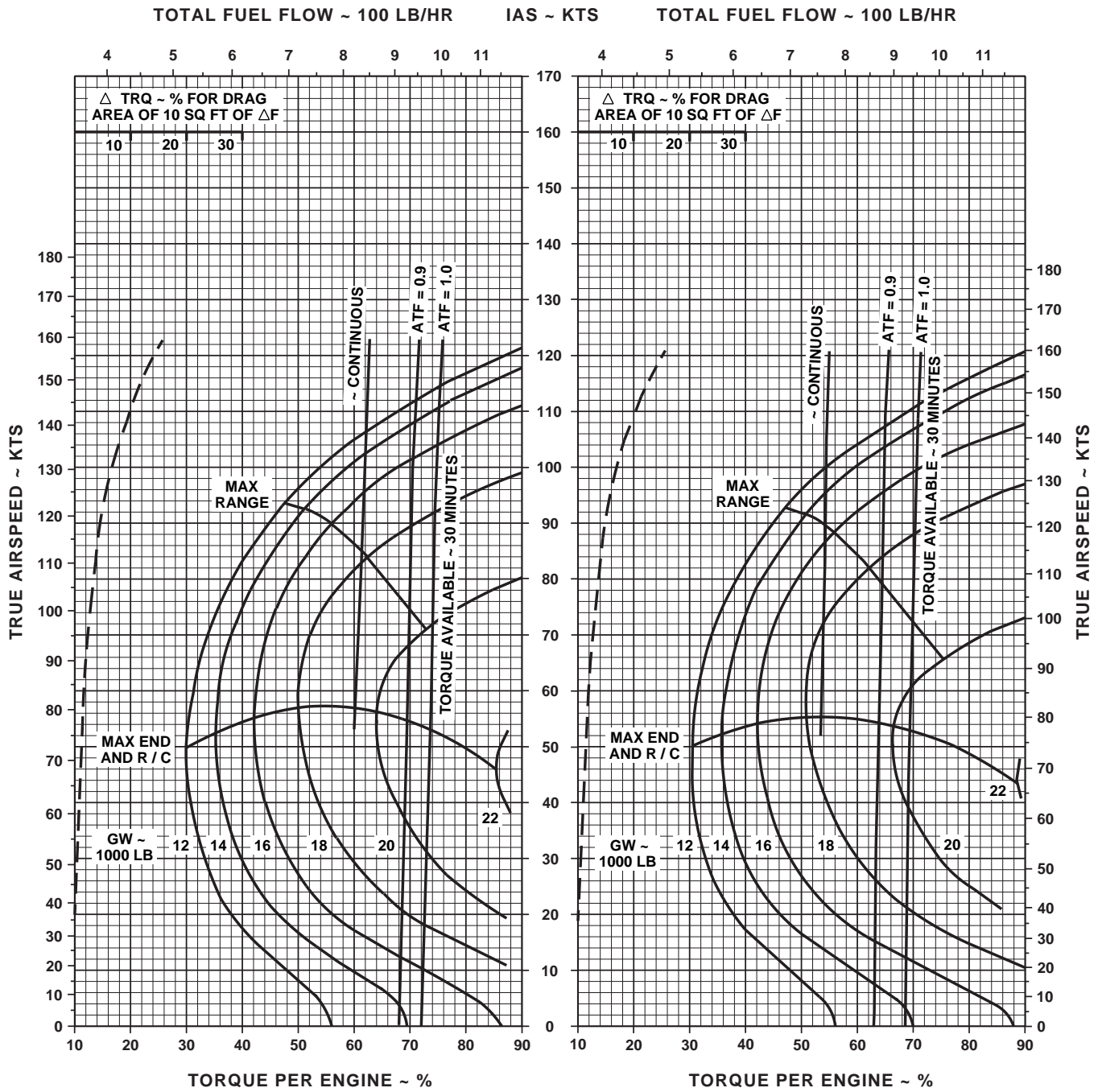

DATA BASE: FLIGHT TEST

AA0572
SA

Figure 7-20. Cruise High Drag - Pressure Altitude 12,000 Feet (Sheet 4 of 5)

CRUISE

PRESS ALT: 12000 FT

30°C

CRUISE
12000 FT
T700 (2)



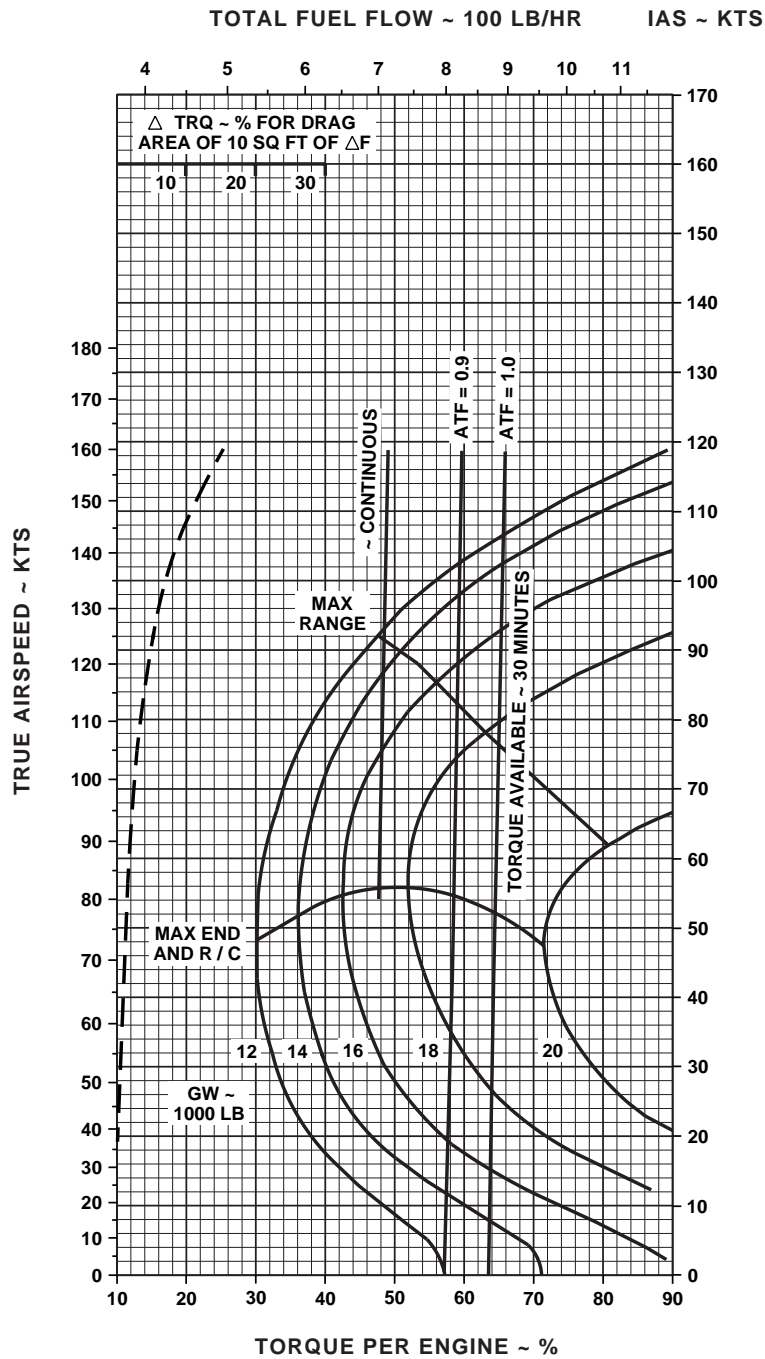

DATA BASE: FLIGHT TEST

AA0573
SA

Figure 7-20. Cruise High Drag - Pressure Altitude 12,000 Feet (Sheet 5 of 5)

CRUISE

CLEAN CONFIGURATION PRESS ALT: 14000 FT

CRUISE
14000 FT
T700 (2)

-50°C

-40°C

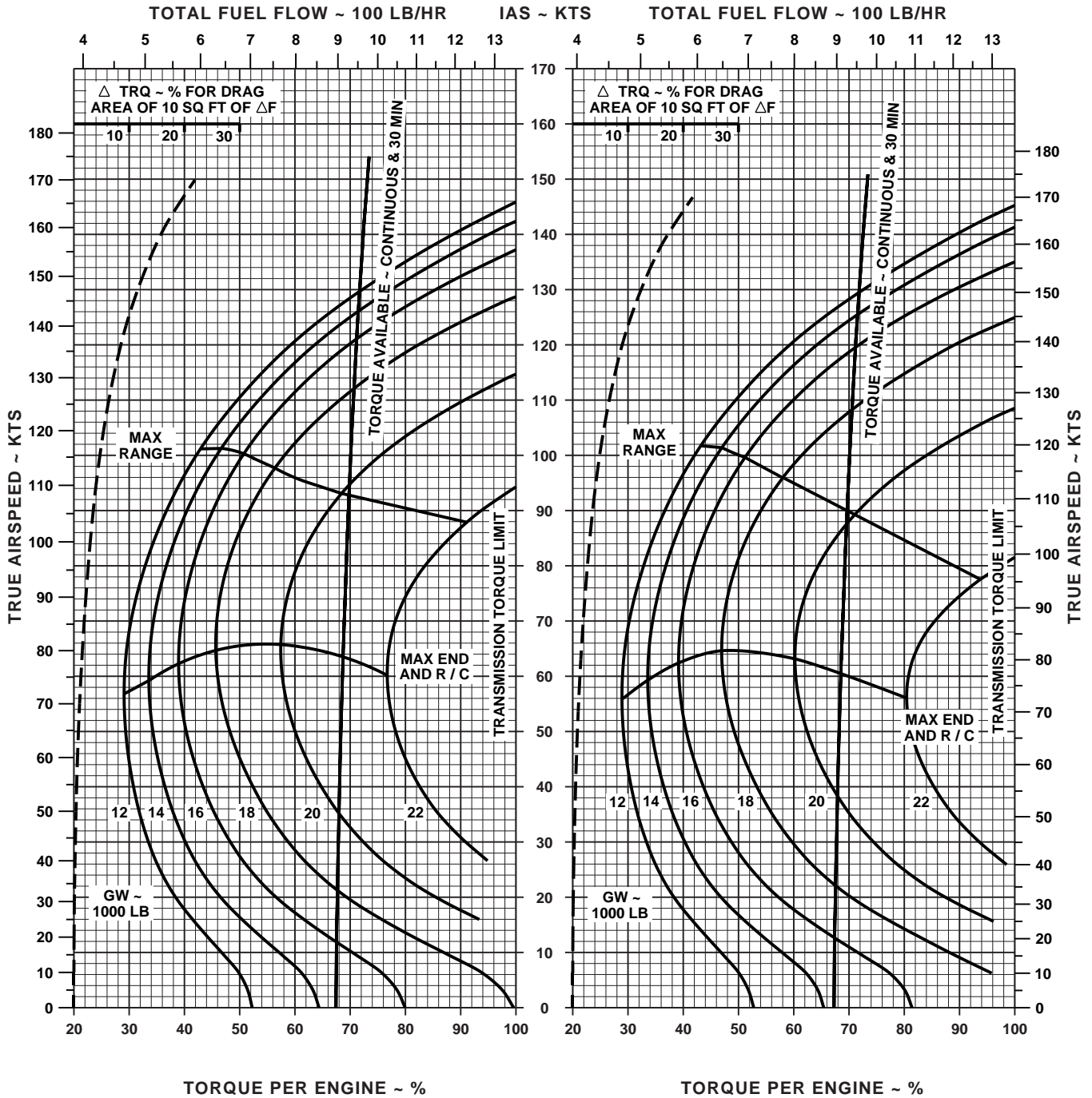

DATA BASE: FLIGHT TEST

AA0430
SA

Figure 7-21. Cruise - Pressure Altitude 14,000 Feet (Sheet 1 of 5)

CRUISE

CLEAN CONFIGURATION

PRESS ALT: 14000 FT

CRUISE
14000 FT
T700 (2)

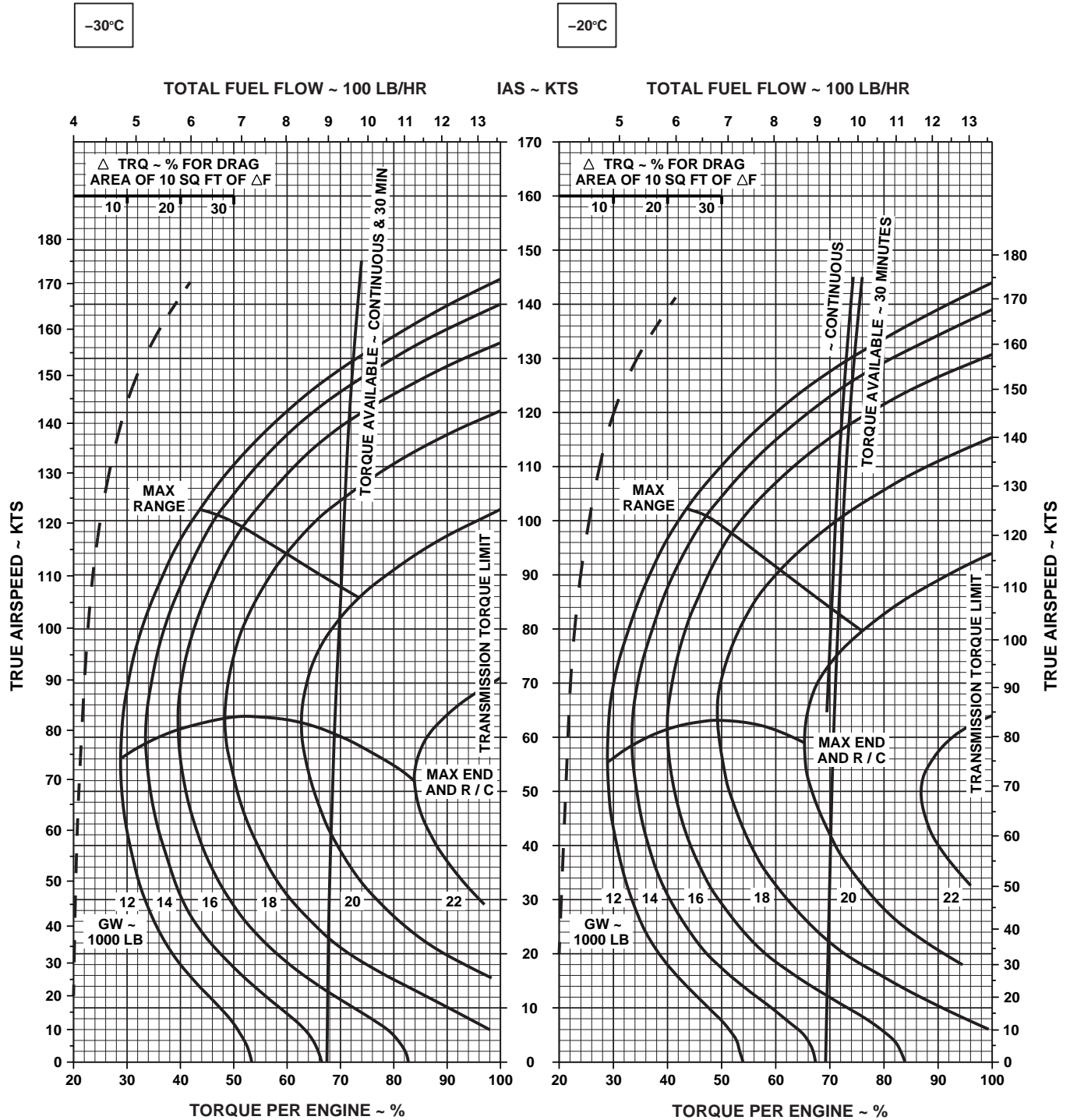

Figure 7-21. Cruise - Pressure Altitude 14,000 Feet (Sheet 2 of 5)

AA0429
SA

CRUISE

CLEAN CONFIGURATION

PRESS ALT: 14000 FT

CRUISE
14000 FT
T700 (2)

-10°C

0°C

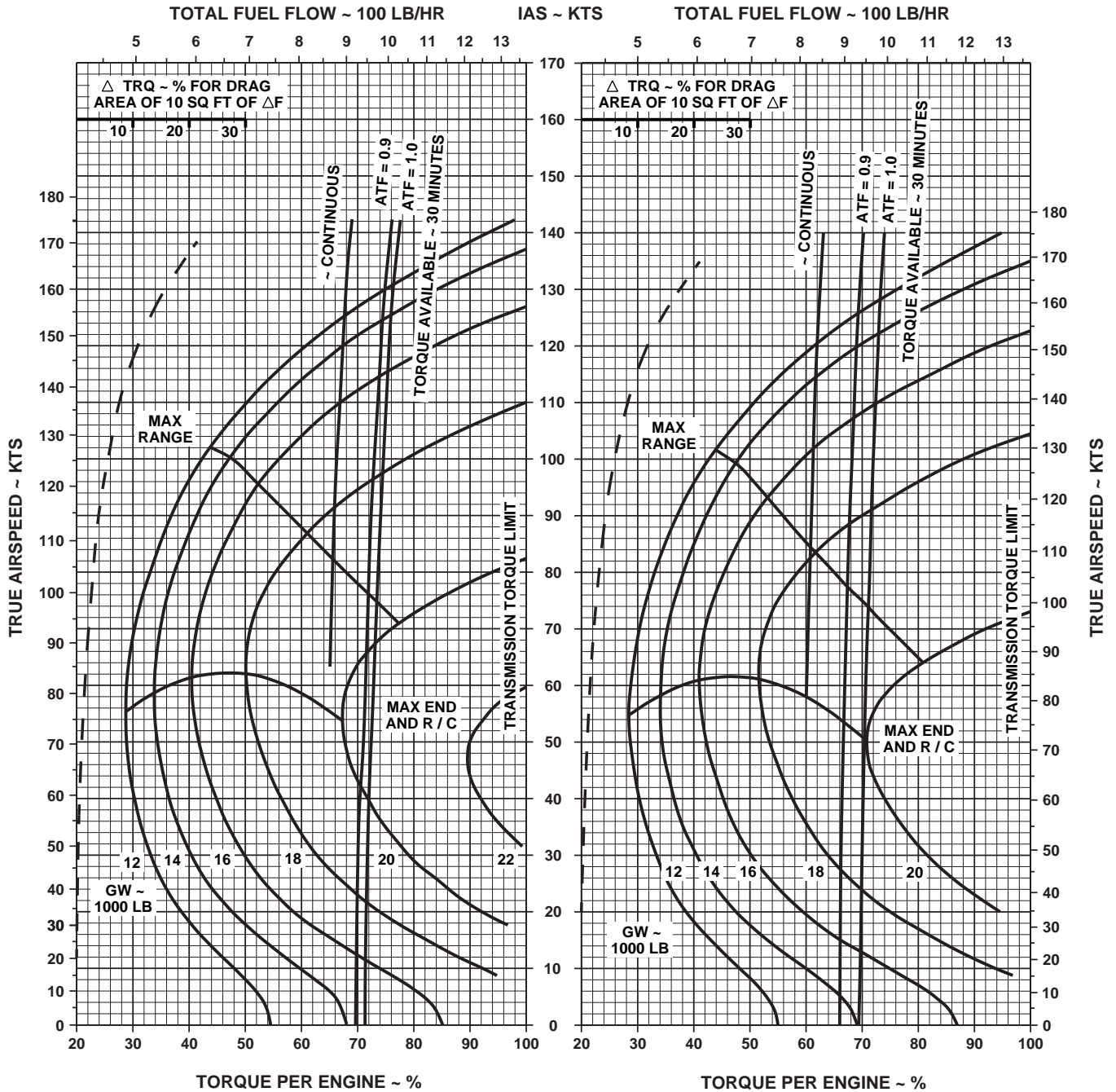

AA0428
SA

Figure 7-21. Cruise - Pressure Altitude 14,000 Feet (Sheet 3 of 5)

CRUISE

CLEAN CONFIGURATION PRESS ALT: 14000 FT

CRUISE
14000 FT
T700 (2)

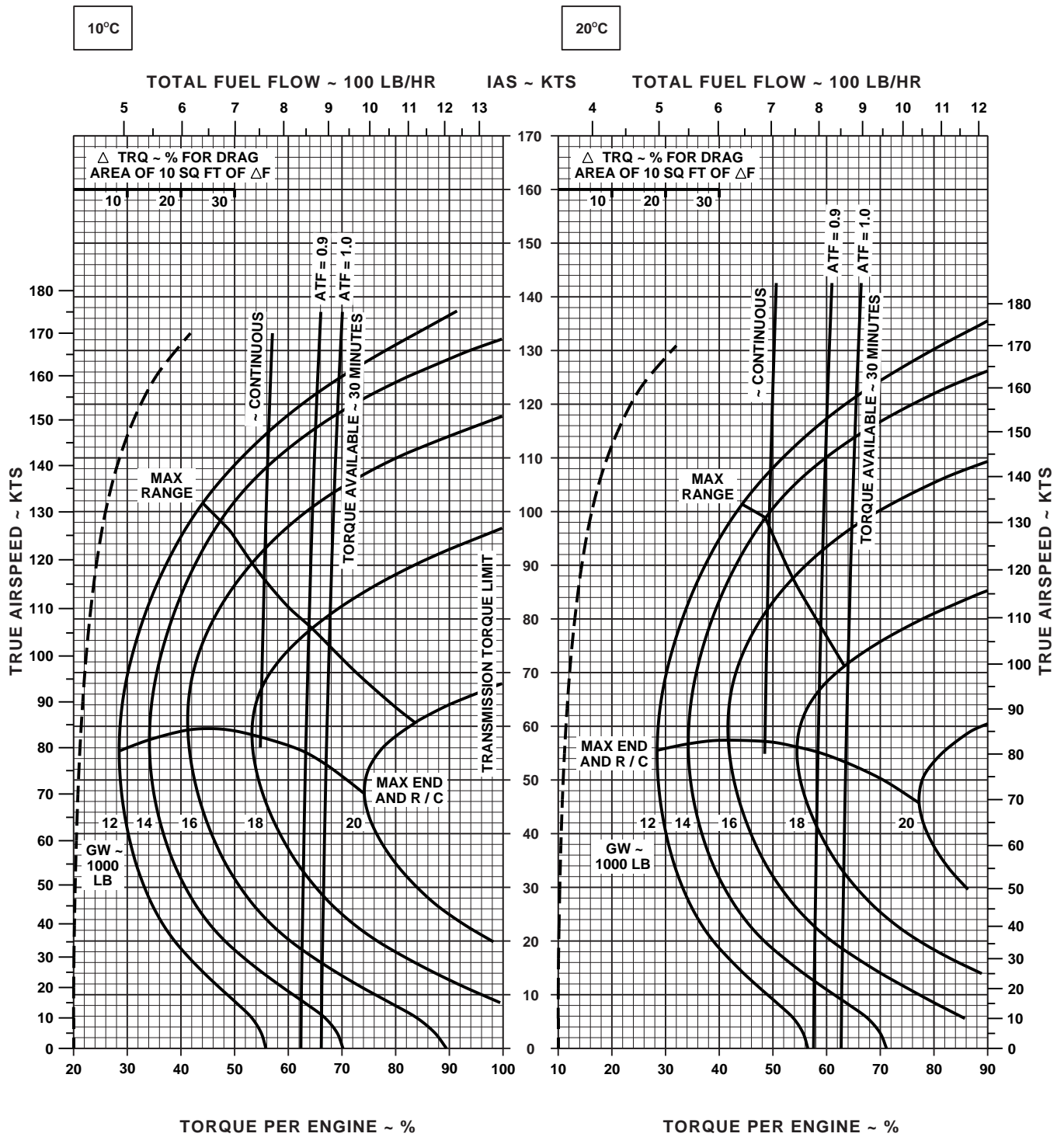

DATA BASE: FLIGHT TEST

AA0431
SA

Figure 7-21. Cruise - Pressure Altitude 14,000 Feet (Sheet 4 of 5)

CRUISE

CLEAN CONFIGURATION

PRESS ALT: 14000 FT

CRUISE
14000 FT
T700 (2)

30°C

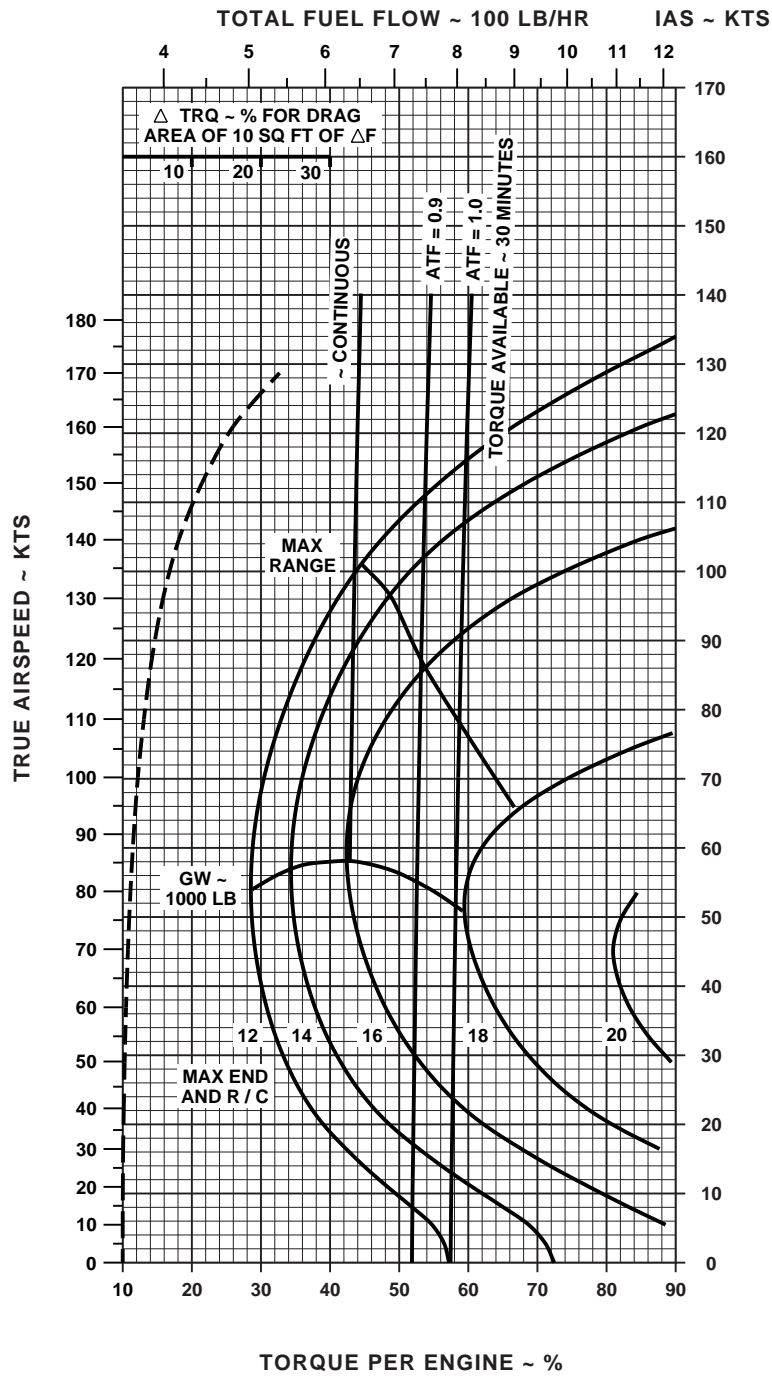

DATA BASE: FLIGHT TEST

AA0432
SA

Figure 7-21. Cruise - Pressure Altitude 14,000 Feet (Sheet 5 of 5)

CRUISE

PRESS ALT: 14000 FT

CRUISE
14000 FT
T700 (2)



-50°C

-40°C

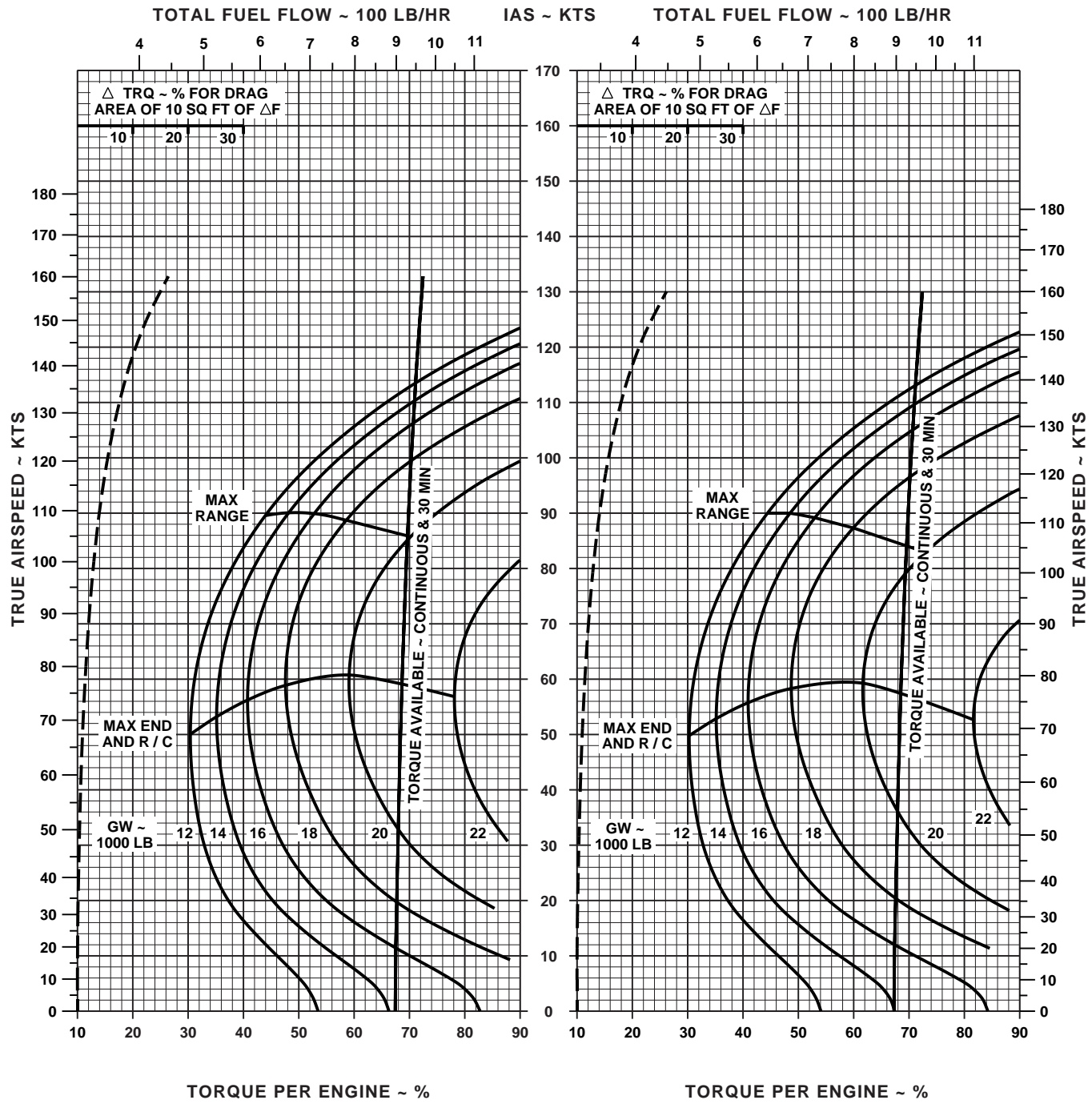

DATA BASE: FLIGHT TEST

AA0574 SA

Figure 7-22. Cruise High Drag - Pressure Altitude 14,000 Feet (Sheet 1 of 5)

CRUISE

PRESS ALT: 14000 FT

CRUISE
14000 FT
T700 (2)



-30°C

-20°C

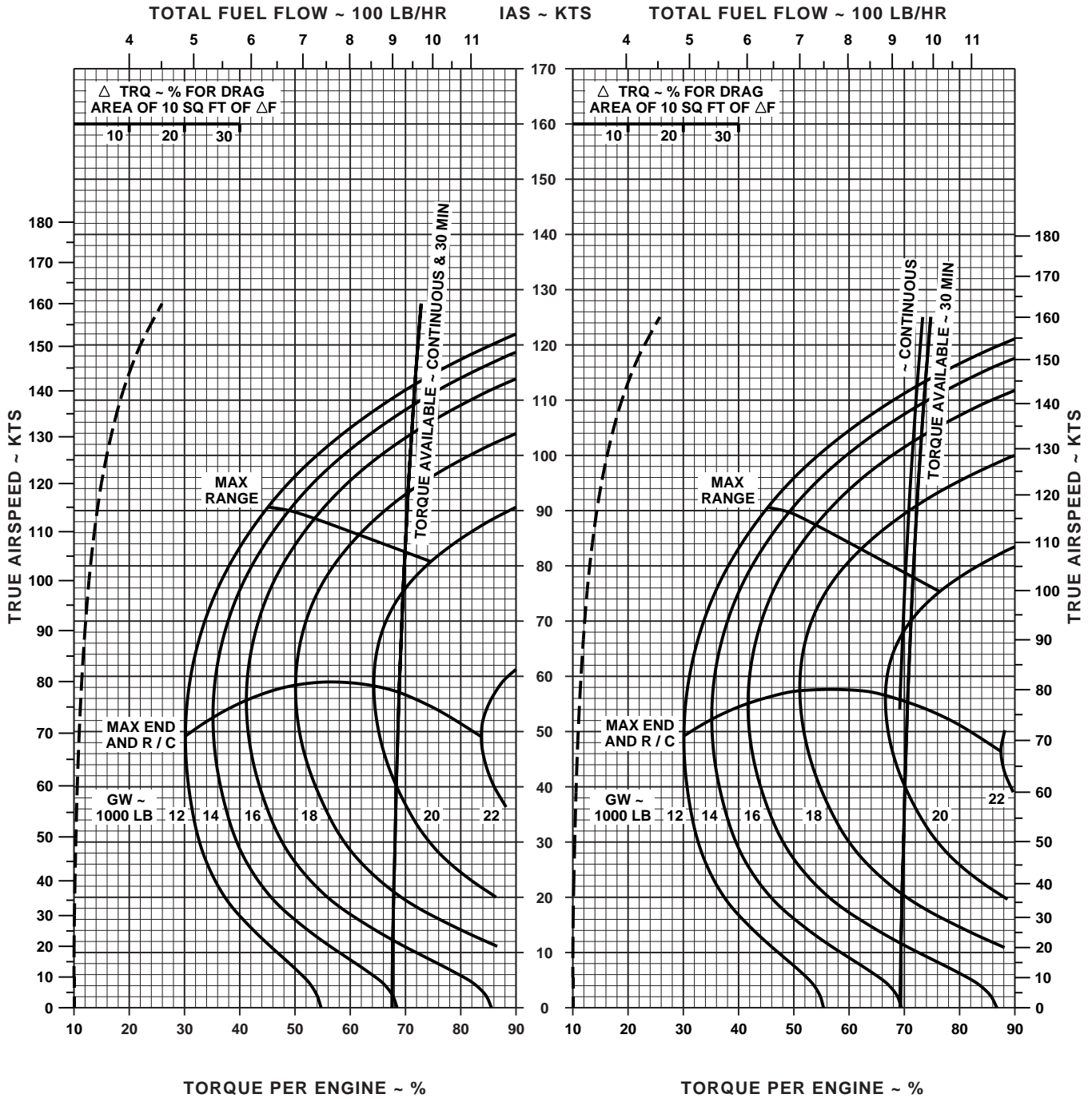

DATA BASE: FLIGHT TEST

AA0575
SA

Figure 7-22. Cruise High Drag - Pressure Altitude 14,000 Feet (Sheet 2 of 5)

CRUISE

PRESS ALT: 14000 FT

CRUISE
14000 FT
T700 (2)



-10°C

0°C

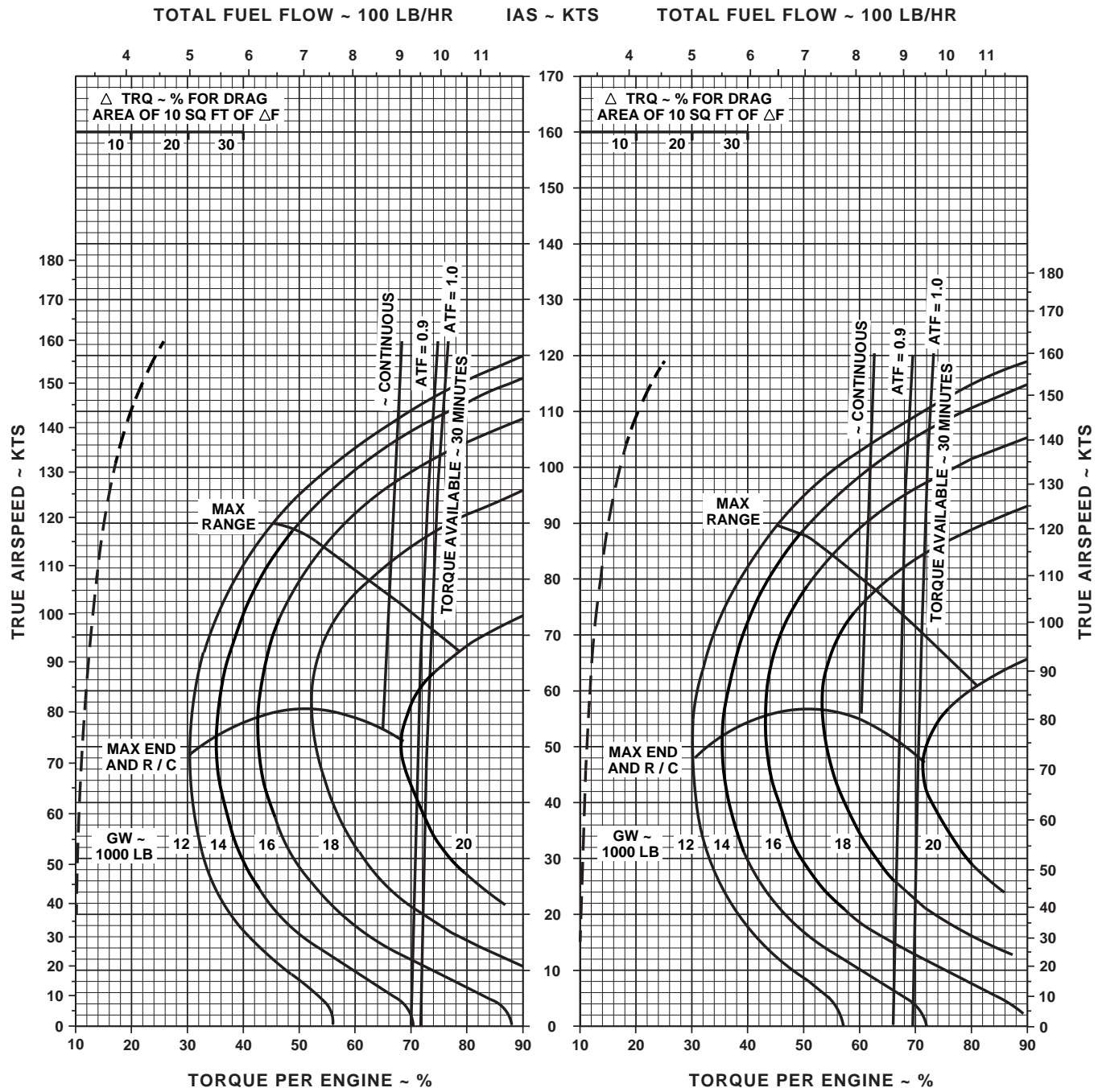

DATA BASE: FLIGHT TEST

AA0576
SA

Figure 7-22. Cruise High Drag - Pressure Altitude 14,000 Feet (Sheet 3 of 5)

CRUISE

PRESS ALT: 14000 FT

CRUISE
14000 FT
T700 (2)



10°C

20°C

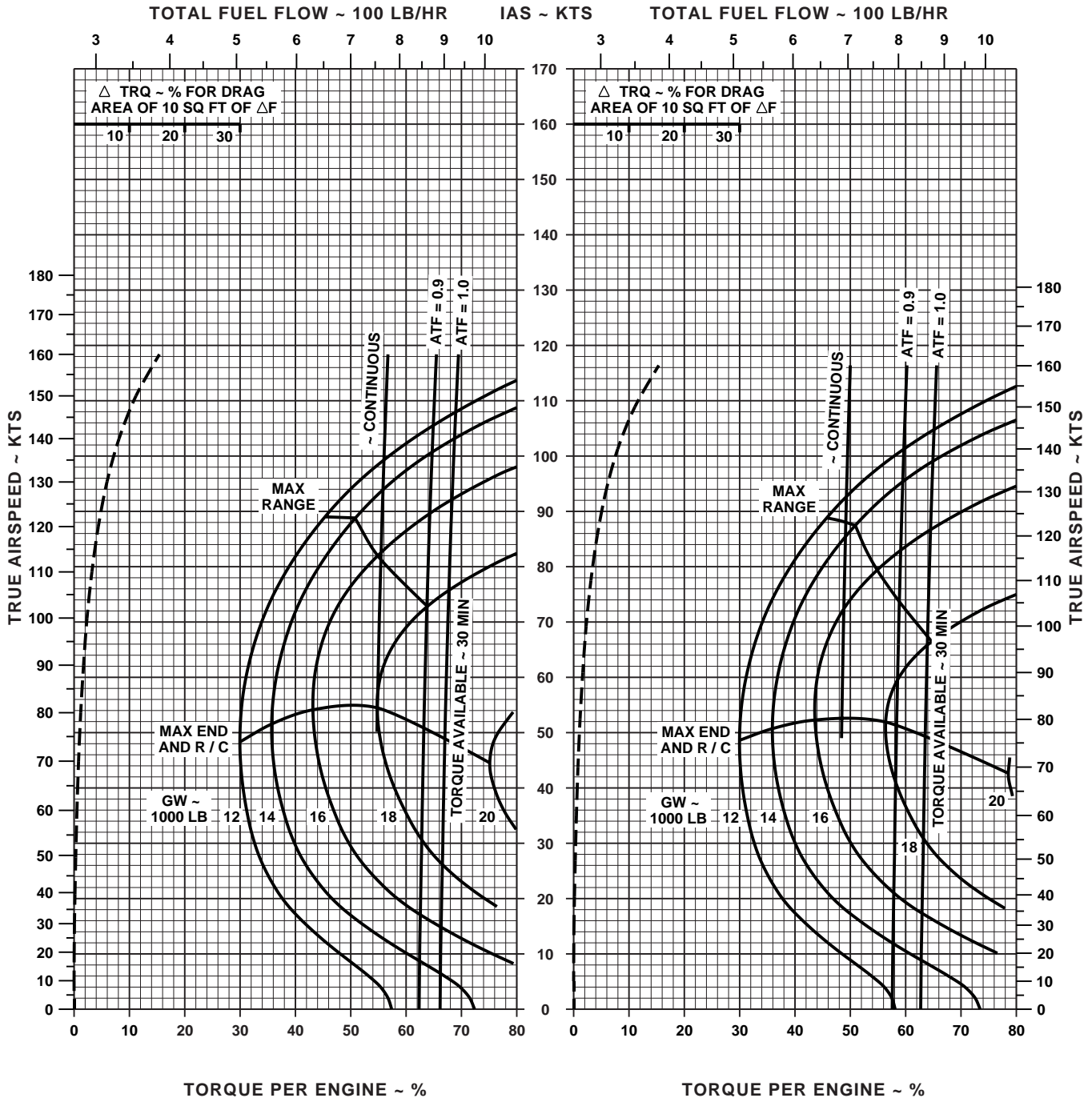

DATA BASE: FLIGHT TEST

AA0577
SA

Figure 7-22. Cruise High Drag - Pressure Altitude 14,000 Feet (Sheet 4 of 5)

CRUISE

PRESS ALT: 14000 FT

30°C

CRUISE
14000 FT
T700 (2)

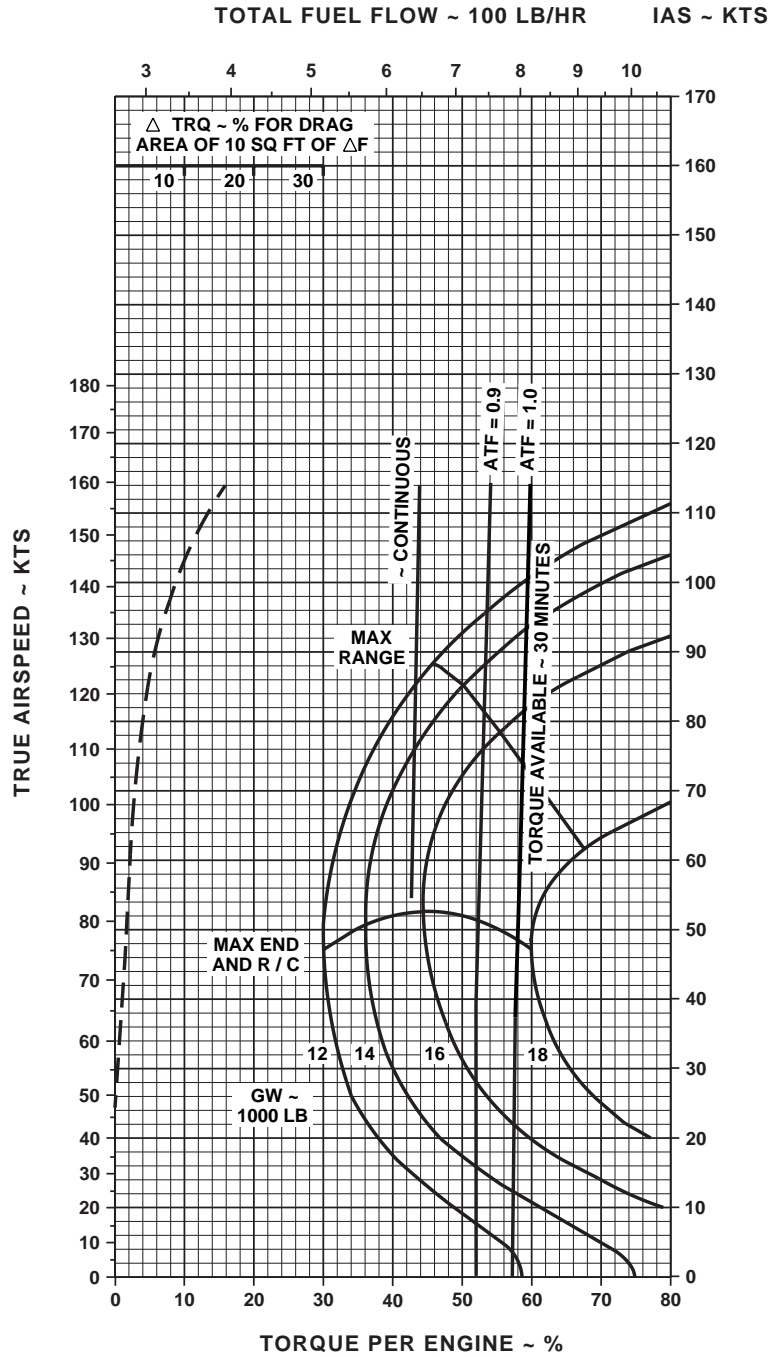
DATA BASE: FLIGHT TEST

AA0578
SA

Figure 7-22. Cruise High Drag - Pressure Altitude 14,000 Feet (Sheet 5 of 5)

CRUISE

CLEAN CONFIGURATION PRESS ALT: 16000 FT

CRUISE
16000 FT
T700 (2)

-50°C

-40°C

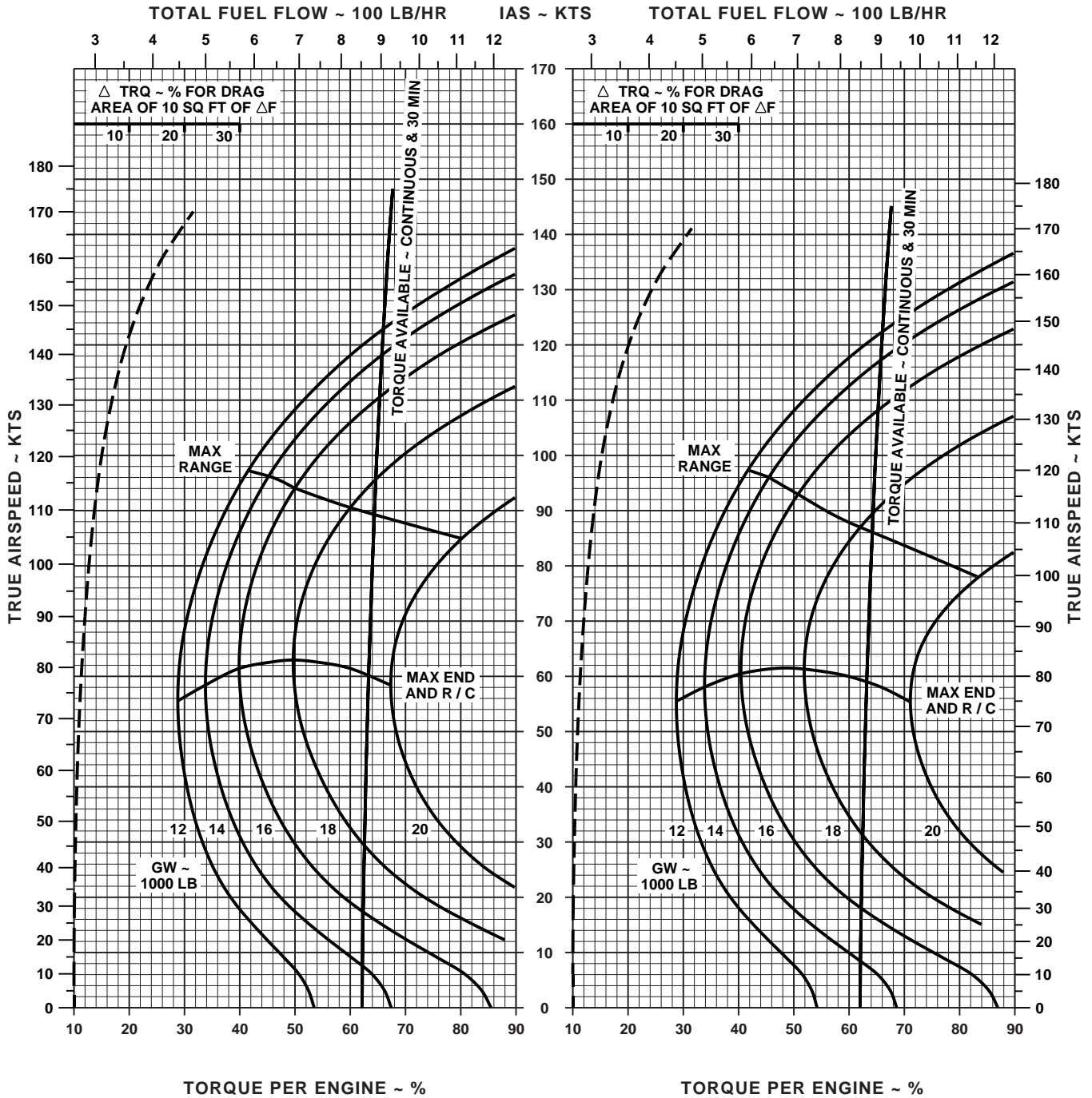

DATA BASE: FLIGHT TEST

AA0435
SA

Figure 7-23. Cruise - Pressure Altitude 16,000 Feet (Sheet 1 of 5)

CRUISE

CLEAN CONFIGURATION PRESS ALT: 16000 FT

CRUISE
16000 FT
T700 (2)

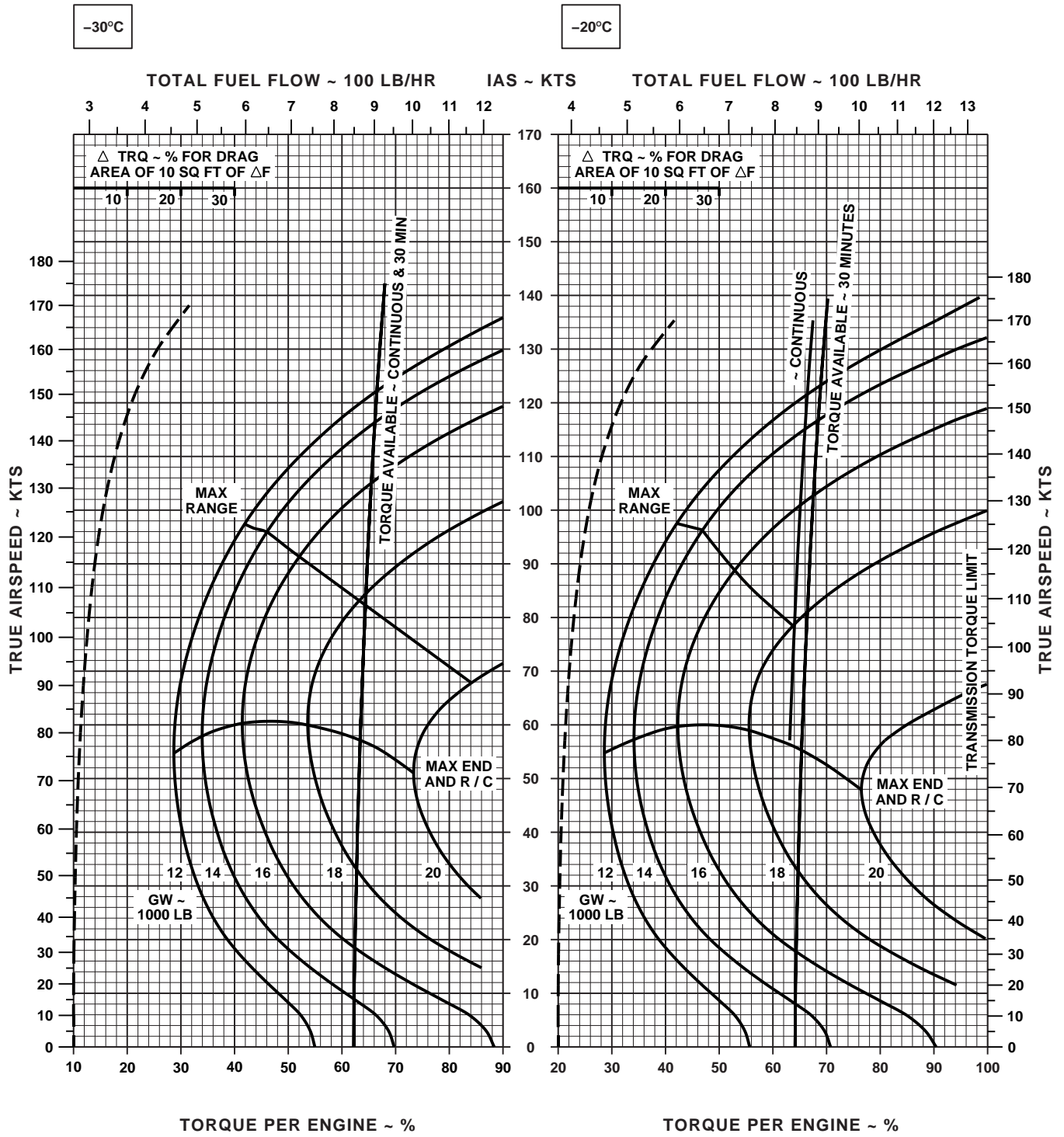

DATA BASIS: FLIGHT TEST

AA0434A
SA

Figure 7-23. Cruise - Pressure Altitude 16,000 Feet (Sheet 2 of 5)

CRUISE

CLEAN CONFIGURATION

PRESS ALT: 16000 FT

CRUISE
16000 FT
T700 (2)

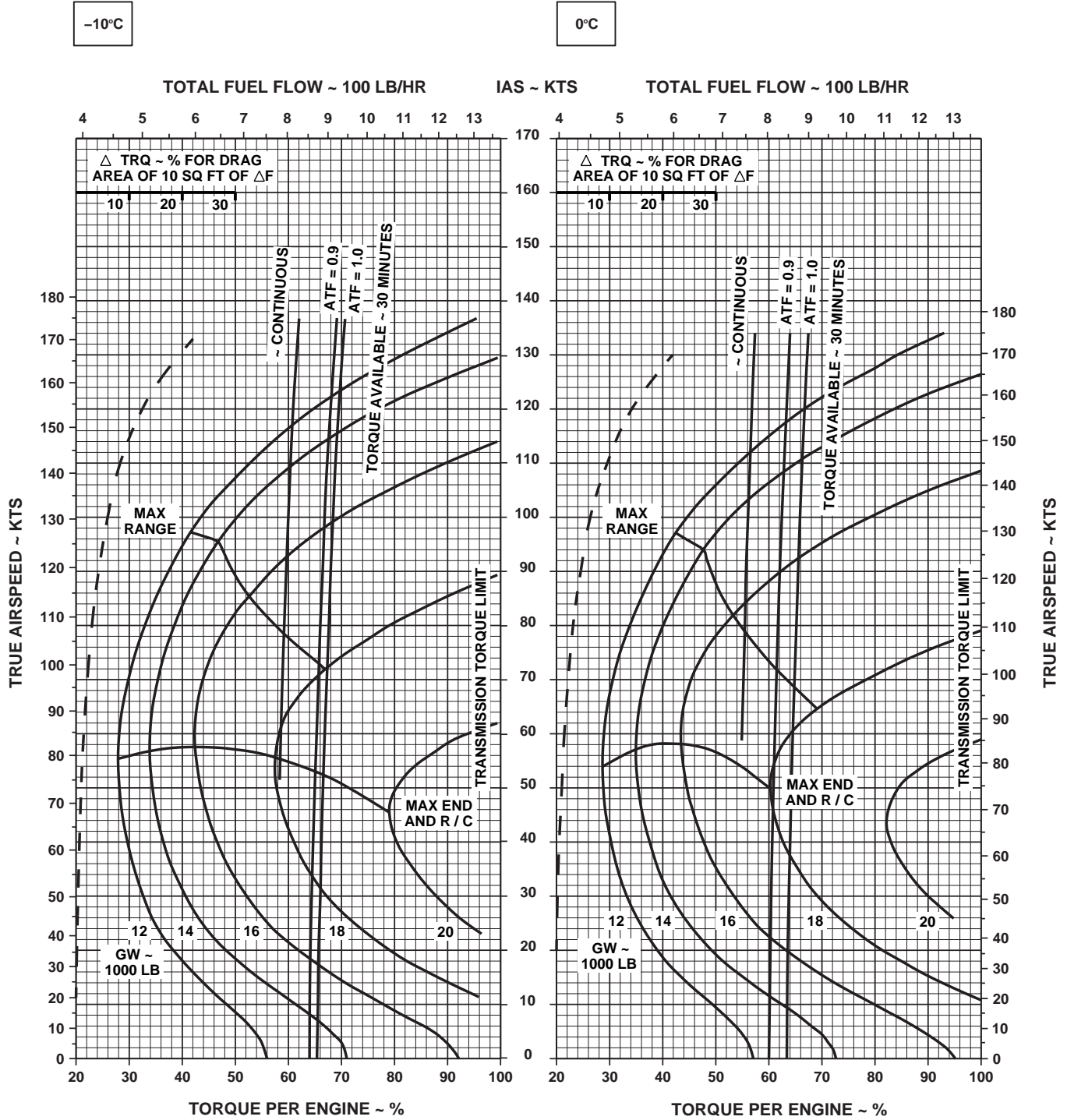

AA0433
SA

Figure 7-23. Cruise - Pressure Altitude 16,000 Feet (Sheet 3 of 5)

CRUISE CLEAN CONFIGURATION PRESS ALT: 16000 FT

CRUISE
16000 FT
T700 (2)

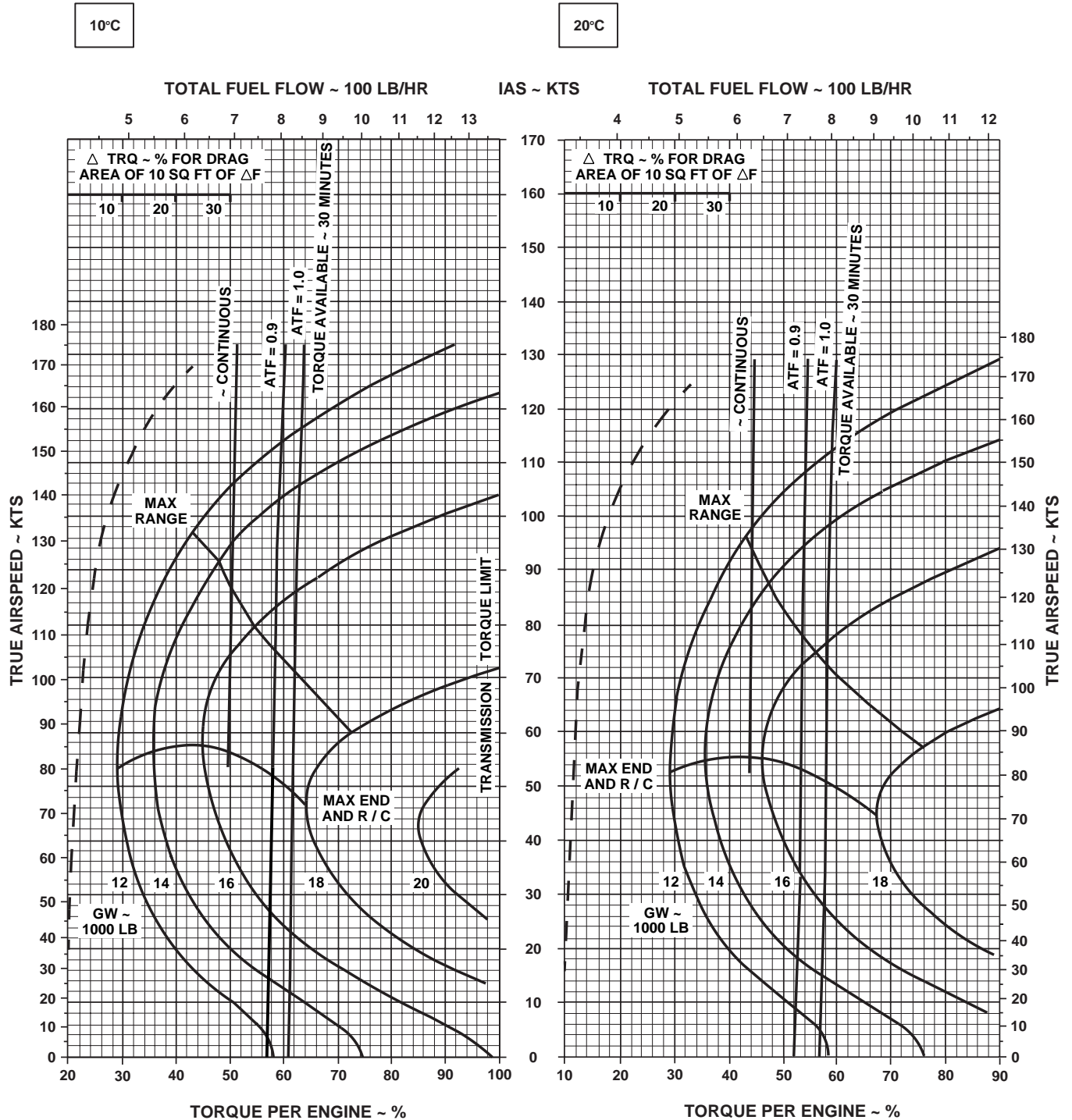

Figure 7-23. Cruise - Pressure Altitude 16,000 Feet (Sheet 4 of 5)

AA0436
SA

CRUISE

CLEAN CONFIGURATION

PRESS ALT: 16000 FT

CRUISE
16000 FT
T700 (2)

30°C

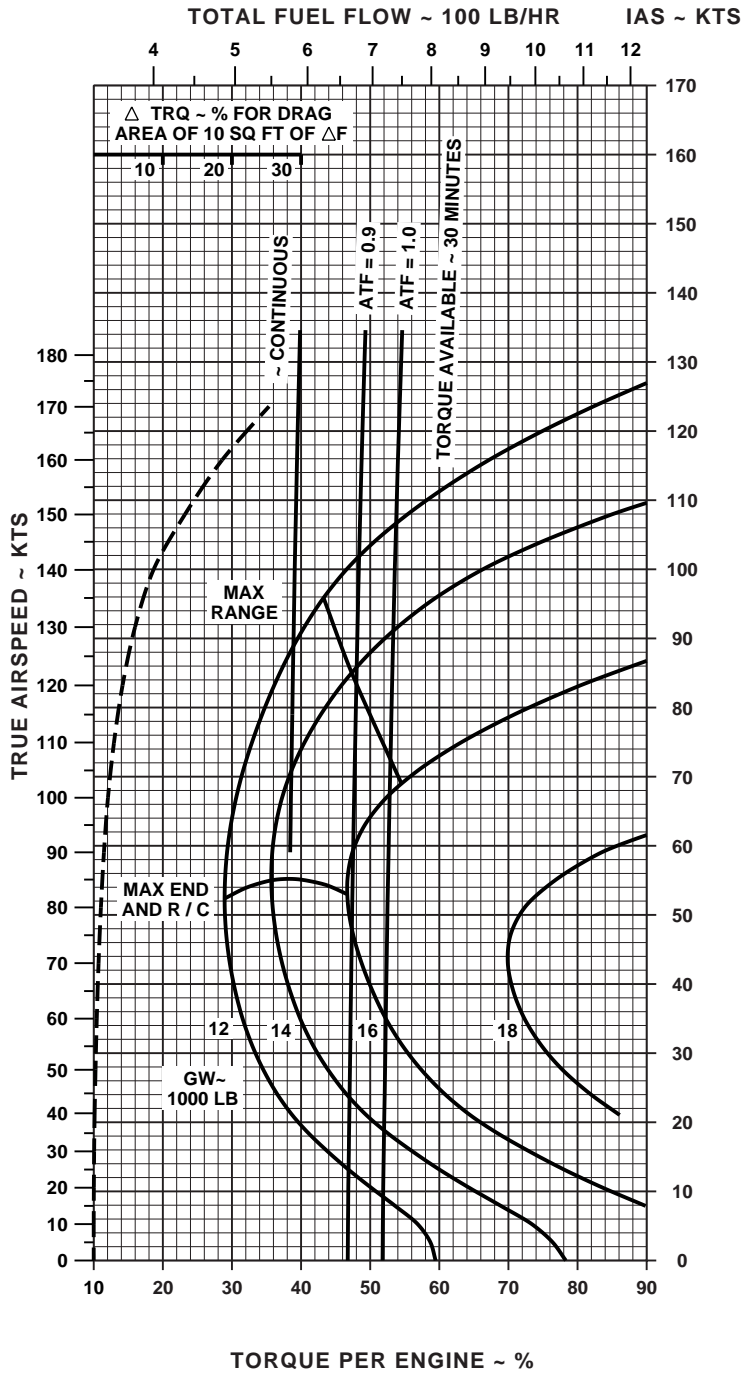

DATA BASE: FLIGHT TEST

AA0437
SA

Figure 7-23. Cruise - Pressure Altitude 16,000 Feet (Sheet 5 of 5)

CRUISE

PRESS ALT: 16000 FT

CRUISE
16000 FT
T700 (2)



-50°C

-40°C

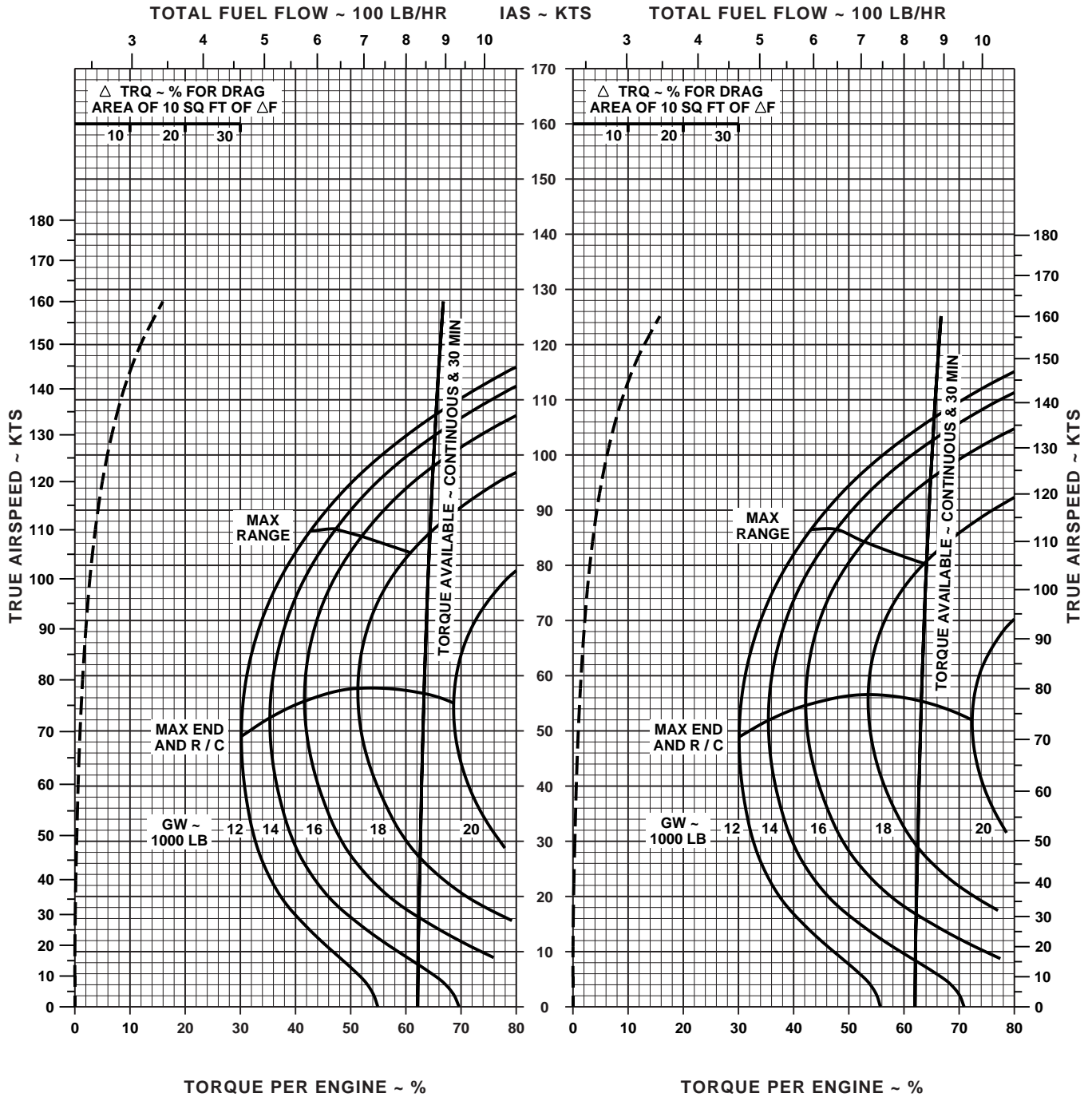

DATA BASE: FLIGHT TEST

AA0579
SA

Figure 7-24. Cruise High Drag - Pressure Altitude 16,000 Feet (Sheet 1 of 4)

CRUISE

PRESS ALT: 16000 FT

CRUISE
16000 FT
T700 (2)



-30°C

-20°C

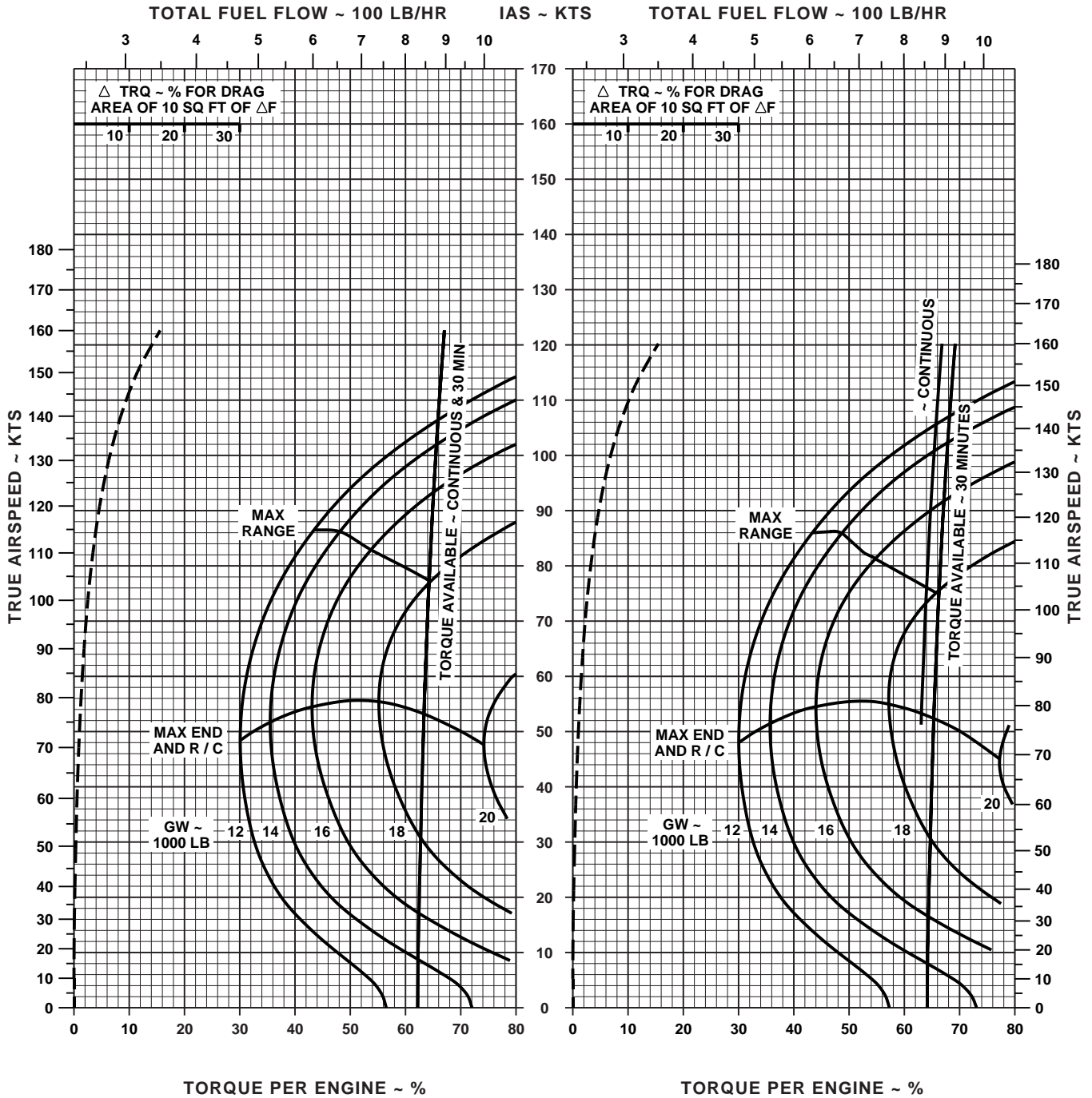

DATA BASE: FLIGHT TEST

AA0580
SA

Figure 7-24. Cruise High Drag - Pressure Altitude 16,000 Feet (Sheet 2 of 4)

CRUISE

PRESS ALT: 16000 FT

CRUISE
16000 FT
T700 (2)



-10°C

0°C

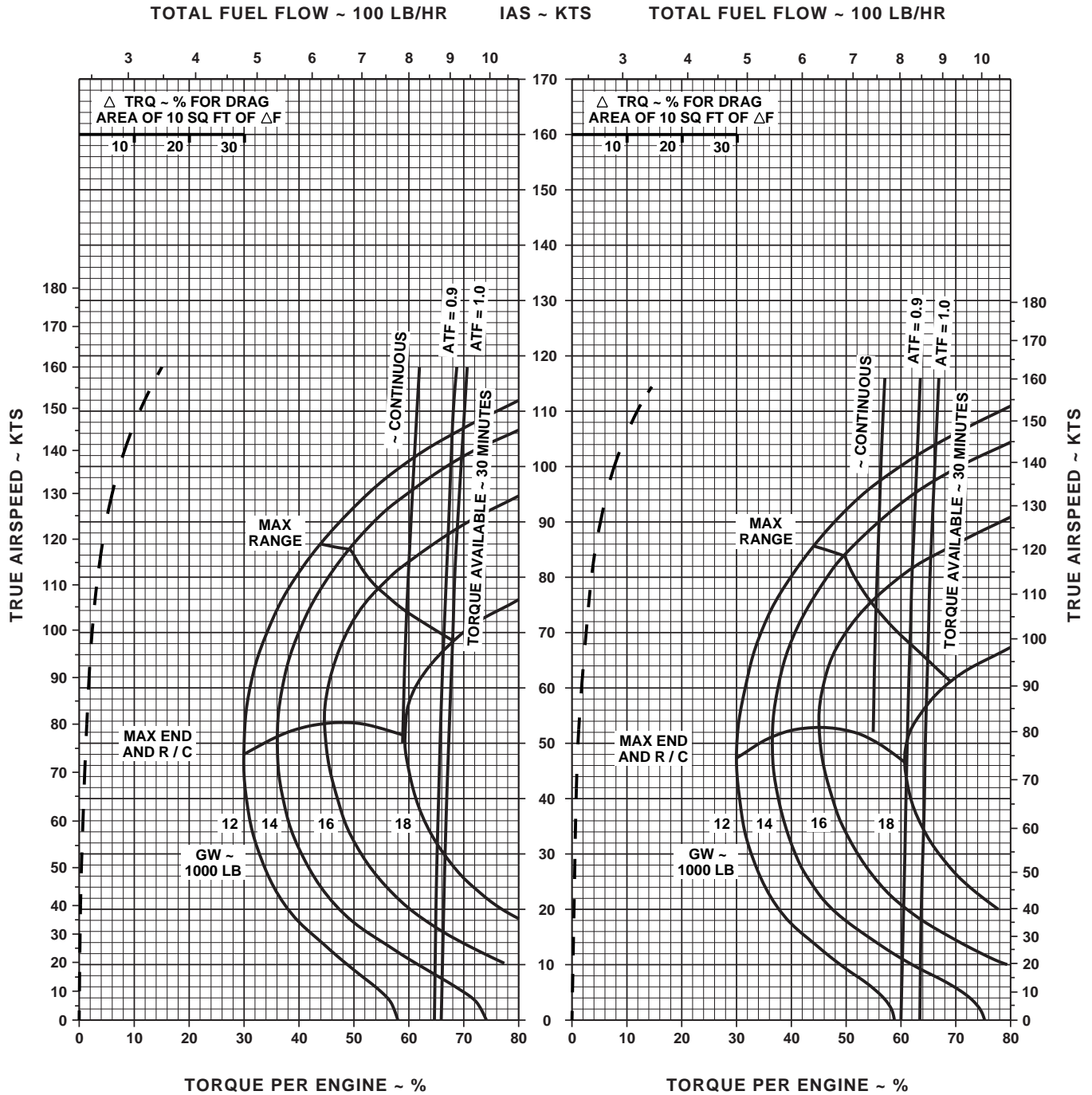

DATA BASE: FLIGHT TEST

AA0581
SA

Figure 7-24. Cruise High Drag - Pressure Altitude 16,000 Feet (Sheet 3 of 4)

CRUISE

PRESS ALT: 16000 FT

CRUISE
16000 FT
T700 (2)



10°C

20°C

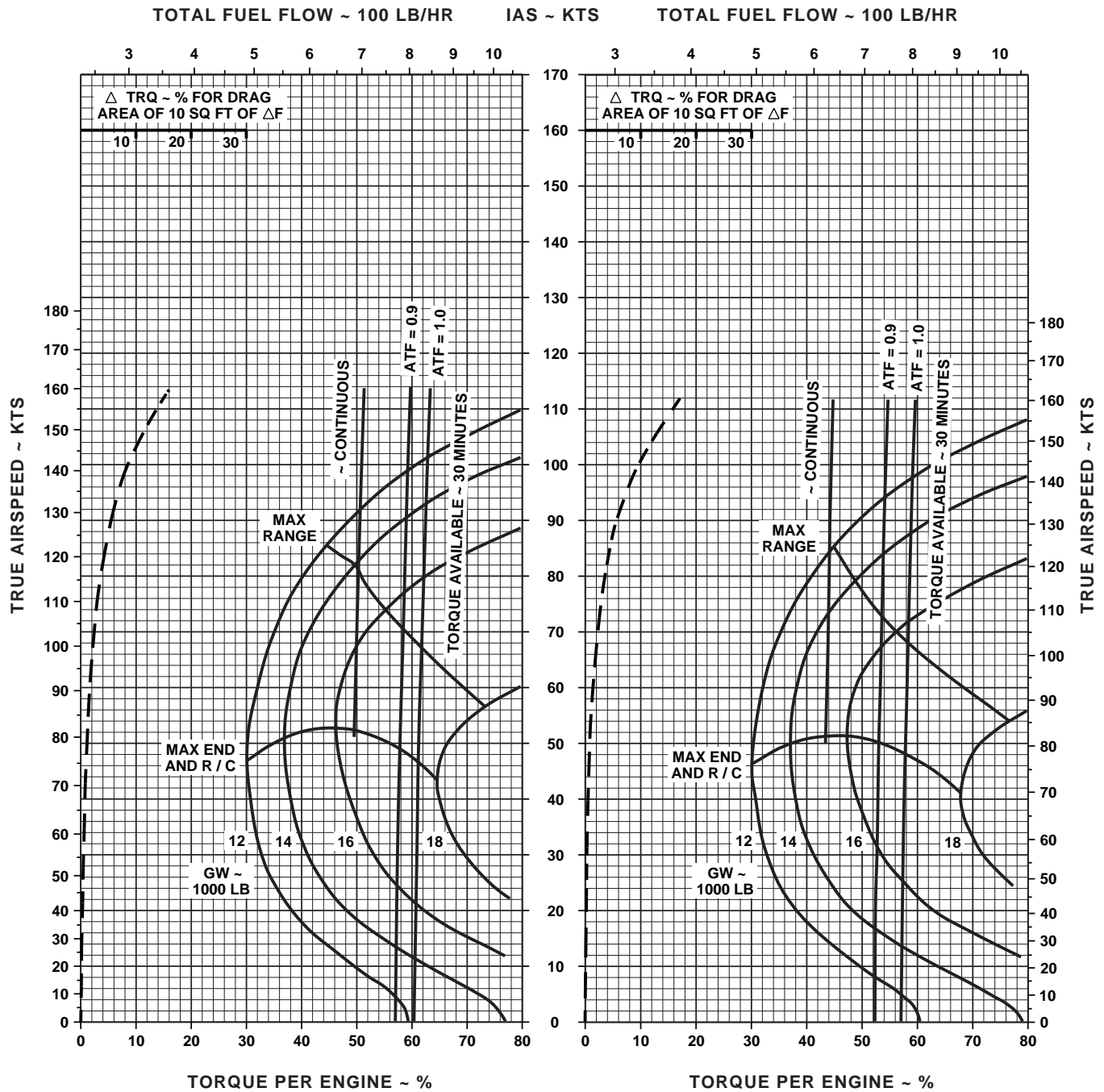

DATA BASE: FLIGHT TEST

AA0582
SA

Figure 7-24. Cruise High Drag - Pressure Altitude 16,000 Feet (Sheet 4 of 4)

CRUISE

CLEAN CONFIGURATION

PRESS ALT: 18000 FT

CRUISE
18000 FT
T700 (2)

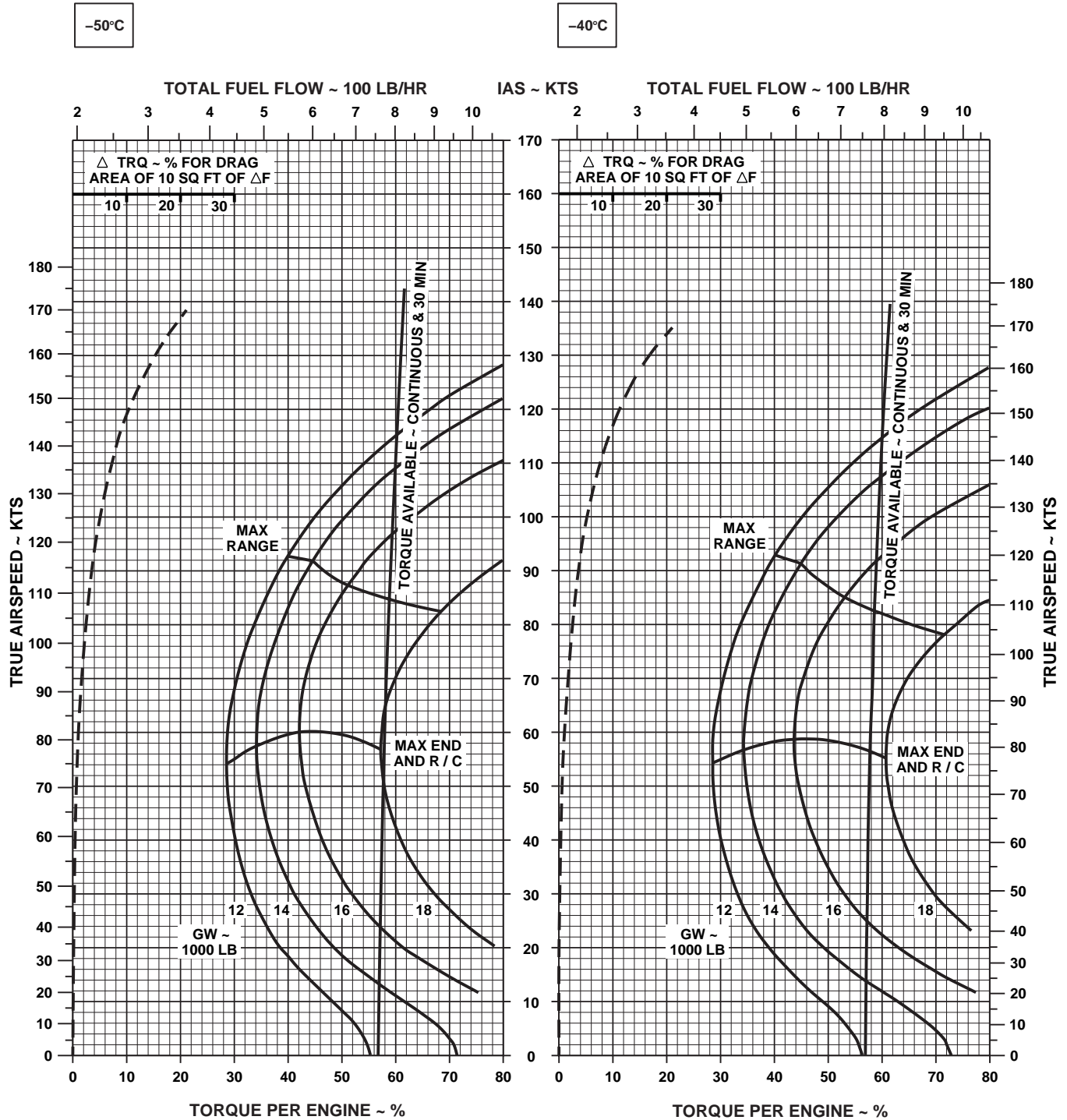

Figure 7-25. Cruise - Pressure Altitude 18,000 Feet (Sheet 1 of 5)

AA0440
SA

CRUISE

CLEAN CONFIGURATION

PRESS ALT: 18000 FT

CRUISE
18000 FT
T700 (2)

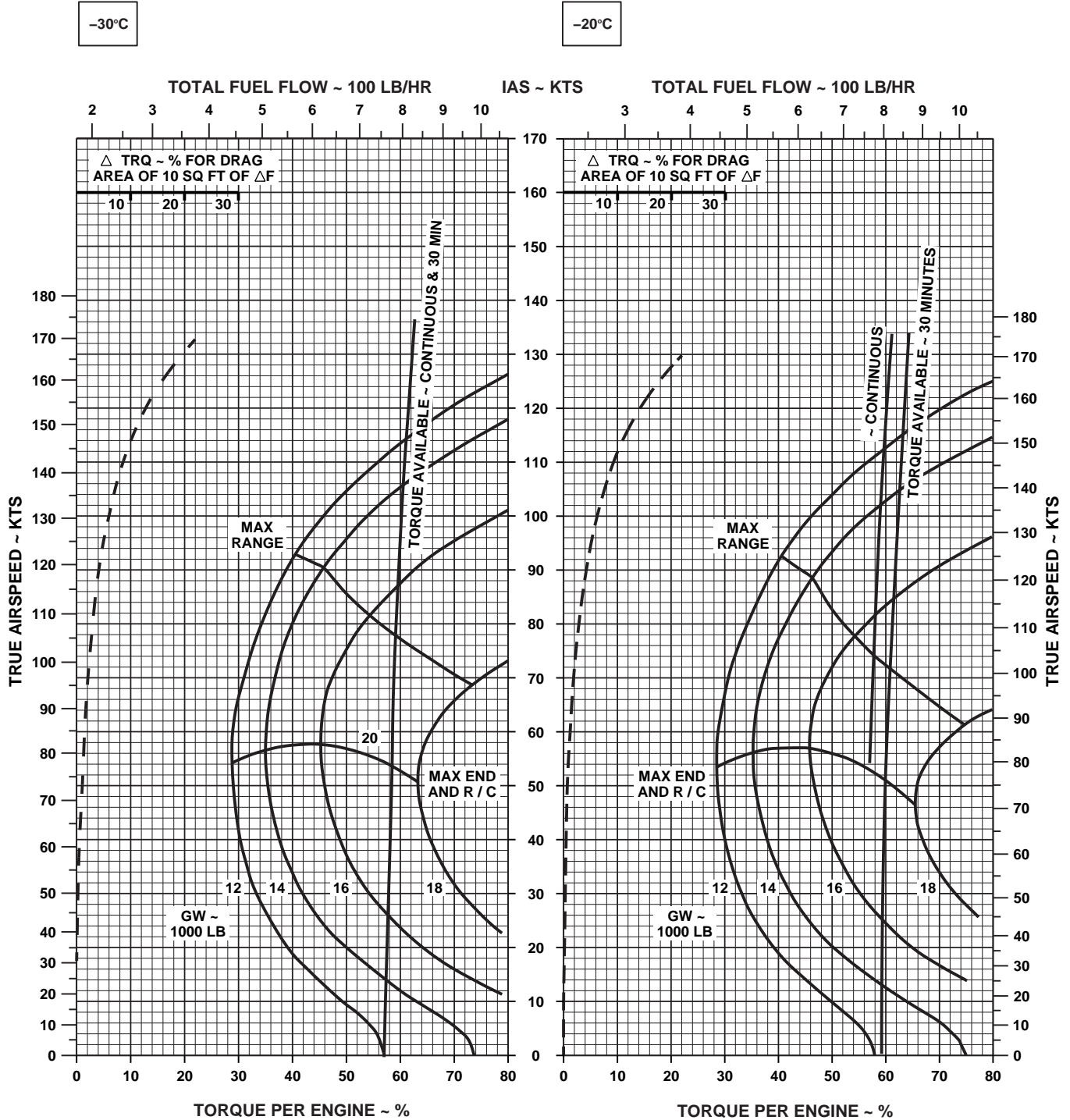

AA0439
SA

Figure 7-25. Cruise - Pressure Altitude 18,000 Feet (Sheet 2 of 5)

CRUISE

CLEAN CONFIGURATION

PRESS ALT: 18000 FT

CRUISE
18000 FT
T700 (2)

-10°C

0°C

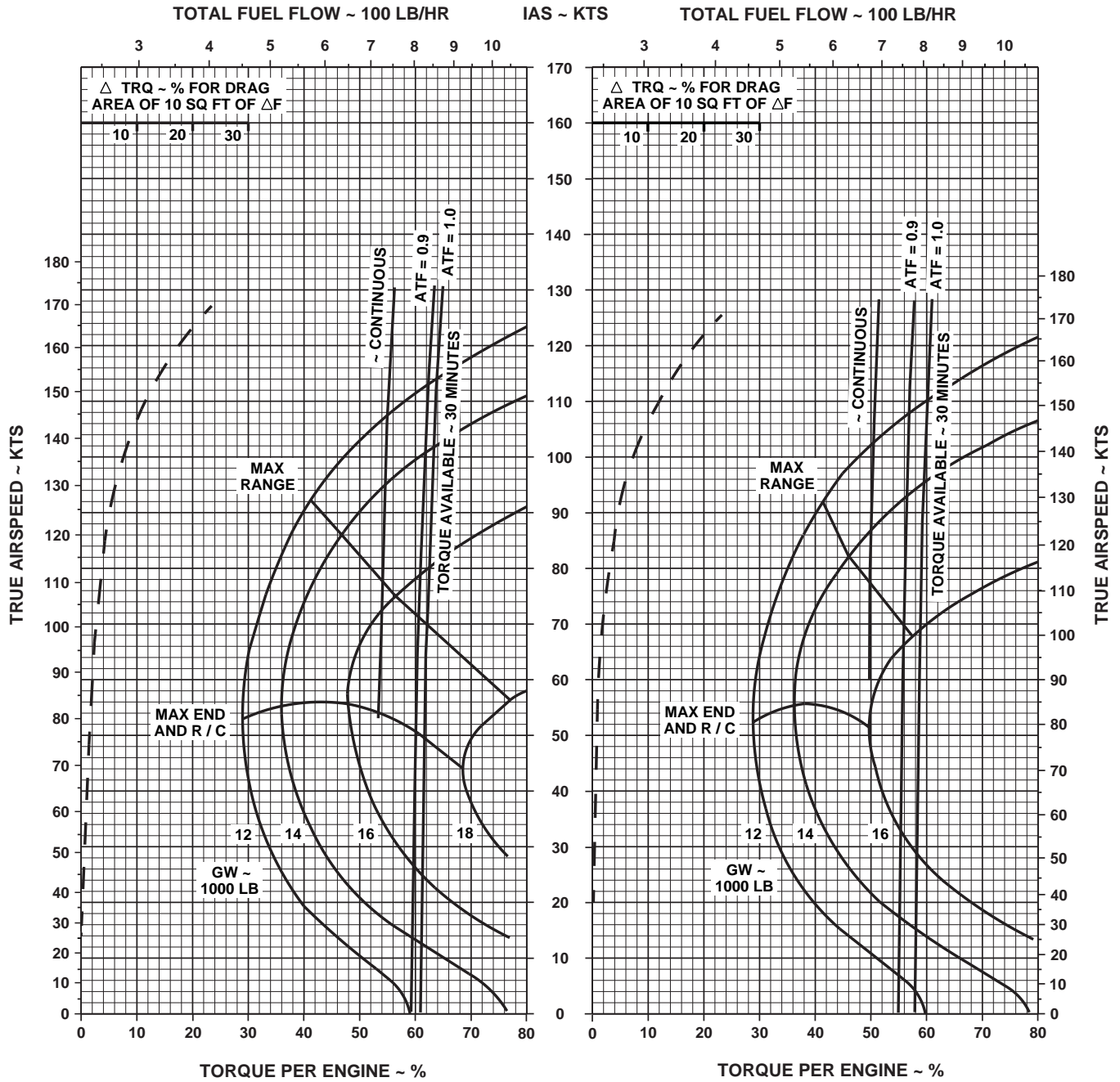

AA0438
SA

Figure 7-25. Cruise - Pressure Altitude 18,000 Feet (Sheet 3 of 5)

CRUISE

CLEAN CONFIGURATION

PRESS ALT: 18000 FT

CRUISE
18000 FT
T700 (2)

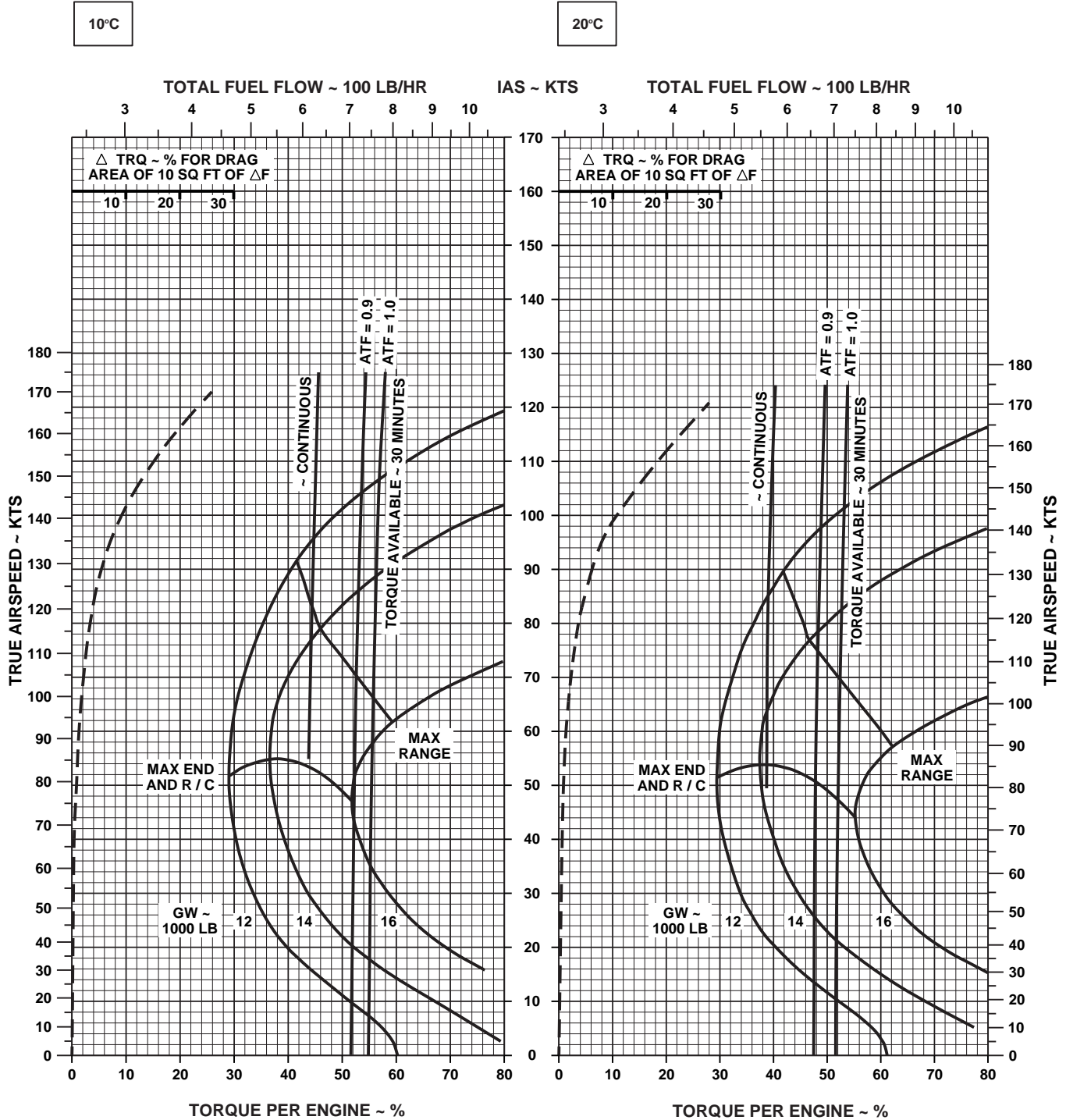

AA0441
SA

Figure 7-25. Cruise - Pressure Altitude 18,000 Feet (Sheet 4 of 5)

CRUISE

CLEAN CONFIGURATION

PRESS ALT: 18000 FT

CRUISE
18000 FT
T700 (2)

30°C

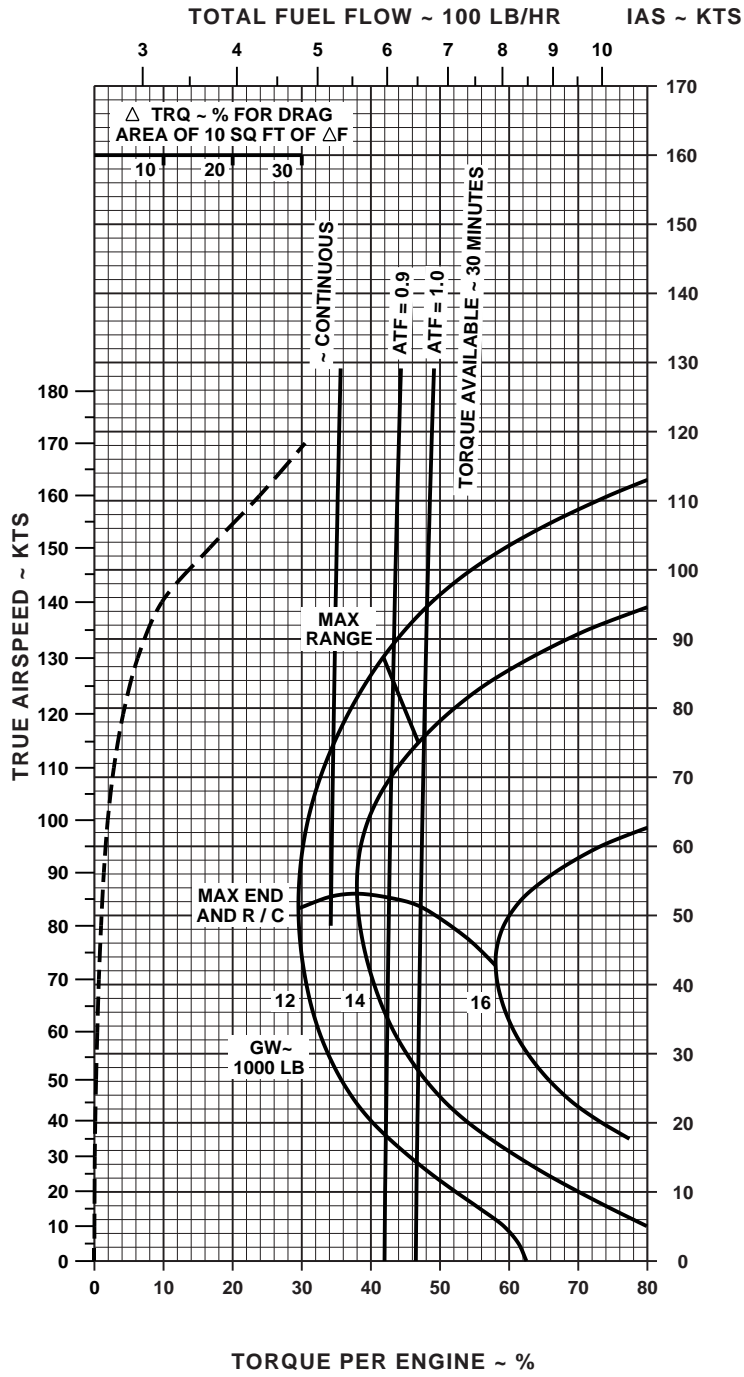

DATA BASIS: FLIGHT TEST

AA0442A
SA

Figure 7-25. Cruise - Pressure Altitude 18,000 Feet (Sheet 5 of 5)

CRUISE

PRESS ALT: 18000 FT

CRUISE
18000 FT
T700 (2)



-50°C

-40°C

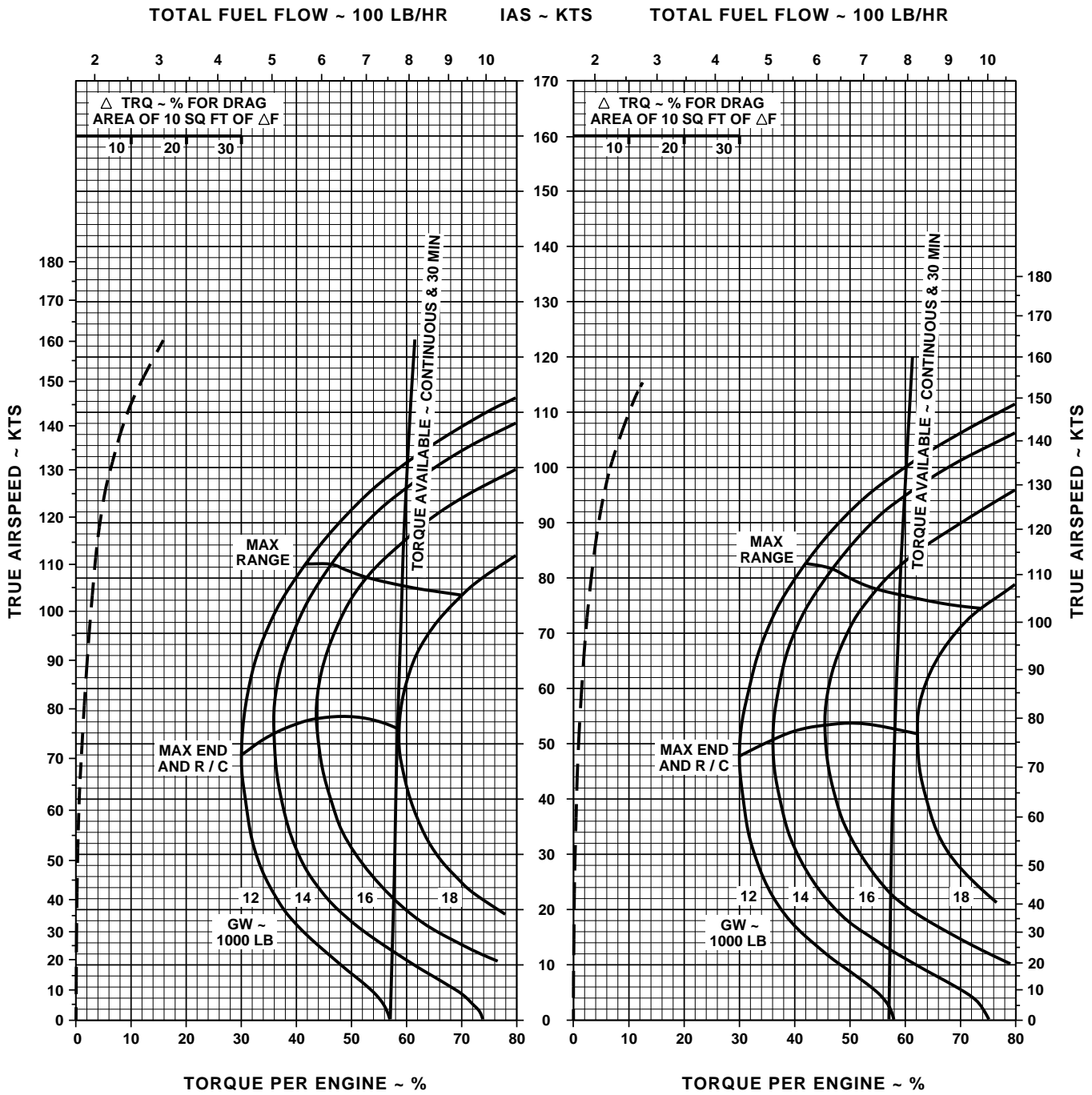

DATA BASE: FLIGHT TEST

AA0583
SA

Figure 7-26. Cruise High Drag - Pressure Altitude 18,000 Feet (Sheet 1 of 4)

CRUISE

PRESS ALT: 18000 FT

CRUISE
18000 FT
T700 (2)



-30°C

-20°C

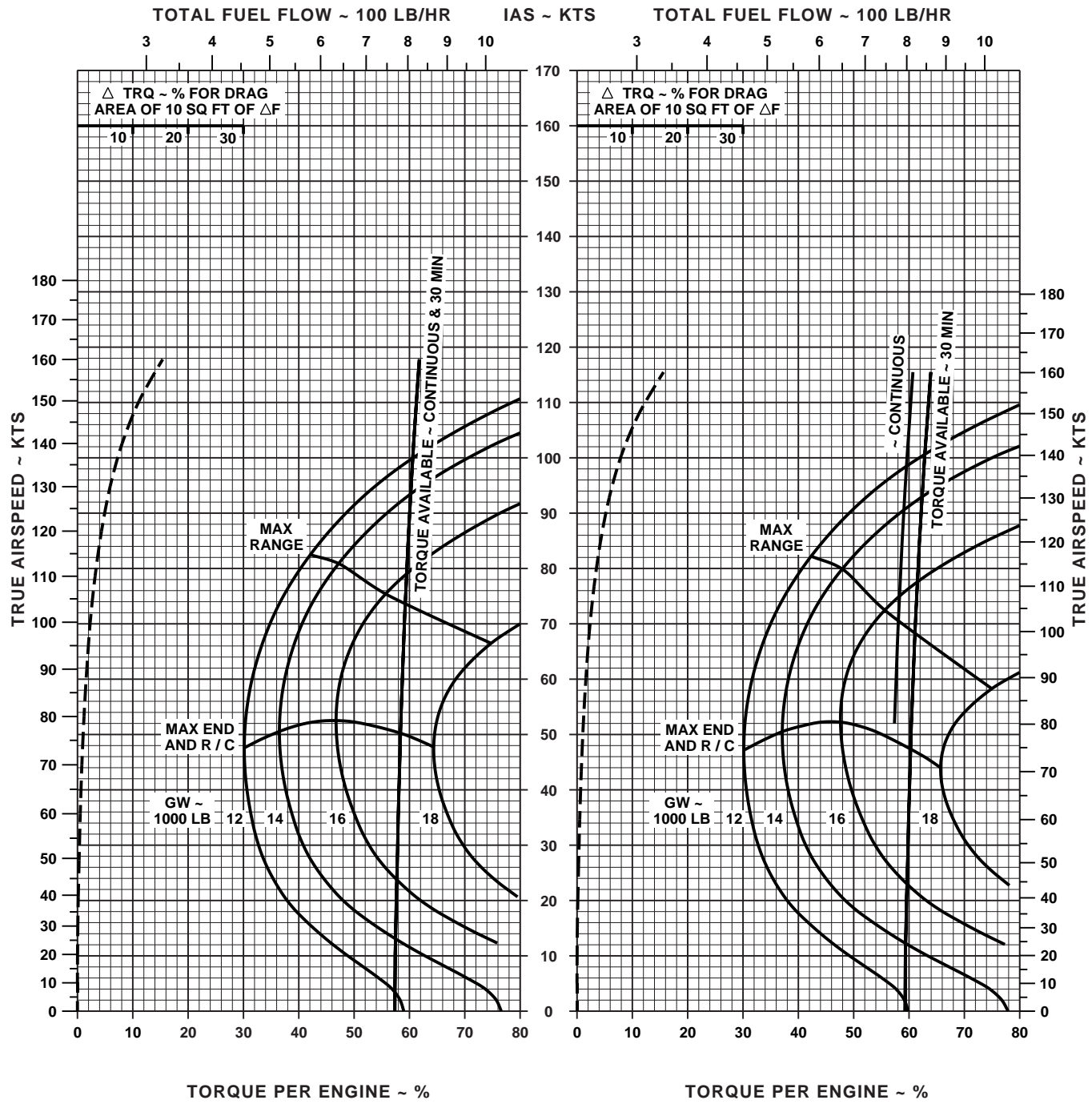

DATA BASE: FLIGHT TEST

AA0584 SA

Figure 7-26. Cruise High Drag - Pressure Altitude 18,000 Feet (Sheet 2 of 4)

CRUISE

PRESS ALT: 18000 FT

CRUISE
18000 FT
T700 (2)



-10°C

0°C

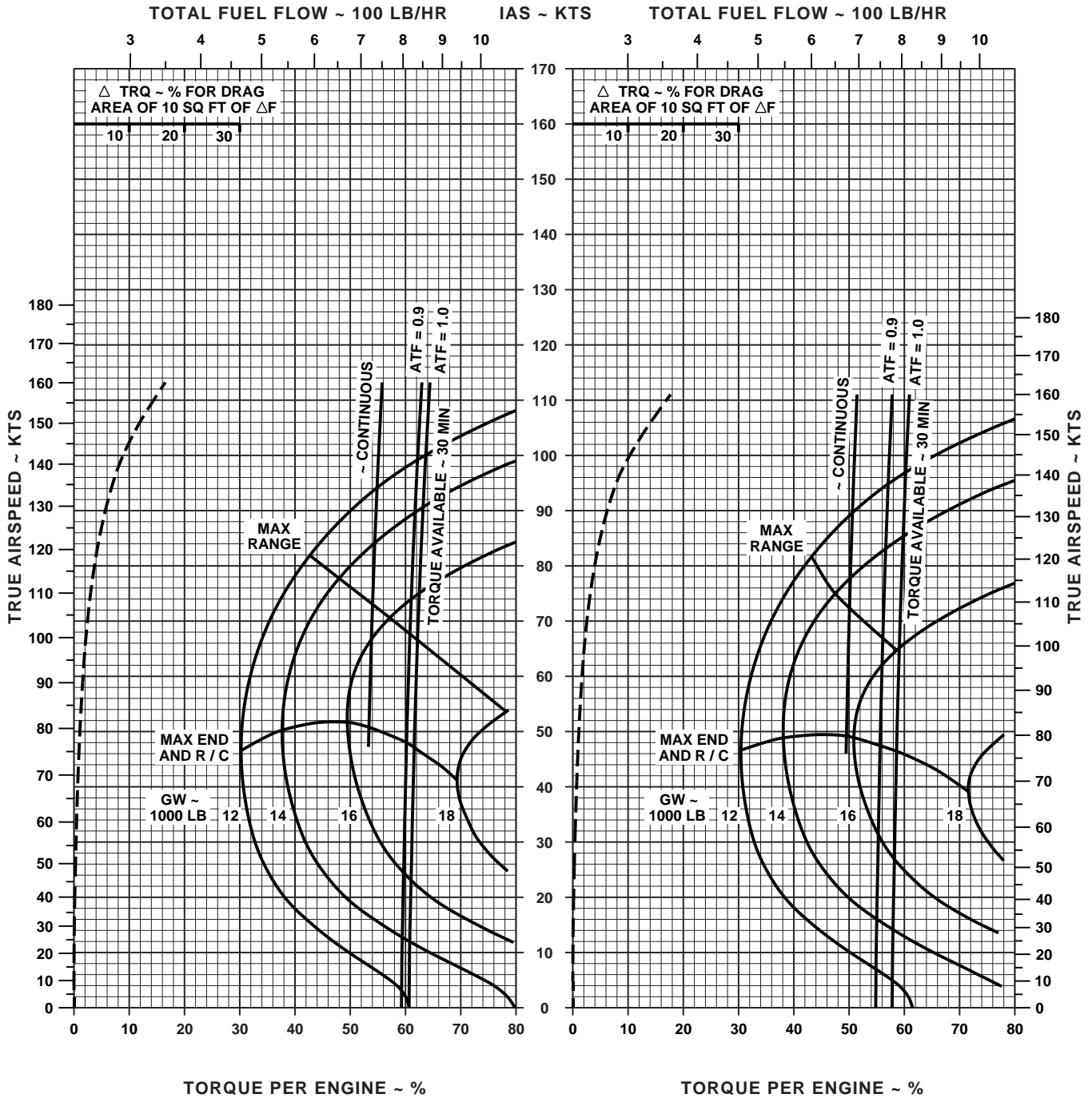

DATA BASE: FLIGHT TEST

AA0585
SA

Figure 7-26. Cruise High Drag - Pressure Altitude 18,000 Feet (Sheet 3 of 4)

CRUISE

PRESS ALT: 18000 FT

CRUISE
18000 FT
T700 (2)



10°C

20°C

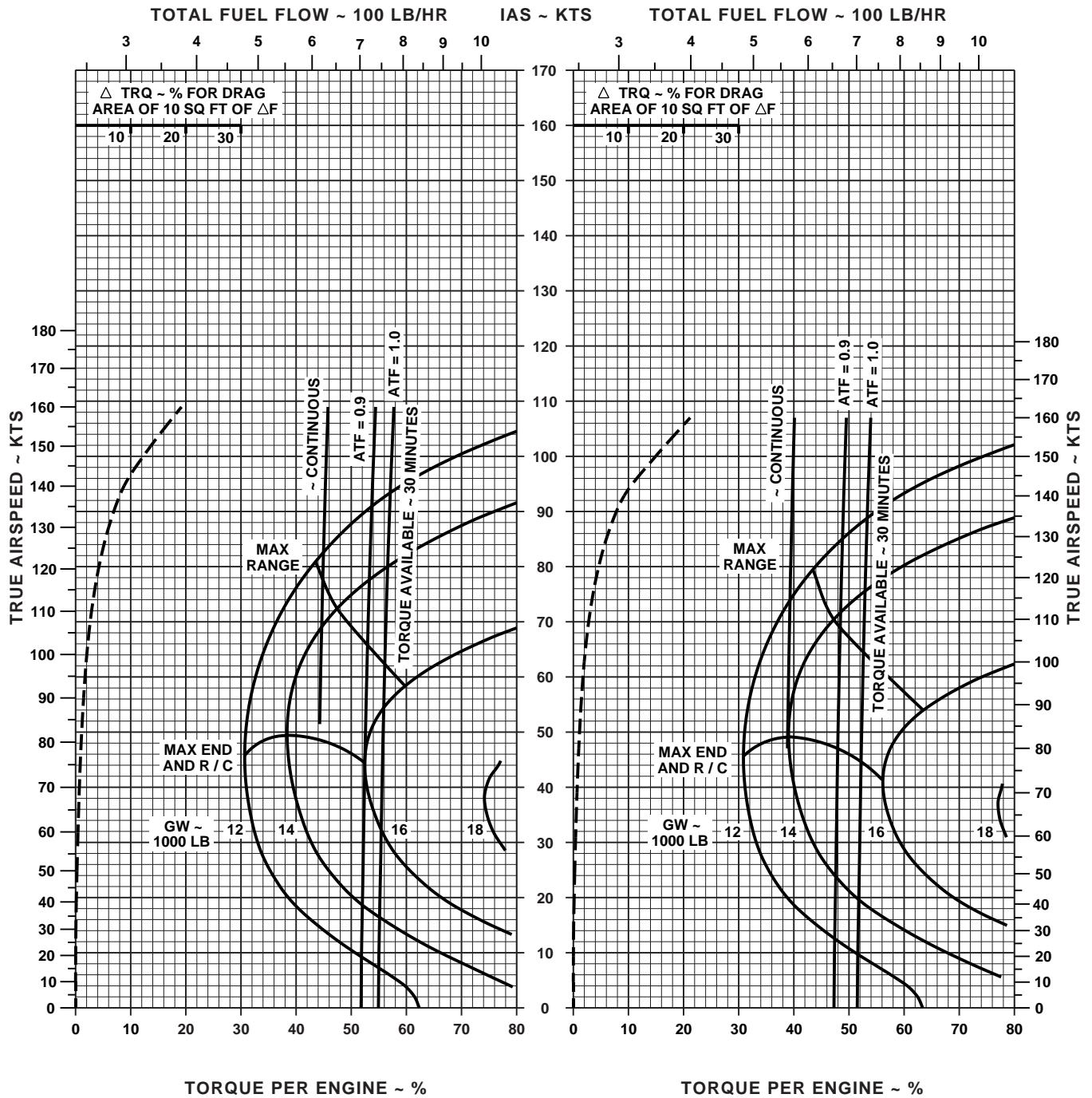

DATA BASE: FLIGHT TEST

AA0586
SA

Figure 7-26. Cruise High Drag - Pressure Altitude 18,000 Feet (Sheet 4 of 4)

CRUISE

CLEAN CONFIGURATION

PRESS ALT: 20000 FT

CRUISE
20000 FT
T700 (2)

-50°C

-40°C

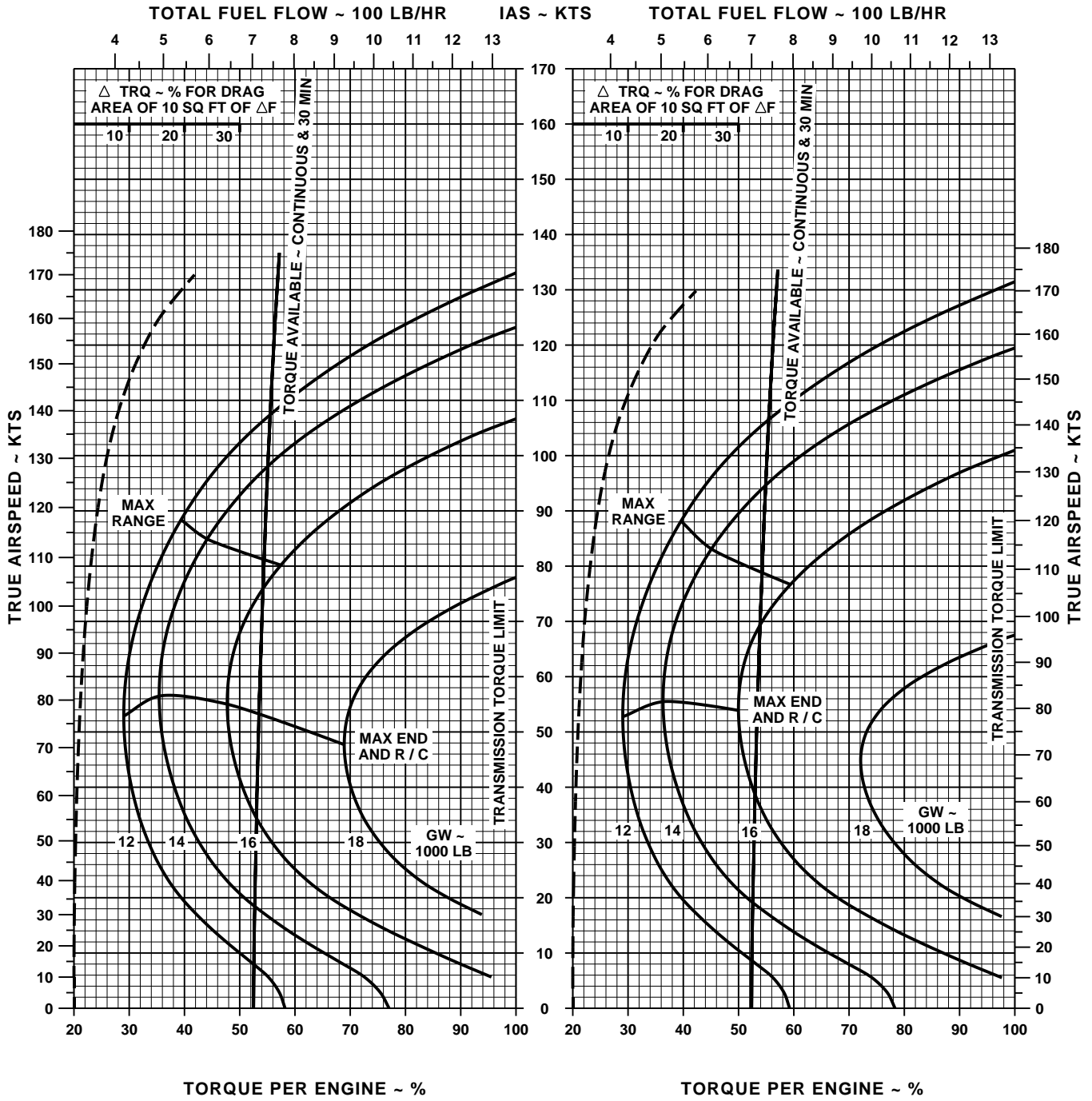

DATA BASE: FLIGHT TEST

AA0445
SA

Figure 7-27. Cruise - Pressure Altitude 20,000 Feet (Sheet 1 of 4)

CRUISE

CLEAN CONFIGURATION

PRESS ALT: 20000 FT

CRUISE
20000 FT
T700 (2)

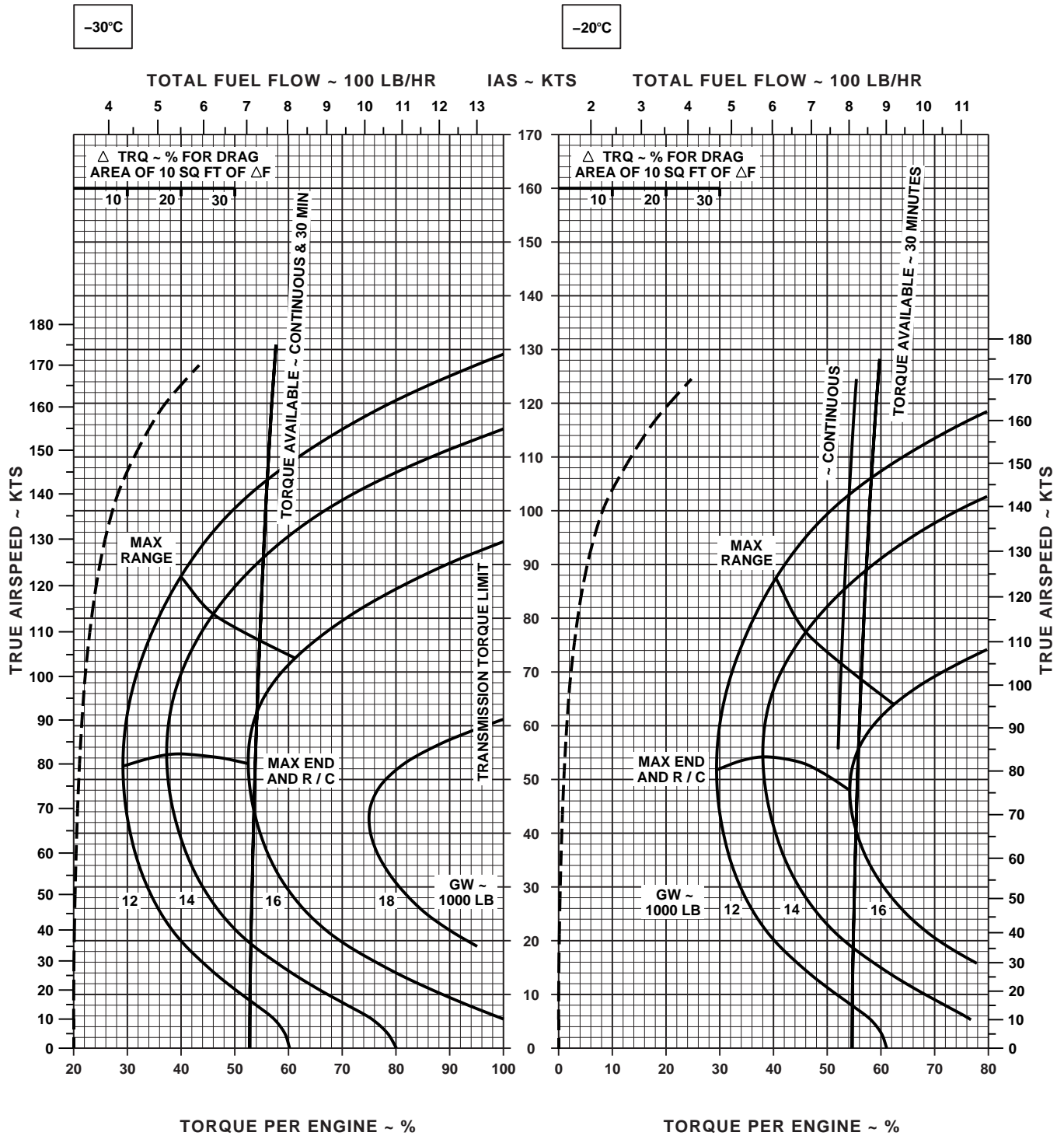

DATA BASE: FLIGHT TEST

AA0444
SA

Figure 7-27. Cruise - Pressure Altitude 20,000 Feet (Sheet 2 of 4)

CRUISE CLEAN CONFIGURATION PRESS ALT: 20000 FT

CRUISE
20000 FT
T700 (2)

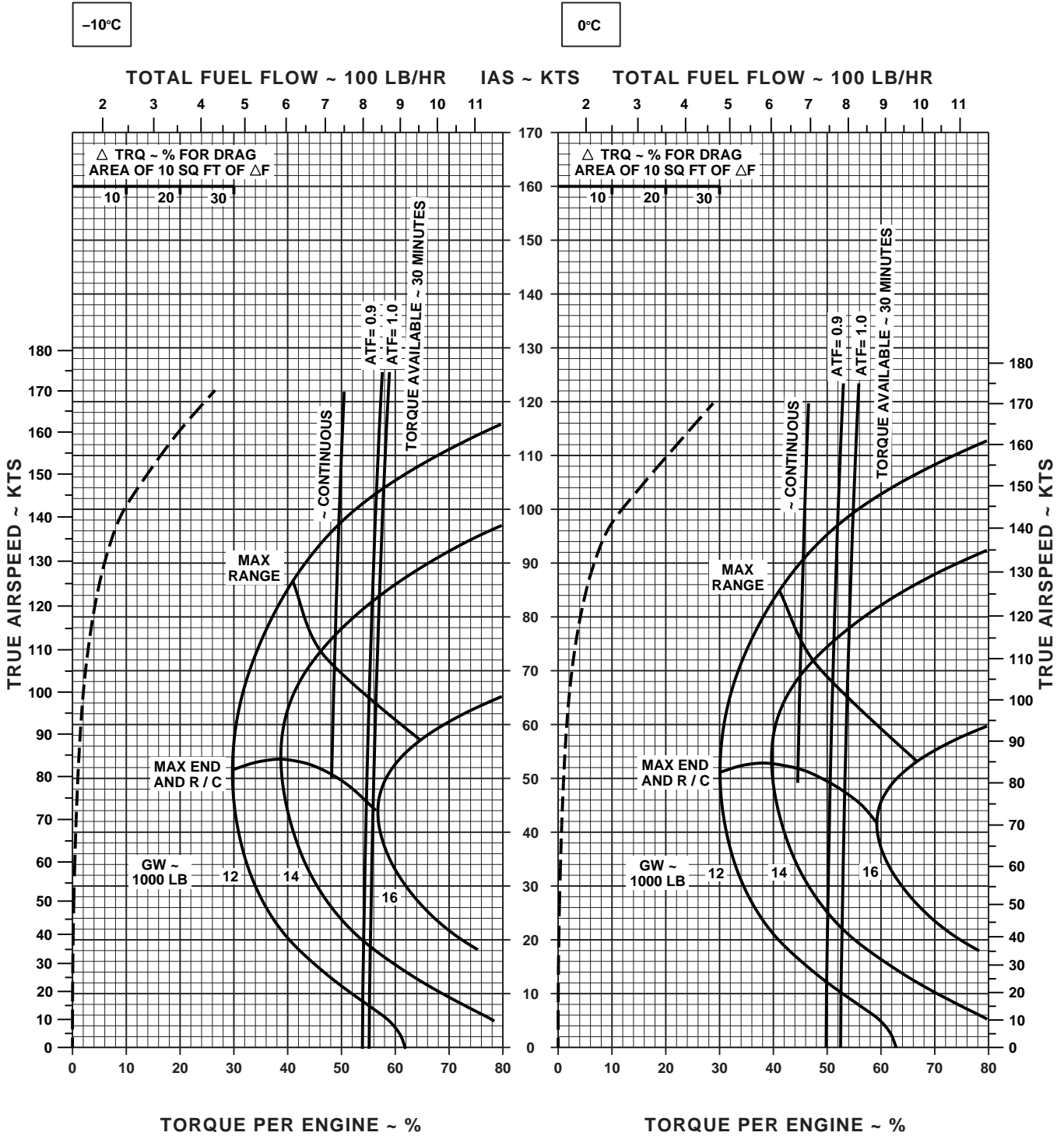

DATA BASE: FLIGHT TEST

AA0443A
SA

Figure 7-27. Cruise - Pressure Altitude 20,000 Feet (Sheet 3 of 4)

CRUISE

CLEAN CONFIGURATION

PRESS ALT: 20000 FT

CRUISE
20000 FT
T700 (2)

10°C

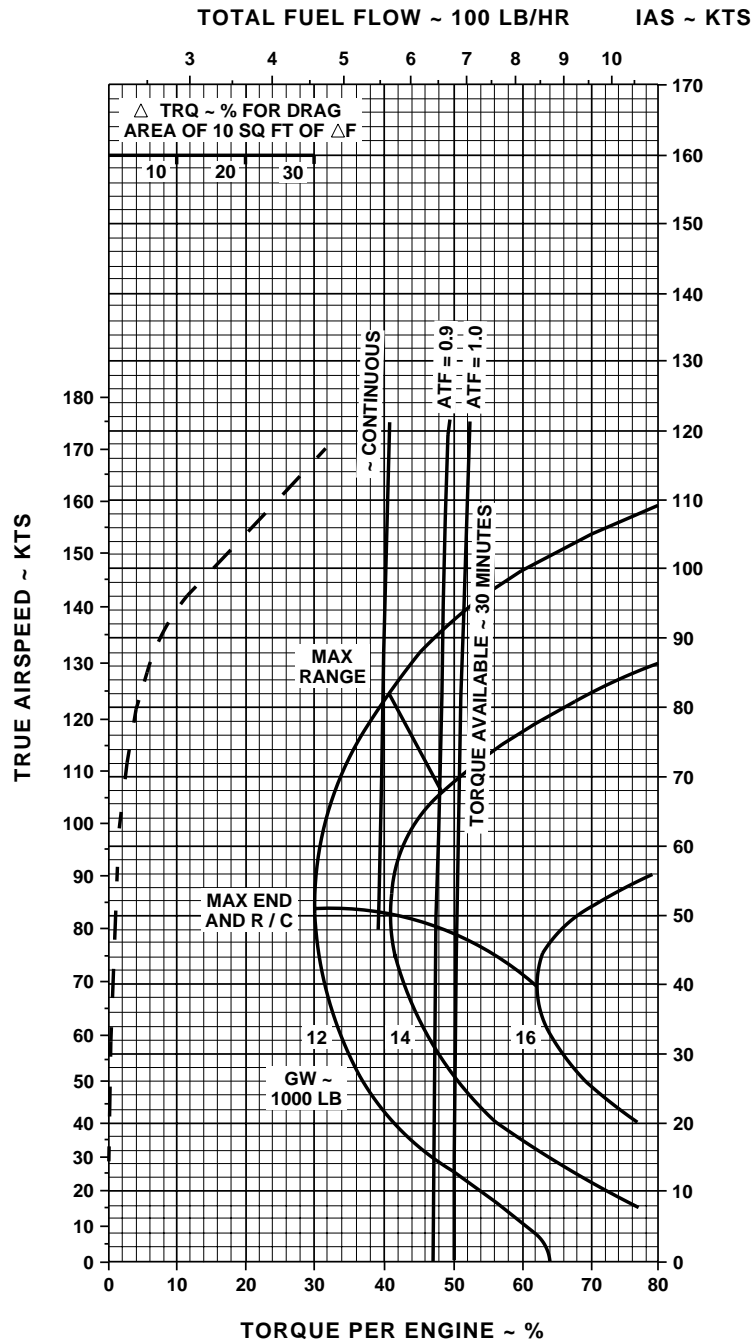

AA0446
SA

Figure 7-27. Cruise - Pressure Altitude 20,000 Feet (Sheet 4 of 4)

CRUISE

PRESS ALT: 20000 FT

CRUISE
20000 FT
T700 (2)



-50°C

-40°C

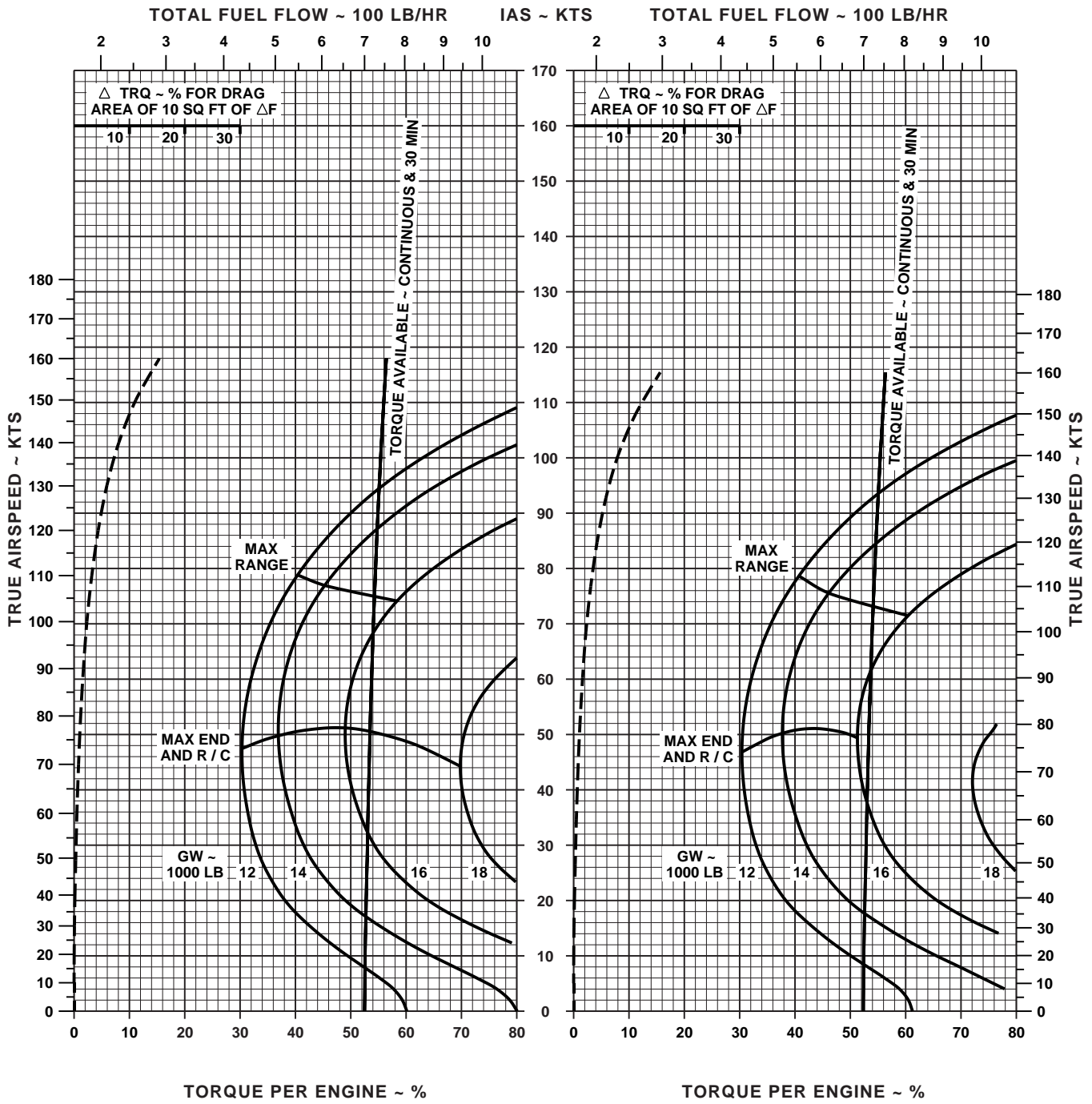

DATA BASE: FLIGHT TEST

AA0587
SA

Figure 7-28. Cruise High Drag - Pressure Altitude 20,000 Feet (Sheet 1 of 4)

CRUISE

PRESS ALT: 20000 FT

CRUISE
20000 FT
T700 (2)



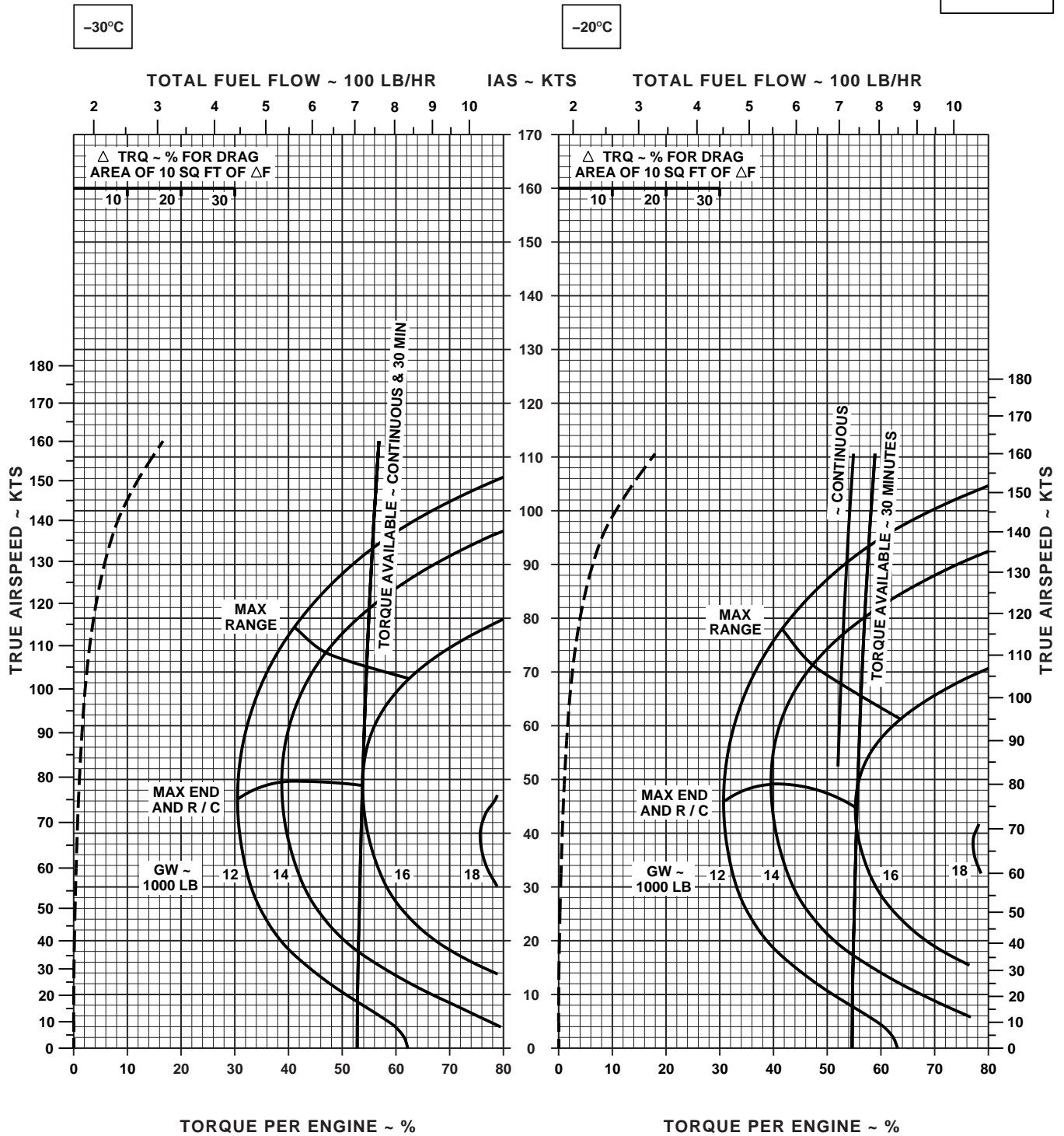

DATA BASE: FLIGHT TEST

AA0588
SA

Figure 7-28. Cruise High Drag - Pressure Altitude 20,000 Feet (Sheet 2 of 4)

CRUISE

PRESS ALT: 20000 FT

CRUISE
20000 FT
T700 (2)



-10°C

0°C

TOTAL FUEL FLOW ~ 100 LB/HR

IAS ~ KTS

TOTAL FUEL FLOW ~ 100 LB/HR

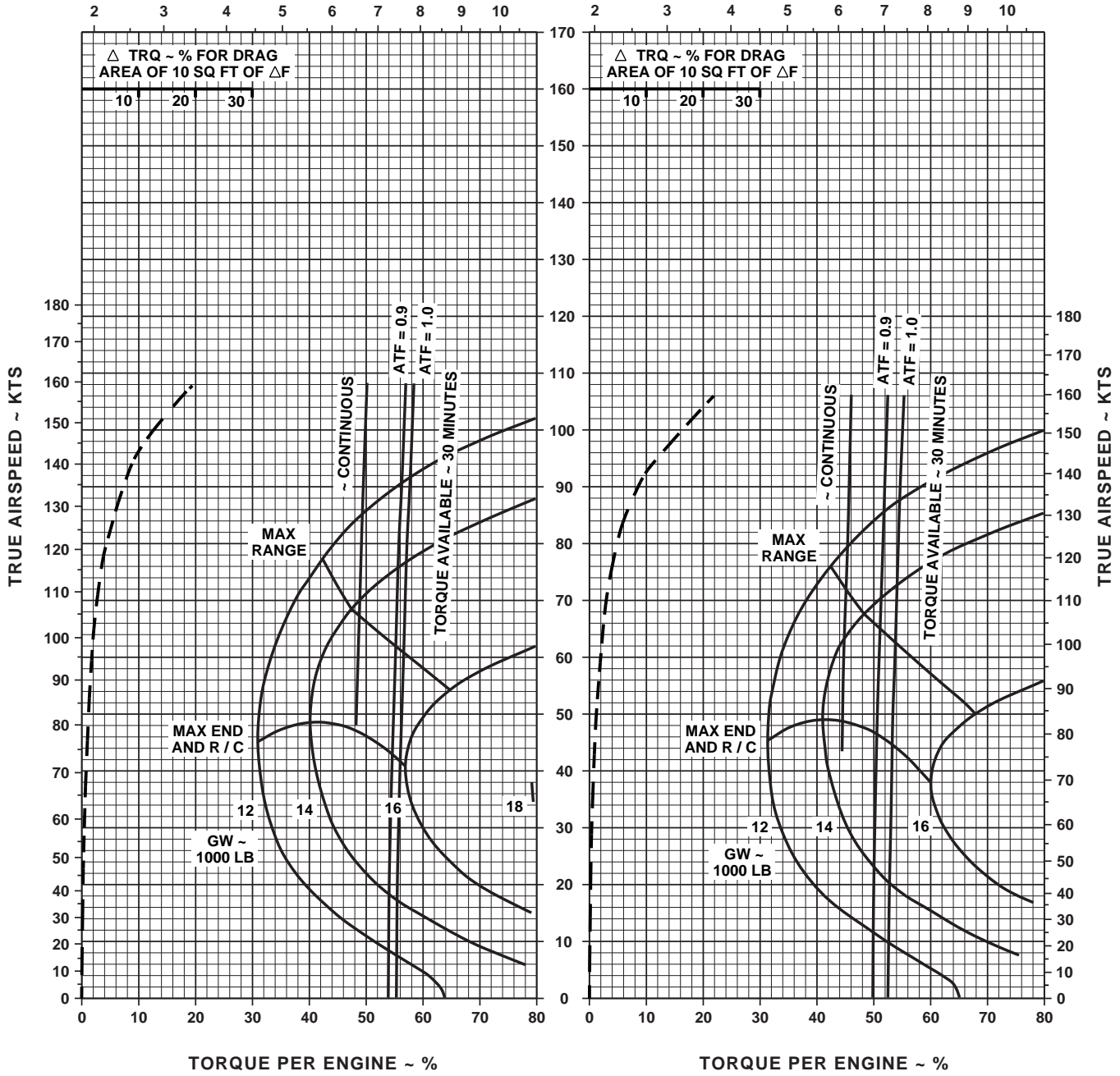

DATA BASE: FLIGHT TEST

AA0589
SA

Figure 7-28. Cruise High Drag - Pressure Altitude 20,000 Feet (Sheet 3 of 4)

CRUISE

PRESS ALT: 20000 FT

CRUISE
20000 FT
T700 (2)



10°C

TOTAL FUEL FLOW ~ 100 LB/HR

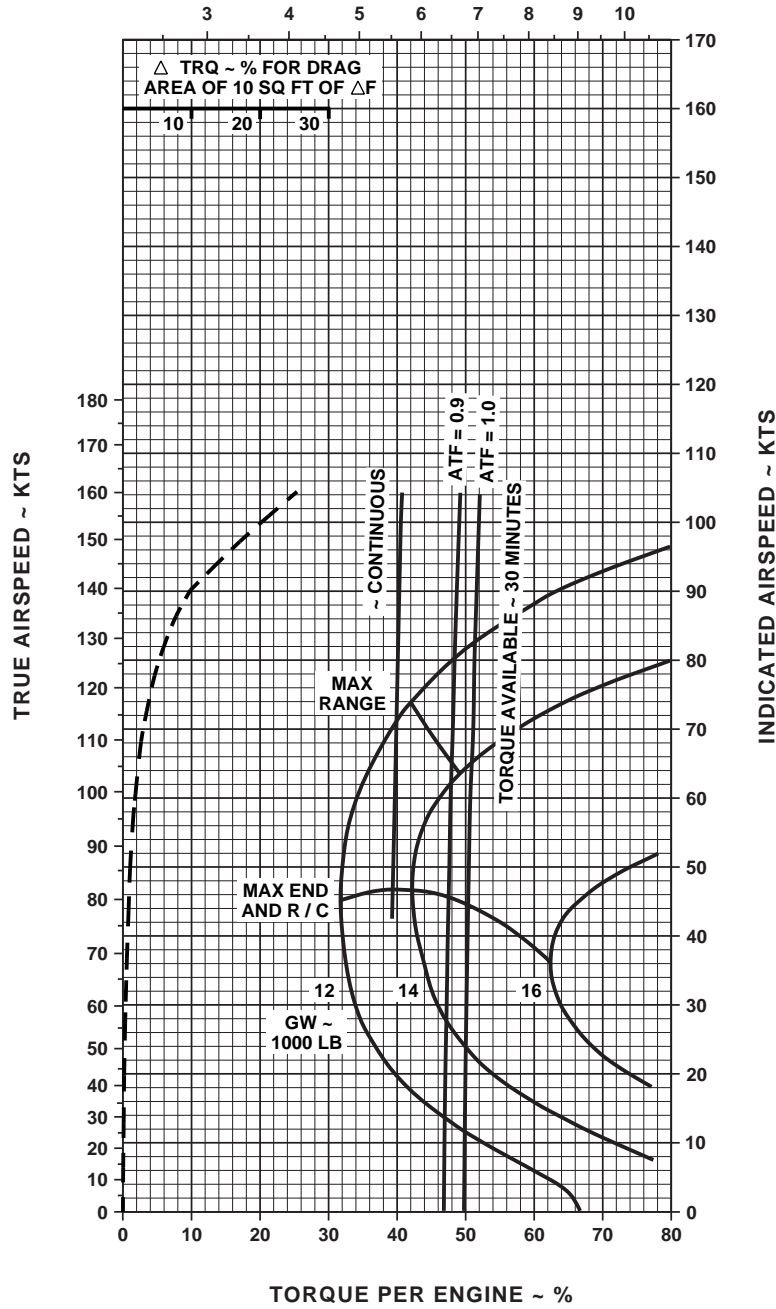

DATA BASE: FLIGHT TEST

AA0590
SA

Figure 7-28. Cruise High Drag - Pressure Altitude 20,000 Feet (Sheet 4 of 4)

Section V OPTIMUM CRUISE

7.19 OPTIMUM RANGE CHARTS.

This section presents a method to optimize cruise performance for long range missions when the altitudes flown are not restricted by other requirements. The optimum altitude for maximum range chart (Figure 7-29) provides the pressure altitude at which to cruise to obtain the maximum possible range for any gross weight and FAT conditions.

The altitude determined for optimum range may also be used for optimum endurance. Enter the chart at a current cruise or takeoff temperature condition and move along the temperature guide lines to the anticipated gross weight for cruise and obtain the optimum pressure altitude. Turn to the cruise chart closest to the altitude and temperature predicted by the optimum range chart for specific cruise information. The use of this chart is shown by the example.

OPTIMUM RANGE

CLEAN CONFIGURATION 100% RPM R HIRSS (BAFFLES INSTALLED)

EXAMPLE

WANTED:

CRUISE ALTITUDE FOR OPTIMUM RANGE
AND CORRESPONDING CRUISE CHART FOR
FLIGHT CONDITIONS

KNOWN:

REFERENCE CONDITIONS OF:
PRESSURE ALTITUDE = 1,500 FT
FAT = 24 °C
GROSS WEIGHT = 16,500 LB

METHOD:

ENTER CHART AT FAT (24 °C), MOVE RIGHT
TO REFERENCE / OPTIMUM PRESSURE ALTITUDE
(1,500 FT). MOVE PARALLEL WITH THE
TEMPERATURE TREND LINES TO AIRCRAFT
GROSS WEIGHT (16,500 LB). MOVE LEFT OR
RIGHT PARALLELING THE TEMPERATURE TREND
LINE TO NEAREST EVEN THOUSAND
REFERENCE / OPTIMUM PRESSURE ALTITUDE
LINE (12,000). MOVE LEFT TO FREE AIR
TEMPERATURE LINE (2.5 °C), MOVE UP OR DOWN
TO NEAREST TEN VALUE ON THE FREE AIR
TEMPERATURE SCALE (0 °C).

SELECT CRUISE CHART WITH ALTITUDE AND
TEMPERATURE DATA AT THE NEAREST
REFERENCE / OPTIMUM PRESSURE ALTITUDE
(12,000 FT) AND THE NEAREST TEN DEGREE
FREE AIR TEMPERATURE (0 °C).

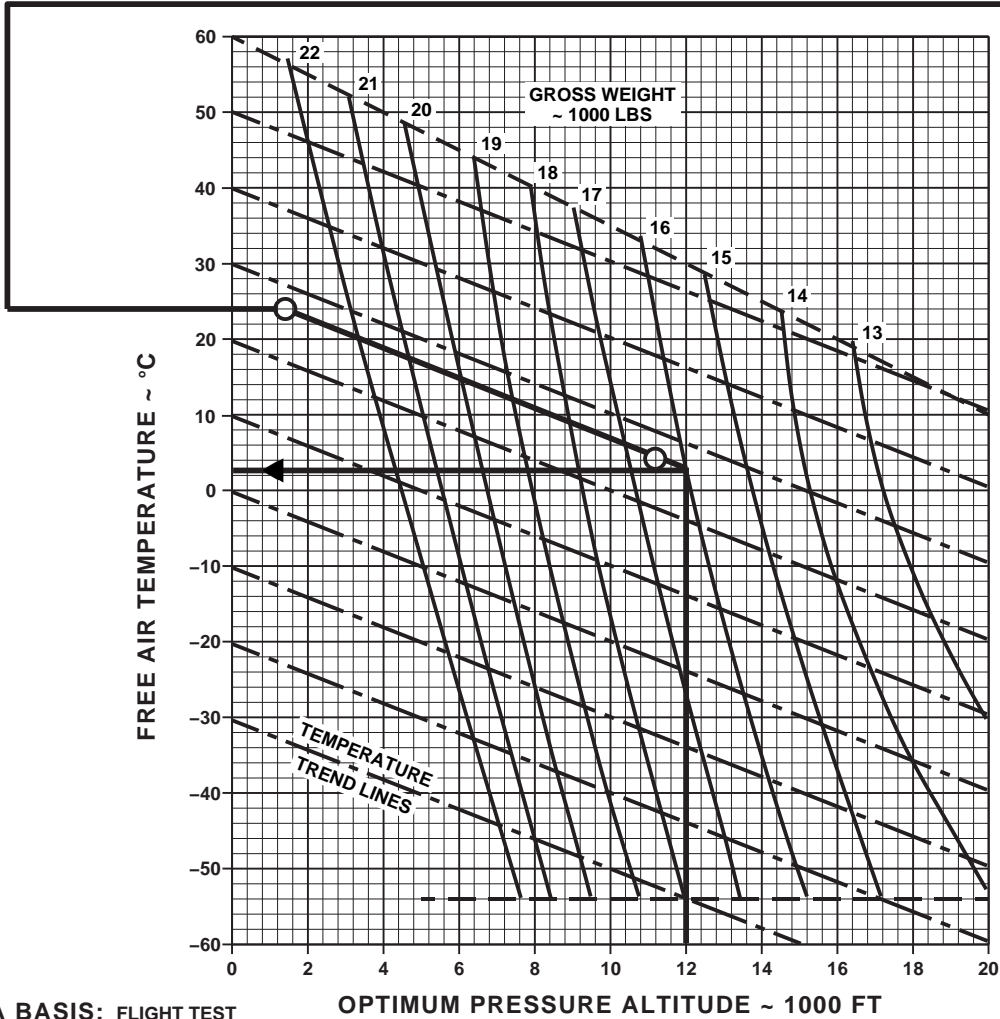

DATA BASIS: FLIGHT TEST

OPTIMUM PRESSURE ALTITUDE ~ 1000 FT

AA0683_1B
SA

Figure 7-29. Optimum Altitude For Maximum Range (Sheet 1 of 2)

OPTIMUM RANGE

HIGH DRAG CONFIGURATION 100% RPM R HIRSS (BAFFLES INSTALLED)

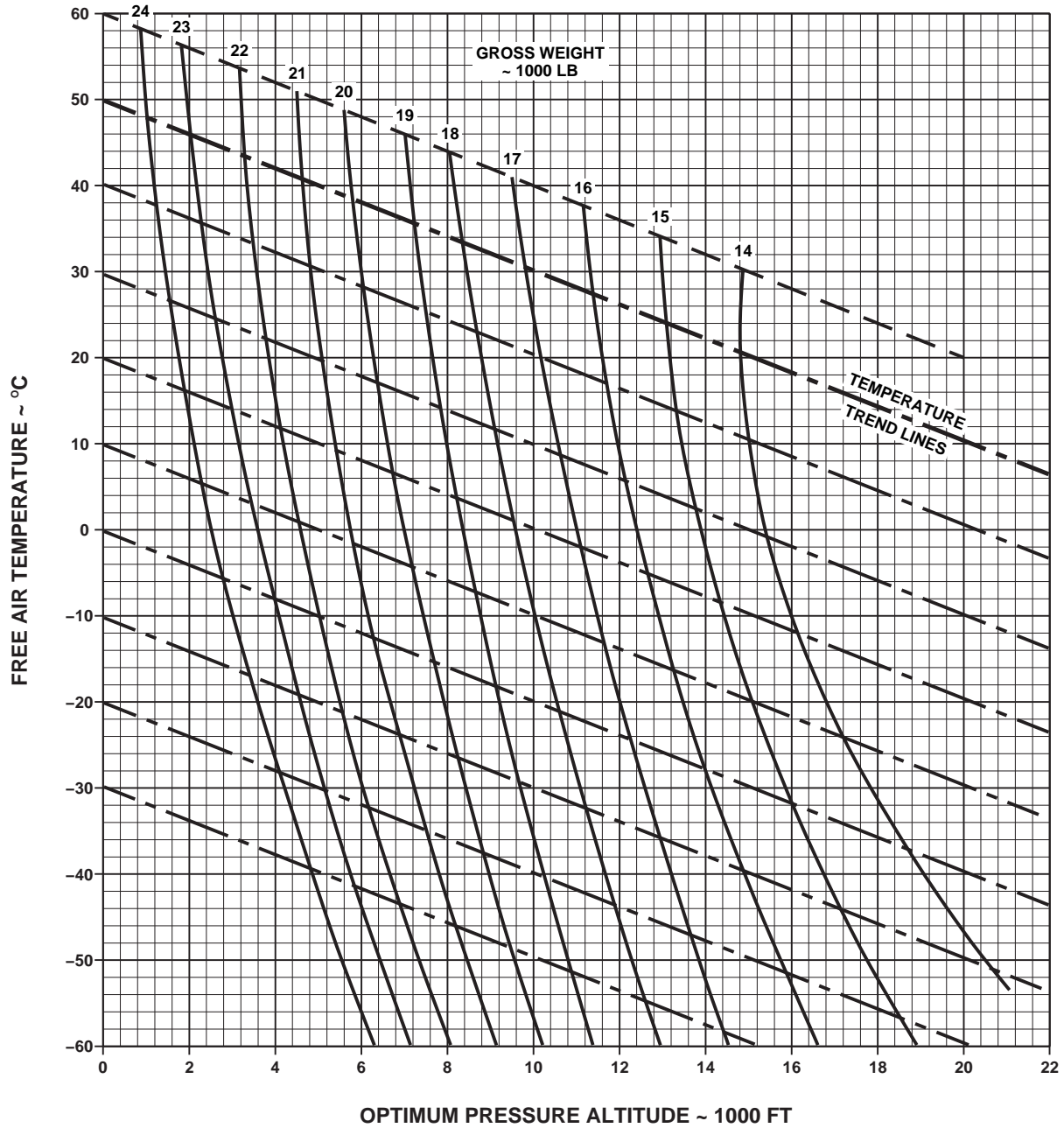

DATA BASIS: FLIGHT TEST

AA0683_2B
SA

Figure 7-29. Optimum Altitude For Maximum Range (Sheet 2 of 2)

Section VI DRAG

7.20 EXTERNAL LOAD DRAG CHART.

The general shapes of typical external loads are shown on Figure 7-30 as a function of the load frontal area. The frontal area is combined with the typical drag coefficient of the general shapes to obtain a drag multiplying factor for use with the 10 sq. ft. drag scale on each cruise chart. The ΔTRQ % value obtained from the cruise chart is multiplied by the drag multiplying factor and added to indicated torque to obtain total torque required at any airspeed.

7.21 AIRCRAFT CONFIGURATION DRAG CHANGES FOR USE WITH CLEAN CRUISE CHARTS.

When external equipment or configuration differs from the baseline clean configuration as defined in Section I, a drag correction should be made similarly to the external drag load method. Typical configuration changes that have drag areas established from flight test or analysis along with their drag multiplying factor are shown on Table 7-1.

Table 7-1. Configuration Drag Change

DRAG CHANGES FOR USE WITH CLEAN CRUISE CHARTS		
Item	Change in Flat Plate Drag Area- ΔF Sq. Ft.	Drag Multiplying Factor
a. Both cargo doors open	6.0	0.60
b. Cargo doors removed	4.0	0.40
c. Cargo mirror installed	0.3	0.03
d. IR Countermeasure Transmitter (ALQ-144) installed	0.8	0.08
e. Chaff Dispenser Installed	0.3	0.03
f. HIRSS not installed	-2.2	-0.22
g. Flare Dispenser EH	0.3	0.03
h. EH-60A Mission Antennas Only EH	3.8	0.38
i. Blade Erosion Kit	2.0	0.20
j. Skis installed	3.0	0.30

7.22 AIRCRAFT CONFIGURATION DRAG CHANGES FOR USE WITH HIGH DRAG CRUISE CHARTS.



When external equipment differs from the baseline high drag configuration as defined in this Section, a drag correction should be made using Figure 7-31 similar to the exter-

nal drag load method. Typical high drag configuration changes that have been established from flight test or analysis along with the drag multiplying factors are shown.

EXTERNAL DRAG LOAD

EXAMPLE

WANTED:
DRAG MULTIPLYING FACTOR
DUE TO EXTERNAL LOAD

KNOWN:
SHAPE OF EXTERNAL
LOAD = CYLINDER
FRONTAL AREA OF
EXTERNAL LOAD = 80 SQ FT

METHOD:
ENTER CHART AT SYMBOL
FOR CYLINDER
MOVE RIGHT TO 80 SQ FT.
MOVE DOWN AND READ
DRAG MULTIPLYING FACTOR
= 4.5

LOAD
DRAG

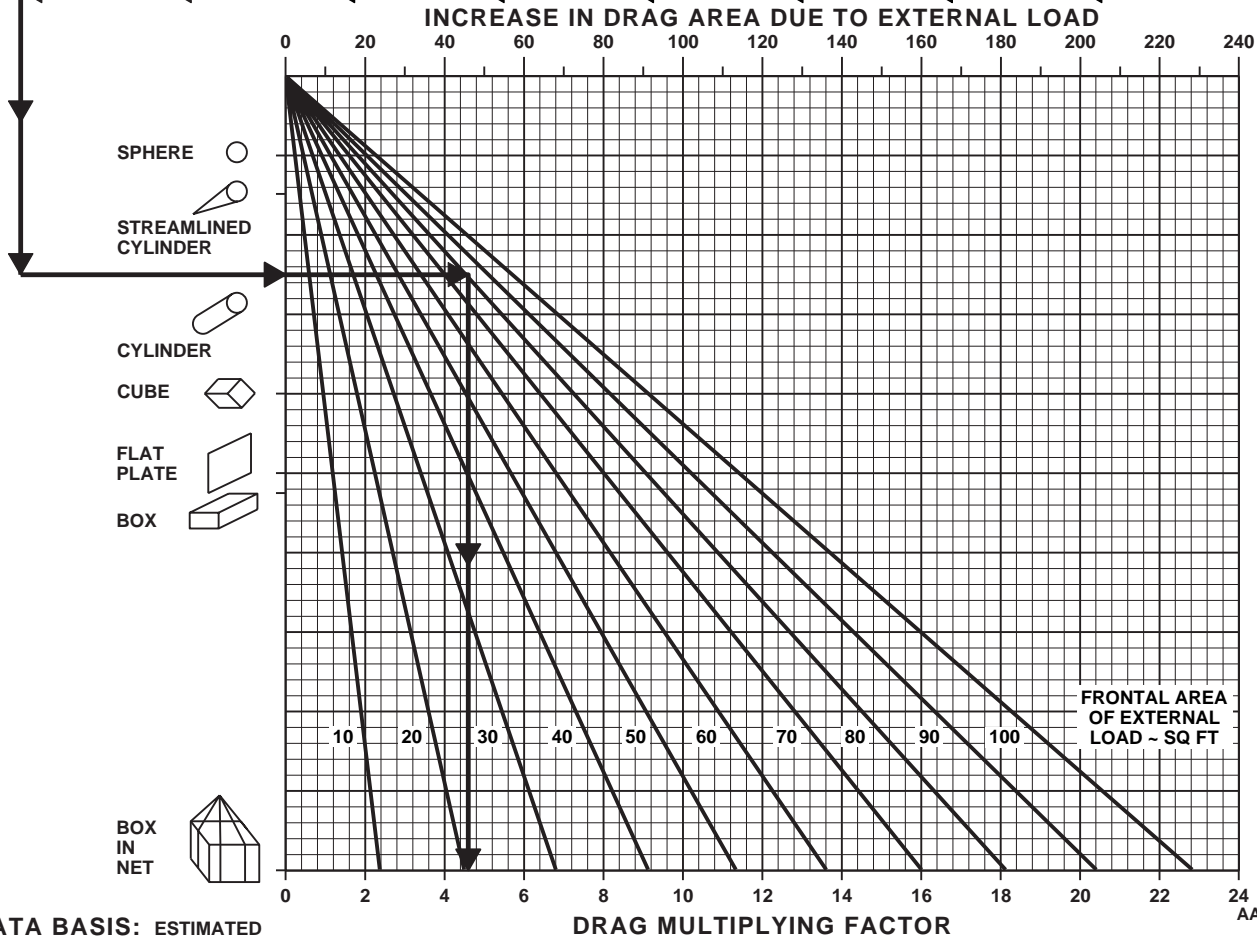

DATA BASIS: ESTIMATED

AA0684A
SA

Figure 7-30. External Load Drag

DRAG CONFIGURATIONS



	<p style="text-align: center;">HIGH DRAG CRUISE CHART BASELINE SPECIAL MISSION EQUIPMENT CONFIGURATIONS</p>	<p style="text-align: center;">CHANGE IN FLAT PLATE DRAG ΔF SQ FT</p>	<p style="text-align: center;">DRAG MULTI- PLYING FACTOR</p>
	<p style="text-align: center;">ESSS - CLEAN, PYLONS REMOVED</p>	-4.0	-0.40
	<p style="text-align: center;">ESSS - FOUR PYLONS / NO STORES</p>	-1.7	-0.17
	<p style="text-align: center;">ESSS-TWO 450-GALLON TANKS INBOARD -TWO 230-GALLON TANKS INBOARD</p>	0.5 0.0	0.05 0.00
	<p style="text-align: center;">ESSS-TWO 230-GALLON TANKS OUTBOARD -TWO 450-GALLON -TANKS INBOARD</p>	2.5	0.25
	<p style="text-align: center;">ESSS - FOUR 230-GALLON TANKS</p>	2.0	0.20
	<p style="text-align: center;">VOLCANO SYSTEM INSTALLED (BOTH RACKS) * VOLCANO CORRECTION MUST BE USED WITH HIGH DRAG CHARTS ONLY VOLCANO SYSTEM INSTALLED (LOWER RACKS ONLY)</p>	32.5 10.5	3.25 1.05
	<p style="text-align: center;">SKIS INSTALLED</p> <p style="text-align: center;">BOTH CARGO DOORS OPEN</p> <p style="text-align: center;">BOTH CARGO DOORS REMOVED</p> <p style="text-align: center;">CARGO MIRROR INSTALLED</p> <p style="text-align: center;">IR COUNTERMEASURE TRANSMITTER (ALQ-144) REMOVED</p> <p style="text-align: center;">CHAFF DISPENSER REMOVED</p>	3.0 6.0 4.0 0.3 -0.8 -0.3	0.30 0.60 0.40 0.03 -0.08 -0.03

AA0685B
SA

Figure 7-31. Typical High Drag Configurations

Section VII CLIMB - DESCENT

7.23 CLIMB/DESCENT CHART.

The CLIMB/DESCENT chart (Figures 7-32 and 7-33) presents the rate of climb or descent resulting from an increase or decrease of engine torque from the value required for level flight above 40 KIAS. The data are presented at 100% RPM R for various gross weights. The charts may also be used in reverse to obtain the torque increase or

reduction required to achieve a desired steady rate of climb or descent. The maximum R/C may be determined by subtracting the cruise chart torque required from the maximum torque available at the desired flight conditions. Then enter the difference on the torque increase scale of the climb chart, move up to the gross weight, and read the resulting maximum R/C.

CLIMB/DESCENT

CLEAN CONFIGURATION 100% RPM R FOR IAS ABOVE 40 KIAS

EXAMPLE

WANTED:
INDICATED TORQUE CHANGE FOR
DESIRED RATE-OF-CLIMB OR DESCENT.

KNOWN:
GROSS WEIGHT = 18,000 POUNDS
DESIRED RATE = 550 FEET PER MINUTE

METHOD:
ENTER CHART AT 550 FEET PER MINUTE
MOVE RIGHT TO INTERSECT GROSS
WEIGHT LINE. MOVE DOWN TO READ
12% TRQ CHANGE.

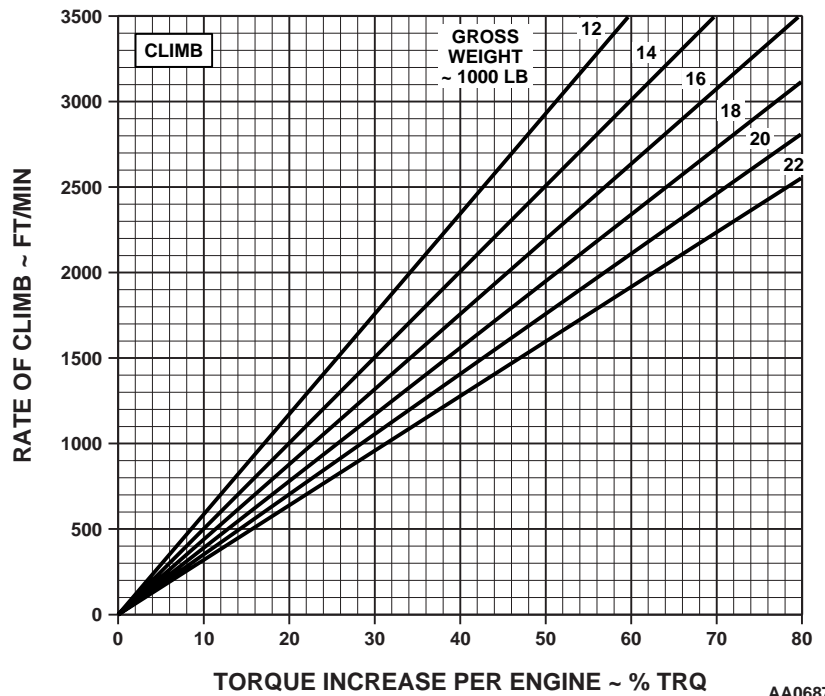
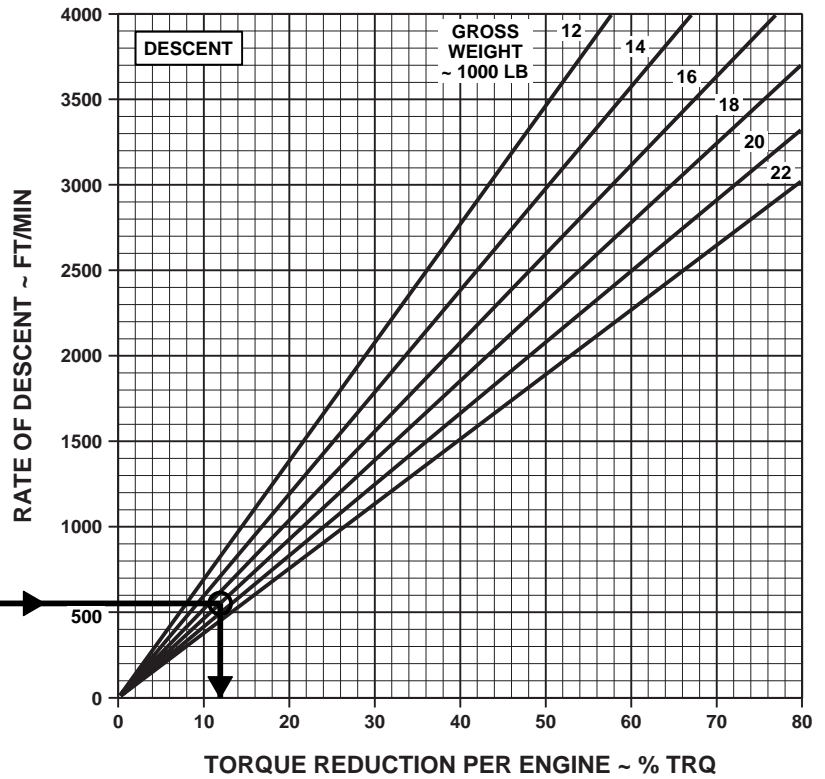

DATA BASIS: FLIGHT TEST

AA0687A
SA

Figure 7-32. Climb/Descent

CLIMB/DESCENT

100% RPM R

AIRSPEEDS ABOVE 40 KIAS

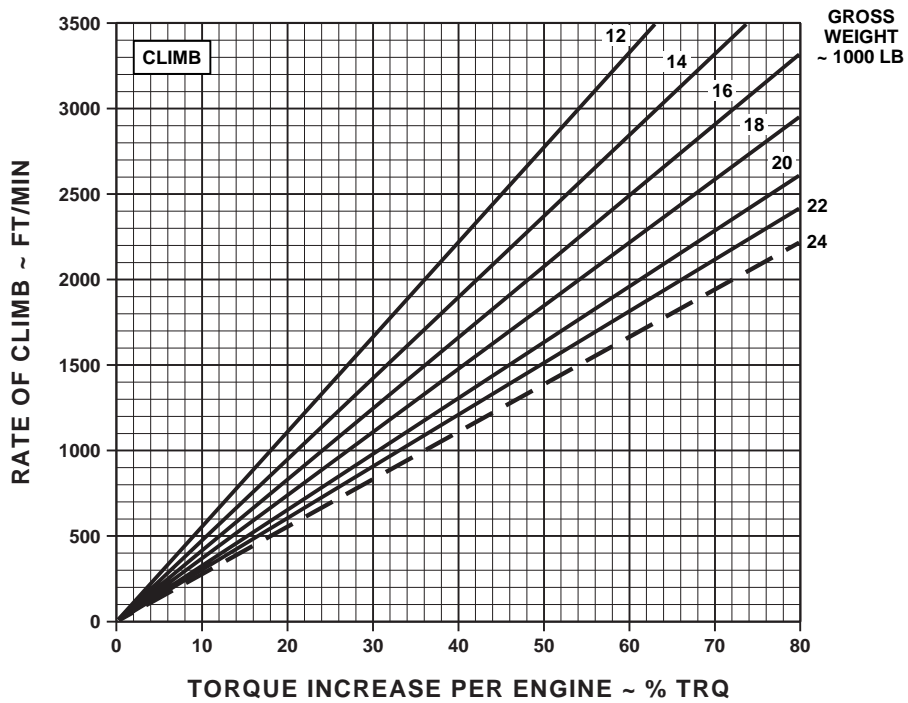
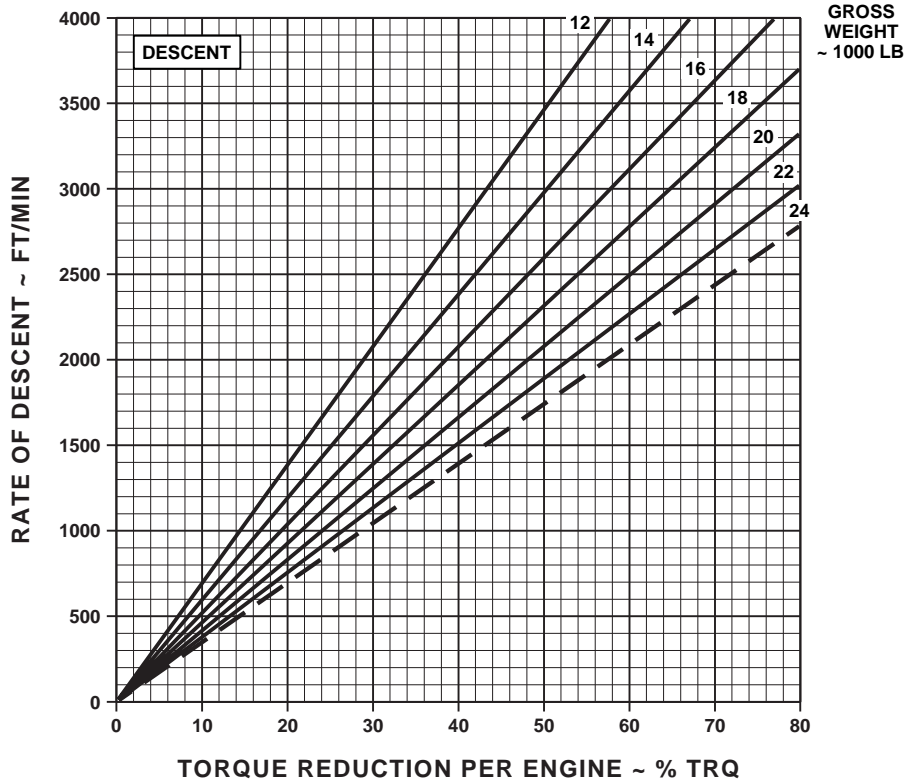

DATA BASIS: FLIGHT TEST

AA0688A
SA

Figure 7-33. Climb/Descent - High Drag

Section VIII FUEL FLOW

7.24 IDLE FUEL FLOW.

Dual-engine idle fuel flow is presented as a function of altitude at 0°C FAT in Table 7-2. The data are based on operation at 62% to 69% Ng for idle and 85% to 89% for flat pitch (collective full down) at 100% RPM R. Fuel flow for the auxiliary power unit (APU) is also presented for a nominal load of 80% maximum power as a function of altitude and 0°C FAT for general planning.

7.25 SINGLE-ENGINE FUEL FLOW.

a. Engine fuel flow is presented in Figure 7-34 for various torque and pressure altitudes at a baseline FAT of 0°C with engine bleed air extraction off. When operating at other than 0°C FAT, engine fuel flow is increased 1% for each 20°C above the baseline temperature and, decreased 1% for each 20°C below the baseline temperature.

b. To determine single-engine fuel flow during cruise, enter the fuel flow chart at double the torque required for dual-engine cruise as determined from the cruise charts and obtain fuel flow from the single-engine scale. The single-engine torque may not exceed the transmission limit shown on the chart. With bleed air on, single-engine fuel flow increases as follows:

(1) With bleed-air extracted, fuel flow increases:

- (a) Engine anti-ice on - About 30 lbs/hr
- (b) Heater on - About 10 lbs/hr

(c) Both on - About 40 lbs/hr

(2) When the IR suppressor system is installed and operating in the benign mode (exhaust baffles removed), the single-engine fuel flow will decrease about 8 lbs/hr.

7.26 DUAL-ENGINE FUEL FLOW.

Dual-engine fuel flow for level flight is presented on the cruise charts in Section IV. For other conditions dual-engine fuel flow may be obtained from Figure 7-34 when each engine is indicating approximately the same torque by averaging the indicated torques and reading fuel flow from the dual-engine fuel flow scale. When operating at other than the 0° FAT baseline, dual-engine fuel flow is increased 1% for each 20°C above baseline and is decreased 1% for each 20°C below baseline temperature. With bleed air on, dual-engine fuel flow increases as follows:

a. With bleed-air extracted, fuel flow increases:

- (1) Engine anti-ice on -About 60 lbs/hr

Example: (760 lbs/hour = 820 lbs/hr).

- (2) Heater on - About 20 lbs/hr
- (3) Both on - About 80 lbs/hr

b. When the cruise or hover IR suppressor system is installed and operating in the benign mode (exhaust baffles removed), the dual-engine fuel flow will decrease about 16 lbs/hr.

Table 7-2. Dual Engine Idle and Auxiliary Power Unit Fuel Flow

Pressure Altitude Feet	Ng = 62-69%		Ng = 85-89%	APU (Nominal) Lb/Hr
	Ground	Idle (No Load)	Flat Pitch (100% RPM R)	
	Lb/Hr		Lb/Hr	
0	350		580	120
4,000	326		500	105
8,000	268		440	90
12,000	234		380	75
16,000	206		320	65
20,000	182		270	55

SINGLE/DUAL-ENGINE FUEL FLOW

100% RPM R FAT = 0°C BLEED AIR OFF
HIRSS (BAFFLES INSTALLED)

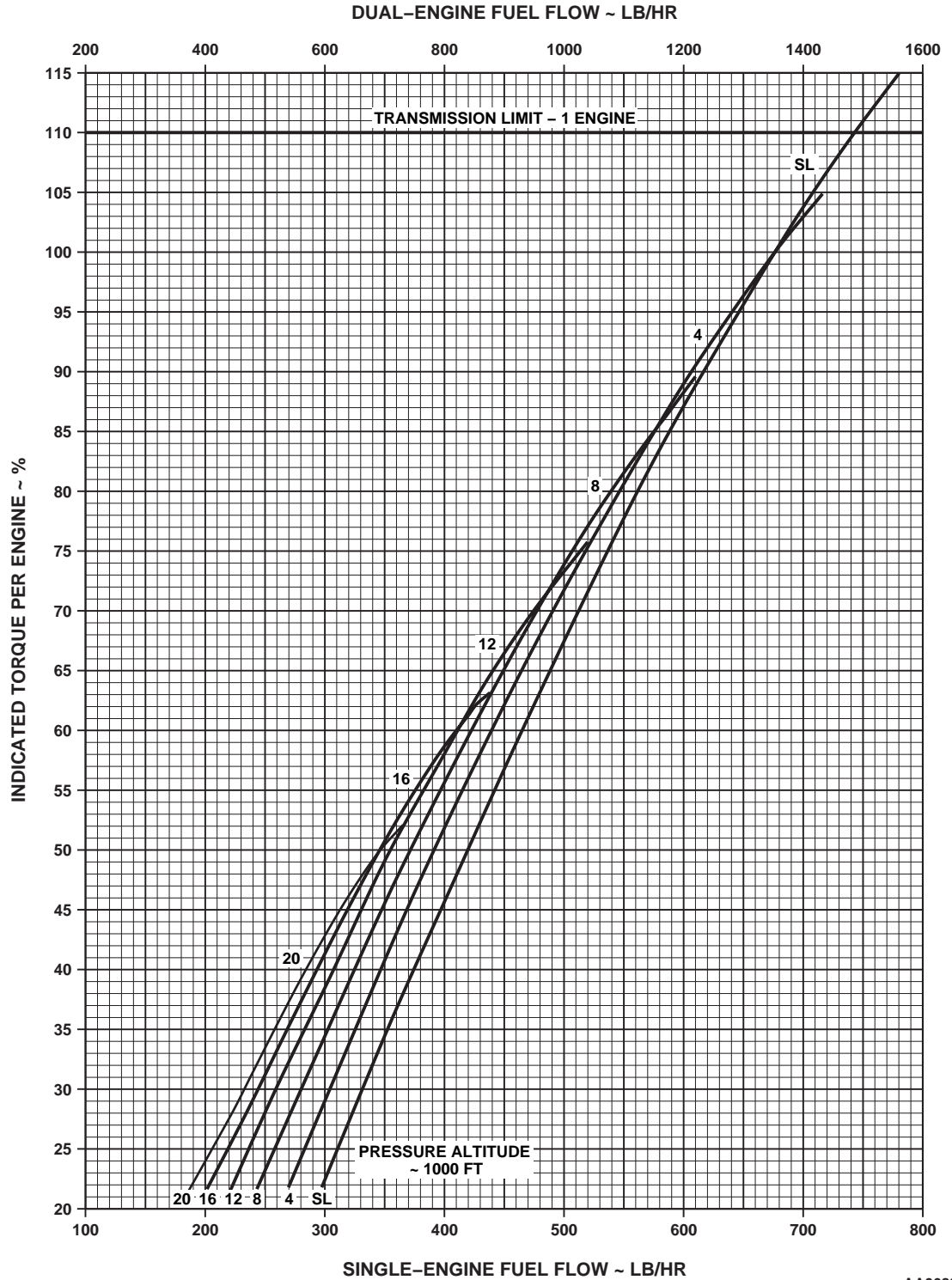

NOTE

INCREASE FUEL FLOW
1% FOR EACH 20 °C
ABOVE 0 °C FAT AND
DECREASE FUEL FLOW
1% FOR EACH 20 °C
BELOW 0 °C FAT.

AA0689
SA

Figure 7-34. Single/Dual-Engine Fuel Flow

Section IX AIRSPEED SYSTEM CHARACTERISTICS

7.27 AIRSPEED SYSTEM CHARACTERISTICS

NOTE

Indicated airspeeds below 40 KIAS are unreliable. Airspeed conversion data KIAS to KTAS for speeds above 40 KIAS are provided in Section IV CRUISE.

There are two different pitot-static systems on the UH-60A. The type of airspeed system may be determined from the mounting of the pitot-static probes on the cabin roof. The pitot-static probes were originally flush mounted, the modified pitot-static probes are mounted on a wedge which rotates the pitot tube 20° further outboard and 3° nose down. The wedge is covered by an aerodynamic fairing to prevent ice accretion. The modified airspeed system was used to derive the IAS presented on the charts in this manual.

7.28 AIRSPEED CHARTS.

7.28.1 Airspeed Correction Charts. All indicated airspeeds shown on the cruise charts are based on level flight of an aircraft with wedge mounted pitot static probes. Figures 7-35 through 7-37 provide the airspeed correction to be added to the cruise chart IAS values to determine the related airspeed indicator reading for other than level flight mode. There are small variations in airspeed system errors in level flight between those aircraft with wedge mounted pitot static probes and those without wedge mounted pitot static probes. Correction for these small variations is not normally warranted. There are relatively large variations in airspeed system error associated with climbs and descents.

These errors are significant and Figures 7-35 through 7-37 are provided primarily to show the general magnitude and direction of the errors associated with the various flight modes. If desired, these figures may be used in the manner shown by the examples to calculate specific airspeed corrections.

7.28.2 Airspeed System Dynamic Characteristics.

The dynamic characteristics of the pilot and copilot airspeed indicating systems are normally satisfactory. However, the following anomalies in the airspeed and IVSI indicating system may be observed during the following maneuvers or conditions:

- a. During takeoffs, in the speed range of 40 to 80 KIAS, 5 to 10 KIAS airspeed fluctuation may be observed on the pilot's and copilot's airspeed indicators.
- b. Power changes in high power, low airspeed climbs may cause as much as 30 knot airspeed changes in indicated airspeed. Increase in power causes increase in indicated airspeed, and a decrease in power causes decrease in indicated airspeed.
- c. The pilot and copilot airspeed indicators may be unreliable during high power climbs at low airspeeds (less than 50 KIAS) with the copilot system reading as much as 30 knots lower than the pilot system.
- d. On aircraft with wedge mounted pitot static probes kit, in-flight opening and closing of doors and windows may cause momentary fluctuations of approximately 300 feet per minute on the vertical speed indicators.

AIRSPEED SYSTEM CORRECTION CLEAN AIRCRAFT WITHOUT WEDGE MOUNTED PITOT-STATIC PROBES

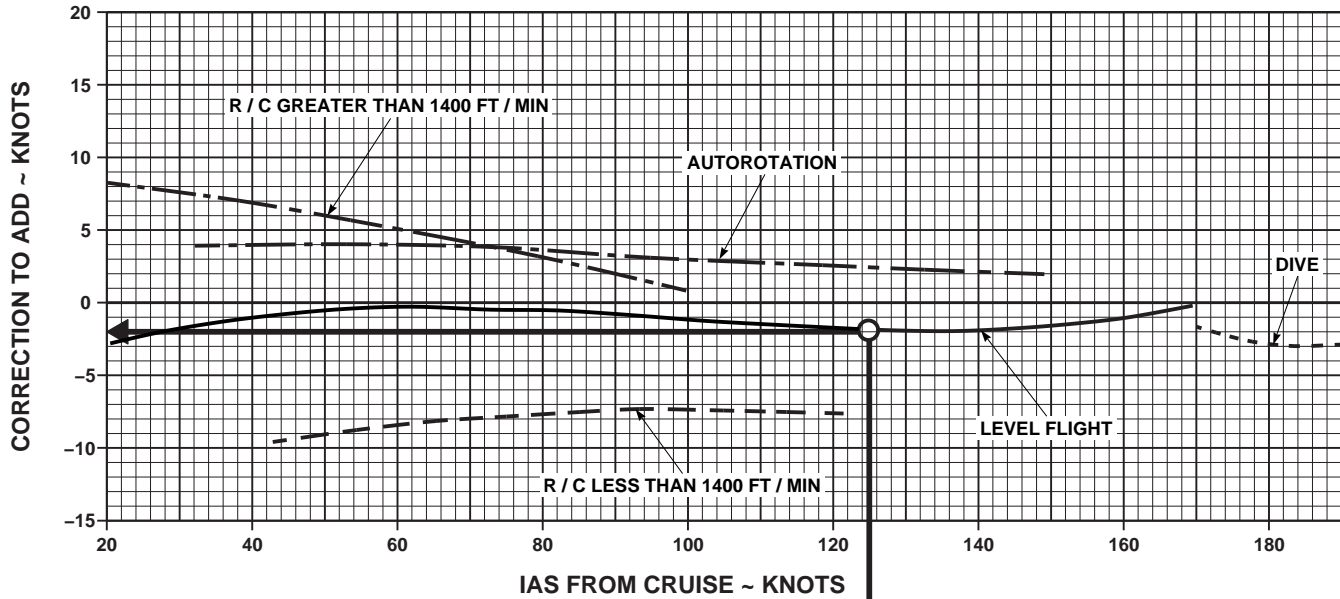

EXAMPLE

WANTED:

INDICATED AIRSPEED TO OBTAIN MAX RANGE FOR AN AIRCRAFT WITHOUT WEDGE MOUNTED PITOT-STATIC PROBES.

KNOWN:

125 KIAS FOR MAX RANGE CRUISE CHART AT A GIVEN PRESSURE ALTITUDE, FAT, AND GROSS WEIGHT.

METHOD:

ENTER AT KNOWN IAS FROM CRUISE CHART FOR MAX RANGE, MOVE UP TO LEVEL FLIGHT LINE, MOVE LEFT, READ CORRECTION TO ADD TO IAS = -2 KIAS. CALCULATE IAS FOR MAX RANGE:
= 125 KIAS - 2 KIAS = 123 KIAS.

DATA BASIS: FLIGHT TEST

AA0690C
SA

Figure 7-35. Airspeed Correction Aircraft Without Wedge Mounted Pitot-Static Probes

AIRSPEED SYSTEM CORRECTION CLEAN WITH WEDGE MOUNTED PITOT-STATIC PROBES

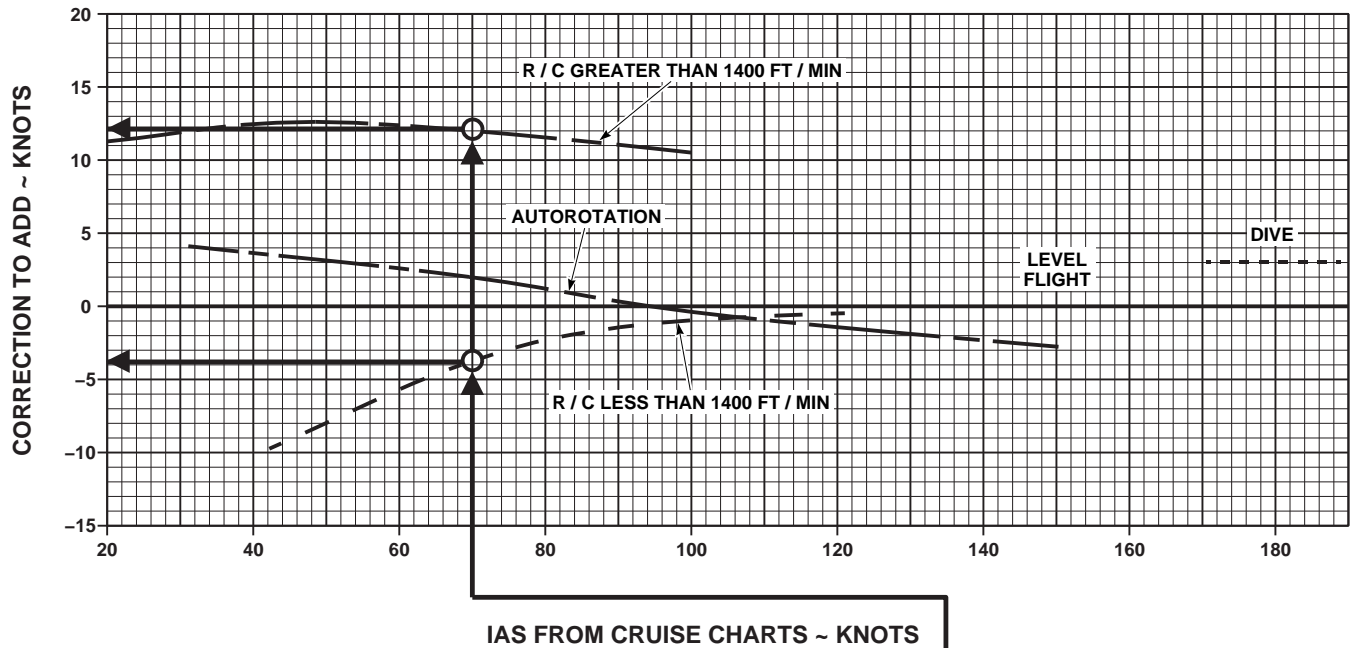

EXAMPLE

WANTED:

INDICATED AIRSPEED TO CLIMB AT MAXIMUM RATE OF CLIMB FOR AN AIRCRAFT WITH WEDGE MOUNTED PITOT-STATIC PROBES.

KNOWN:

70 KIAS MAX END / AND R / C FROM APPROPRIATE CRUISE CHART FOR A GIVEN PRESSURE ALTITUDE, FAT, AND GROSS WEIGHT.

METHOD:

ENTER AT KNOWN IAS FROM CRUISE CHART, MOVE UP TO R / C GREATER THAN 1400 FPM, MOVE LEFT READ CORRECTION TO ADD TO IAS = + 12.5 KTS, RE-ENTER AT KNOWN IAS FROM CRUISE CHART, MOVE UP TO R / C LESS THAN 1400 FPM LINE, MOVE LEFT, READ CORRECTION TO ADD TO IAS = - 4 KTS
CALCULATE IAS FOR MAX R / C WHEN:

FOR R / C GREATER THAN 1400 FPM, AIRSPEED = 70 KIAS + 12.5 KIAS = 82.5 KIAS

FOR R / C LESS THAN 1400 FPM, AIRSPEED = 70 KIAS - 4 KIAS = 66 KIAS

DATA BASIS: FLIGHT TEST

AA0691B
SA

Figure 7-36. Airspeed Correction Aircraft With Wedge Mounted Pitot-Static Probes

AIRSPEED SYSTEM CORRECTION

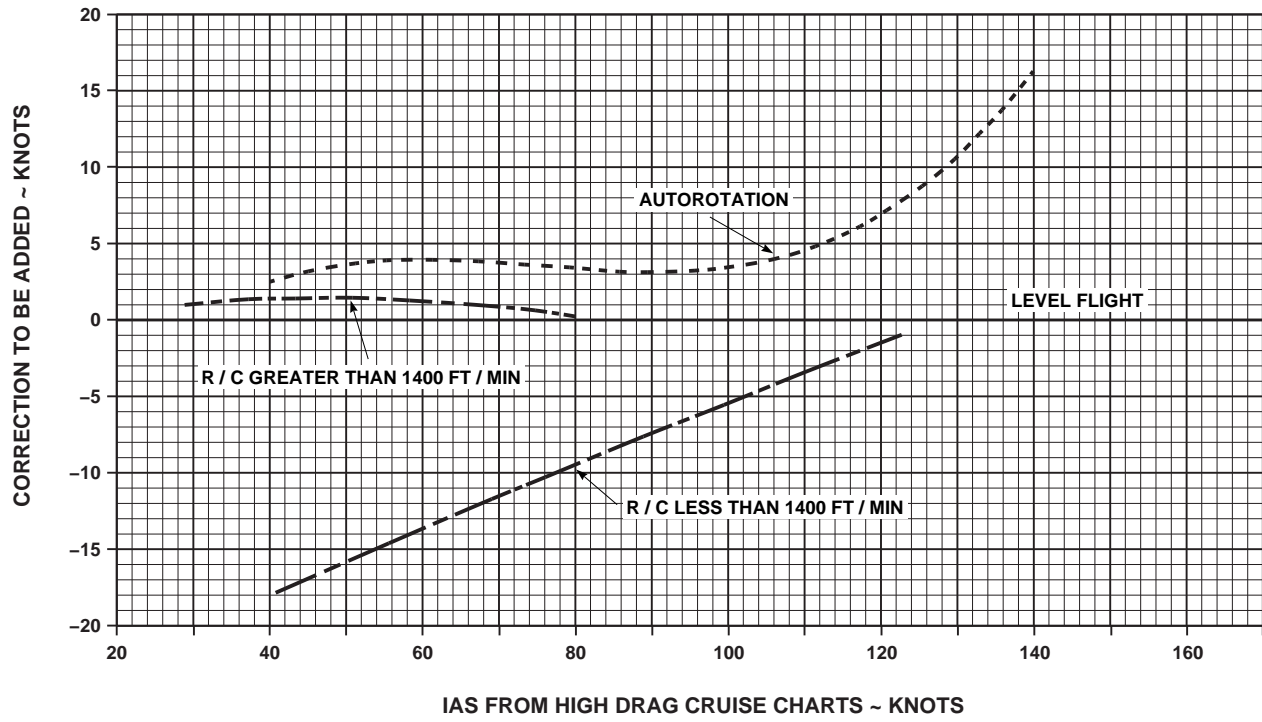

DATA BASIS: FLIGHT TEST

AA1029A
SA

Figure 7-37. Airspeed Correction Chart - High Drag

Section X SPECIAL MISSION PERFORMANCE

7.29 SPECIAL MISSION FLIGHT PROFILES.

Figures 7-38 through 7-40 show special mission flight profiles required to obtain near maximum range when equipped with the ESSS in three different tank configurations. The upper segment of each chart provides the recommended altitude profile along with the IAS and average TRQ versus distance traveled. An average value of elapsed time is also presented on the lower axis of the altitude scale. The lower segment of each chart provides the relationship between fuel remaining and distance traveled resulting from the flight profile shown. This portion may be utilized to check actual inflight range data to provide assurance that adequate range is being achieved. The chart is divided into 3 regions of Adequate Range, Inadequate range-return to base, and Inadequate range-requiring emergency action. When an inflight range point is in the Adequate range region, the required mission range can be obtained by staying on the recommended flight profile. However, the range may not be achieved if stronger headwinds are encountered as the flight progresses, and normal pilot judgement must be used. These charts also assume that the flight track is within proper navigational limits. Standard temperature variation with PA is shown on the upper segment of the charts. A general correction for temperature variation is to decrease IAS by 2.5 KTS and total distance traveled by 0.5% for each 10°C above standard. Detailed flight planning must always be made for the actual aircraft configuration, fuel load, and flight conditions when maximum range is required. This data is based on JP-4 fuel. It can be used with JP-5 or JP-8, aviation gasoline, or any other approved fuels **ONLY IF THE TAKEOFF GROSS WEIGHT AND THE FUEL LOAD WEIGHT MATCH THE DATA AT THE TOP OF THE CHART**. The Flight Time and the Distance Traveled data **SHOULD NOT** be used with any full tank configuration if the fuel density is not approximately 6.5 lb/gal (JP-4 fuel).

a. **SELF-DEPLOYMENT MISSION.** The self-deployment mission is shown in Figure 7-38 and the ESSS is configured with two 230-gallon tanks outboard and two 450-gallon tanks inboard. In this configuration, the aircraft holds in excess of 11,000 lb of JP4 fuel and has a take-off gross weight of 24,500 pounds in order to achieve the desired mission range of 1,150 Nm. This gross weight is allowed for ferry missions only, requiring low load factors

and less than 30 degree angle banked turns. This mission was calculated for a standard day with a constant 10 knot headwind added to be conservative. Since there may not be any emergency landing areas available, the mission should not be attempted if headwinds in excess of 10 knots are forecast. Take-off must be made with a minimum of fuel used (60 pounds) for engine start and warm-up, and a climb to 2,000 feet should be made with maximum power and airspeed between 80 and 105 KIAS. The first segment should be maintained at 2,000 feet and 105 KIAS for 2 hours. The average engine TRQ should be about 79% for this segment, but will initially be a little more and gradually decrease. Altitude is increased in 2,000 foot increments to maintain the optimum altitude for maximum range to account for fuel burn. The first 2 segments are for 2 hours each, followed by 1 hour segments until reaching 10,000 feet. At this altitude, the airspeed for best range should also be reduced to 95 KIAS for the remainder of the flight. Engine bleed air was assumed to be off for this mission except for that required for fuel tank pressurization. Electrical cabin heat may be used. Removal of the HIRSS baffles (benign mode) will reduce fuel flow by about 16 lbs/hr. If oxygen is available, continuation of the staircase climb sequence to 15,500 feet PA will result in about 23 additional Nm of range capability.

b. **ASSAULT MISSION PROFILE - 4 tanks.** The assault mission profile is shown in Figure 7-39 with the ESSS configured with four 230-gallon tanks. In this configuration, the aircraft holds in excess of 8,300 pounds of JP4 fuel and assumes a take-off gross weight of 22,000 pounds which provides a maximum mission range of 1140 Nm with 400 lbs reserve. This mission was calculated for a standard day with a zero headwind. Take-off must be made with a minimum of fuel used (80 pounds) for engine start and warm-up, and a Climb to 4,000 feet should be made with maximum power and airspeed between 80 and 108 KIAS. The first segment should be maintained at 4,000 feet and 108 KIAS for 1 hour. The average engine TRQ should be about 79% for this segment, but will initially be a little more and gradually decrease. Altitude is increased in 2,000 foot increments to maintain the optimum altitude for maximum range to account for fuel burn. The segments are for 1 hour each, until reaching 10,000 feet. At this altitude, the airspeed for best range should be reduced to 95 KIAS for the remainder of the flight.

c. ASSAULT MISSION PROFILE - 2 tanks. The assault mission profile is shown in Figure 7-40 with the ESSS configured with two 230-gallon tanks. In this configuration, the aircraft holds in excess of 5,300 pounds of JP4 fuel and assumes a take-off gross weight of 22,000 pounds which provides a maximum mission range of 630 Nm. with 400 lb reserve. This mission was calculated for a standard day with a zero headwind. Take-off must be made with a minimum of fuel used (80 lbs) for engine start and warm-up,

and a Climb to 4,000 feet should be made with max power and airspeed between 80 and 108 KIAS. The first segment should be maintained at 4,000 feet and 108 KIAS for 1 hour. The average engine TRQ should be about 77% for this segment, but will initially be a little more and gradually decrease as shown on each segment. Altitude is increased in 2,000 feet increments to maintain the optimum altitude for maximum range to account for fuel burn. At this altitude, the airspeed for best range should also be reduced to 95 KIAS for the remainder of the flight.

EXAMPLE:

WANTED:

Assurance of adequate aircraft range for mission defined.

KNOWN:

Flight position: 300 nm from base
Flight Track Within Limits
Fuel Remaining = 7,800 pounds
Elapsed flight time = 2 HRS, 50 MINS (2.83 HRS)
Target: Normal Flight Conditions:
 Airspeed = 105 KIAS
 Press Alt = 4,000 feet
 Approx Torque = 75%

METHOD:

- (1) Enter chart at total distance flown and at fuel remaining, move to intersection and plot point. If point falls on or above fuel remaining line (adequate range), remaining fuel is adequate to complete the mission. If point falls below the fuel remaining line in the inadequate range, abort mission region, immediately return to departure point while continuing to utilize altitude profile using total elapsed flight time (see item 2). If point falls below the fuel remaining line in the inadequate range, region, consult emergency procedures for corrective action.
- (2) To determine target nominal flight conditions, enter upper chart at elapsed flight time and move up to determine target airspeed, approximate torque, and pressure altitude.

Figure 7-38. Self Deployment Mission Profile (Sheet 1 of 2)

SELF DEPLOYMENT MISSION PROFILE
ESSS/2-230 AND 2-450 GALLON TANK CONFIGURATION
STANDARD DAY 10 KT HEADWIND
HIRSS SUPPRESSED MODE
GROSS WEIGHT = 24,500 LB FUEL LOAD = 11,000 LB (JP4)
BLEED AIR OFF 60 LB WARM UP

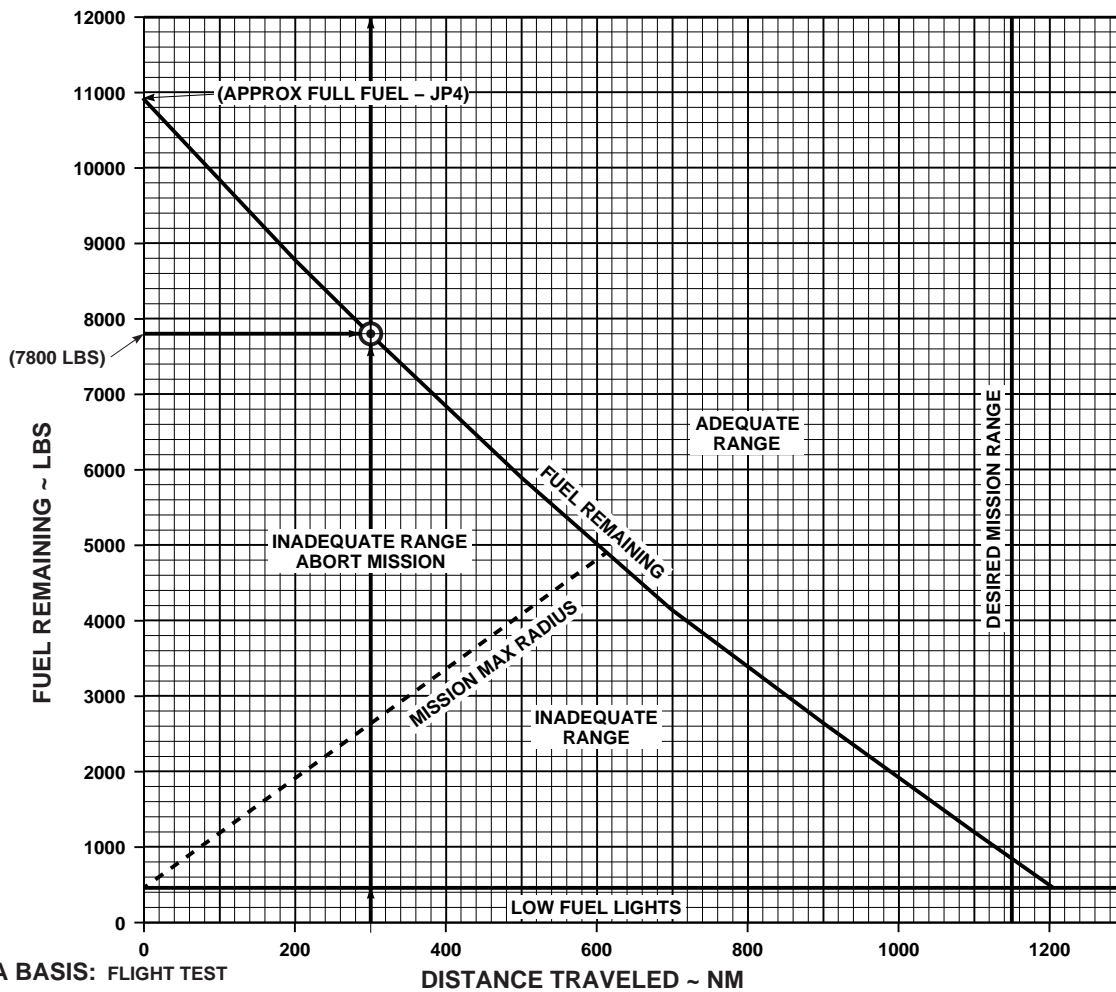
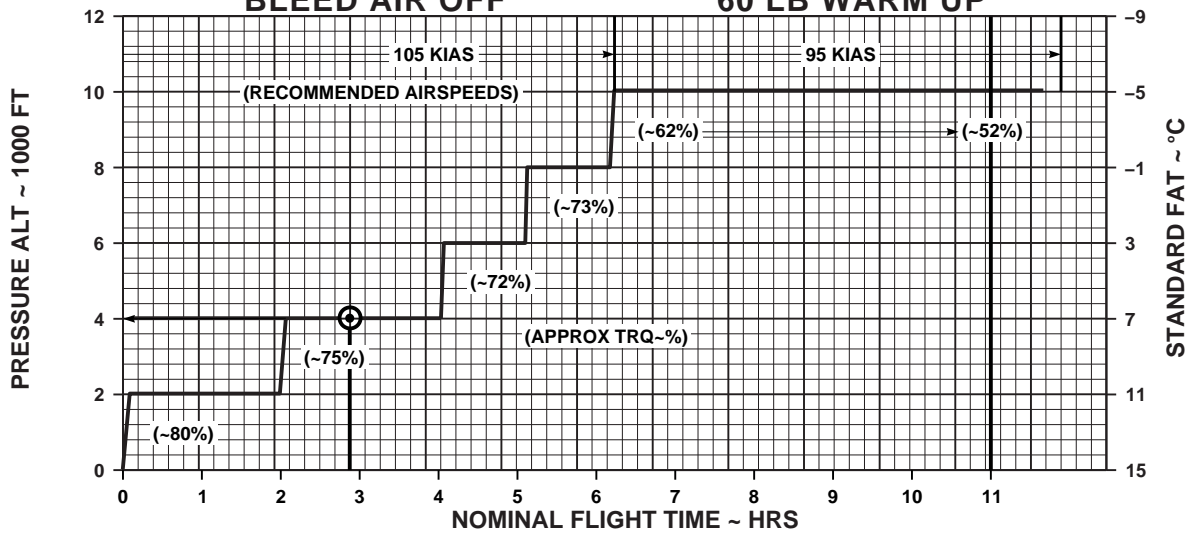

DATA BASIS: FLIGHT TEST

DISTANCE TRAVELED ~ NM

AA0608_2B
SA

Figure 7-38. Self Deployment Mission Profile (Sheet 2 of 2)

ASSAULT MISSION PROFILE FOR MAX RANGE
ESSS/4-230 GALLON TANK CONFIGURATION
STANDARD DAY ZERO HEADWIND
HIRSS SUPPRESSED MODE
GROSS WEIGHT = 22,000 LB FUEL LOAD = 8,300 LB (JP4)
BLEED AIR OFF 80 LB WARM UP

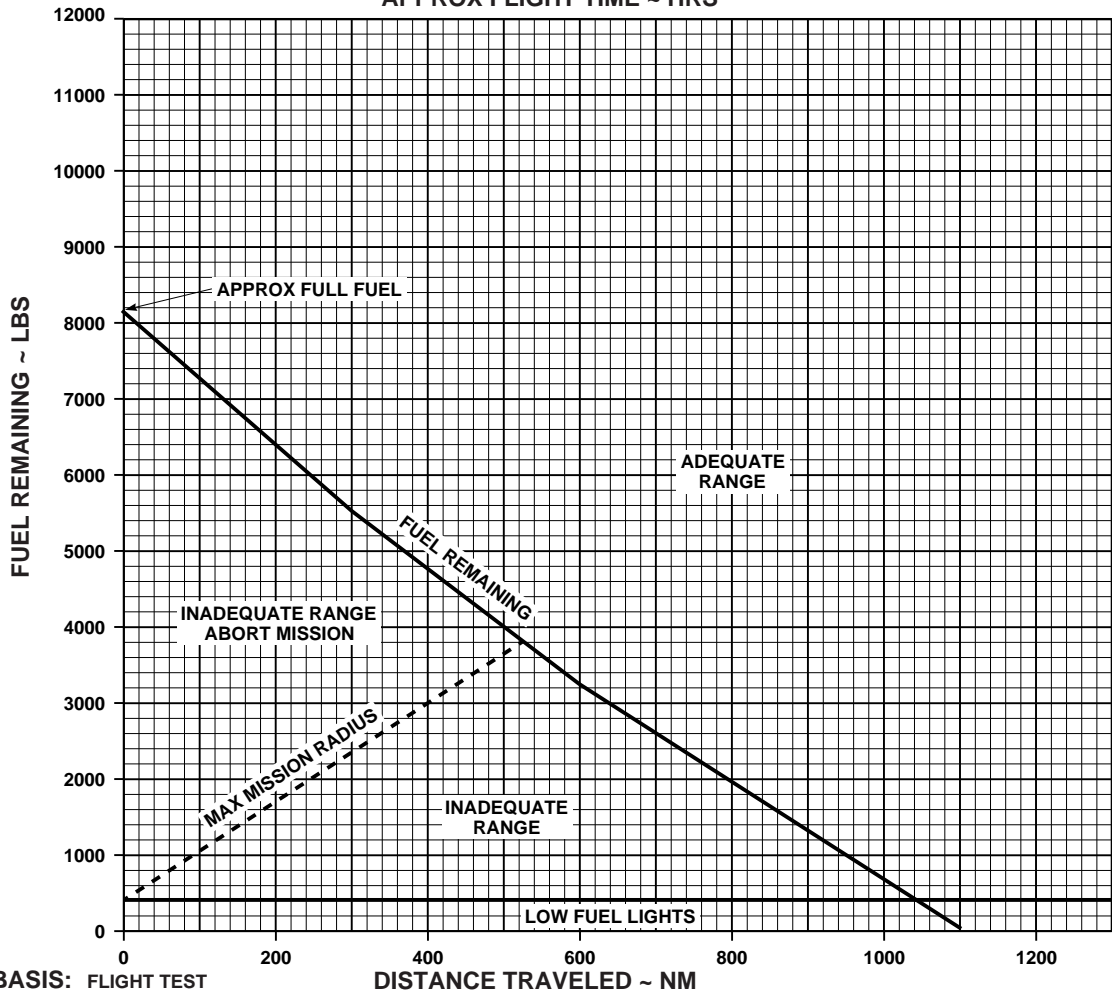
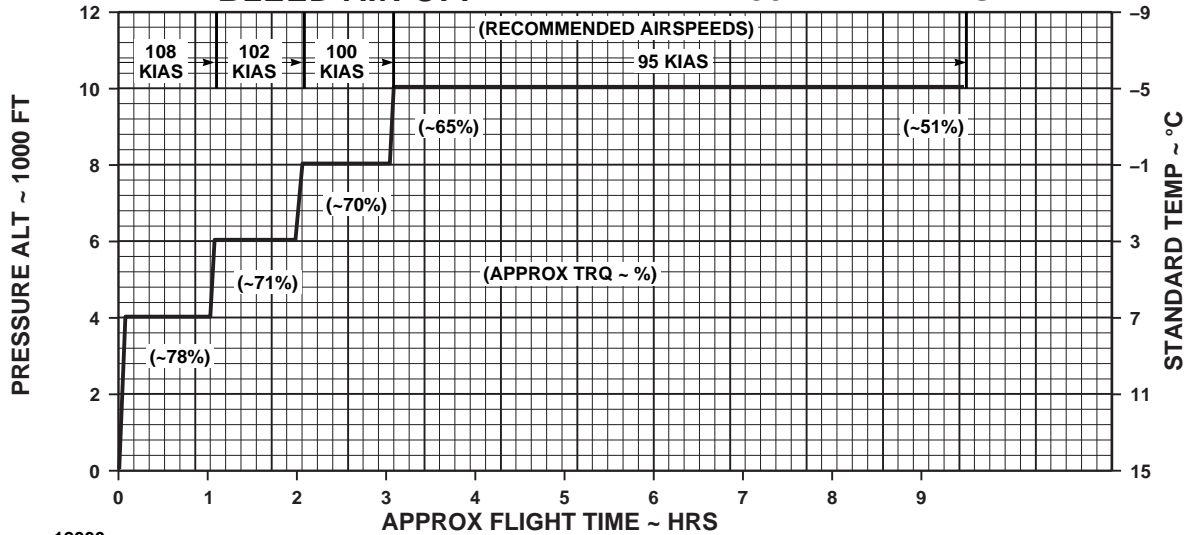

DATA BASIS: FLIGHT TEST

DISTANCE TRAVELED ~ NM

AA0610A
SA

Figure 7-39. Assault Mission Profile (4 - 230 Gallon Tanks)

ASSAULT MISSION PROFILE FOR MAX RANGE
ESSS/2-230 GALLON TANK CONFIGURATION
STANDARD DAY ZERO HEADWIND
HIRSS SUPPRESSED MODE
GROSS WEIGHT = 22,000 LB FUEL LOAD = 5,300 LB (JP4)
BLEED AIR OFF 80 LB WARM UP

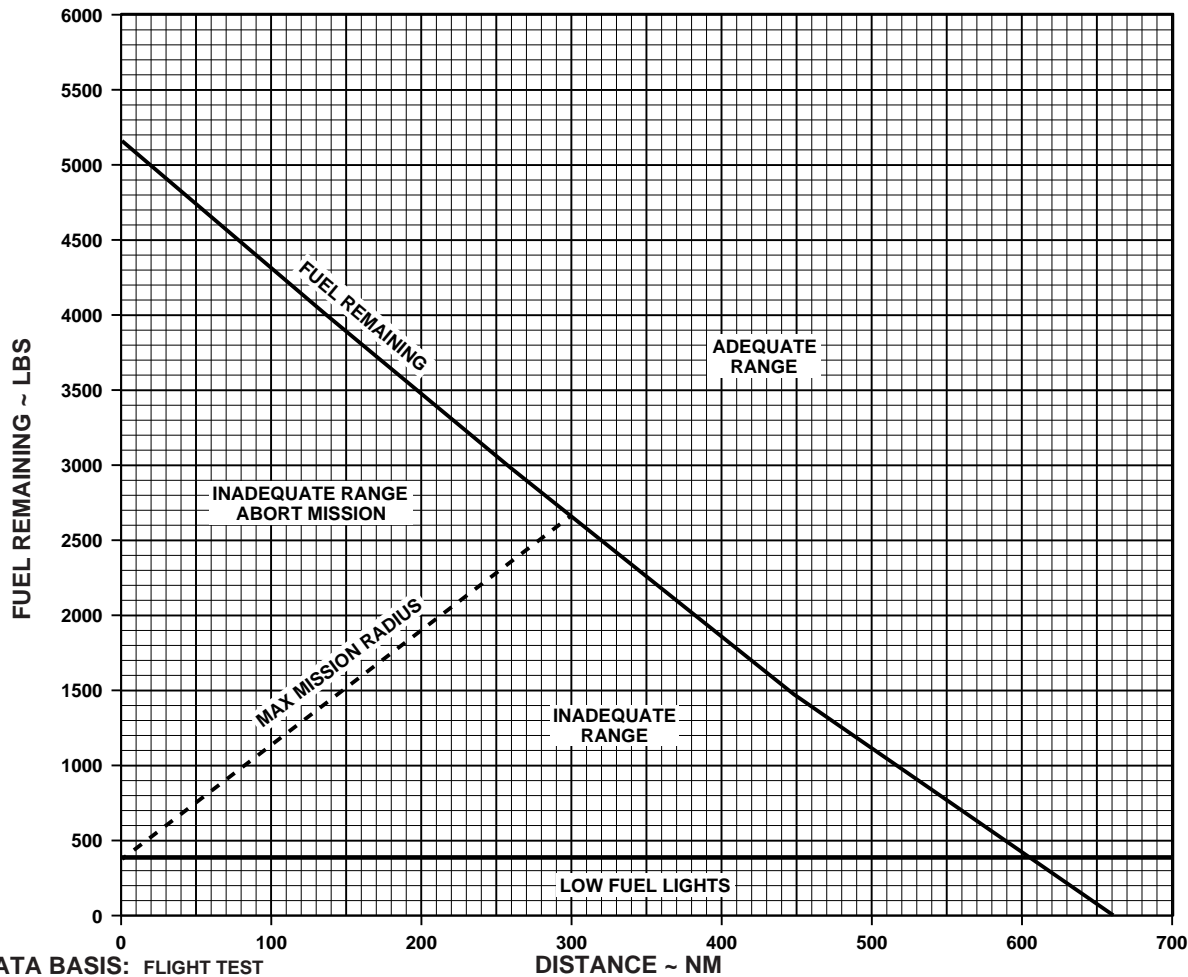
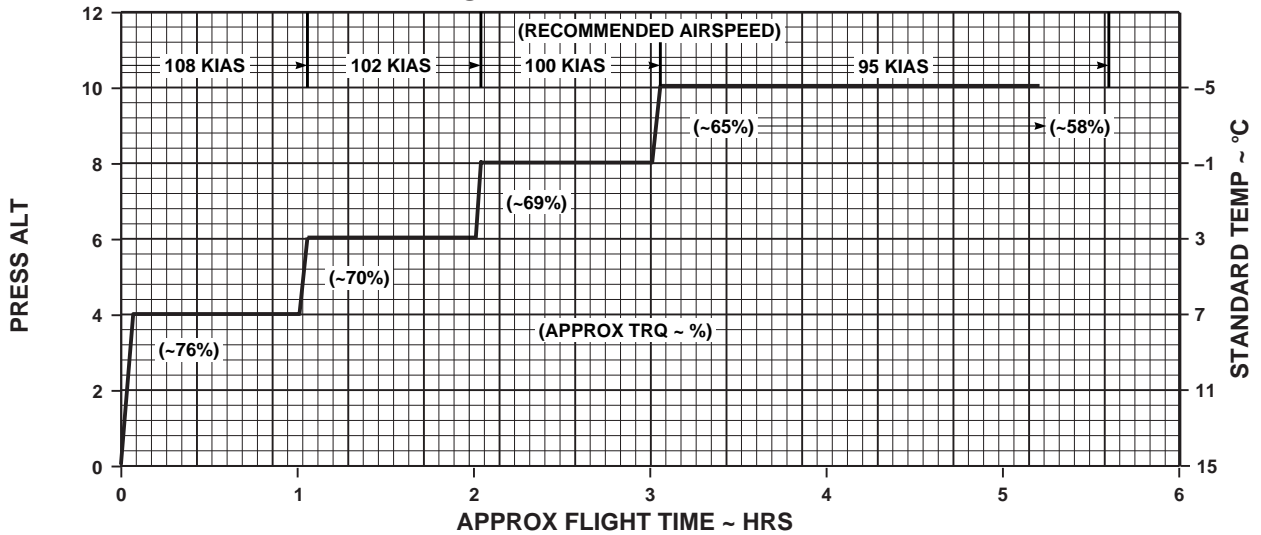

Figure 7-40. Assault Mission Profile (2 - 230 Gallon Tanks)

CHAPTER 7A

PERFORMANCE DATA 701C

Section I INTRODUCTION

7A.1 PURPOSE.

NOTE

Chapter 7A contains performance data for aircraft equipped with T700-GE-701C engines. Performance data for other models are contained in Chapter 7. Users are authorized to remove whichever chapter is not applicable to their model aircraft, and are not required to carry both chapters on board.

a. The purpose of this chapter is to provide the best available performance data for the UH-60L. Regular use of this information will enable you to receive maximum safe utilization of the helicopter. Although maximum performance is not always required, regular use of this chapter is recommended for these reasons:

(1) Knowledge of your performance margin will allow you to make better decisions when unexpected conditions or alternate missions are encountered.

(2) Situations requiring maximum performance will be more readily recognized.

(3) Familiarity with the data will allow performance to be computed more easily and quickly.

(4) Experience will be gained in accurately estimating the effects of variables for which data are not presented.

b. The information is primarily intended for mission planning and is most useful when planning operations in unfamiliar areas or at extreme conditions. The data may also be used in flight, to establish unit or area standard operating procedures, and to inform ground commanders of performance/risk tradeoffs.

7A.2 CHAPTER 7A INDEX.

The following index contains a list of the sections, titles, figure numbers, subjects and page numbers of each performance data chart contained in this chapter.

Section and Figure Number	Title	Page
I	INTRODUCTION	7A-1
7A-1	Temperature Conversion Chart.....	7A-5
II	MAXIMUM TORQUE AVAILABLE.....	7A-6
7A-2	Aircraft Torque Factor (ATF)	7A-7
7A-3	Torque Conversion Chart.....	7A-9
7A-4	Maximum Torque Available	7A-10
7A-5	Dual Engine Torque Limit.....	7A-12
III	HOVER.....	7A-13
7A-6	Hover - Clean	7A-14
7A-7	Hover - High Drag	7A-16
IV	CRUISE	7A-17
7A-8	Sample Cruise Chart.....	7A-19
7A-9	Cruise - Pressure Altitude - Sea Level	7A-20
7A-10	Cruise High Drag-Pressure Altitude - Sea Level	7A-26
7A-11	Cruise - Pressure Altitude - 2,000 Feet	7A-32
7A-12	Cruise High Drag-Pressure Altitude - 2,000 Feet	7A-38
7A-13	Cruise - Pressure Altitude - 4,000 Feet	7A-44
7A-14	Cruise High Drag-Pressure Altitude - 4,000 Feet	7A-50

Section and Figure Number	Title	Page
7A-15	Cruise - Pressure Altitude - 6,000 Feet	7A-56
7A-16	Cruise High Drag-Pressure Altitude - 6,000 Feet	7A-62
7A-17	Cruise - Pressure Altitude - 8,000 Feet	7A-68
7A-18	Cruise High Drag-Pressure Altitude - 8,000 Feet	7A-74
7A-19	Cruise - Pressure Altitude - 10,000 Feet	7A-80
7A-20	Cruise High Drag-Pressure Altitude - 10,000 Feet	7A-85
7A-21	Cruise - Pressure Altitude - 12,000 Feet	7A-90
7A-22	Cruise High Drag-Pressure Altitude - 12,000 Feet	7A-95
7A-23	Cruise - Pressure Altitude - 14,000 Feet	7A-100
7A-24	Cruise High Drag-Pressure Altitude - 14,000 Feet	7A-105
7A-25	Cruise - Pressure Altitude - 16,000 Feet	7A-110
7A-26	Cruise High Drag-Pressure Altitude - 16,000 Feet	7A-114
7A-27	Cruise - Pressure Altitude - 18,000 Feet	7A-118
7A-28	Cruise High Drag-Pressure Altitude - 18,000 Feet	7A-122
7A-29	Cruise - Pressure Altitude - 20,000 Feet	7A-126
7A-30	Cruise High Drag-Pressure Altitude - 20,000 Feet	7A-130
V	OPTIMUM CRUISE	7A-134
7A-31	Optimum Altitude For Maximum Range	7A-135
7A-32	Optimum Altitude For Maximum Range - High Drag	7A-136
VI	DRAG	7A-137

Section and Figure Number	Title	Page
7A-33	External Load Drag	7A-138
7A-34	Typical High Drag Configurations	7A-139
VII	CLIMB - DESCENT	7A-140
7A-35	Climb/Descent.....	7A-141
7A-36	Climb/Descent - High Drag	7A-142
VIII	FUEL FLOW	7A-143
7A-37	Single/Dual Engine Fuel Flow.....	7A-144
IX	AIRSPEED SYSTEM CHARACTERISTICS	7A-145
7A-38	Airspeed Correction Chart	7A-146
7A-39	Airspeed Correction Chart -High Drag.....	7A-147
X	SPECIAL MISSION PERFORMANCE.....	7A-148
7A-40	Self Deployment Mission Profile.....	7A-150
7A-41	Assault Mission Profile (4 - 230 Gallon Tanks).....	7A-152
7A-42	Assault Mission Profile (2 - 230 Gallon Tanks).....	7A-153

7.3 GENERAL.

The data presented covers the maximum range of conditions and performance that can reasonably be expected. In each area of performance, the effects of altitude, temperature, gross weight, and other parameters relating to that phase of flight are presented. In addition to the presented data, your judgment and experience will be necessary to accurately obtain performance under a given set of circumstances. The conditions for the data are listed under the title of each chart. The effects of different conditions are discussed in the text accompanying each phase of performance. Where practical, data are presented at conservative conditions. However, NO GENERAL CONSERVATISM HAS BEEN APPLIED. All performance data presented are within the applicable limits of the helicopter. All flight per

formance data are based on JP-4 fuel. The change in fuel flow and torque available, when using JP-5 or JP-8 aviation fuel or any other approved fuels is insignificant.

7.4 LIMITS.



Exceeding operating limits can cause permanent damage to critical components. Overlimit operation can decrease performance, cause early failure, or failure on a subsequent flight.

Applicable limits are shown on the charts. Performance generally deteriorates rapidly beyond limits. If limits are exceeded, minimize the amount and time. Enter the maximum value and time above limits on DA Form 2408-13-1 so proper maintenance action can be taken.

7.5 USE OF CHARTS.

7A.5.1 Data Basis. The type of data used is indicated at the bottom of each performance chart under DATA BASIS. The data provided generally is based on one of three categories:

- a. Flight test data. Data obtained by flight test of the helicopter by experienced flight test personnel at precise conditions using sensitive calibrated instruments.
- b. Calculated data. Data based on tests, but not on flight test of the complete helicopter.
- c. Estimated data. Data based on estimates using aerodynamic theory or other means but not verified by flight test.

7A.5.2 Specific Conditions. The data presented is accurate only for specific conditions listed under the title of each chart. Variables for which data is not presented, but which may affect that phase of performance, are discussed in the text. Where data is available or reasonable estimates can be made, the amount that each variable affects performance will be given.

7A.6 PERFORMANCE DISCREPANCIES.

Regular use of this chapter will allow you to monitor instrument and other helicopter systems for malfunction, by comparing actual performance with planned performance. Knowledge will also be gained concerning the effects of variables for which data is not provided, thereby increasing the accuracy of performance predictions.

7A.7 PERFORMANCE DATA BASIS - CLEAN.

The data presented in the performance charts are primarily derived for a clean UH-60L aircraft and are based on U. S. Army test data. The clean configuration assumes all doors and windows are closed and includes the following external configuration:

- a. Fixed provisions for the External Stores Support System (ESSS).
- b. Main and tail rotor deice system.
- c. Mounting brackets for IR jammer and chaff dispenser.
- d. The Hover Infrared Suppressor System (HIRSS) with baffles installed.
- e. Includes wire strike protection system.

NOTE

Aircraft which have an external configuration which differs from the clean configuration may be corrected for drag differences on cruise performance as discussed in Section VI DRAG.

7A.8 PERFORMANCE DATA BASIS - HIGH DRAG.

The data presented in the high drag performance charts are primarily derived for the UH-60L with the ESSS system installed and two 230-gallon tanks mounted on the outboard pylons, and are based on U. S. Army test data. The high drag configuration assumes all doors and windows are closed and includes the following external configuration:

- a. External stores support system installed.
- b. Two 230-gallon tanks mounted on the outboard pylons.
- c. Inboard vertical pylons empty.
- d. IR jammer and chaff dispenser installed.
- e. Hover Infrared Suppressor System (HIRSS) with baffles are installed.
- f. Main and tail rotor deice and wire strike protection systems are installed.

NOTE

Aircraft with an external configuration that differs from the high drag configuration baseline may be corrected for differences in cruise performance as discussed in Section VI DRAG.

g. **VOL** Use the high drag configuration hover charts to determine hover performance with the volcano system installed. Use the high drag cruise charts and the volcano drag correction factor to determine cruise performance with volcano installed. The volcano drag correction factor is

based on flight test data obtained with the complete volcano system installed, to include all of the canisters and mines. The drag correction factor may be used to provide a conservative estimate of cruise performance for volcano configurations which do not include all of the canisters and mines.

7A.9 FREE AIR TEMPERATURES.

A temperature conversion chart (Figure 7A-1) is included for the purpose of converting Fahrenheit temperature to Celsius.

TEMPERATURE CONVERSION

EXAMPLE

WANTED:

FREE AIR TEMPERATURE IN DEGREES CELSIUS

KNOWN:

FREE AIR TEMPERATURE = 32°F

METHOD:

ENTER FREE AIR TEMPERATURE HERE
 MOVE RIGHT TO DIAGONAL LINE
 MOVE DOWN TO DEGREES CELSIUS SCALE
 READ FREE AIR TEMPERATURE = 0°C

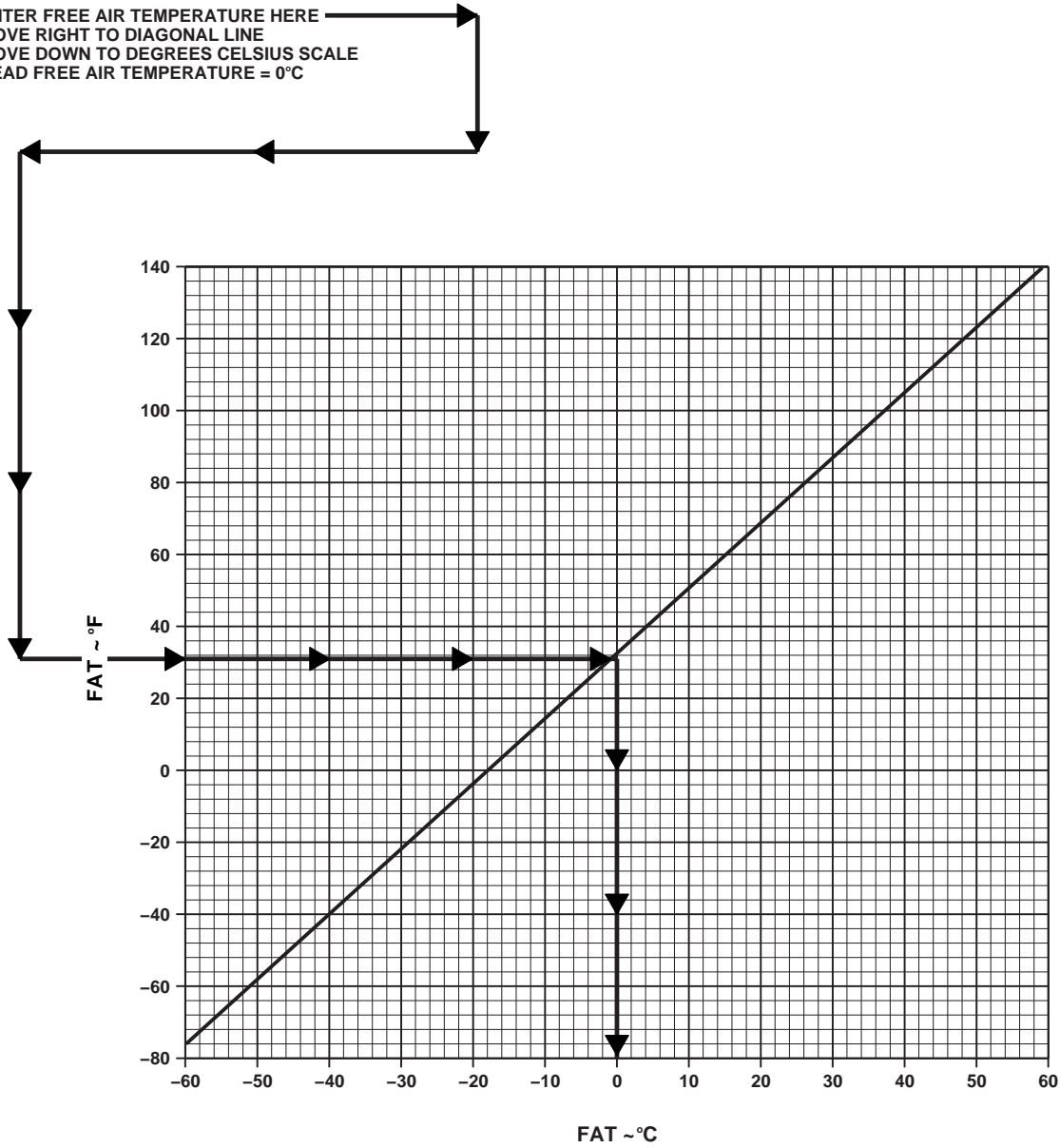

AA0674
SA

Figure 7A-1. Temperature Conversion Chart

Section II MAXIMUM TORQUE AVAILABLE

7A.10 TORQUE FACTOR METHOD.

The torque factor method provides an accurate indication of available power by incorporating ambient temperature effects on degraded engine performance. This section presents the procedure to determine the maximum dual- or single-engine torque available. Specification power is defined for a newly delivered low time engine. The aircraft HIT log forms for each engine provide the engine and aircraft torque factors which are obtained from the maximum power check and recorded to be used in calculating maximum torque available.

7A.10.1 Torque Factor Terms. The following terms are used when determining the maximum torque available for an individual aircraft:

a. Torque Ratio (TR). The ratio of torque available to specification torque at the desired ambient temperature.

b. Engine Torque Factor (ETF). The ratio of an individual engine torque available to specification torque at reference temperature of 35°C (95°F). The ETF is allowed to range from .85 to 1.0.

c. Aircraft Torque Factor (ATF). The ratio of an individual aircraft's power available to specification power at a reference temperature of 35°C (95°F). The ATF is the average of the ETF's of both engines and its value is allowed to range from 0.9 to 1.0.

7A.10.2 Torque Factor Procedure. The use of the ATF or ETF to obtain the TR from Figure 7A-2 for ambient temperatures between -15°C (5°F) and 35°C (95°F) is shown by the example. The ATF and ETF values for an individual aircraft are found on the engine HIT Log. The TR always equals 1.0 for ambient temperatures of -15°C (5°F) and below, and the TR equals the ATF or ETF for temperatures of 35°C (95°F) and above.

7A.11 TORQUE AVAILABLE.

a. This section presents the maximum dual-engine torque available for the 2.5-minute, 10-minute and 30-minute limits at zero airspeed and 100% RPM R for the operational range of pressure altitude and FAT. The single- and dual-engine transmission limits for continuous operation are also shown and should not be exceeded.



Do not exceed the UH-60L DUAL ENGINE TORQUE LIMITS in Chapter 5. These torque limits are presented in Figure 7A-5 and on the TORQUE PLACARD mounted on the instrument panel.

b. When the TR equals 1.0, the torque available may be read directly from the torque available per engine scales. When the TR is less than 1.0, the actual torque available is determined by multiplying the specification torque available by the TR (example for TR = 0.98: 90% TRQ x 0.98 = 88.2% TRQ). The torque conversion chart (Figure 7A-3) is provided to convert specification data to actual torque available.

7A.11.1 Torque Available - 2.5 Minutes. Figure 7A-4 presents the specification torque available at 903°C TGT per engine for the 2.5 minute limit. Contingency (2.5 Minute) Power is automatically available when any one engine torque is less than 50% or when the pilot selects DEC LOCKOUT and manually maintains the 2.5 minute TGT limit.

7A.11.2 Torque Available - 10 Minutes. Figure 7A-4 presents the specification torque available per engine for the 10 minute limit. This is the maximum dual-engine torque available and is set by the TGT limiter in dual-engine operation. For one engine operation, the pilot must maintain the 10 minute TGT limit.

7A.11.3 Torque Available - 30 Minutes. Figure 7A-4 presents the specification torque available per engine for the 30 minute limit. The pilot must manually maintain the 30 minute TGT limit.

7A.12 ENGINE BLEED AIR.

With engine bleed air on, the available torque per engine is reduced as follows:

a. Engine anti-ice on - 18% TRQ

(example: 90% TRQ - 18% TRQ = 72% TRQ).

b. Cockpit heater on - 4% TRQ.

c. Both on - 22% TRQ.

7A.13 INFRARED SUPPRESSOR SYSTEM.

When the IR suppressor is OPERATING IN THE BENIGN MODE (exhaust baffles removed) the torque available is increased about 1% TRQ.

TORQUE FACTOR

T700-GE-701C ENGINE 100% RPM R

TORQUE FACTOR ~ ATF OR ETF

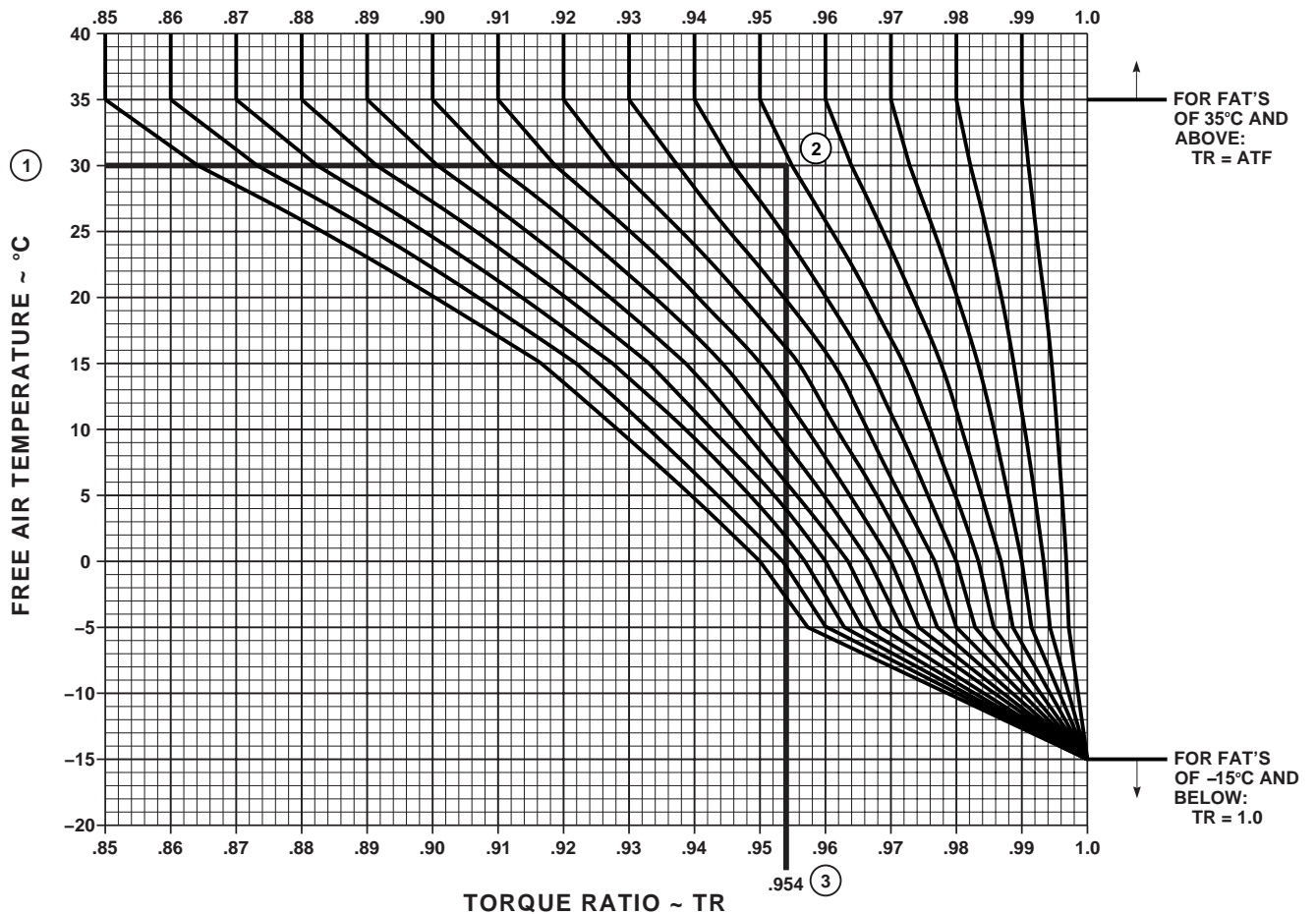

EXAMPLE

WANTED:

TORQUE RATIO AND MAXIMUM TORQUE AVAILABLE – 10-MINUTE LIMIT

KNOWN:

ATF = .95
 PRESSURE ALTITUDE = 6000 FT.
 FAT = 30°C

NOTE

EITHER OF THE TWO TORQUE AVAILABLE CHARTS MAY BE USED. MAXIMUM ALLOWABLE DUAL ENGINE TORQUE LIMITS SHALL NOT BE EXCEEDED.

DATA BASIS: CALCULATED

METHOD:

TO OBTAIN TORQUE RATIO:

1. ENTER TORQUE FACTOR CHART AT KNOWN FAT
2. MOVE RIGHT TO THE ATF VALUE
3. MOVE DOWN, READ TORQUE RATIO = .954.

TO DETERMINE SPECIFICATION TORQUE AVAILABLE – 10-MINUTE LIMITS:

4. ENTER MAXIMUM TORQUE AVAILABLE CHART AT KNOWN FAT (FIGURE 7A-4).
5. MOVE RIGHT TO KNOWN PRESSURE ALTITUDE
6. MOVE DOWN, READ SPECIFICATION TORQUE = 98%.

TO OBTAIN ACTUAL TORQUE VALUE AVAILABLE FROM THE TORQUE CONVERSION CHART:

7. ENTER TORQUE CONVERSION CHART FIGURE 7A-3 AT % TORQUE OBTAINED FROM FIGURE 7A-4.
8. MOVE UP TO TORQUE RATIO OBTAINED FROM FIGURE 7A-2.
9. MOVE LEFT, READ MAXIMUM TORQUE AVAILABLE – 10 MINUTE LIMIT = 93%.
10. ENTER DUAL-ENGINE TORQUE LIMIT CHART FIGURE 7A-5 AT 30°C. MOVE RIGHT TO INTERSECTION AT 6,000 FT. PA. MOVE DOWN TO READ 90.4% TORQUE.

AA0692C
SA

Figure 7A-2. Aircraft Torque Factor (ATF)

7A.14 DUAL-ENGINE TORQUE LIMITS.

■ Helicopters prior to S/N 91-26354 that are not equipped with improved main rotor flight controls are further restricted above 80 KIAS to dual-engine continuous torque

limits as indicated by a placard on the instrument panel. Figure 7A-5 graphically presents the dual-engine torque limits for use with the torque available charts.

TORQUE CONVERSION

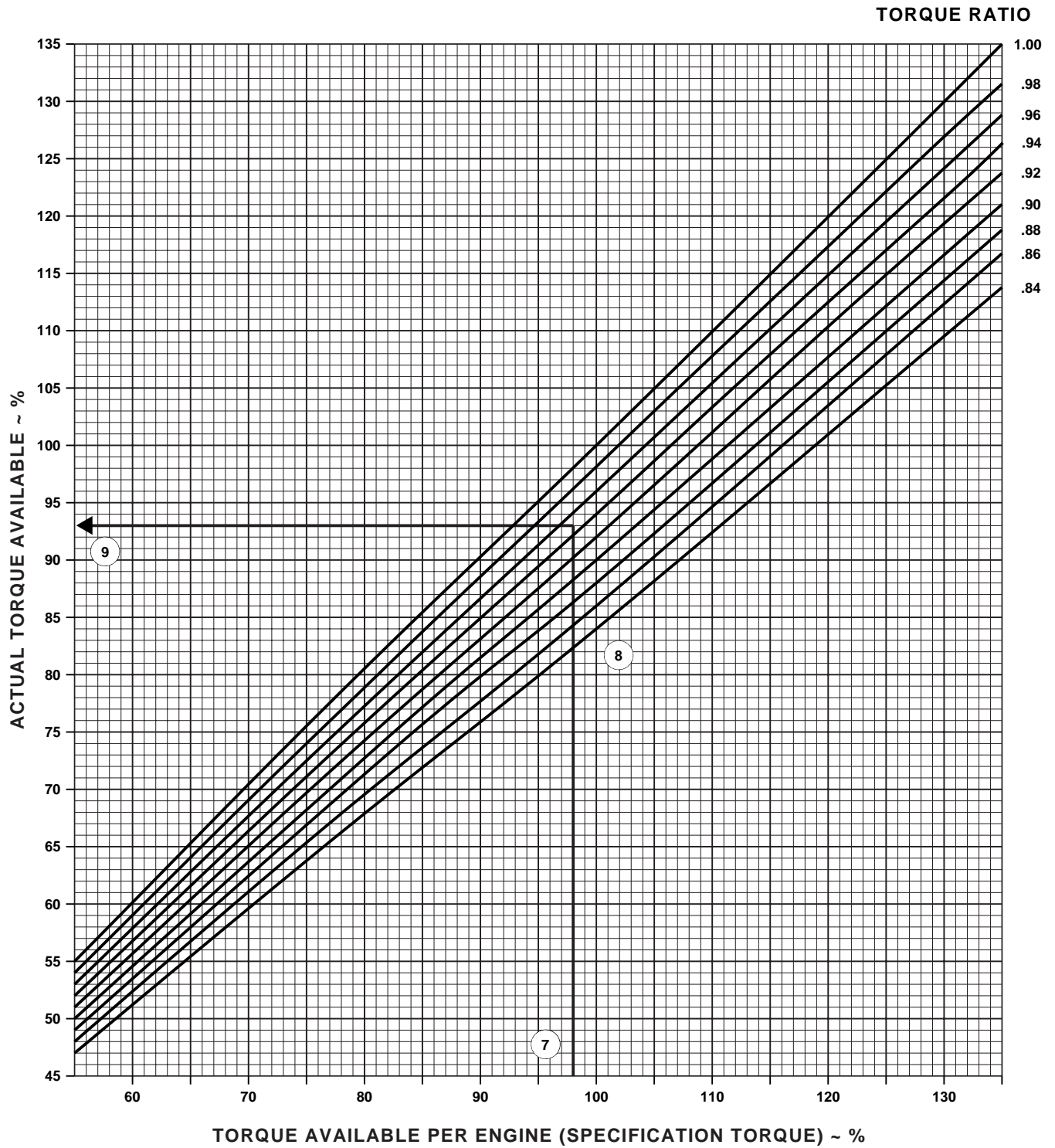

AA1636A
SA

Figure 7A-3. Torque Conversion Chart

MAXIMUM TORQUE AVAILABLE – 2.5-MINUTE LIMIT

T700-GE-701C HIRSS (BAFFLES INSTALLED)

100% RPM R BLEED AIR OFF ZERO AIRSPEED

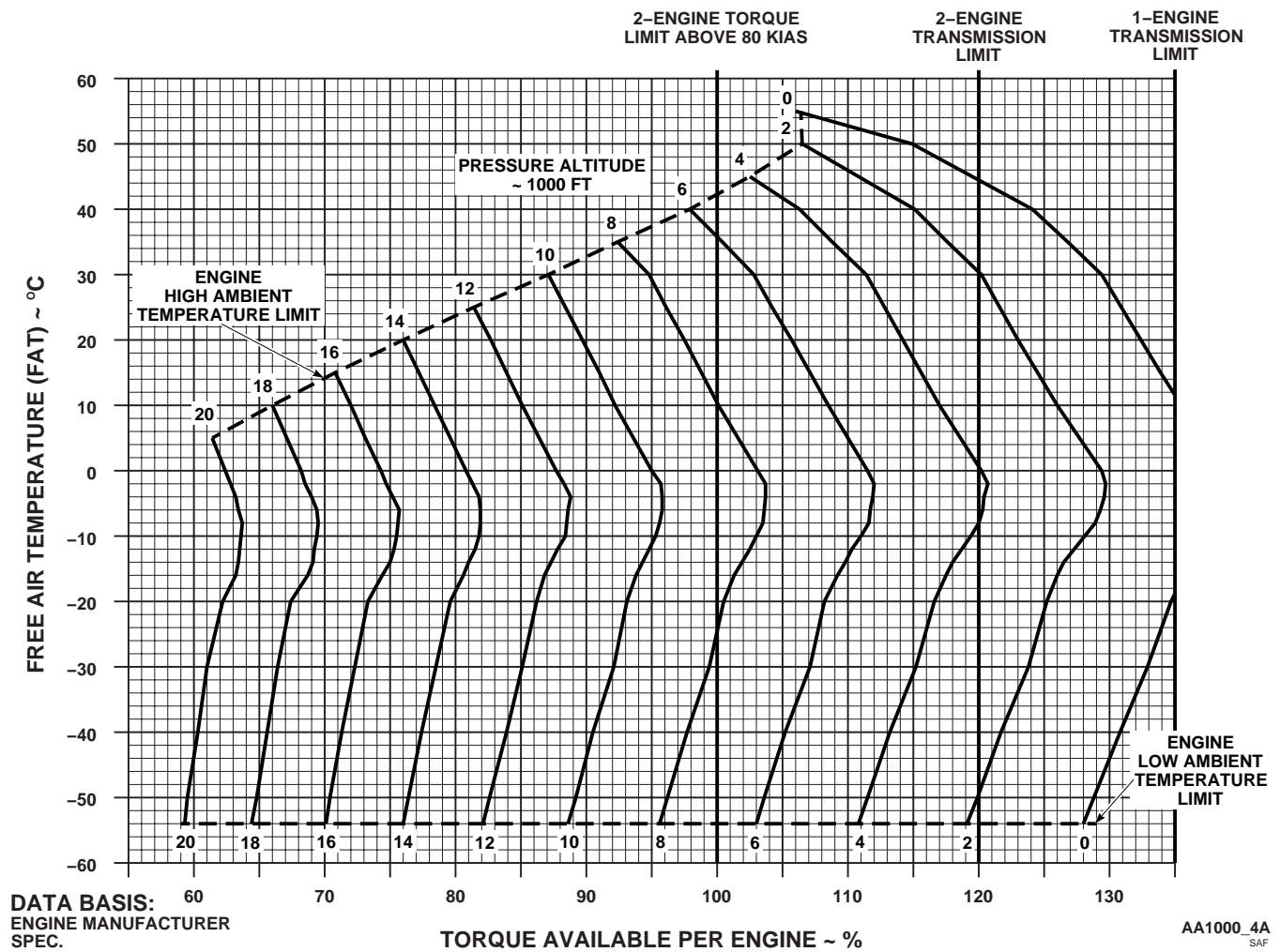

Figure 7A-4. Maximum Torque Available (Sheet 1 of 3)

MAXIMUM TORQUE AVAILABLE – 10-MINUTE LIMIT
T700-GE-701C HIRSS (BAFFLES INSTALLED)
100% RPM R BLEED AIR OFF
ZERO AIRSPEED

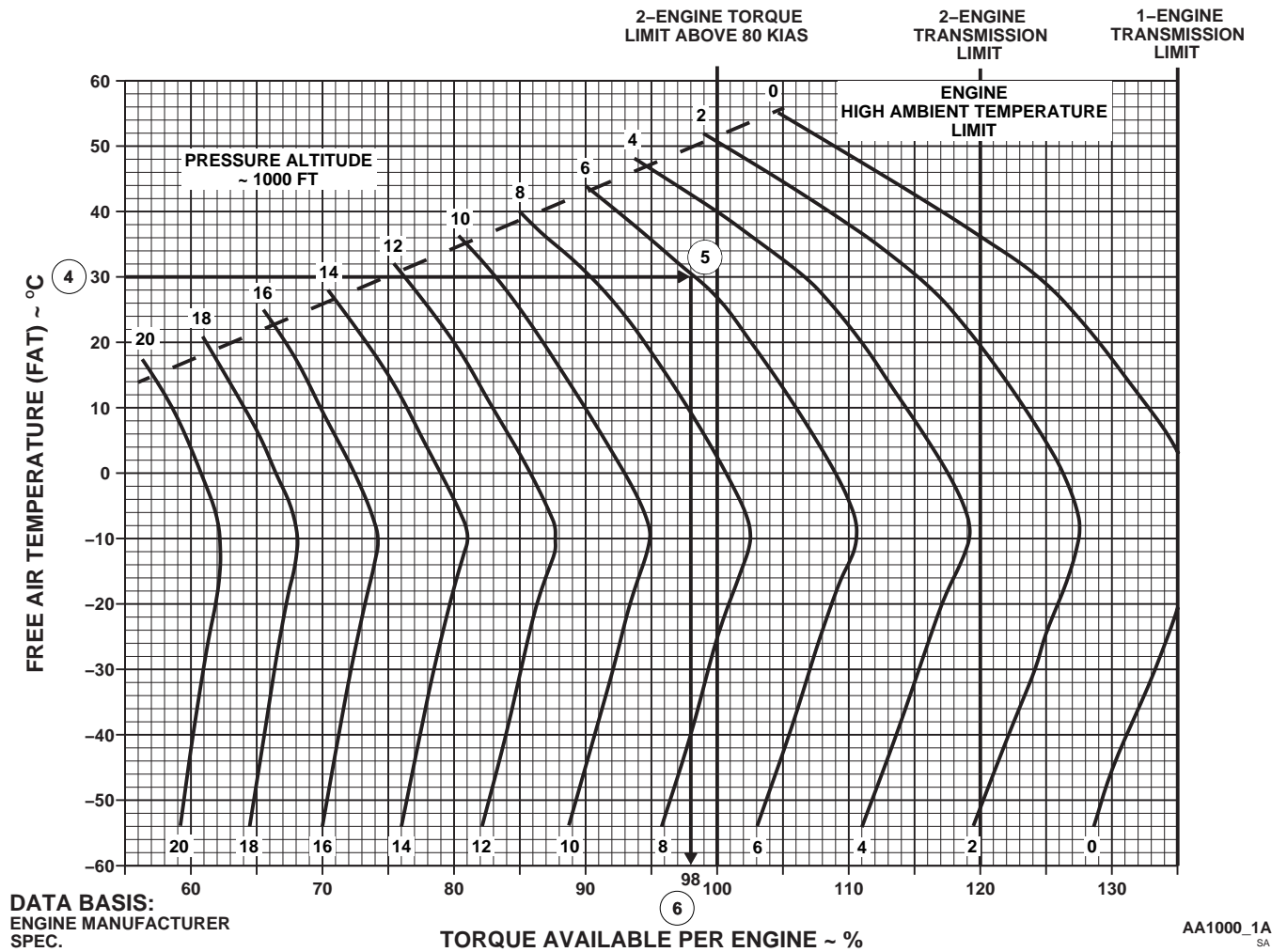

Figure 7A-4. Maximum Torque Available (Sheet 2 of 3)

MAXIMUM TORQUE AVAILABLE – 30-MINUTE LIMIT

T700-GE-701C HIRSS (BAFFLES INSTALLED)
100% RPM R BLEED AIR OFF
ZERO AIRSPEED

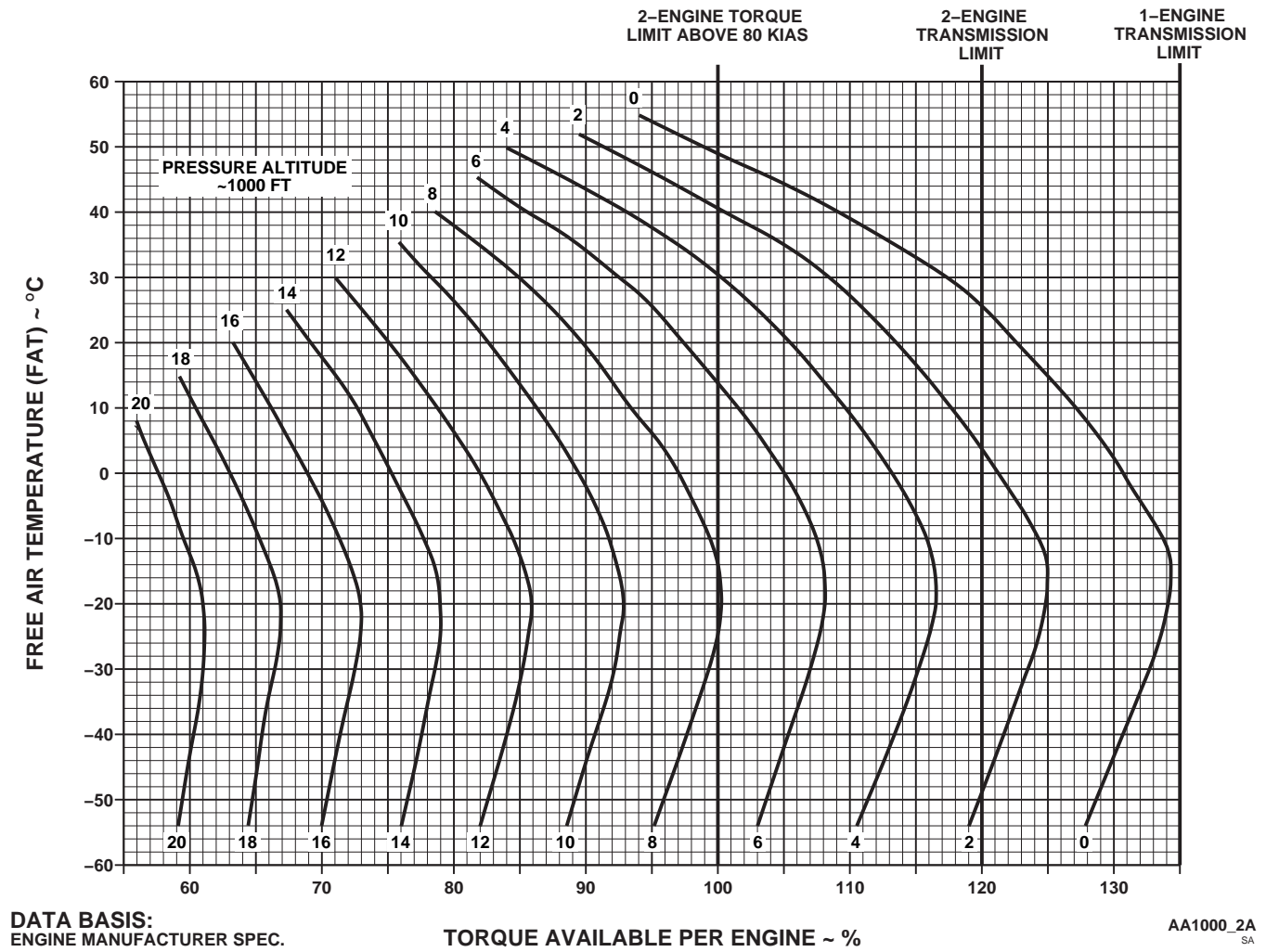

Figure 7A-4. Maximum Torque Available (Sheet 3 of 3)

DUAL-ENGINE TORQUE LIMITS ABOVE 80 KIAS
T-700-GE-701C 100% RPM R
FOR AIRCRAFT WITH TORQUE PLACARD ONLY

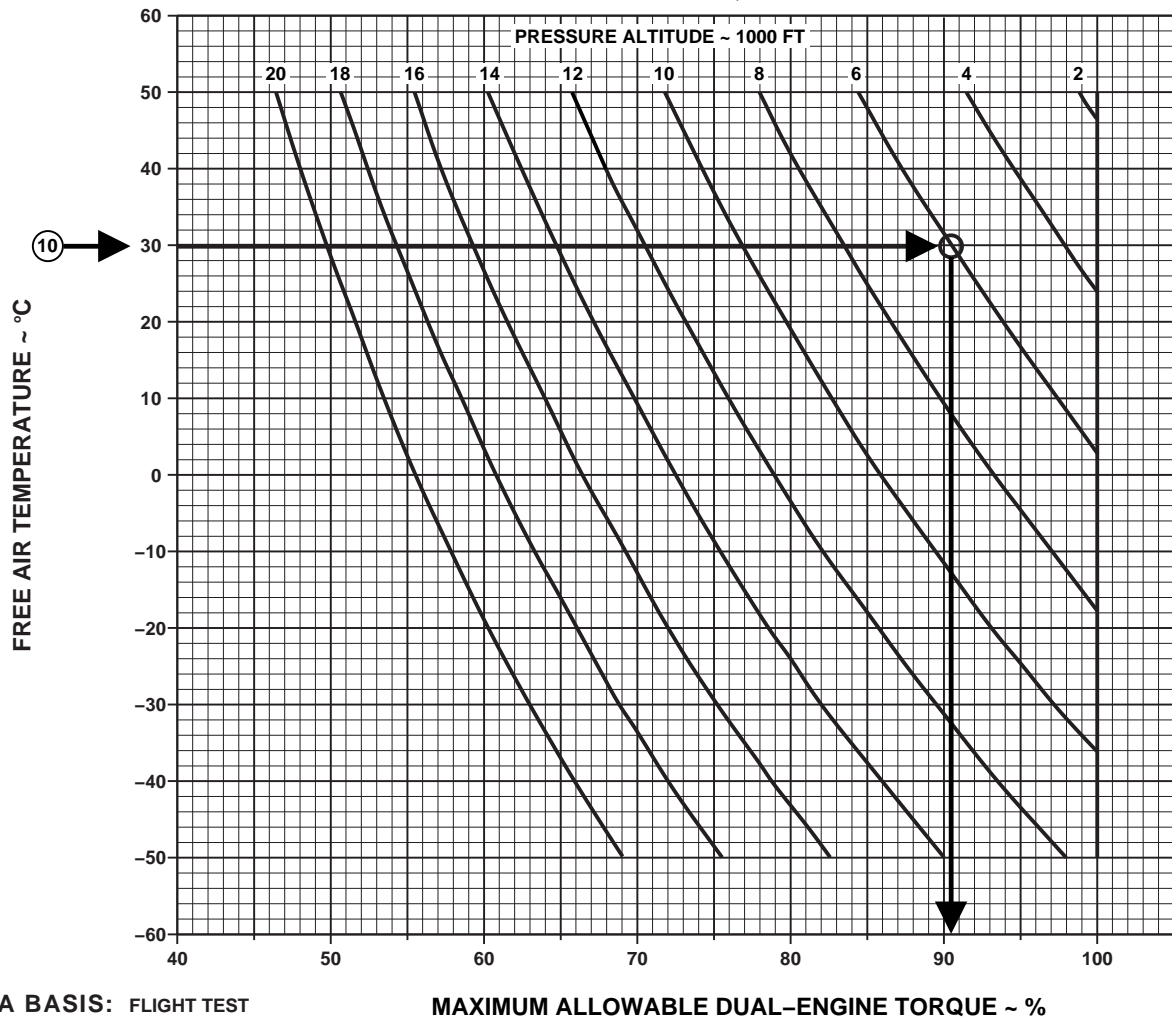

Figure 7A-5. Dual-Engine Torque Limit

Section III HOVER

7A.15 HOVER CHART.

NOTE

VOL For performance calculations with the volcano system installed, use the applicable high drag performance charts.

a. The primary use of the chart (Figures 7A-6 and 7A-7) is illustrated by part A of the example. To determine the torque required to hover, it is necessary to know pressure altitude, free air temperature, gross weight, and desired wheel height. Enter the upper right grid at the known free air temperature, move right to the pressure altitude, move down to gross weight. For OGE hover, move left to torque per engine scale and read torque required. For IGE hover, move left to desired wheel height, deflect down and read torque required for dual-engine or single-engine operation. The IGE wheel height lines represent a compromise for all possible gross weights and altitude conditions. A small torque error up to $\pm 3\%$ torque may occur at extreme temperature and high altitude. This error is more evident at lower wheel heights.

b. In addition to the primary use, the hover chart (Figure 7A-6) may be used to predict maximum hover height. To determine maximum hover height, it is necessary to know pressure altitude, free air temperature, gross weight, and maximum torque available. Enter the known free air temperature move right to the pressure altitude, move down to

gross weight, move left to intersection with maximum torque available and read wheel height. This wheel height is the maximum hover height.

c. The hover chart may also be used to determine maximum gross weight for hover at a given wheel height, pressure altitude, and temperature as illustrated in method B of the example (Figure 7A-6). Enter at known free air temperature, move right to the pressure altitude, then move down and establish a vertical line on the lower grid. Now enter lower left grid at maximum torque available. Move up to wheel height, then move right to intersect vertical line from pressure altitude/FAT intersection. Interpolate from gross weight lines to read maximum gross weight at which the helicopter will hover.

7A.16 EFFECTS OF BLADE EROSION KIT.

With the blade erosion kit installed, it will be necessary to make the following corrections. Multiply the torque required to hover determined from the charts by 1.02. (Example: If indicated torque is 90%, multiply $90 \times 1.02 = 91.8\%$ actual torque required.) Multiply the maximum gross weight to hover obtained from the charts by 0.98. (Example: If gross weight is 22,000 lb, multiply by 0.98 = 21,560 lb actual gross weight to hover.) When determining maximum hover wheel height, enter the chart at 1.02 x gross weight. (Example: If gross weight is 20,000 lb, multiply $20,000 \times 1.02 = 20,400$ lb).

EXAMPLE A

WANTED:

TORQUE REQUIRED TO HOVER OGE AND AT A 10-FOOT WHEEL HEIGHT

KNOWN:

FAT = 30°C
PRESSURE ALTITUDE = 3,000 FEET
GROSS WEIGHT = 19,500 POUNDS

METHOD:

ENTER HOVER CHART AT KNOWN FAT. MOVE RIGHT TO PRESSURE ALTITUDE, MOVE DOWN THROUGH GROSS WEIGHT LINES TO DESIRED GROSS WEIGHT. MOVE LEFT TO INDICATE TORQUE/ENGINE % (OGE) SCALE AND READ OGE HOVER TORQUE (95%). MOVE DOWN FROM INTERSECTION OF 10-FOOT HOVER LINE AND HORIZONTAL LINE TO READ TORQUE REQUIRED TO HOVER 10 FEET (80%).

EXAMPLE B

WANTED:

MAXIMUM GROSS WEIGHT TO HOVER OGE

KNOWN:

ATF = 1.0
FAT = 20°C
PRESSURE ALTITUDE = 5,000 FEET
MAXIMUM TORQUE AVAILABLE = 107%

METHOD:

ENTER INDICATED TORQUE/ENGINE (IGE) SCALE AT MAXIMUM TORQUE AVAILABLE (107%), MOVE UP TO OGE LINE. ENTER CHART AT KNOWN FAT (20°C). MOVE RIGHT TO PRESSURE ALTITUDE LINE. MOVE DOWN FROM PRESSURE ALTITUDE LINE AND MOVE RIGHT FROM OGE LINE. WHERE LINES INTERSECT, READ MAXIMUM GROSS WEIGHT TO HOVER OGE (20,500 lb).

Figure 7A-6. Hover - Clean (Sheet 1 of 2)



HOVER HIGH DRAG CONFIGURATION 100% RPM R ZERO WIND

NOTE
FOR LOW WIND CONDITIONS AIRCRAFT SHOULD BE HEADED INTO WIND. 3-5 KT CROSSWIND OR TAILWIND MAY INCREASE TORQUE REQUIRED BY UP TO 4% OVER ZERO WIND VALUES

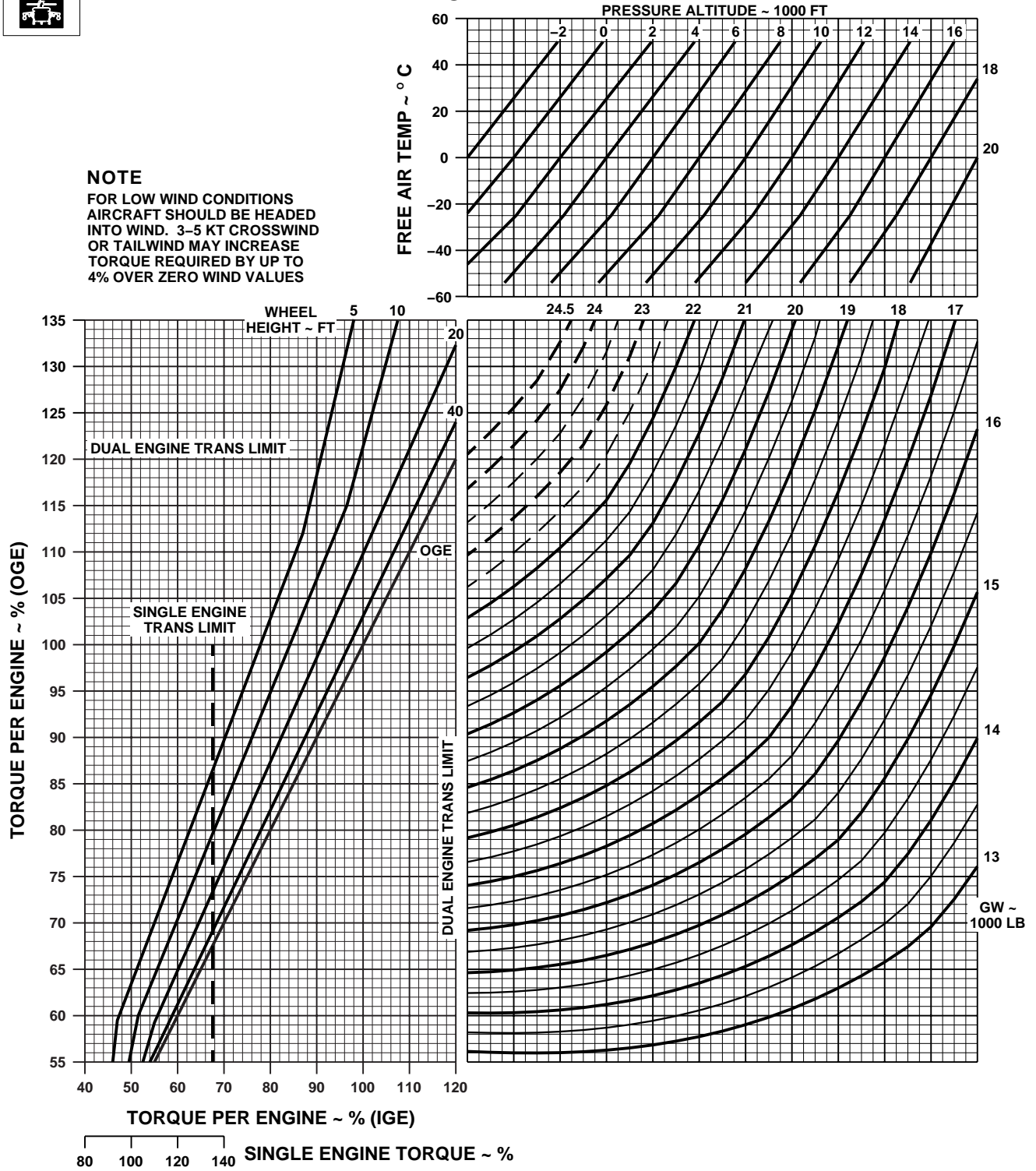

DATA BASIS : FLIGHT TEST

AA2147C
SAF

Figure 7A-7. Hover - High Drag

Section IV CRUISE

7A.17 DESCRIPTION.

The cruise charts (Figures 7A-8 through 7A-30) present torque required and total fuel flow as a function of airspeed, altitude, temperature, and gross weight at 100% rotor speed. Scales for both true airspeed and indicated airspeed are presented. The baseline aircraft configurations for these charts are "clean and high drag" configuration as defined in Section I. Each cruise chart also presents the change in torque (Δ TRQ) required for 10 sq. ft. of additional flat plate drag with a dashed line on a separate scale. This line is utilized to correct torque required for external loads as discussed in Section VI DRAG. Maximum level flight airspeed (Vh) is obtained at the intersection of gross weight arc and torque available - 30 minutes or the transmission torque limit, whichever is lower. Airspeeds that will produce maximum range, maximum endurance, and maximum rate of climb are also shown. Cruise charts are provided from sea level to 20,000 feet pressure altitude in units of 2,000 feet. Each figure number represents a different altitude. The charts provide cruise data for free air temperatures from -50° to +60°C, in units of 10°. Charts with FAT's that exceed the engine ambient temperature limits by more than 10°C are deleted.

7A.18 USE OF CHARTS.

The primary uses of the charts are illustrated by the examples of Figure 7A-8. To use the charts, it is usually necessary to know the planned pressure altitude, estimated free air temperature, planned cruise speed, TAS, and gross weight. First, select the proper chart on the basis of pressure altitude and FAT. Enter the chart at the cruise airspeed, IAS, move horizontal and read TAS, move horizontal to the gross weight, move down and read torque required, and then move up and read associated fuel flow. Maximum performance conditions are determined by entering the chart where the maximum range line or the maximum endurance and rate of climb line intersects the gross weight line; then read airspeed, fuel flow, and torque required. Normally, sufficient accuracy can be obtained by selecting the chart nearest the planned cruising altitude and FAT or, more conservatively, by selecting the chart with the next higher altitude and FAT. If greater accuracy is required, interpolation between altitudes and/or temperatures is permissible. To be conservative, use the gross weight at the beginning of the cruise flight. For greater accuracy on long flights, however, it is preferable to determine cruise information for several flight segments to allow for the decreasing gross weight.

a. Airspeed. True and indicated airspeeds are presented at opposite sides of each chart. On any chart, indicated airspeed can be directly converted to true airspeed (or vice versa) by reading directly across the chart without regard for the other chart information.

b. Torque. Since pressure altitude and temperature are fixed for each chart, torque required varies according to gross weight and airspeed. The torque and torque limits shown on these charts are for dual-engine operation. The maximum torque available is presented on each chart as either the transmission torque limit or torque available - 30 minute for both ATF-1.0 and 0.9 values. The maximum torque available for aircraft with an ATF value between these must be interpolated. The continuous torque available values shown represent the minimum torque available for ATF's of 0.95 or greater. For ATF's less than 0.95 maximum continuous torque available may be slightly reduced. The dual-engine torque limit placard value is presented below the torque scale of each chart when applicable. An increase or decrease in torque required because of a drag area change is calculated by adding or subtracting the change in torque from the torque on the curve, and then reading the new fuel flow total.

c. Fuel Flow. Fuel flow scales are provided opposite the torque scales. On any chart, torque may be converted directly to fuel flow without regard to other chart information. Data shown in this section is for two-engine operation. For one-engine fuel flow, refer to Section VIII FUEL FLOW.

(1) With bleed-air extracted, fuel flow increases:

(a) Engine anti-ice on - About 100 lbs/hr. Example:
(760 lbs/hr + 100 lbs/hr = 860 lbs/hr.)

(b) Heater on - About 12 lbs/hr.

(c) Both on - About 112 lbs/hr.

(2) When the hover IR suppressor system is operating in the benign mode (exhaust baffles removed), the dual-engine fuel flow will decrease about 14 lbs/hr.

d. Maximum Range. The maximum range lines (MAX RANGE) indicate the combinations of gross weight and airspeed that will produce the greatest flight range per pound of fuel under zero wind conditions. When maximum

range airspeed line is above the maximum torque available, the resulting maximum airspeed should be used for maximum range. A method of estimating maximum range speed in winds is to increase IAS by 2.5 knots per each 10 knots of effective headwind (which reduces flight time and minimizes loss in range) and decrease IAS by 2.5 knots per 10 knots of effective tailwind for economy.

e. Maximum Endurance and Rate of Climb. The maximum endurance and rate of climb lines (MAX END and R/C) indicate the combinations of gross weight and airspeed that will produce the maximum endurance and the maximum rate of climb. The torque required for level flight at this condition is a minimum, providing a minimum fuel flow (maximum endurance) and a maximum torque change available for climb (maximum rate of climb).

f. Change in Frontal Area. Since the cruise information is given for the "clean and high drag configuration," adjustments to torque should be made when operating with external sling loads or aircraft external configuration changes. To determine the change in torque, first obtain the appropriate multiplying factor from the drag load chart (Figure 7A-33 or Table 7A-1), then enter the cruise chart at the planned cruise speed TAS, move right to the broken Δ TRQ line, and move up and read Δ TRQ. Multiply Δ TRQ by the multiplying factor to obtain change in torque, then add or subtract change in torque from torque required for the primary mission configuration. Enter the cruise chart at resulting torque required, move up, and read fuel flow. If the resulting torque required exceeds the governing torque limit, the torque required must be reduced to the limit. The resulting reduction in airspeed may be found by subtracting the change in torque from the limit torque; then enter the cruise chart at the reduced torque, and move up to the gross weight. Move left or right to read TAS or IAS. The engine torque setting for maximum range obtained from the clean configuration cruise chart will generally result in cruise at best range airspeed for the higher drag configuration. To determine the approximate airspeed for maximum range for alternative or external load configurations, reduce the value from the cruise chart by 6 knots for each 10 square foot increase in drag area, Δ F. For example, if both cabin doors are open the Δ F increases 6 ft² and the maximum range airspeed would be reduced by

approximately 4 knots ($6 \text{ Kts}/10 \text{ ft}^2 \times 6 \text{ ft}^2 = 3.6 \text{ Kts}$). Only the high drag cruise charts have data for gross weights above 22,000 pounds. For external cargo hook load operations in excess of 8,000 pounds that attain gross weights from 22,000 to 23,500 pounds it will be necessary to use the high drag cruise charts. If the external stores support system (ESSS) and the two 230-gallon tanks are not installed and the estimated drag value for the cargo hook load is greater than 14 square feet, it will be necessary to subtract 14 square feet of drag from the cruise chart drag value when determining cruise performance. If the ESSS and the two 230-gallon tanks are not installed and the drag is estimated to be 14 square feet or less, the high drag charts should be used with no other correction.

g. Additional Uses. The low speed end of the cruise chart (below 40 knots) is shown primarily to familiarize you with the low speed power requirements of the helicopter. It shows the power margin available for climb or acceleration during maneuvers, such as NOE flight. At zero airspeed, the torque represents the torque required to hover out of ground effect. In general, mission planning for low speed flight should be based on hover out of ground effect.

7A.19 SINGLE-ENGINE.

a. The minimum or maximum single-engine speeds can be determined by using a combination of the 701C torque available and cruise charts. To calculate single-engine speeds, first determine the torque available from Section II at the TGT limit desired and divide by 2. (Example: $90\% \text{ TRQ} \div 2 = 45\% \text{ TRQ}$.)

b. Select the appropriate cruise chart for the desired flight condition and enter the torque scale with the torque value derived above. Move up to the intersection of torque available and the mission gross weight arc, and read across for minimum single-engine airspeed. Move up to the second intersection of torque and weight, and read across to determine the maximum single-engine speed. If no intersections occur, there is no single-engine level flight capability for the conditions. Single-engine fuel flow at the desired 10 minute, 30 minute, continuous conditions may be obtained by doubling the torque required from the cruise chart and referring to Figure 7A-37.

CRUISE EXAMPLE CLEAN CONFIGURATION 100% RPM R

FAT: 30° C ALT: 6,000 FT
TOTAL FUEL FLOW 100 LB/HR

EXAMPLE

WANTED

- A. CRUISE CONDITIONS FOR MAXIMUM RANGE
- B. CONDITIONS FOR MAXIMUM ENDURANCE
- C. MAXIMUM AIRSPEED IN LEVEL FLIGHT REQUIRED TO CRUISE WITH CARGO DOORS OPEN
- D. DETERMINE TORQUE AND FUEL FLOW

KNOWN

FAT = 30°C
PRESSURE ALTITUDE = 6000 FT
GW = 17000 LBS
ATF = 0.95
PLACARD TORQUE LIMITS APPLY

METHOD

- A. TURN TO CRUISE CHARTS NEAREST KNOWN FLIGHT CONDITIONS, AT INTERSECTION OF MAX RANGE LINE AND KNOWN VALUE OF GROSS WEIGHT:
 - MOVE LEFT, READ TAS = 137 KTS
 - MOVE RIGHT, READ IAS = 121 KTS
 - MOVE DOWN, READ TORQUE = 63% TRQ
 - MOVE UP, READ TOTAL FUEL FLOW = 970 LBS / HR
- B. AT INTERSECTION OF MAX END AND R / C LINE AND KNOWN VALUE OF GROSS WEIGHT:
 - MOVE LEFT, READ TAS = 81 KTS
 - MOVE RIGHT, READ IAS = 66 KTS
 - MOVE DOWN, READ TORQUE = 40% TRQ
 - MOVE UP, READ TOTAL FUEL FLOW = 740 LBS / HR
- C. THE 30-MINUTE TORQUE AVAILABLE FOR AN ATF OF 0.95 IS ABOVE THE PLACARD TORQUE LIMIT. THEREFORE, AT THE INTERSECTION OF GROSS WEIGHT AND 90% TRQ:
 - MOVE LEFT, READ MAXIMUM TAS = 157 KTS
 - MOVE RIGHT, READ MAXIMUM IAS = 139 KTS
 - MOVE DOWN, READ MAXIMUM TORQUE = 90% TRQ
 - MOVE UP, READ TOTAL FUEL FLOW = 1250 LBS / HR
- D. ENTER Δ TRQ% PER 10 SQ FT SCALE AT 137 KTAS
 - MOVE UP READ Δ TRQ = 9.0%
 - TURN TO DRAG TABLE IN SECTION VII
 - NOTE CARGO DOORS OPEN = 6.0 SQ FT Δ F
 - AND HAS A DRAG MULTIPLYING FACTOR VALUE OF 0.60, CALCULATE TOTAL TORQUE REQUIRED USING THE CONDITIONS OF EXAMPLE A:
 - $63\% + (0.6 \times 9.0\%) = 68.4\%$ TRQ
 - READ FUEL FLOW AT TOTAL TORQUE = 1025 LBS / HR

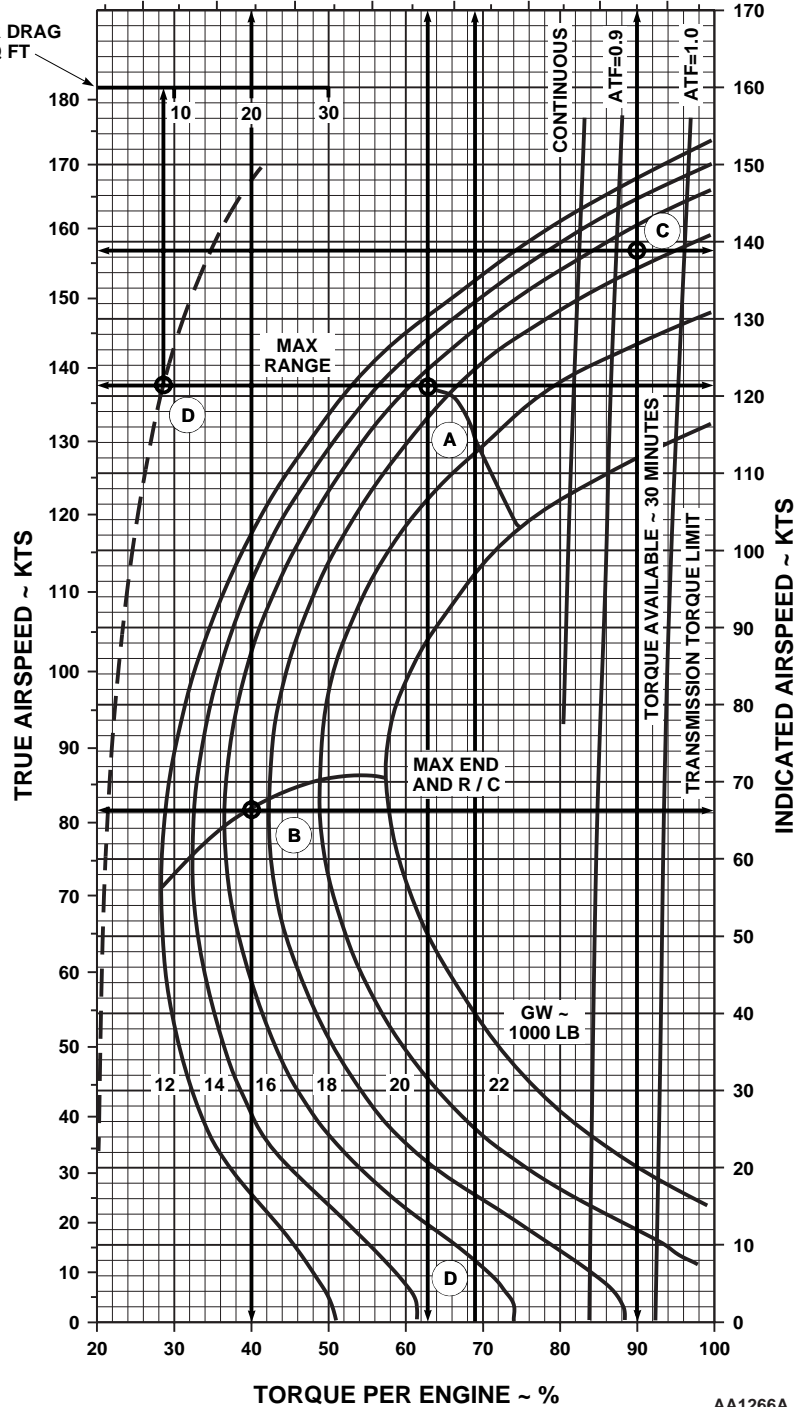

AA1266A
SA

Figure 7A-8. Sample Cruise Chart

CRUISE

CLEAN CONFIGURATION

PRESS ALT: 0 FT

CRUISE
0 FT
T701C (2)

-50°C

-40°C

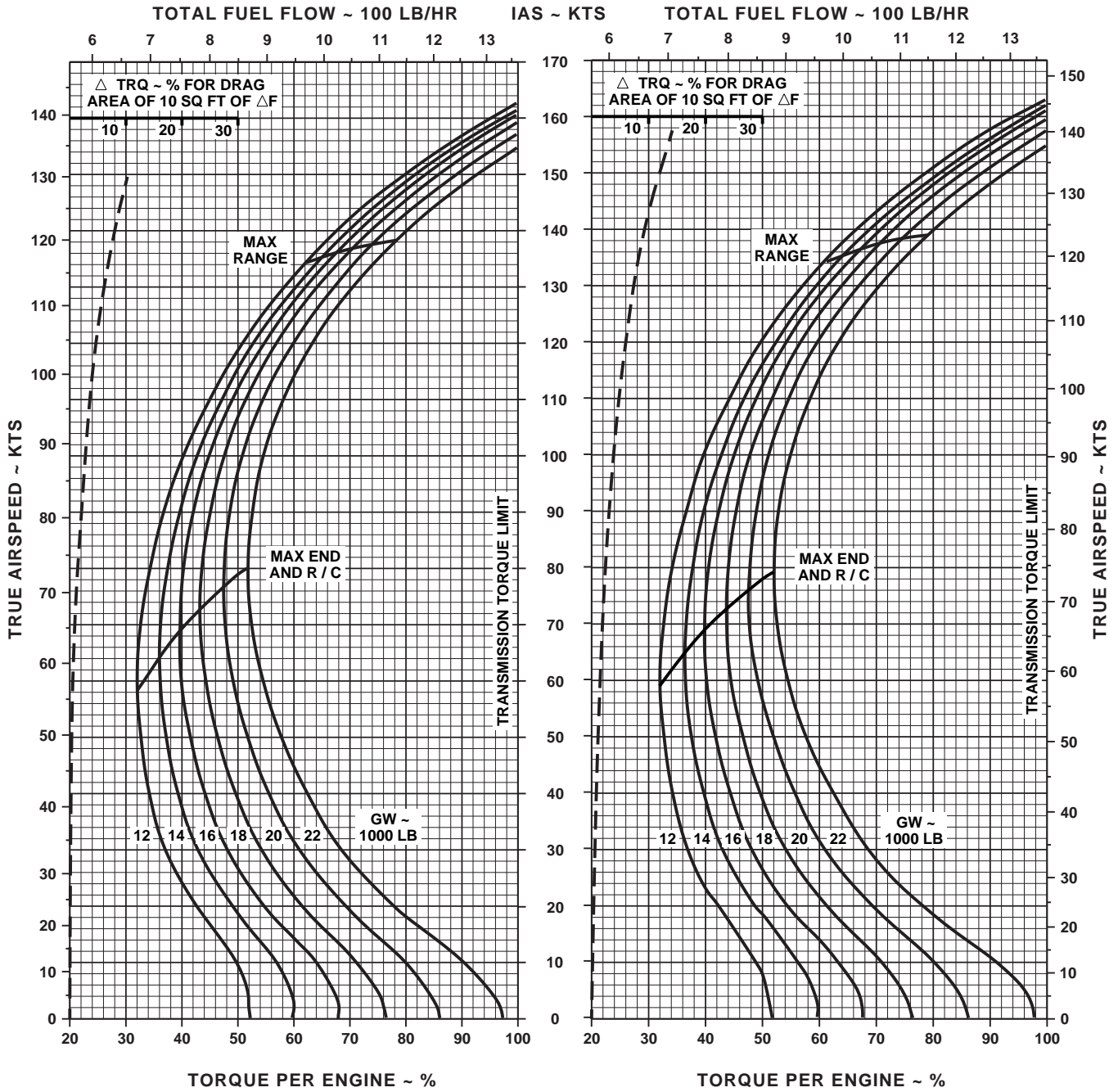

DATA BASE: FLIGHT TEST

AA1060_1
SA

Figure 7A-9. Cruise - Pressure Altitude Sea Level (Sheet 1 of 6)

CRUISE

CLEAN CONFIGURATION

PRESS ALT: 0 FT

CRUISE
0 FT
T701C (2)

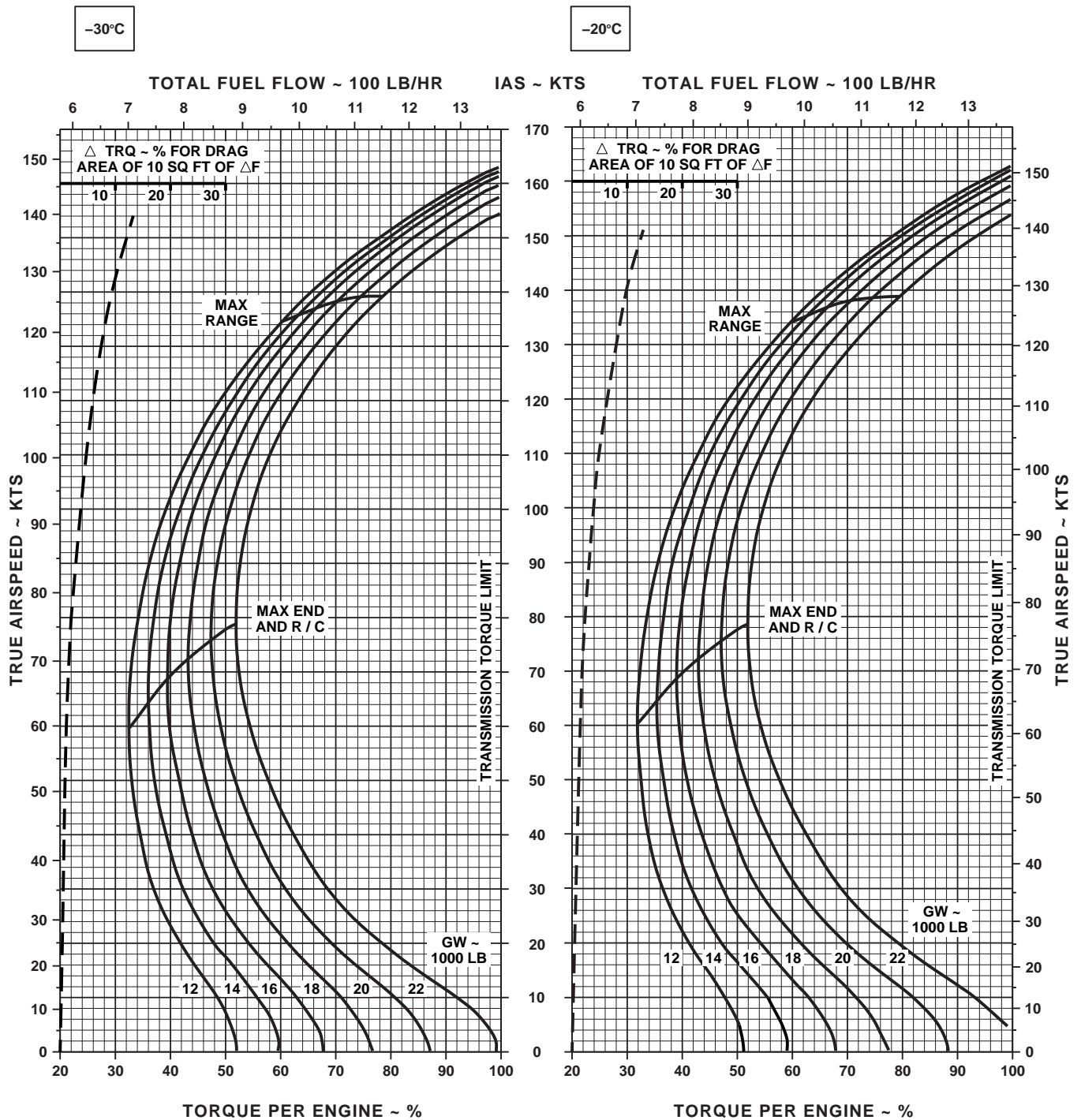

DATA BASE: FLIGHT TEST

AA1060_2
SA

Figure 7A-9. Cruise - Pressure Altitude Sea Level (Sheet 2 of 6)

CRUISE

CLEAN CONFIGURATION

PRESS ALT: 0 FT

CRUISE
0 FT
T701C (2)

-10°C

0°C

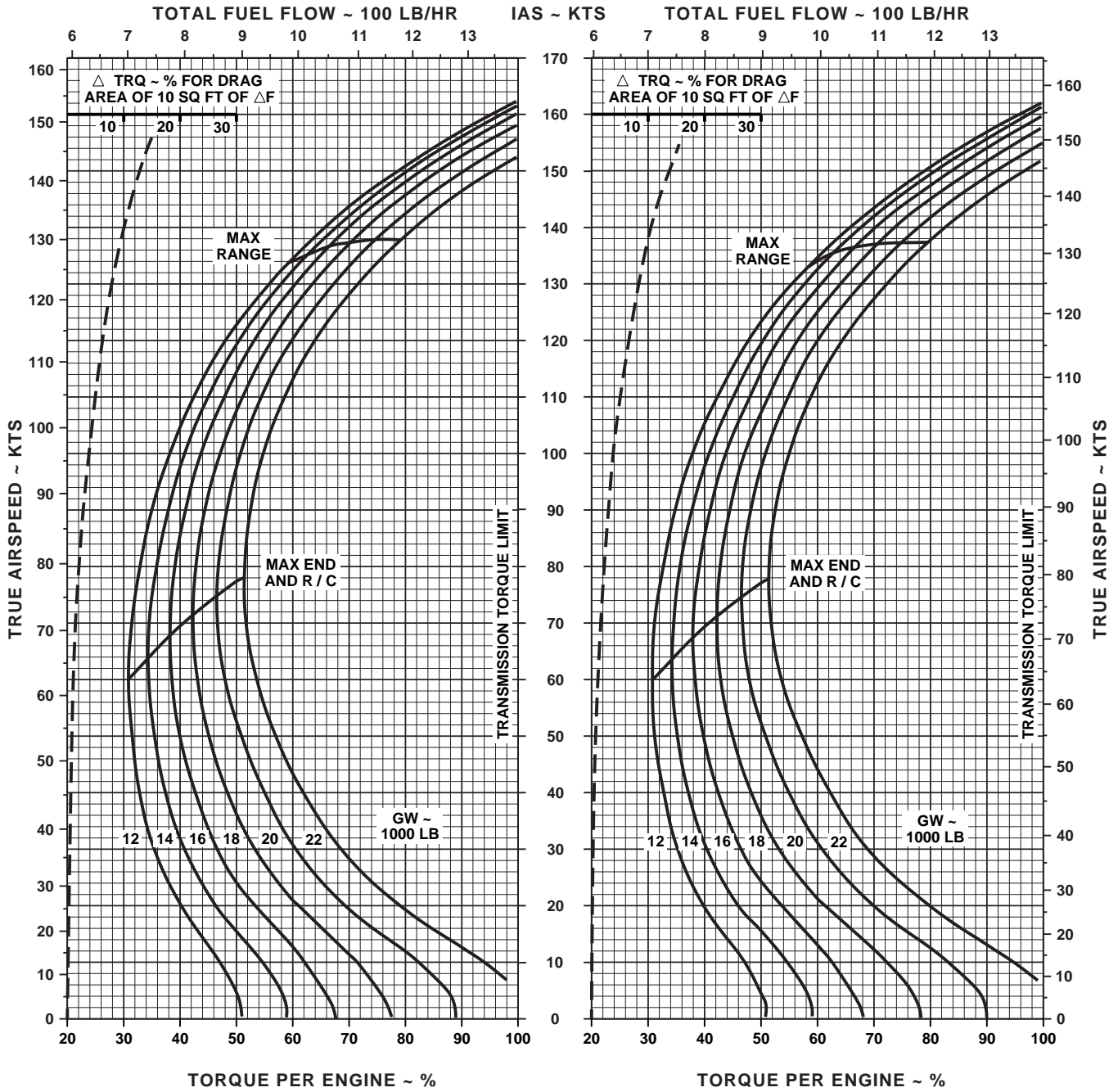

DATA BASE: FLIGHT TEST

AA1060_3
SA

Figure 7A-9. Cruise - Pressure Altitude Sea Level (Sheet 3 of 6)

CRUISE

CLEAN CONFIGURATION

PRESS ALT: 0 FT

CRUISE
0 FT
T701C (2)

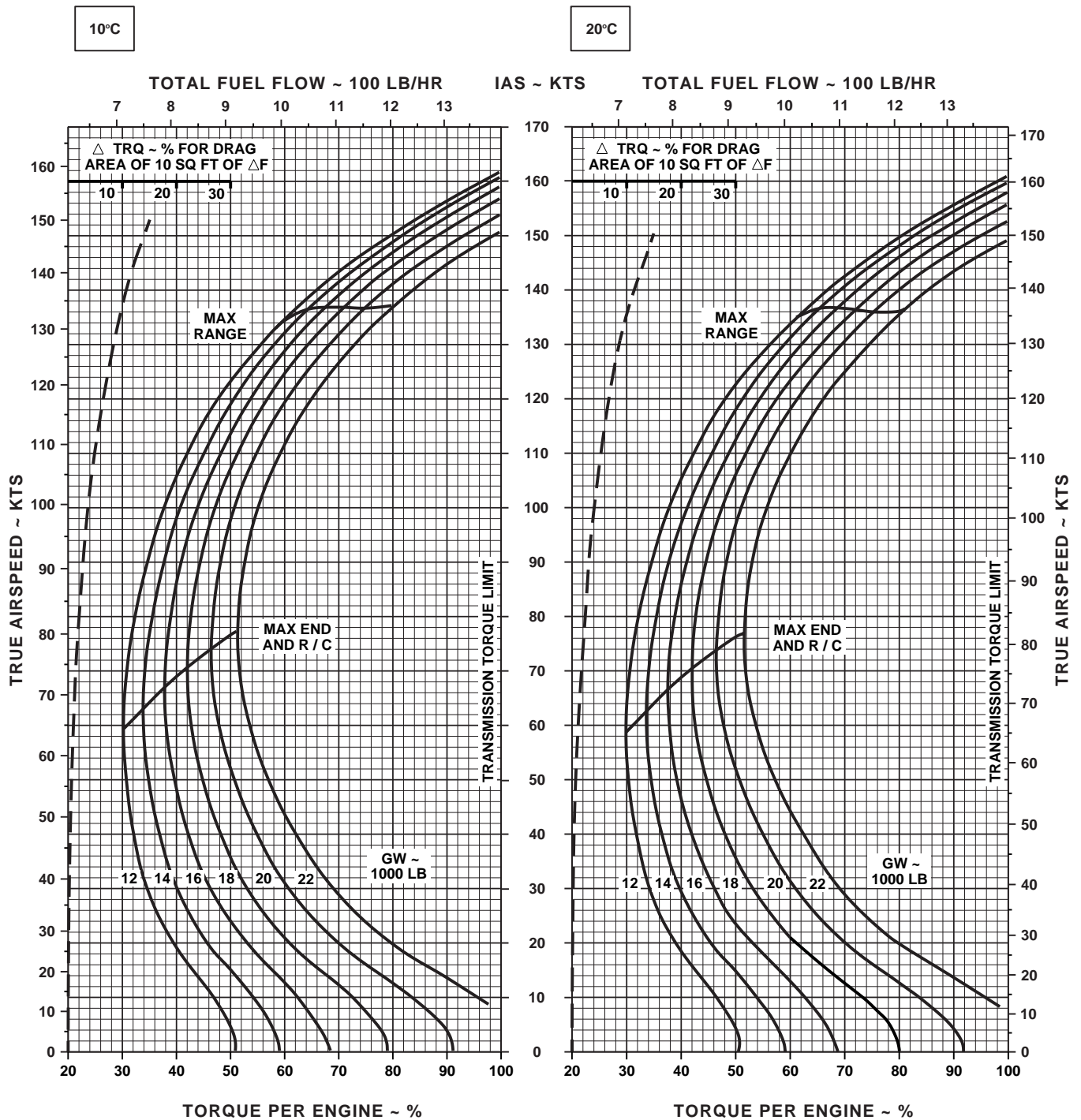

DATA BASE: FLIGHT TEST

AA1060_4
SA

Figure 7A-9. Cruise - Pressure Altitude Sea Level (Sheet 4 of 6)

CRUISE

CLEAN CONFIGURATION

PRESS ALT: 0 FT

CRUISE
0 FT
T701C (2)

30°C

40°C

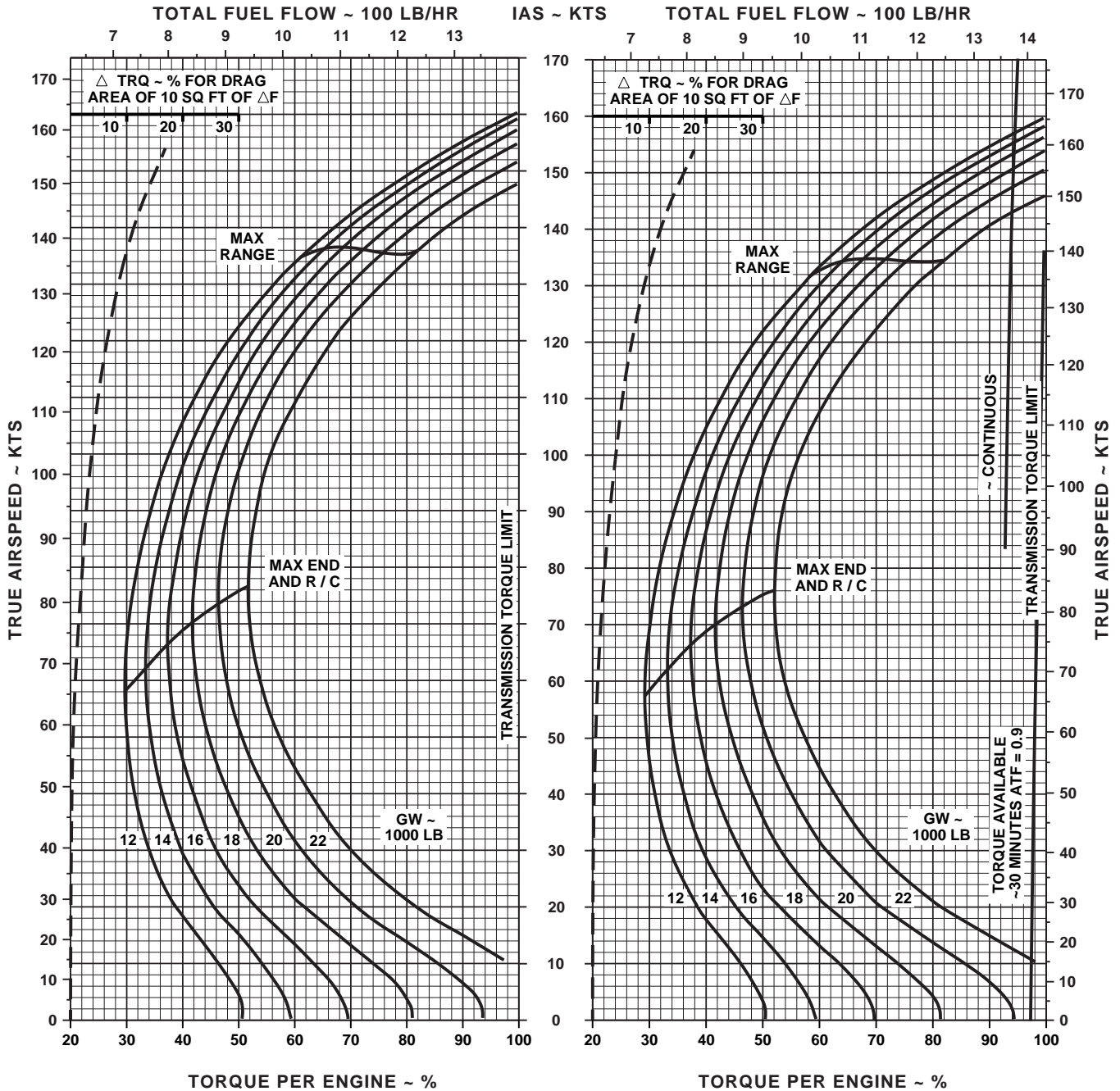

DATA BASE: FLIGHT TEST

AA1060_5
SA

Figure 7A-9. Cruise - Pressure Altitude Sea Level (Sheet 5 of 6)

CRUISE CLEAN CONFIGURATION PRESS ALT: 0 FT

CRUISE
0 FT
T701C (2)

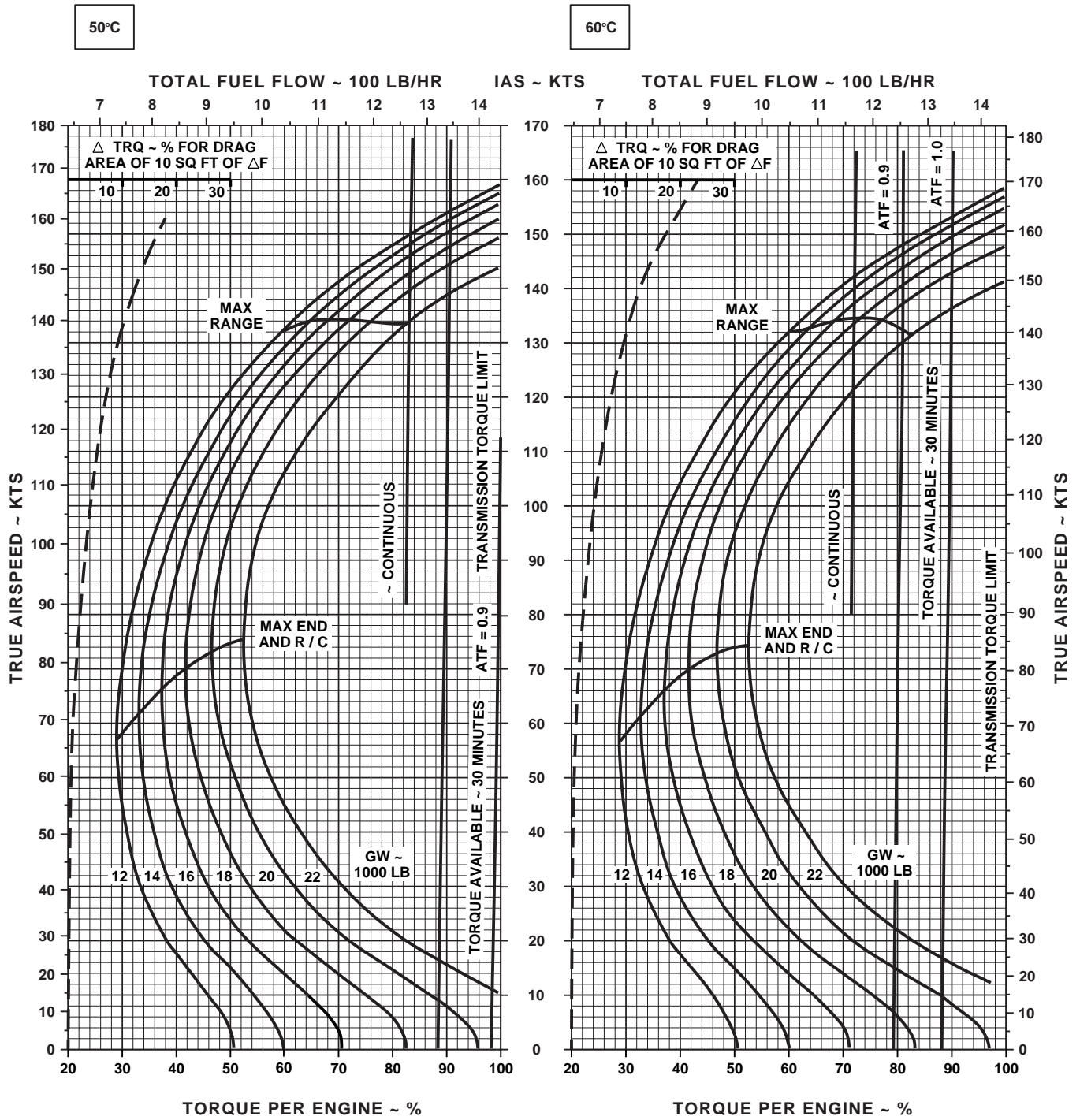

DATA BASE: FLIGHT TEST

AA1060_6
SA

Figure 7A-9. Cruise - Pressure Altitude Sea Level (Sheet 6 of 6)

CRUISE

PRESS ALT: 0 FT

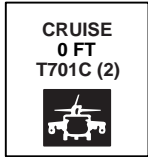

-50°C

-40°C

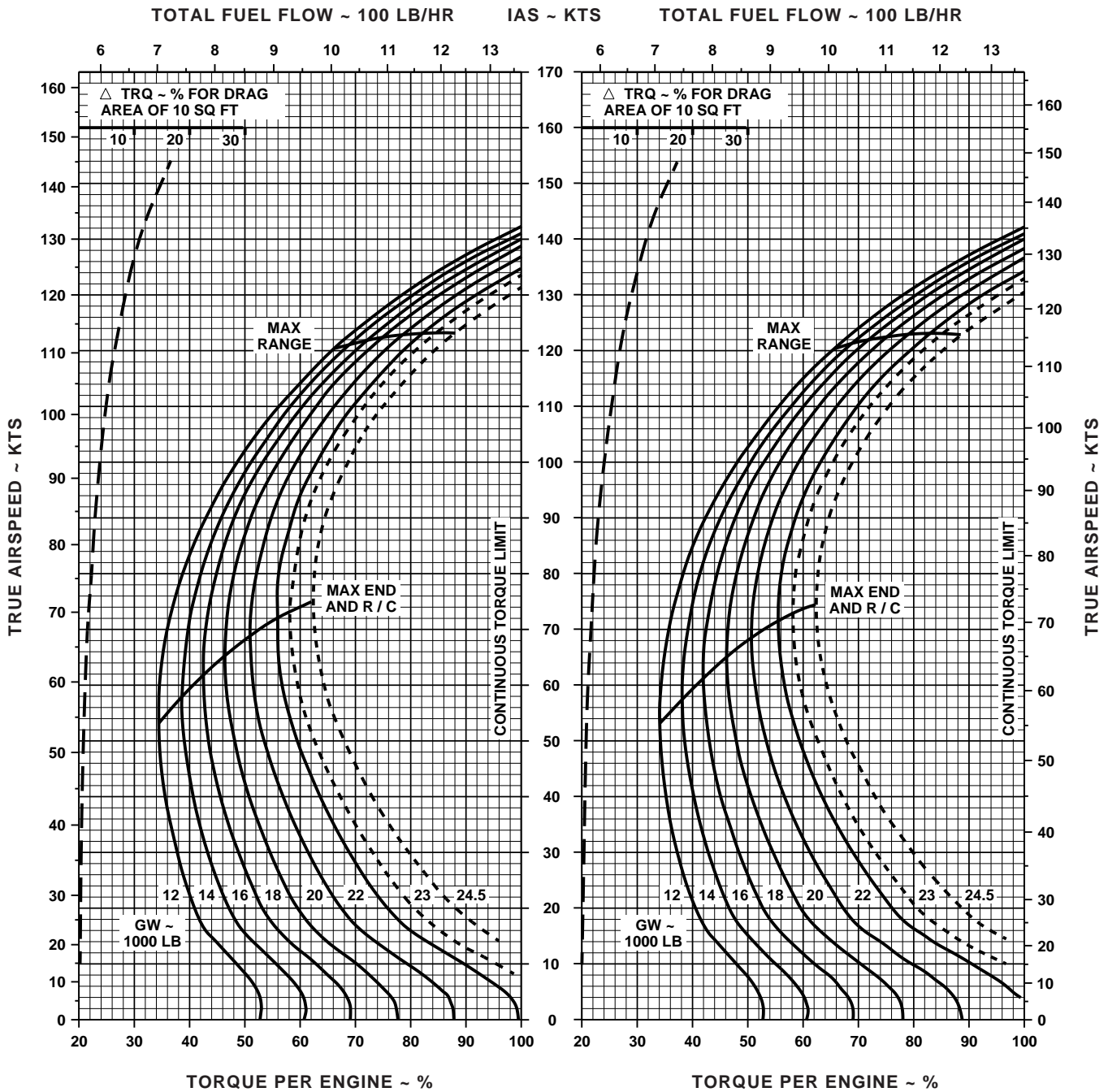

NOTE: SHORT DASH LINES: FERRY MISSION ONLY
 DATA BASE: FLIGHT TEST

AA1065_1
 SA

Figure 7A-10. Cruise High Drag - Pressure Altitude Sea Level (Sheet 1 of 6)

CRUISE

PRESS ALT: 0 FT

CRUISE
0 FT
T701C (2)

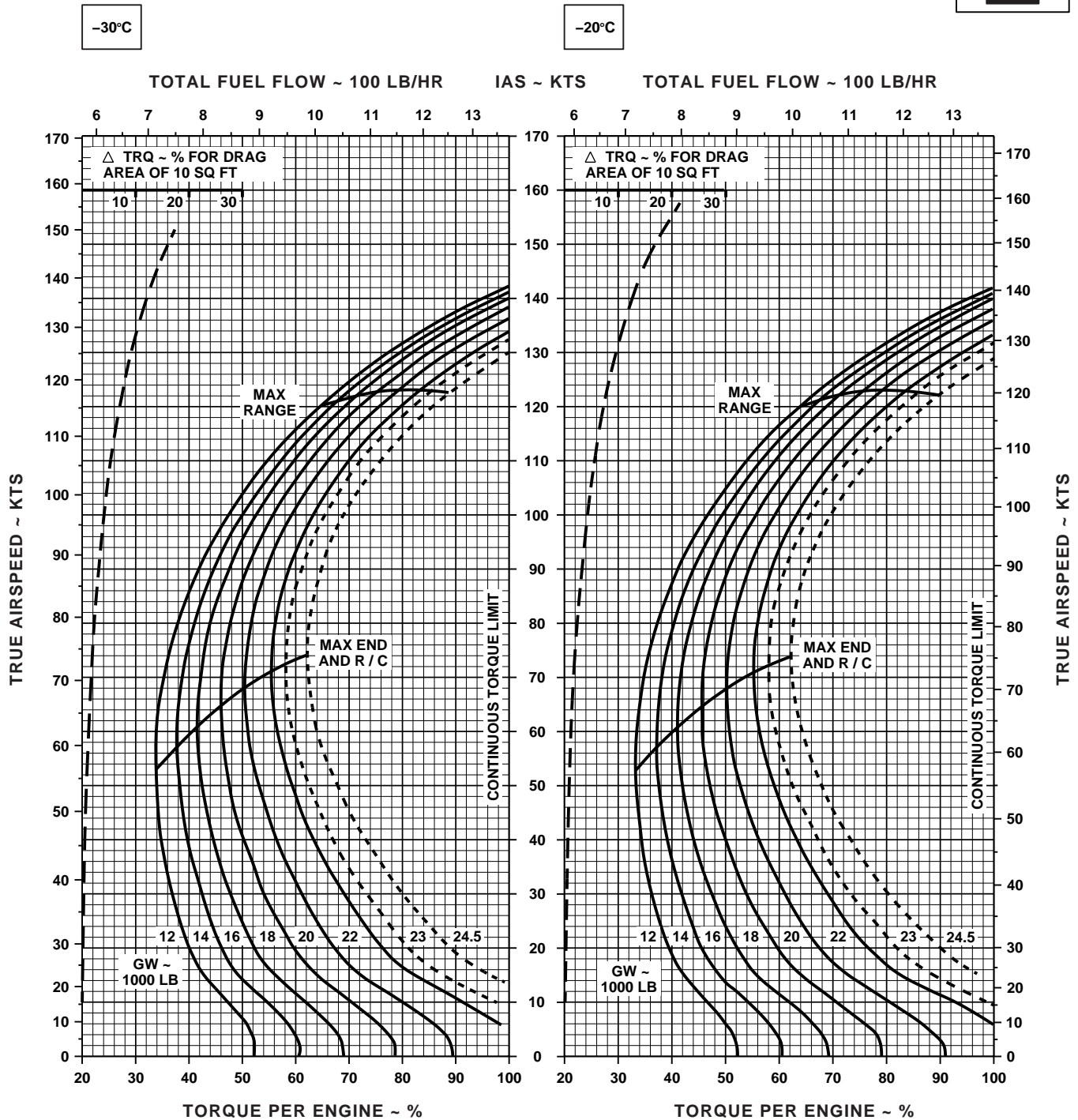
NOTE: SHORT DASH LINES: FERRY MISSION ONLY
DATA BASE: FLIGHT TEST

AA1065_2
SA

Figure 7A-10. Cruise High Drag - Pressure Altitude Sea Level (Sheet 2 of 6)

CRUISE

PRESS ALT: 0 FT

CRUISE
0 FT
T701C (2)



-10°C

0°C

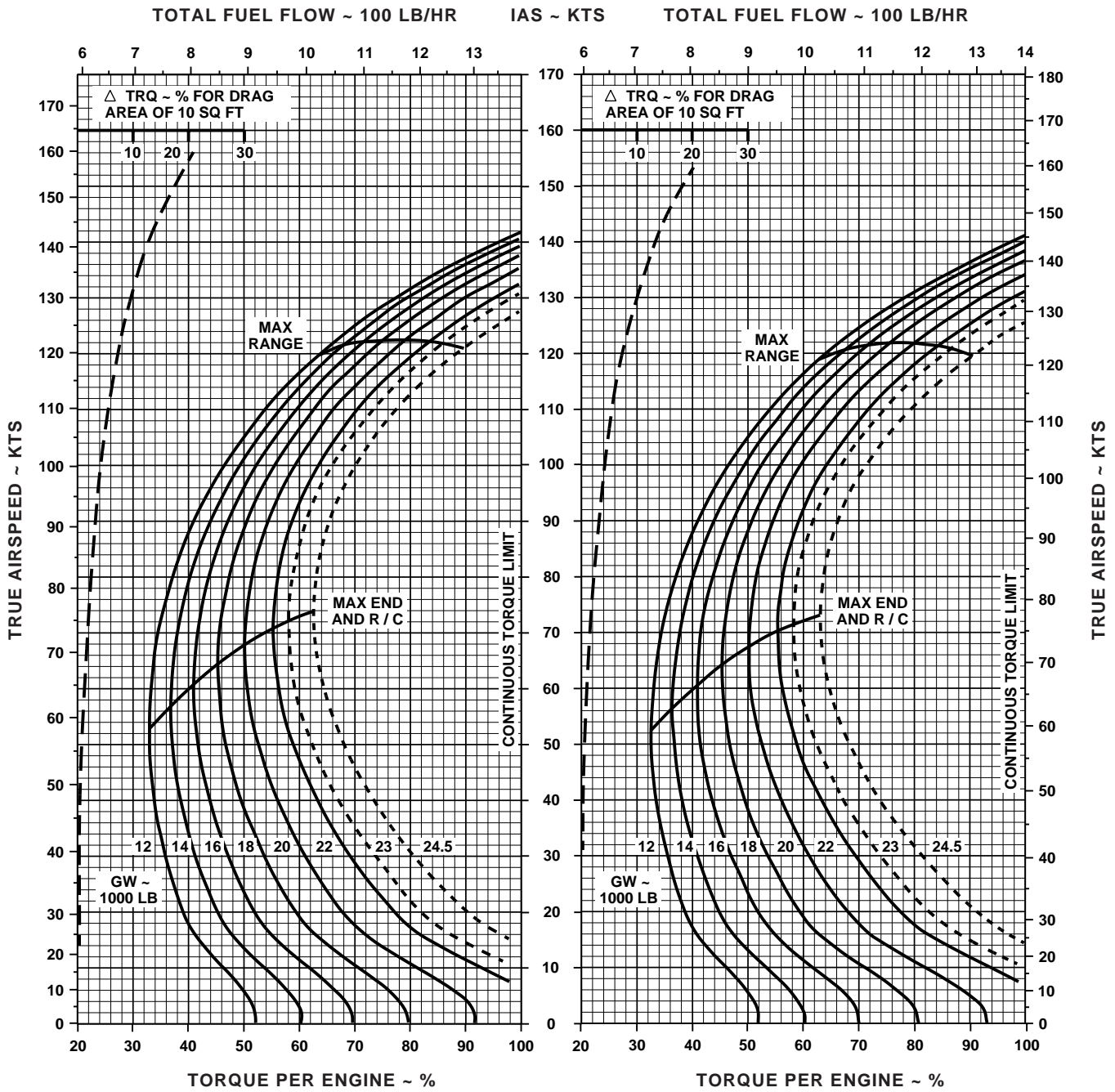

NOTE: SHORT DASH LINES: FERRY MISSION ONLY
DATA BASE: FLIGHT TEST

AA1065_3
SA

Figure 7A-10. Cruise High Drag - Pressure Altitude Sea Level (Sheet 3 of 6)

CRUISE

PRESS ALT: 0 FT

CRUISE
0 FT
T701C (2)



10°C

20°C

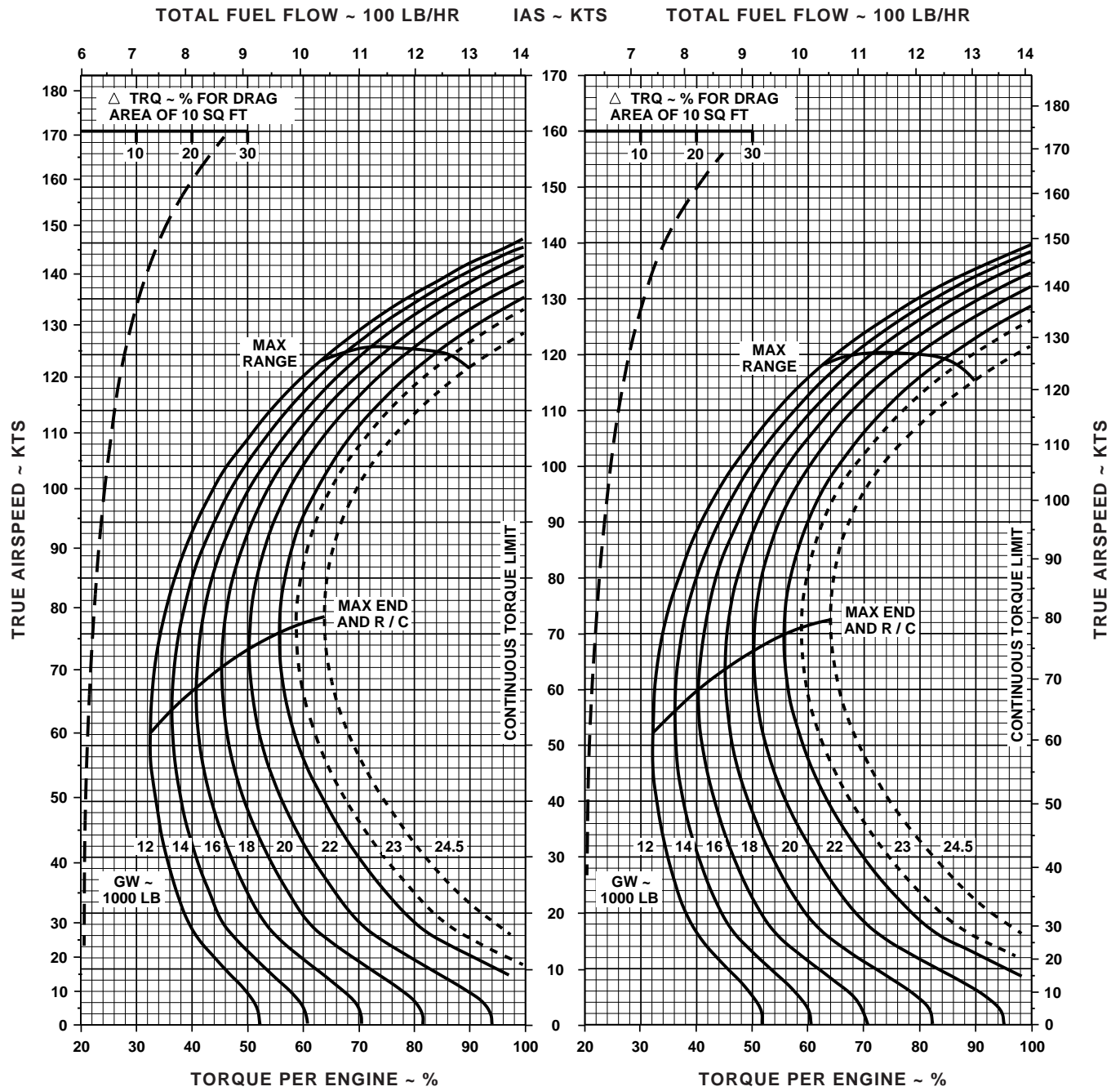

NOTE: SHORT DASH LINES: FERRY MISSION ONLY
DATA BASE: FLIGHT TEST

AA1065_4
SA

Figure 7A-10. Cruise High Drag - Pressure Altitude Sea Level (Sheet 4 of 6)

CRUISE

PRESS ALT: 0 FT

CRUISE
0 FT
T701C (2)



30°C

40°C

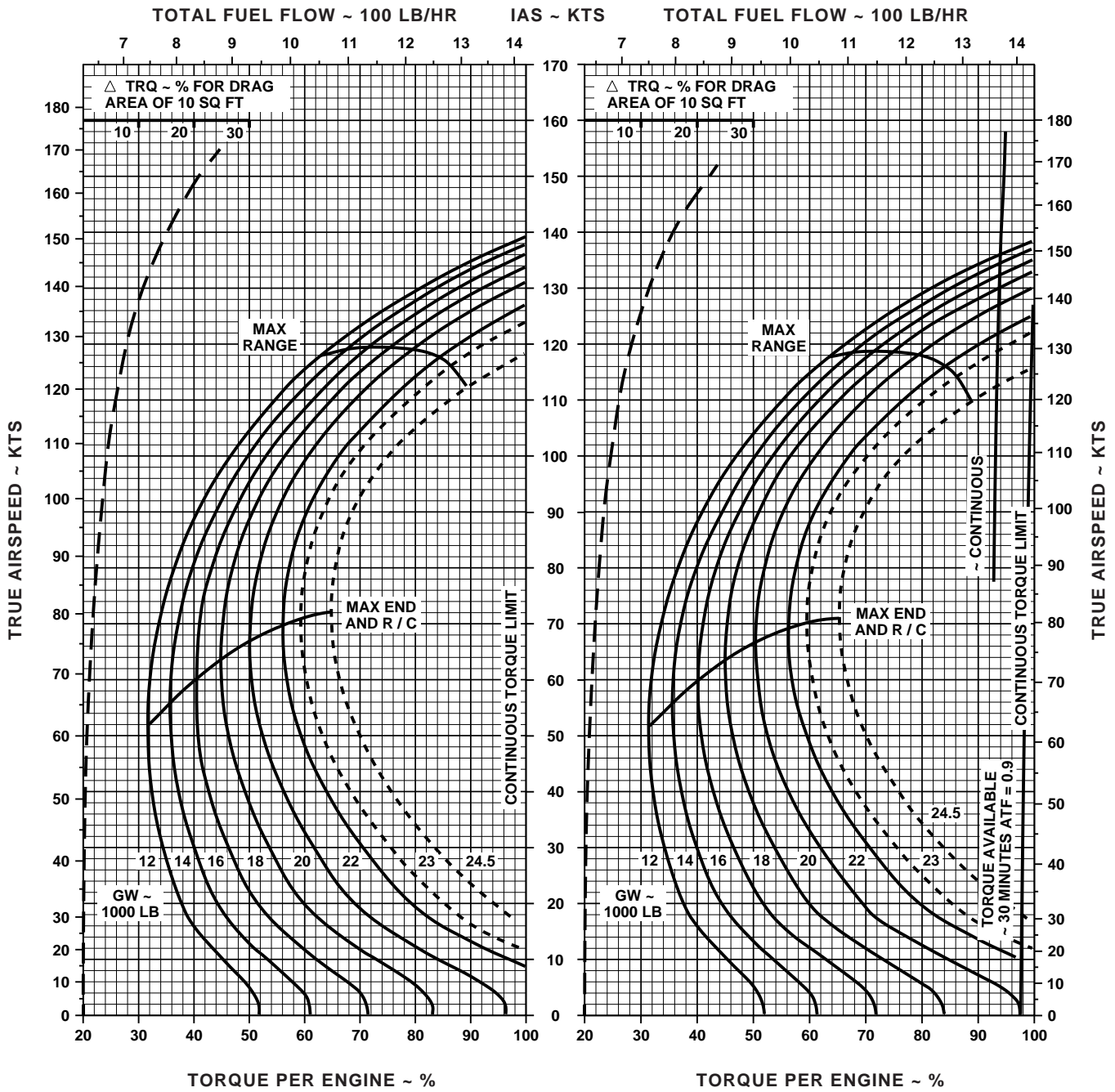

NOTE: SHORT DASH LINES: FERRY MISSION ONLY
DATA BASE: FLIGHT TEST

AA1065_5
SA

Figure 7A-10. Cruise High Drag - Pressure Altitude Sea Level (Sheet 5 of 6)

CRUISE

PRESS ALT: 0 FT

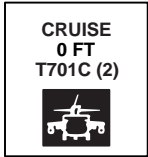

50°C

60°C

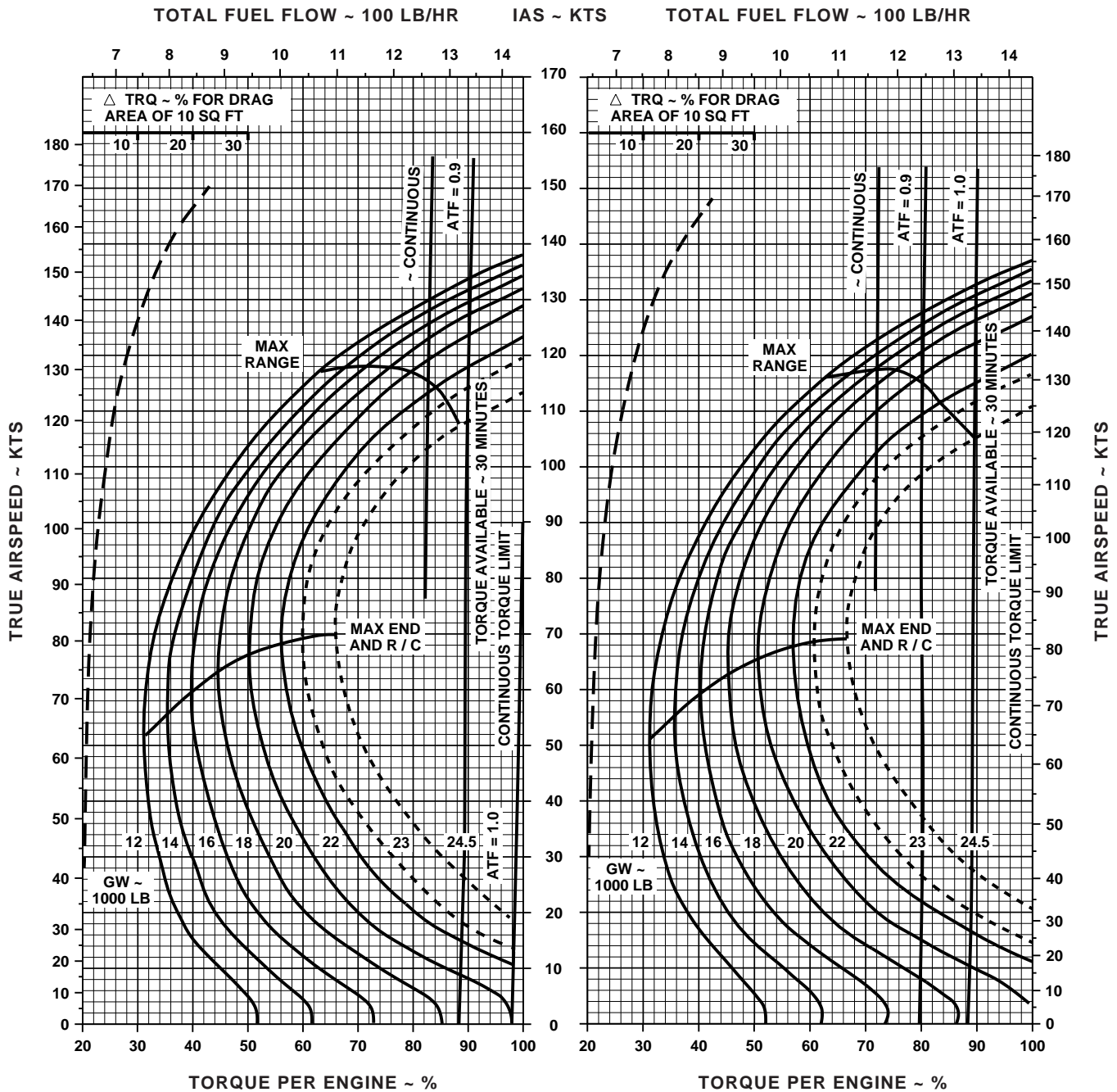

NOTE: SHORT DASH LINES: FERRY MISSION ONLY
 DATA BASE: FLIGHT TEST

AA1065_6 SA

Figure 7A-10. Cruise High Drag - Pressure Altitude Sea Level (Sheet 6 of 6)

CRUISE

CLEAN CONFIGURATION

PRESS ALT: 2,000 FT

CRUISE
2,000 FT
T701C (2)

-50°C

-40°C

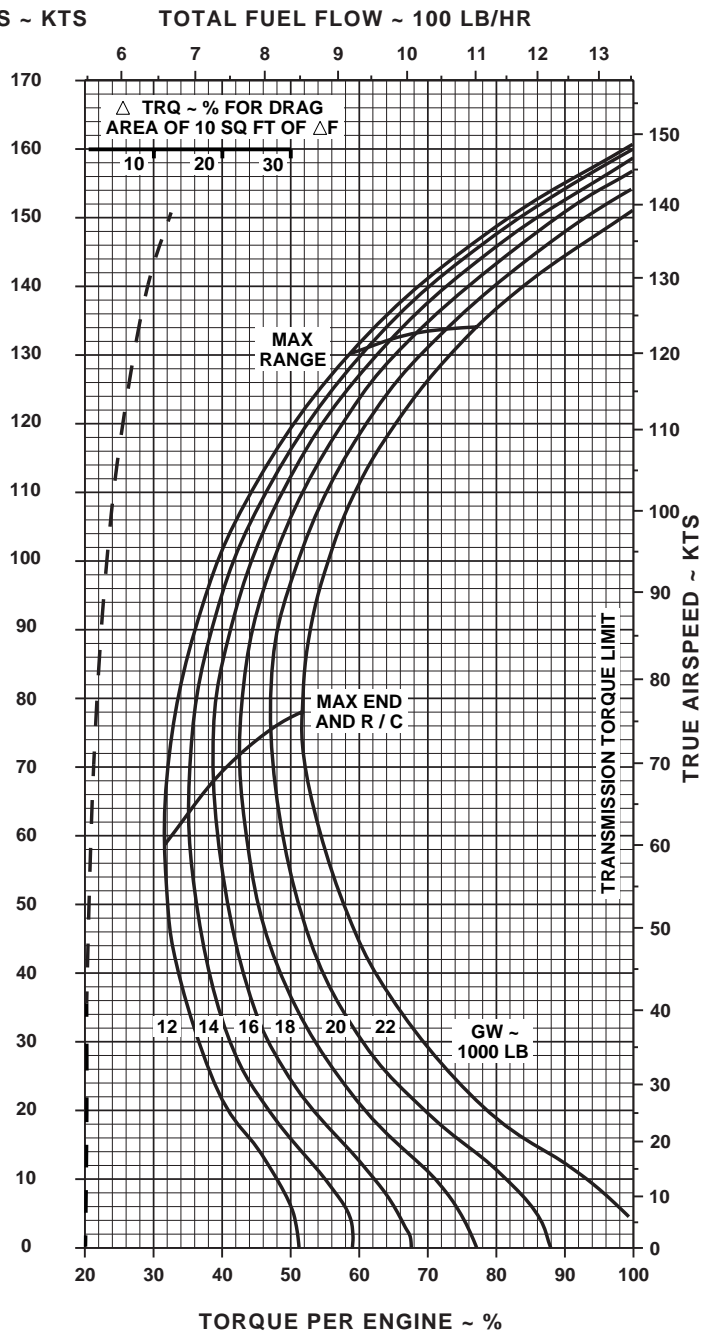
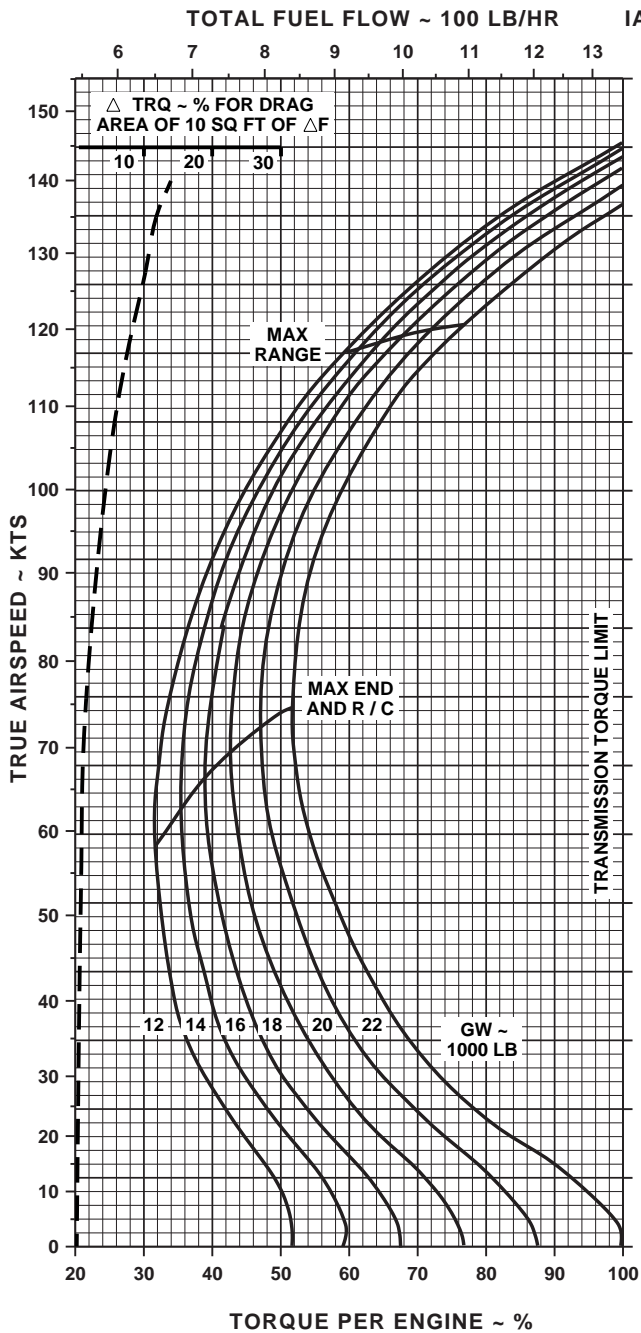

DATA BASE: FLIGHT TEST

AA1061_1
SA

Figure 7A-11. Cruise - Pressure Altitude 2,000 Feet (Sheet 1 of 6)

CRUISE

CLEAN CONFIGURATION

PRESS ALT: 2,000 FT

CRUISE
2,000 FT
T701C (2)

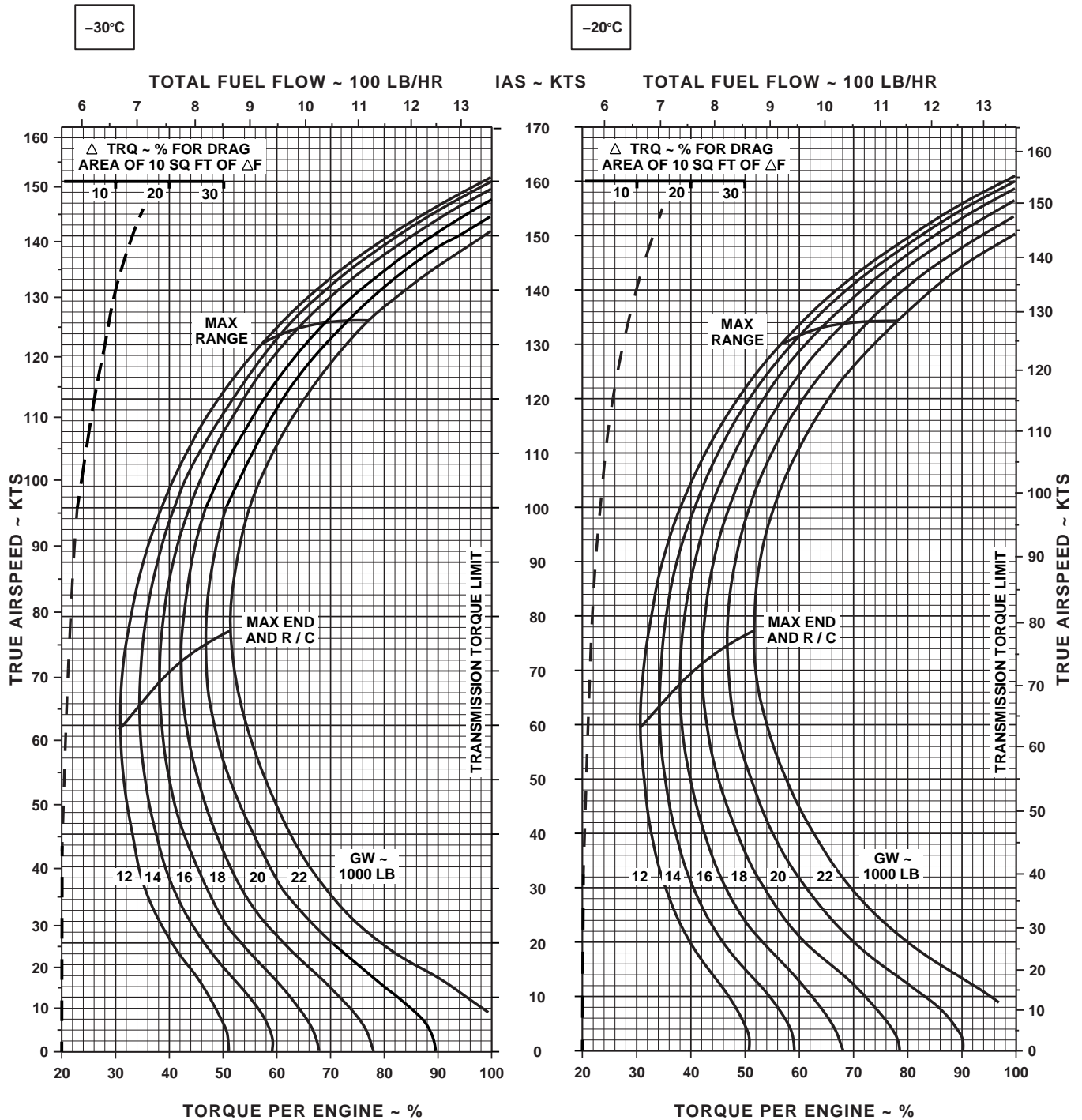

DATA BASE: FLIGHT TEST

AA1061_2
SA

Figure 7A-11. Cruise - Pressure Altitude 2,000 Feet (Sheet 2 of 6)

CRUISE

CLEAN CONFIGURATION

PRESS ALT: 2,000 FT

CRUISE
2,000 FT
T701C (2)

-10°C

0°C

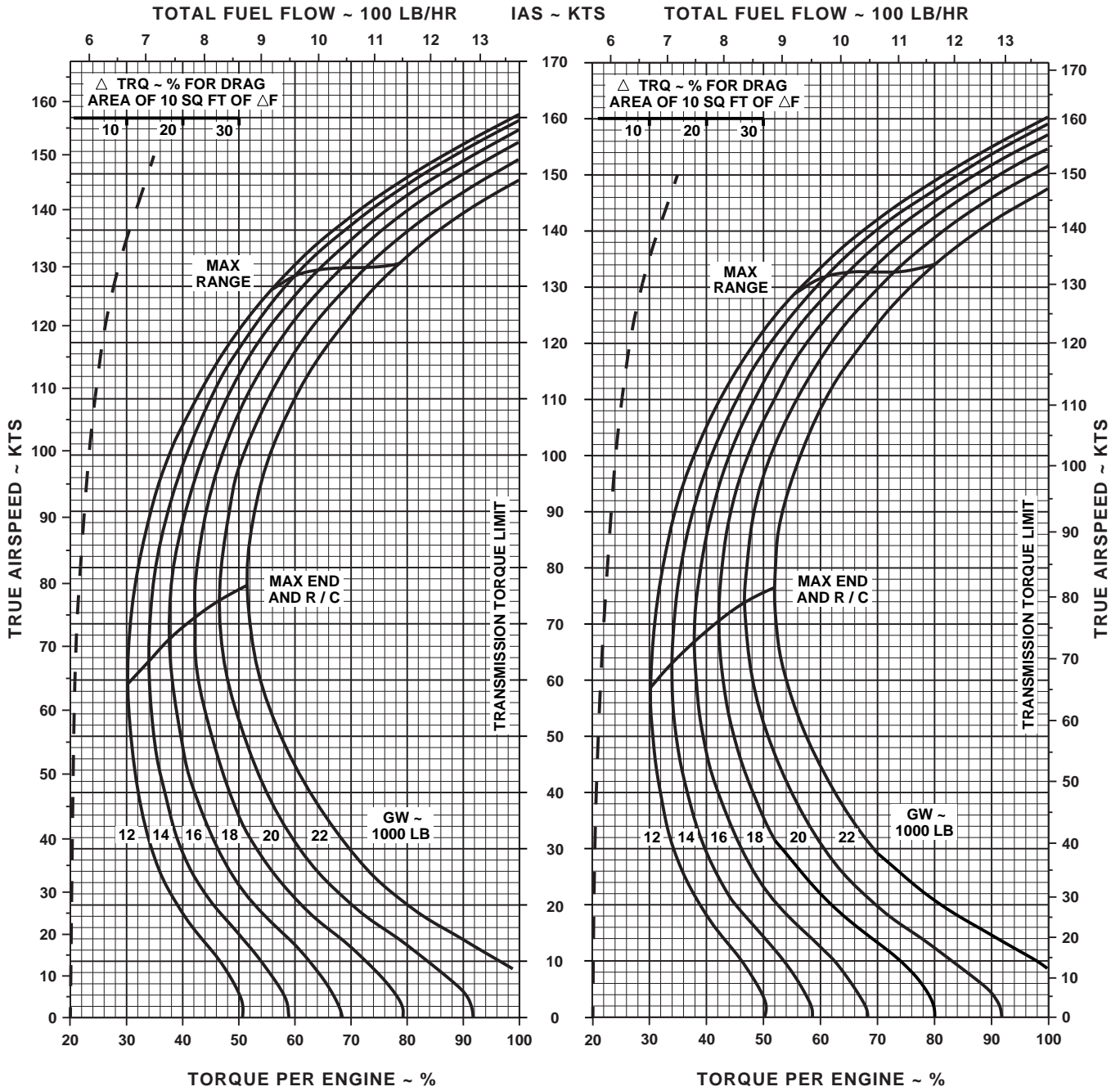

DATA BASE: FLIGHT TEST

AA1061_3
SA

Figure 7A-11. Cruise - Pressure Altitude 2,000 Feet (Sheet 3 of 6)

CRUISE

CLEAN CONFIGURATION

PRESS ALT: 2,000 FT

CRUISE
2,000 FT
T701C (2)

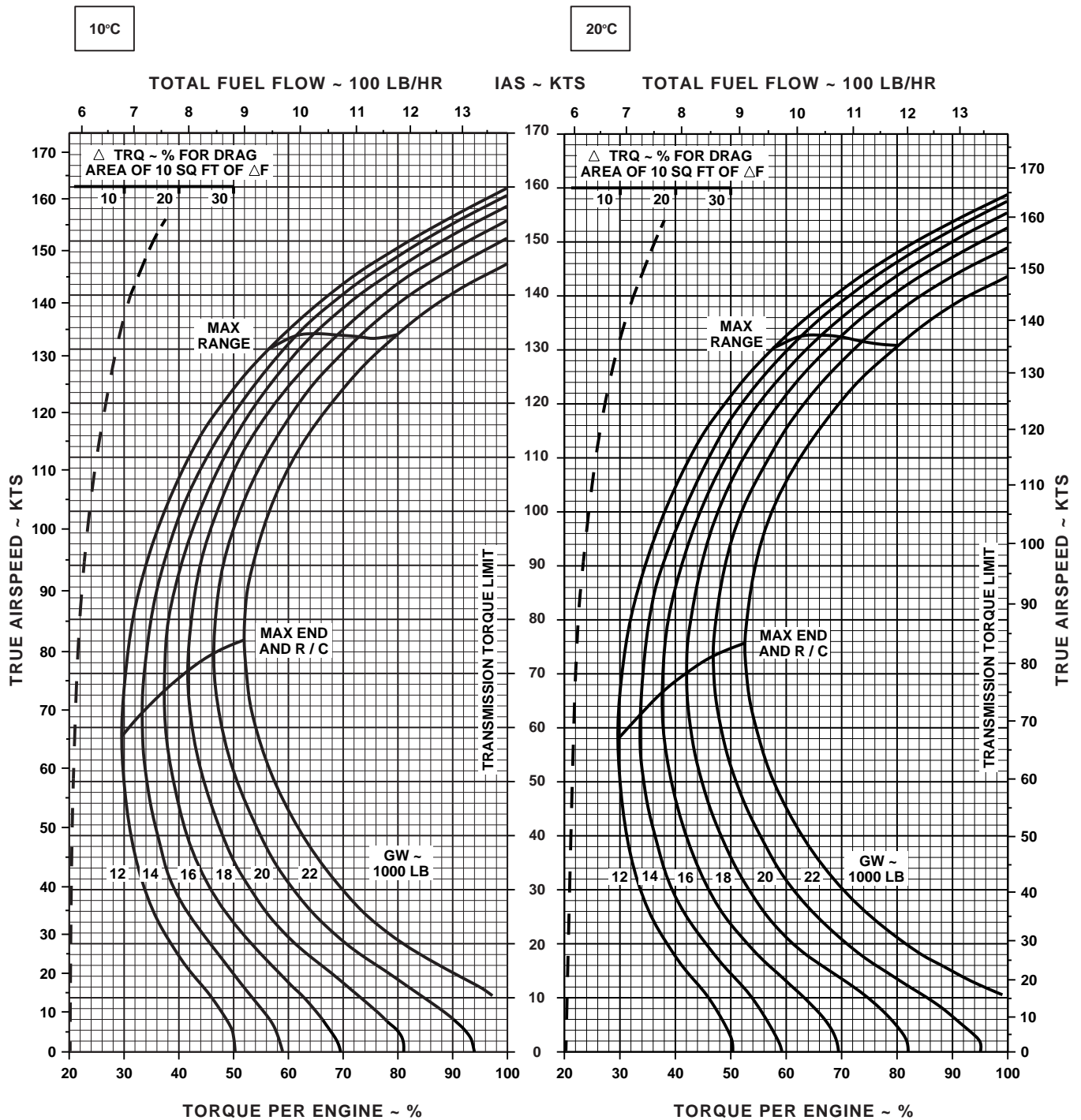

DATA BASE: FLIGHT TEST

AA1061_4
SA

Figure 7A-11. Cruise - Pressure Altitude 2,000 Feet (Sheet 4 of 6)

CRUISE

CLEAN CONFIGURATION

PRESS ALT: 2,000 FT

CRUISE
2,000 FT
T701C (2)

30°C

40°C

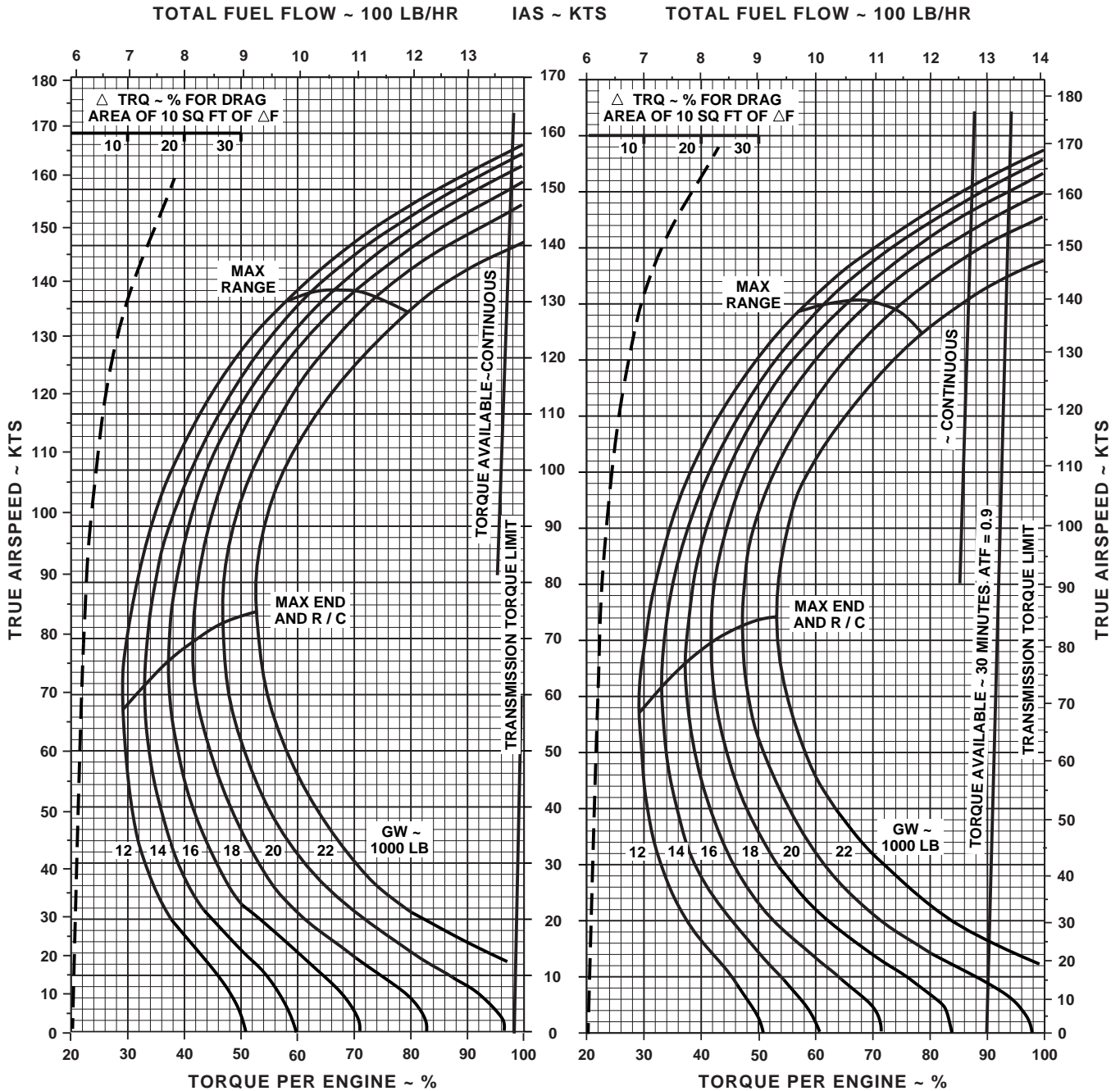

DATA BASE: FLIGHT TEST

AA1061_5
SA

Figure 7A-11. Cruise - Pressure Altitude 2,000 Feet (Sheet 5 of 6)

CRUISE

CLEAN CONFIGURATION

PRESS ALT: 2,000 FT

CRUISE
2,000 FT
T701C (2)

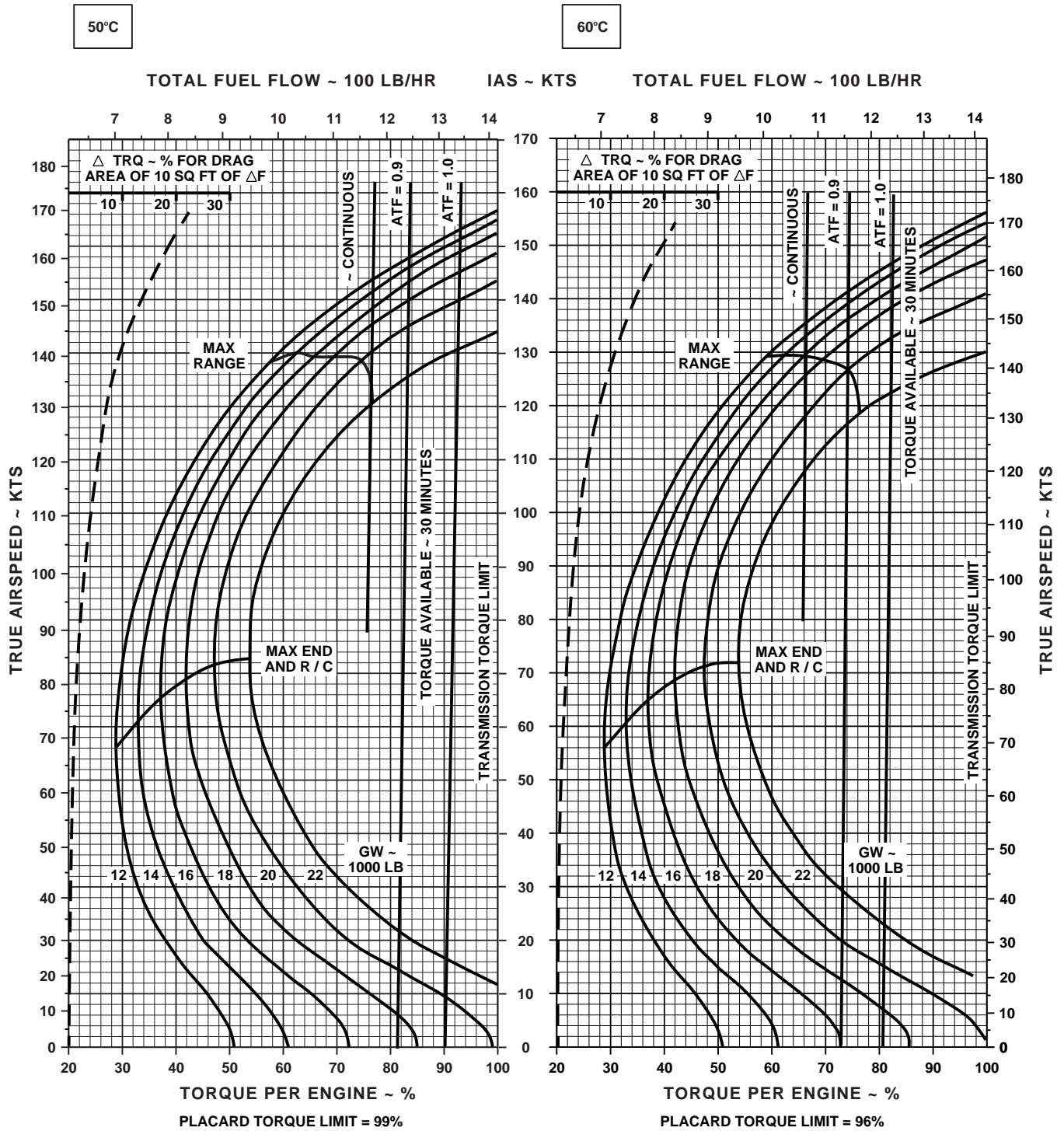

DATA BASE: FLIGHT TEST

AA1061_6
SA

Figure 7A-11. Cruise - Pressure Altitude 2,000 Feet (Sheet 6 of 6)

CRUISE

PRESS ALT: 2000 FT

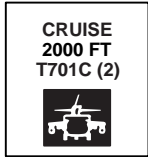

-50°C

-40°C

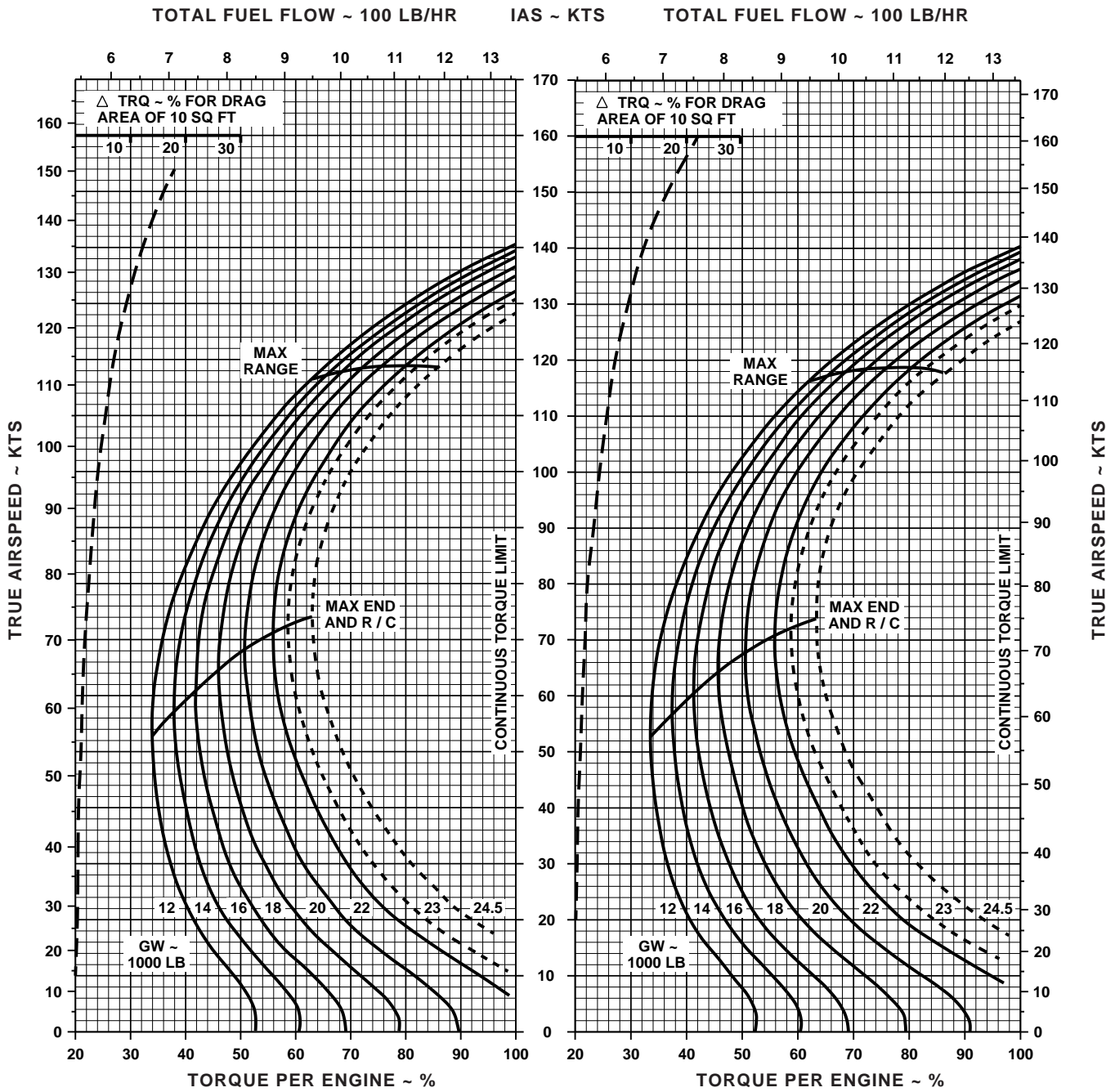

NOTE: SHORT DASH LINES: FERRY MISSION ONLY
 DATA BASE: FLIGHT TEST

AA1062_1
 SA

Figure 7A-12. Cruise High Drag - Pressure Altitude 2,000 Feet (Sheet 1 of 6)

CRUISE

PRESS ALT: 2000 FT

CRUISE
2000 FT
T701C (2)



-30°C

-20°C

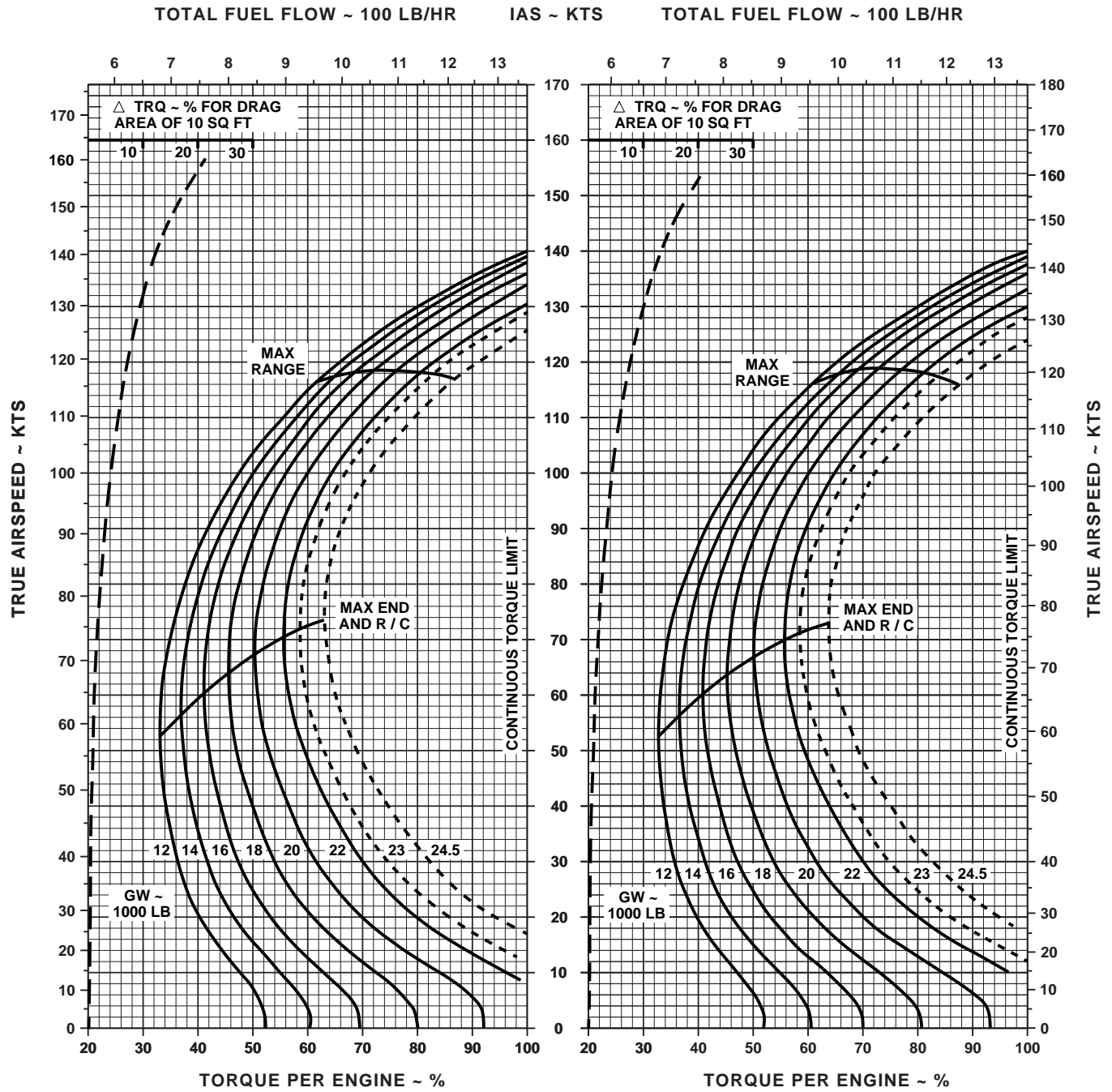

NOTE: SHORT DASH LINES: FERRY MISSION ONLY
DATA BASE: FLIGHT TEST

AA1062_2
SA

Figure 7A-12. Cruise High Drag - Pressure Altitude 2,000 Feet (Sheet 2 of 6)

CRUISE

PRESS ALT: 2000 FT

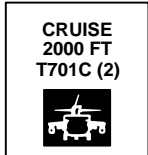

-10°C

0°C

TOTAL FUEL FLOW ~ 100 LB/HR

IAS ~ KTS

TOTAL FUEL FLOW ~ 100 LB/HR

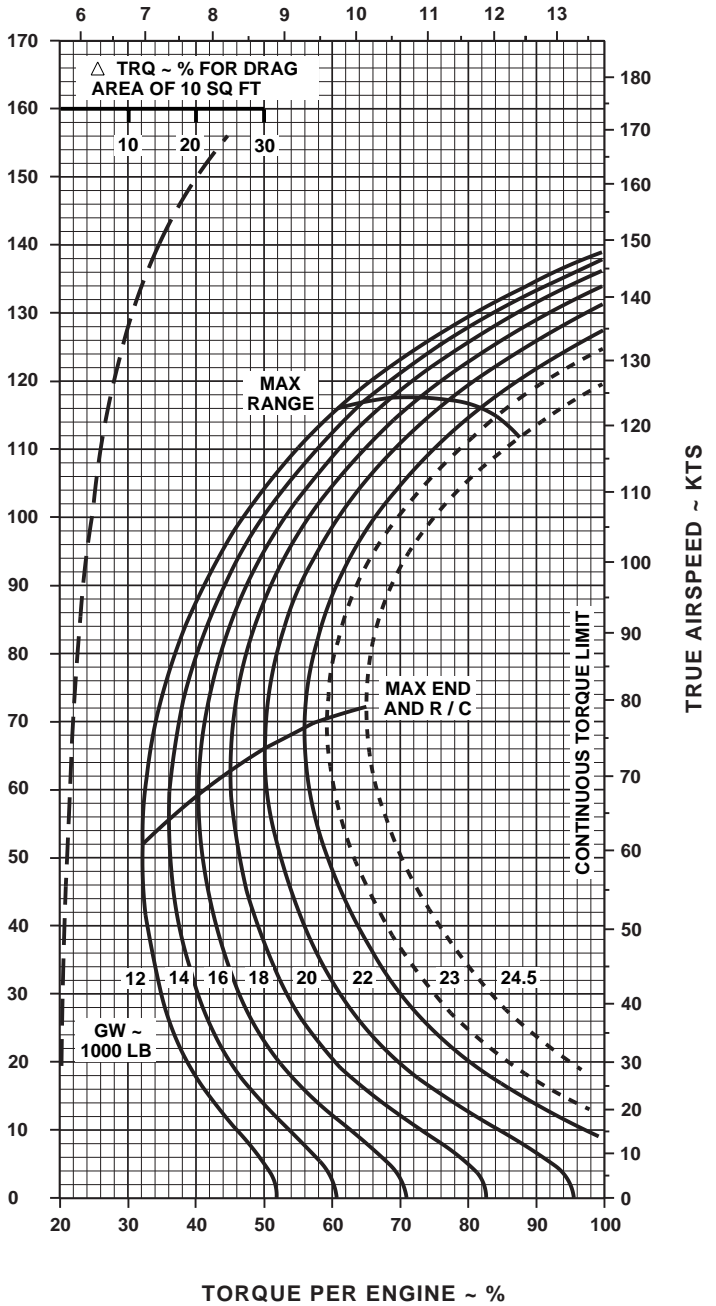
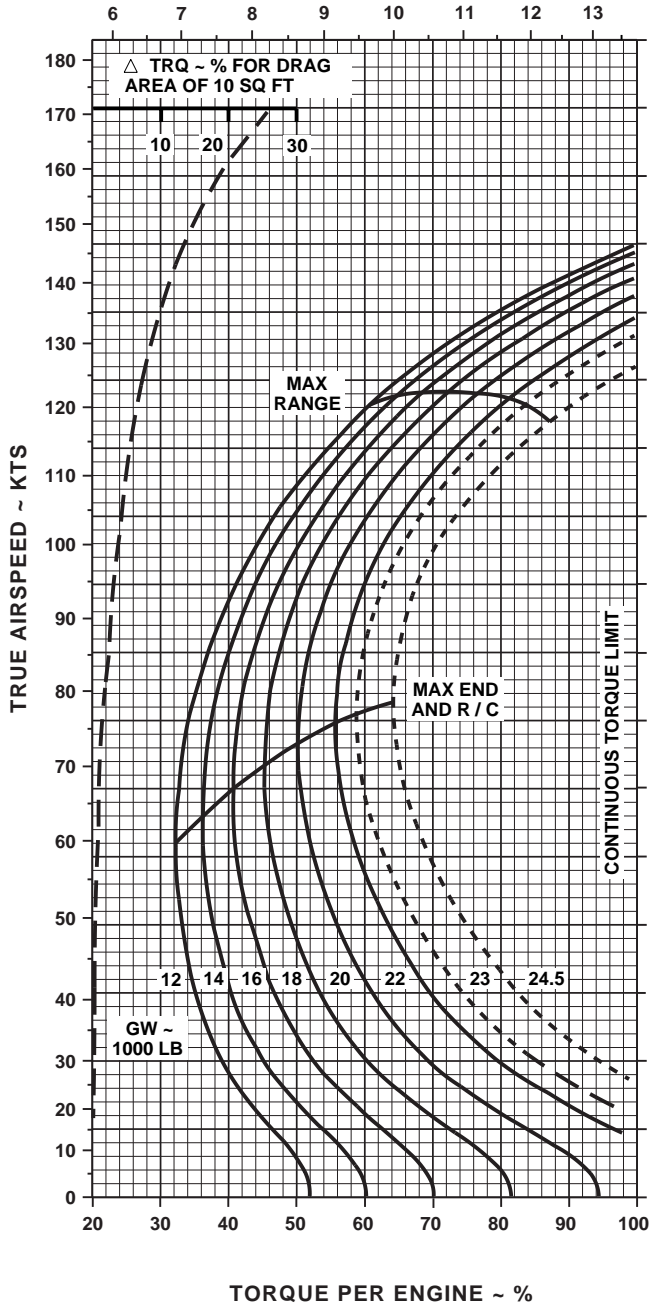

NOTE: SHORT DASH LINES: FERRY MISSION ONLY
 DATA BASE: FLIGHT TEST

AA1062_3
 SA

Figure 7A-12. Cruise High Drag - Pressure Altitude 2,000 Feet (Sheet 3 of 6)

CRUISE

PRESS ALT: 2000 FT

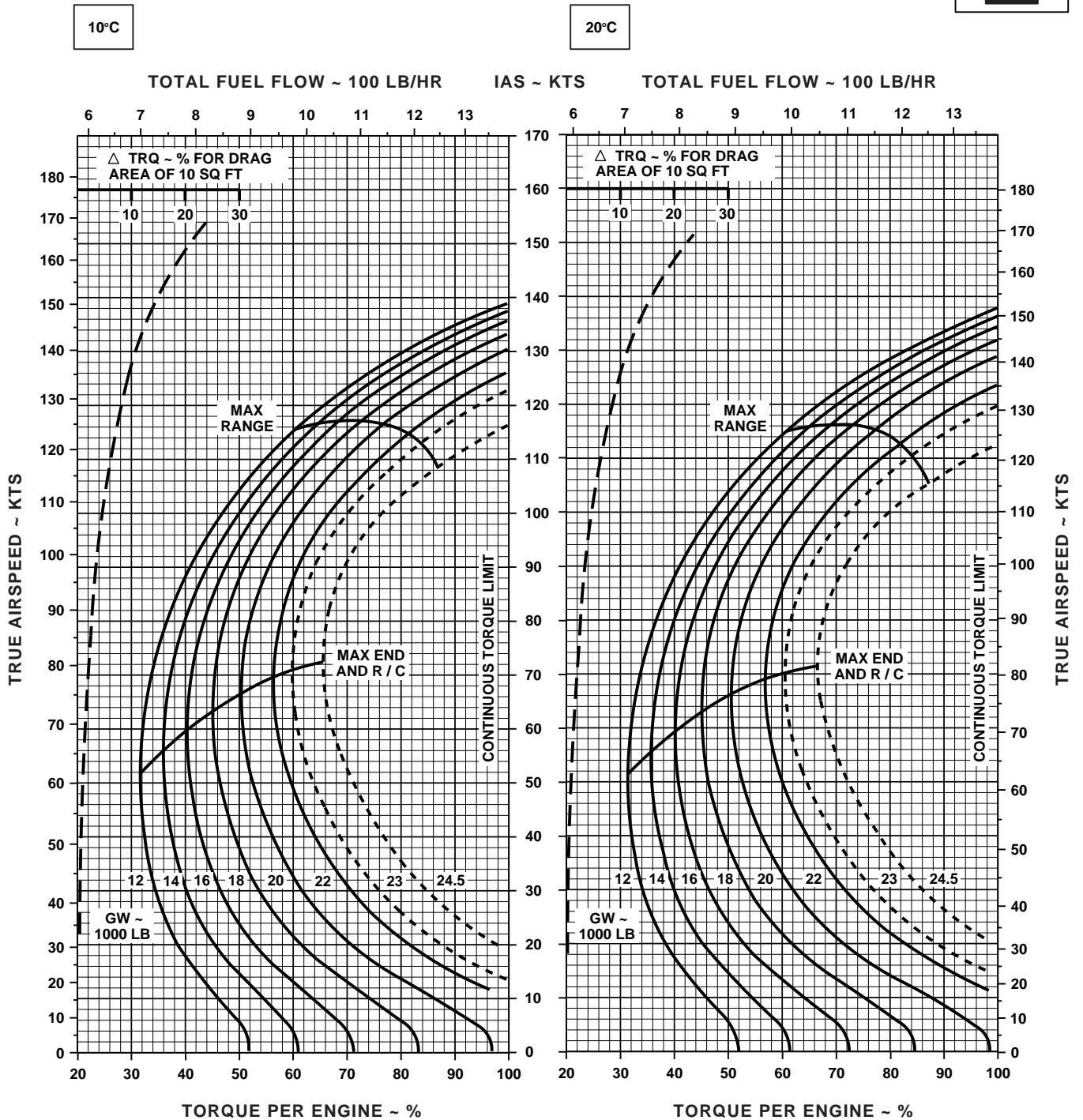

NOTE: SHORT DASH LINES: FERRY MISSION ONLY
 DATA BASE: FLIGHT TEST

AA1062_4
 SA

Figure 7A-12. Cruise High Drag - Pressure Altitude 2,000 Feet (Sheet 4 of 6)

CRUISE

PRESS ALT: 2000 FT

CRUISE
2000 FT
T701C (2)



30°C

40°C

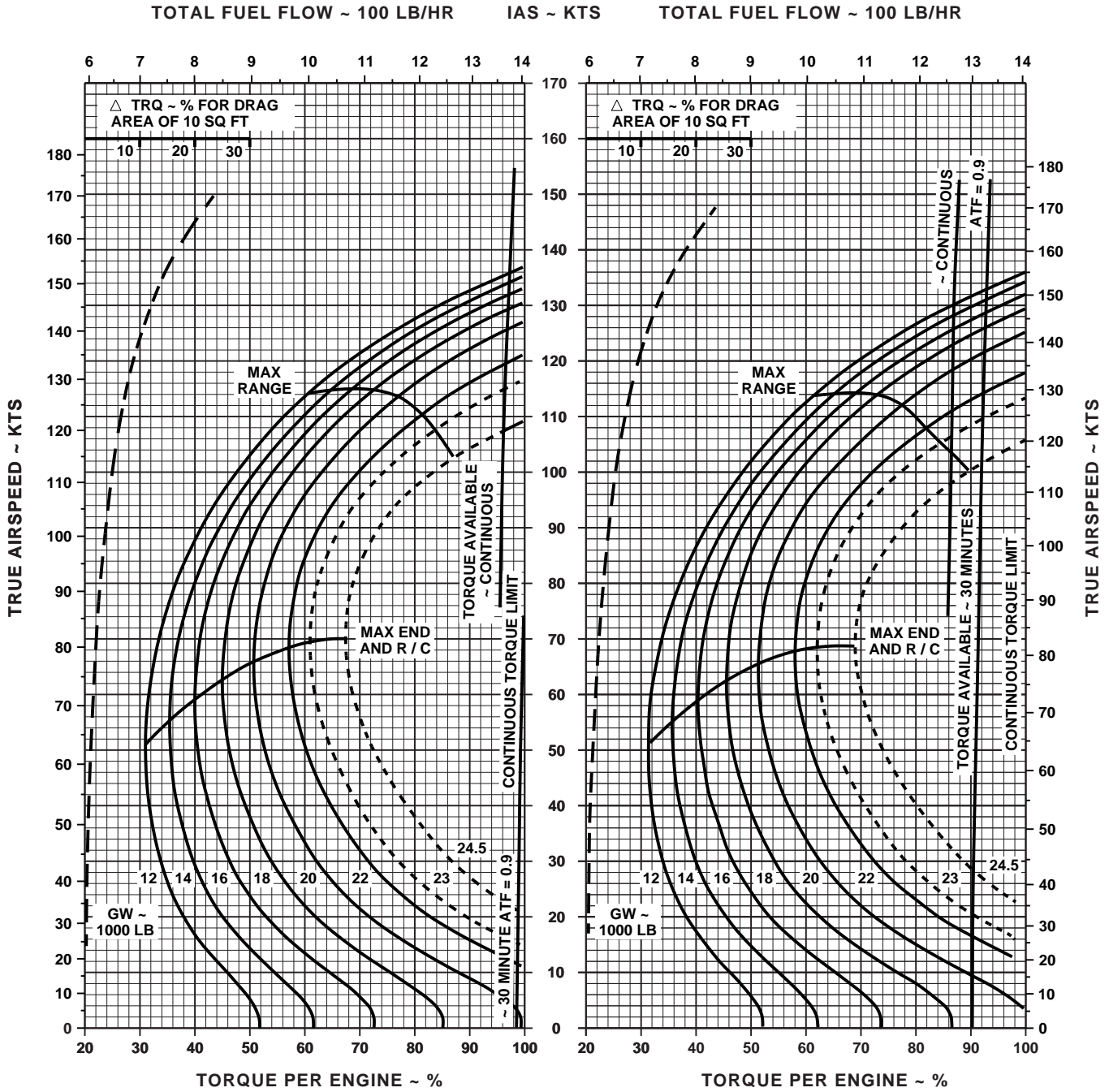

NOTE: SHORT DASH LINES: FERRY MISSION ONLY
DATA BASE: FLIGHT TEST

AA1062_5
SA

Figure 7A-12. Cruise High Drag - Pressure Altitude 2,000 Feet (Sheet 5 of 6)

CRUISE

PRESS ALT: 2000 FT

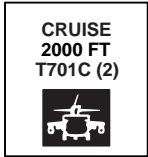

50°C

60°C

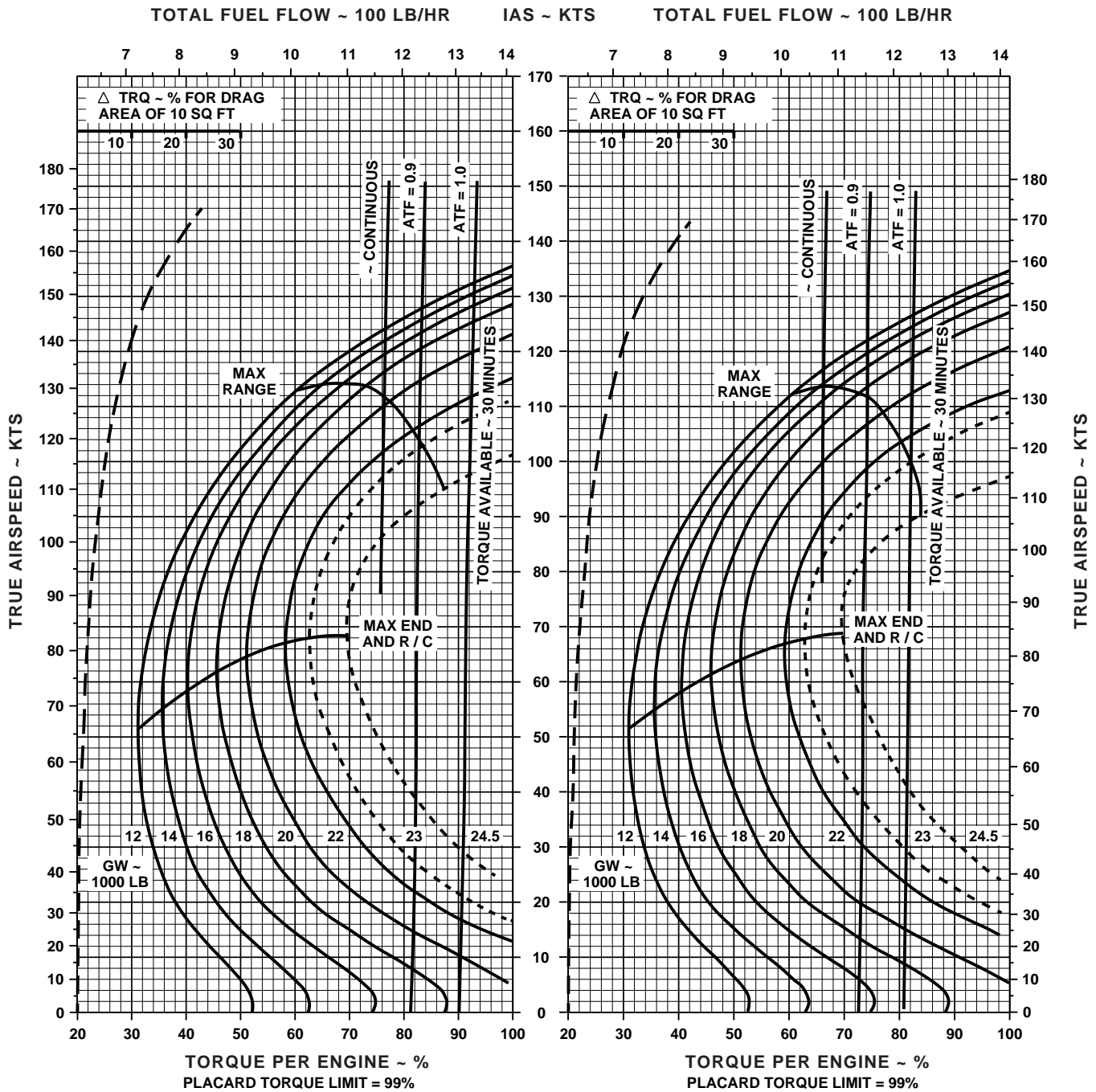

NOTE: SHORT DASH LINES: FERRY MISSION ONLY
 DATA BASE: FLIGHT TEST

AA1062_6 SA

Figure 7A-12. Cruise High Drag - Pressure Altitude 2,000 Feet (Sheet 6 of 6)

CRUISE

CLEAN CONFIGURATION

PRESS ALT: 4,000 FT

CRUISE
4,000 FT
T701C (2)

-50°C

-40°C

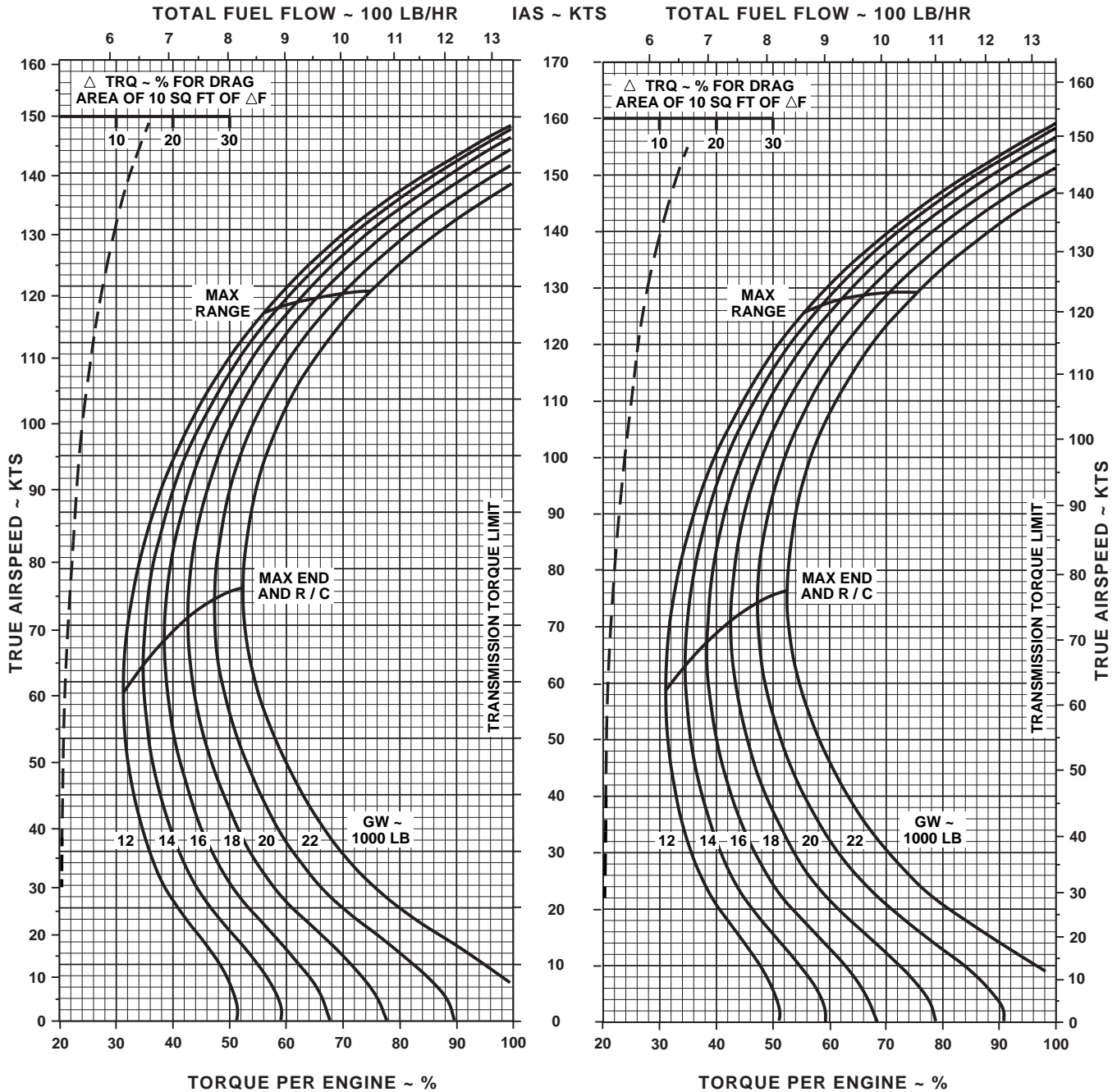

DATA BASE: FLIGHT TEST

AA1063_1
SA

Figure 7A-13. Cruise - Pressure Altitude 4,000 Feet (Sheet 1 of 6)

CRUISE

CLEAN CONFIGURATION

PRESS ALT: 4,000 FT

CRUISE
4,000 FT
T701C (2)

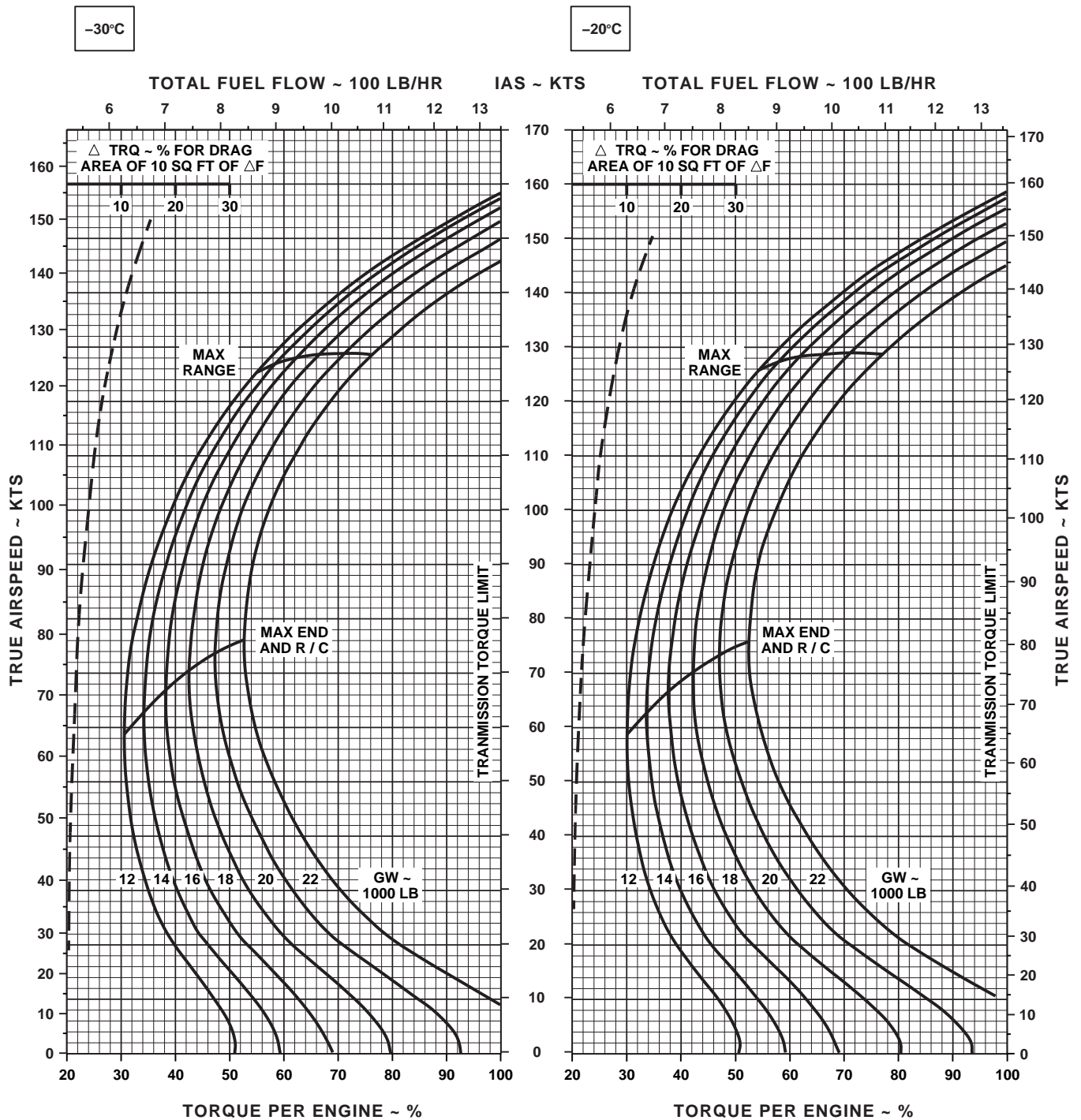

DATA BASE: FLIGHT TEST

AA1063_2
SA

Figure 7A-13. Cruise - Pressure Altitude 4,000 Feet (Sheet 2 of 6)

CRUISE

CLEAN CONFIGURATION

PRESS ALT: 4,000 FT

CRUISE
4,000 FT
T701C (2)

-10°C

0°C

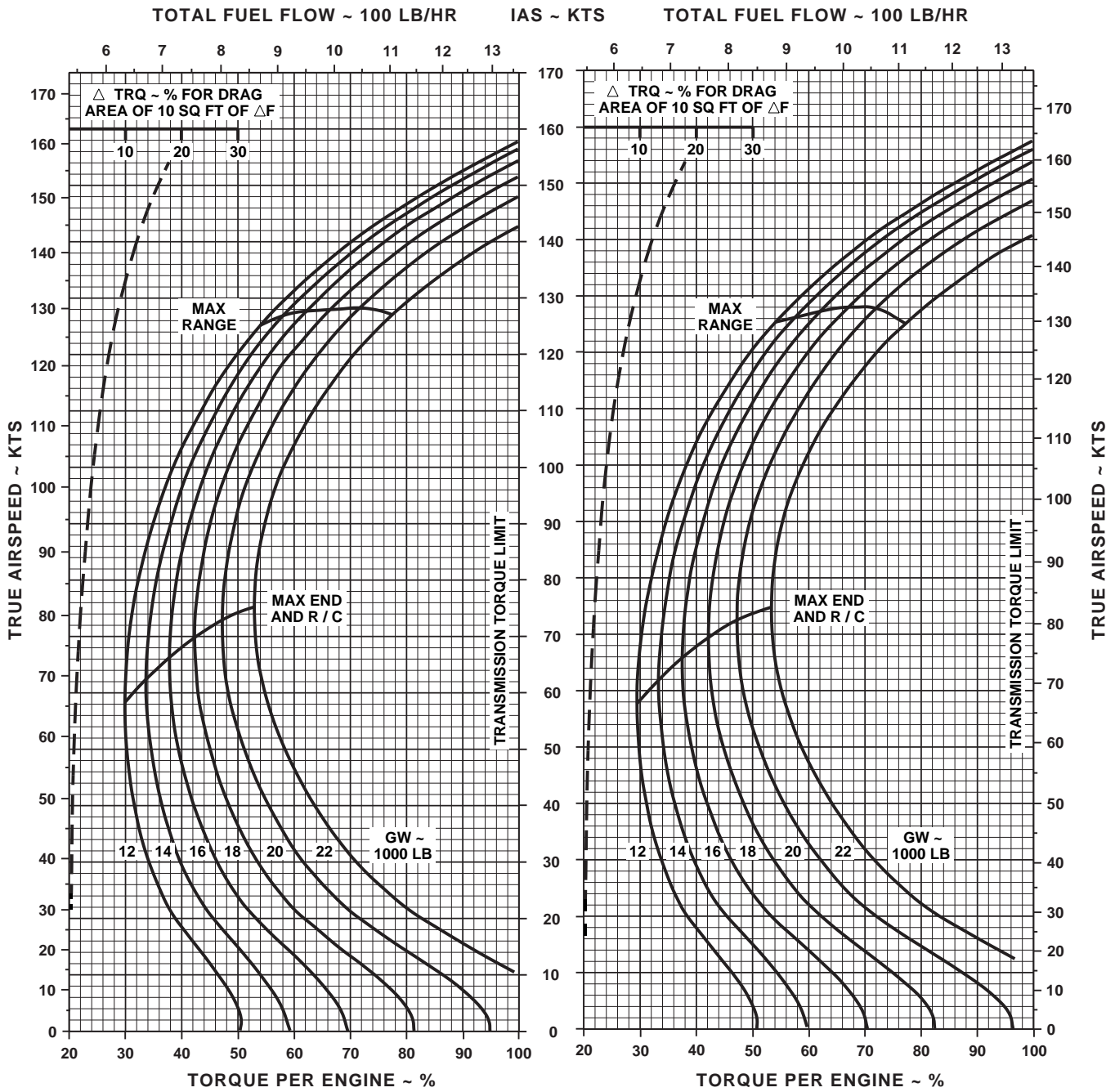

DATA BASE: FLIGHT TEST

AA1063_3
SA

Figure 7A-13. Cruise - Pressure Altitude 4,000 Feet (Sheet 3 of 6)

CRUISE

CLEAN CONFIGURATION

PRESS ALT: 4,000 FT

CRUISE
4,000 FT
T701C (2)

30°C

40°C

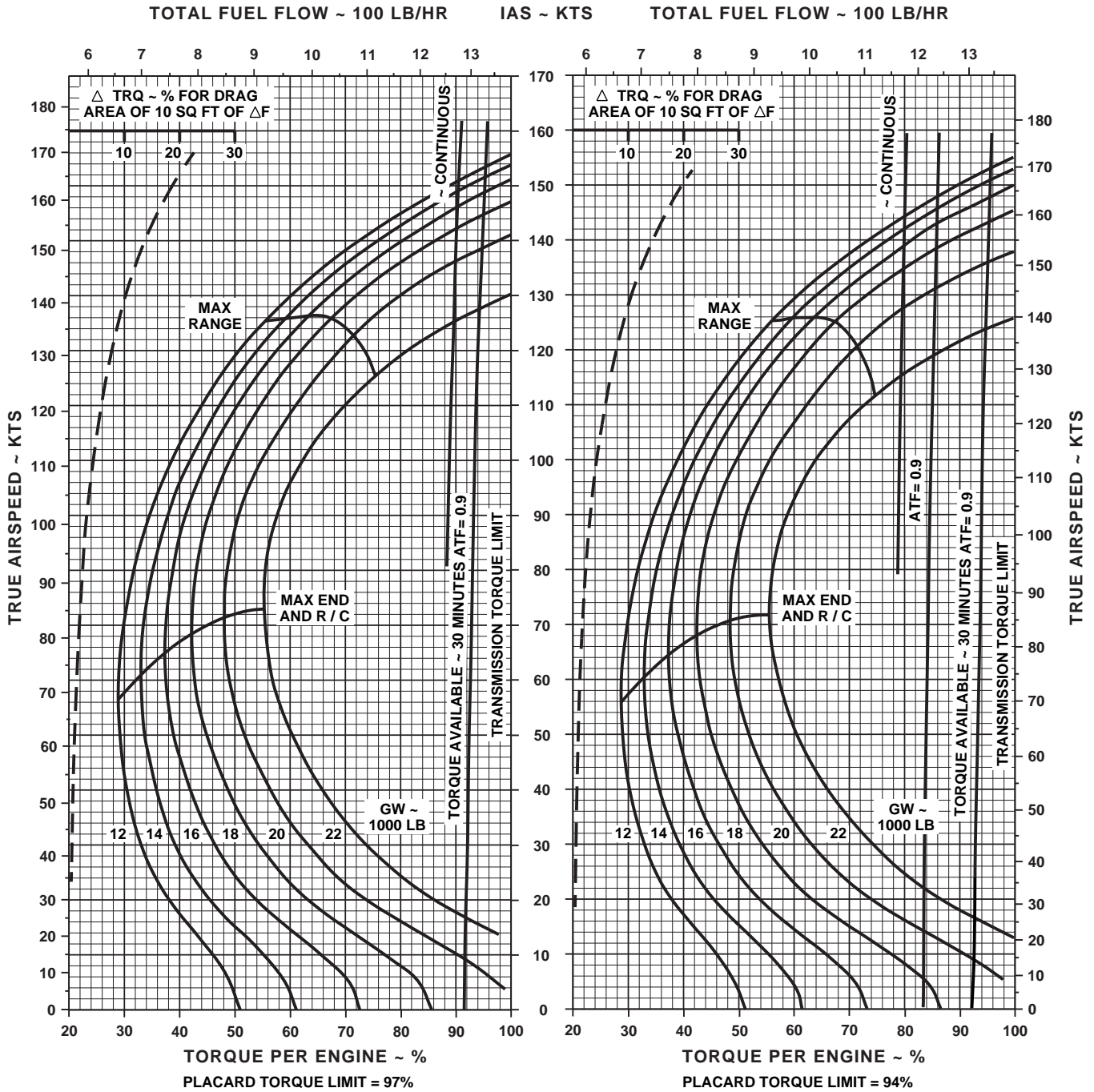

DATA BASE: FLIGHT TEST

AA1063_5
SA

Figure 7A-13. Cruise - Pressure Altitude 4,000 Feet (Sheet 5 of 6)

CRUISE

CLEAN CONFIGURATION

PRESS ALT: 4,000 FT

CRUISE
4,000 FT
T701C (2)

50°C

60°C

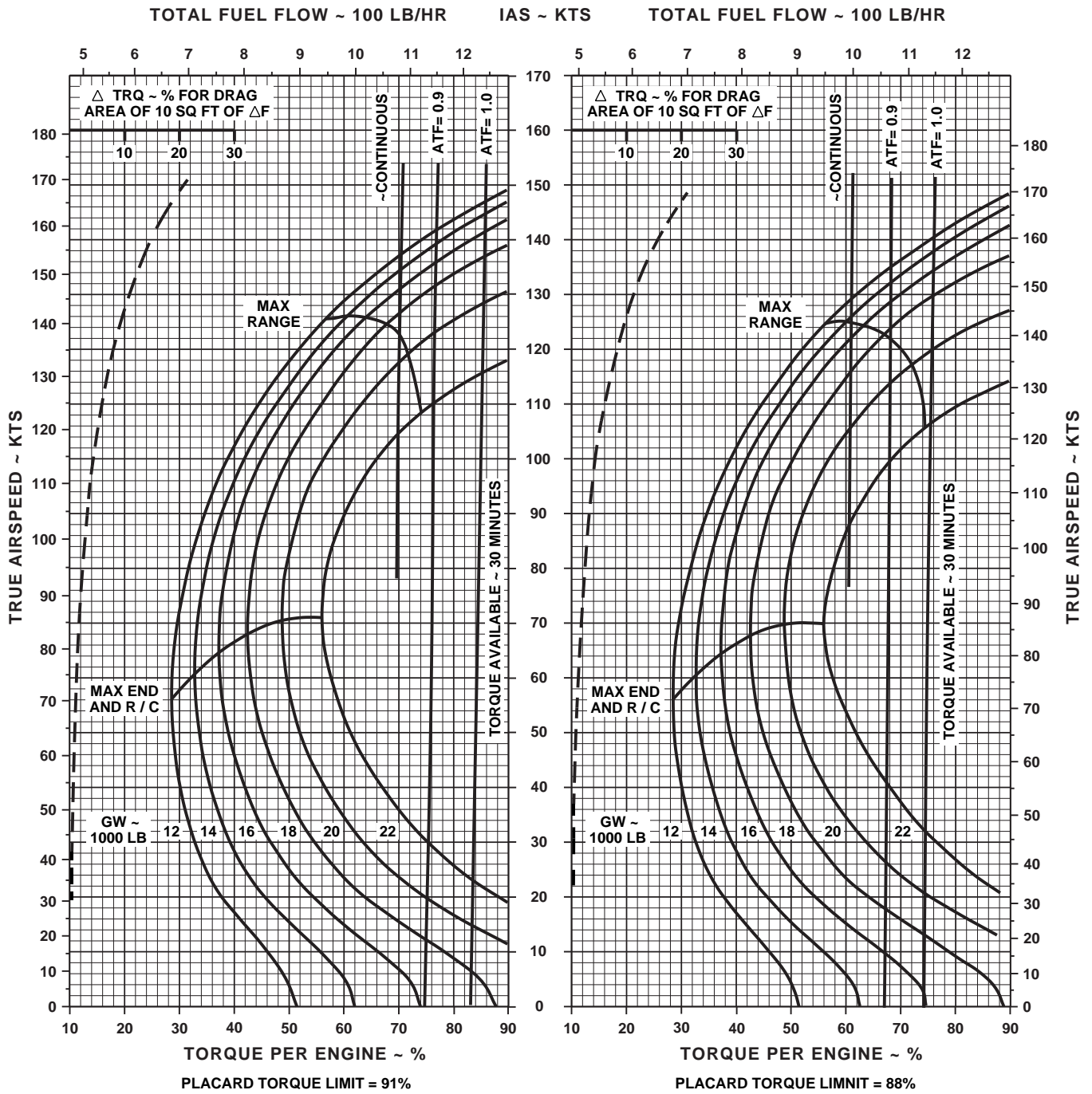

DATA BASE: FLIGHT TEST

AA1063_6
SA

Figure 7A-13. Cruise - Pressure Altitude 4,000 Feet (Sheet 6 of 6)

CRUISE

PRESS ALT: 4000 FT

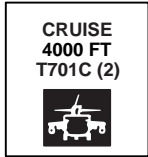

-50°C

-40°C

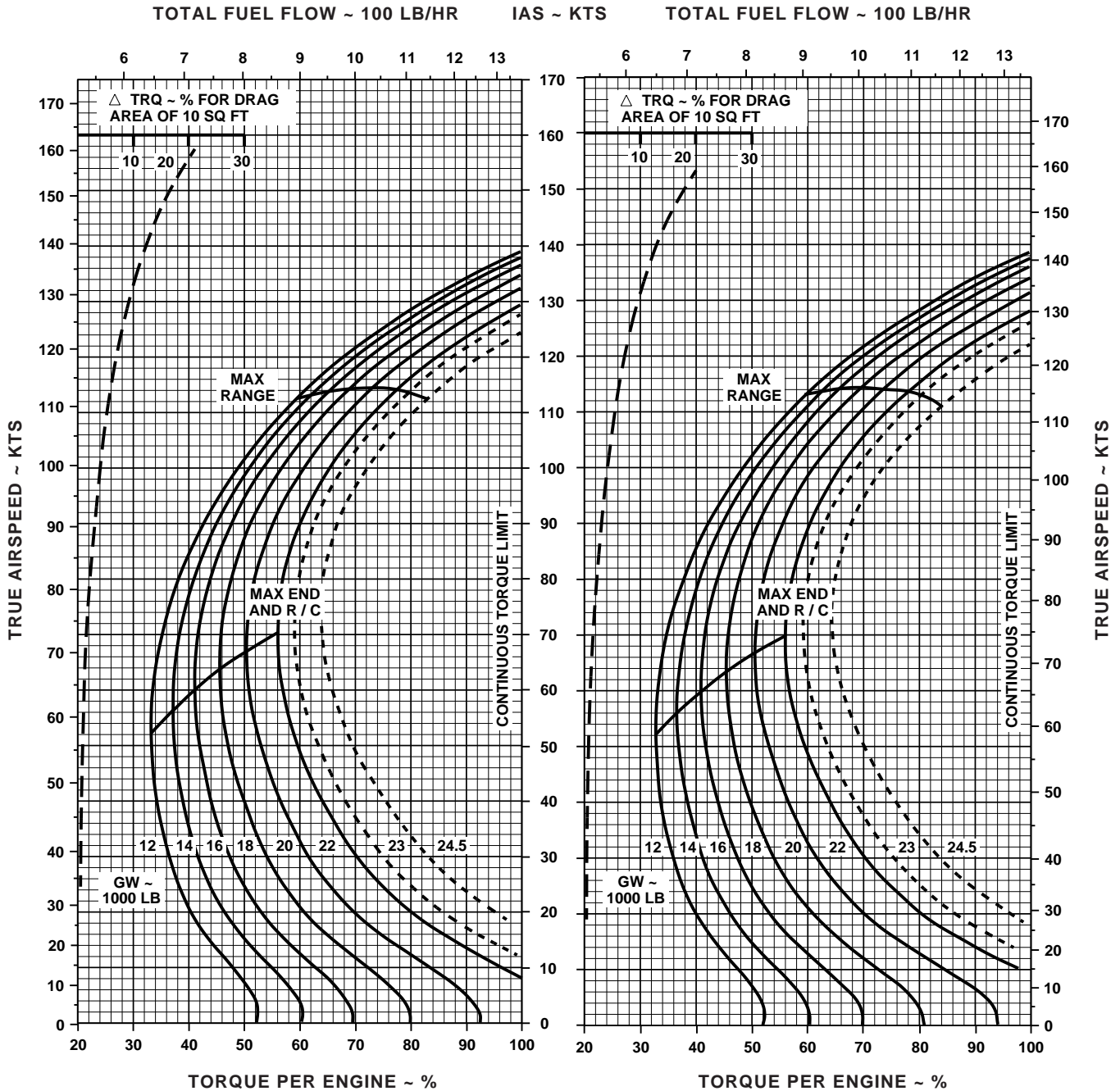

NOTE: SHORT DASH LINES: FERRY MISSION ONLY
 DATA BASE: FLIGHT TEST

AA1064_1
 SA

Figure 7A-14. Cruise High Drag - Pressure Altitude 4,000 Feet (Sheet 1 of 6)

CRUISE

PRESS ALT: 4000 FT



-30°C

-20°C

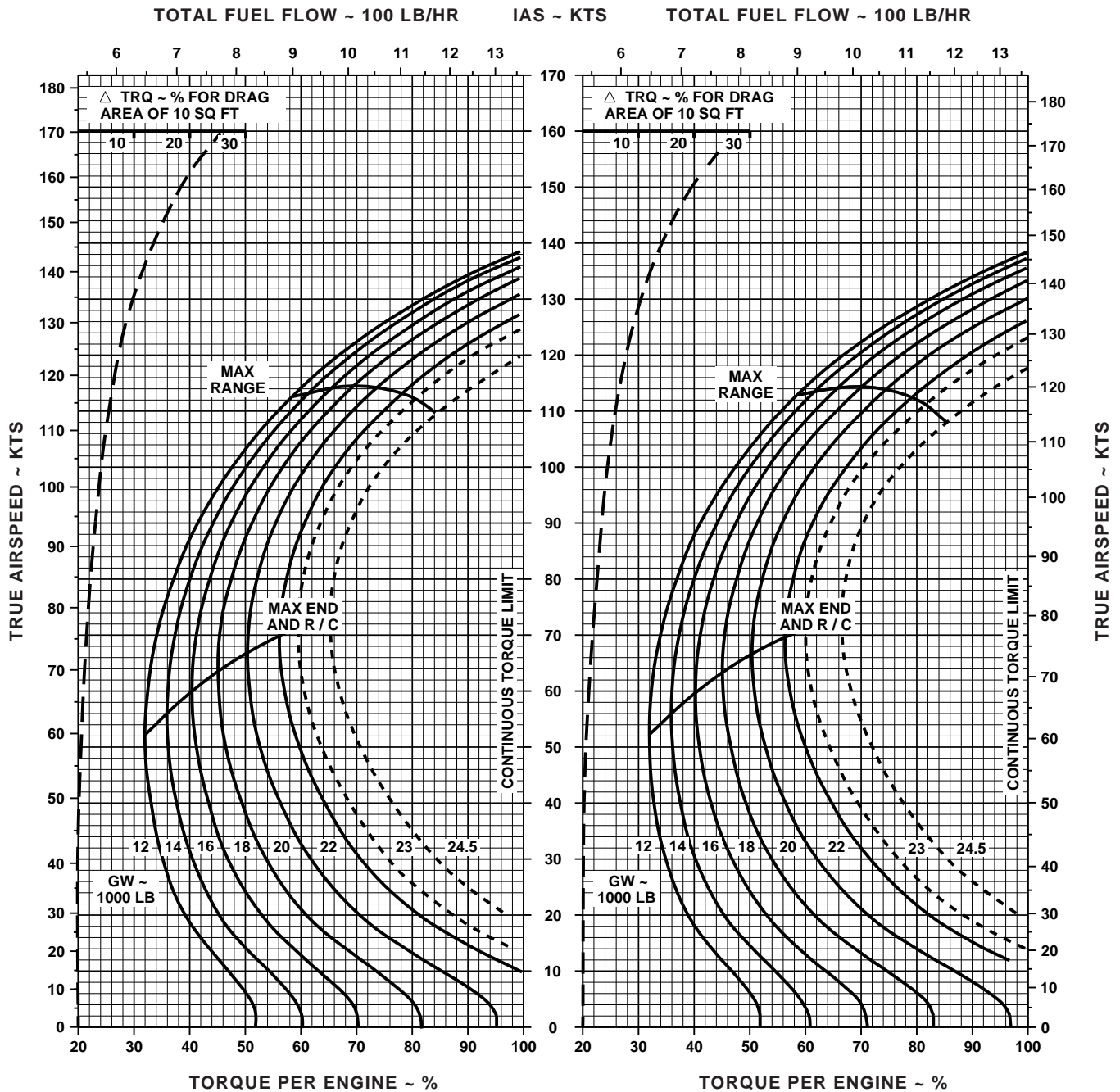

NOTE: SHORT DASH LINES: FERRY MISSION ONLY
 DATA BASE: FLIGHT TEST

AA1064_2
 SA

Figure 7A-14. Cruise High Drag - Pressure Altitude 4,000 Feet (Sheet 2 of 6)

CRUISE

PRESS ALT: 4000 FT



-10°C

0°C

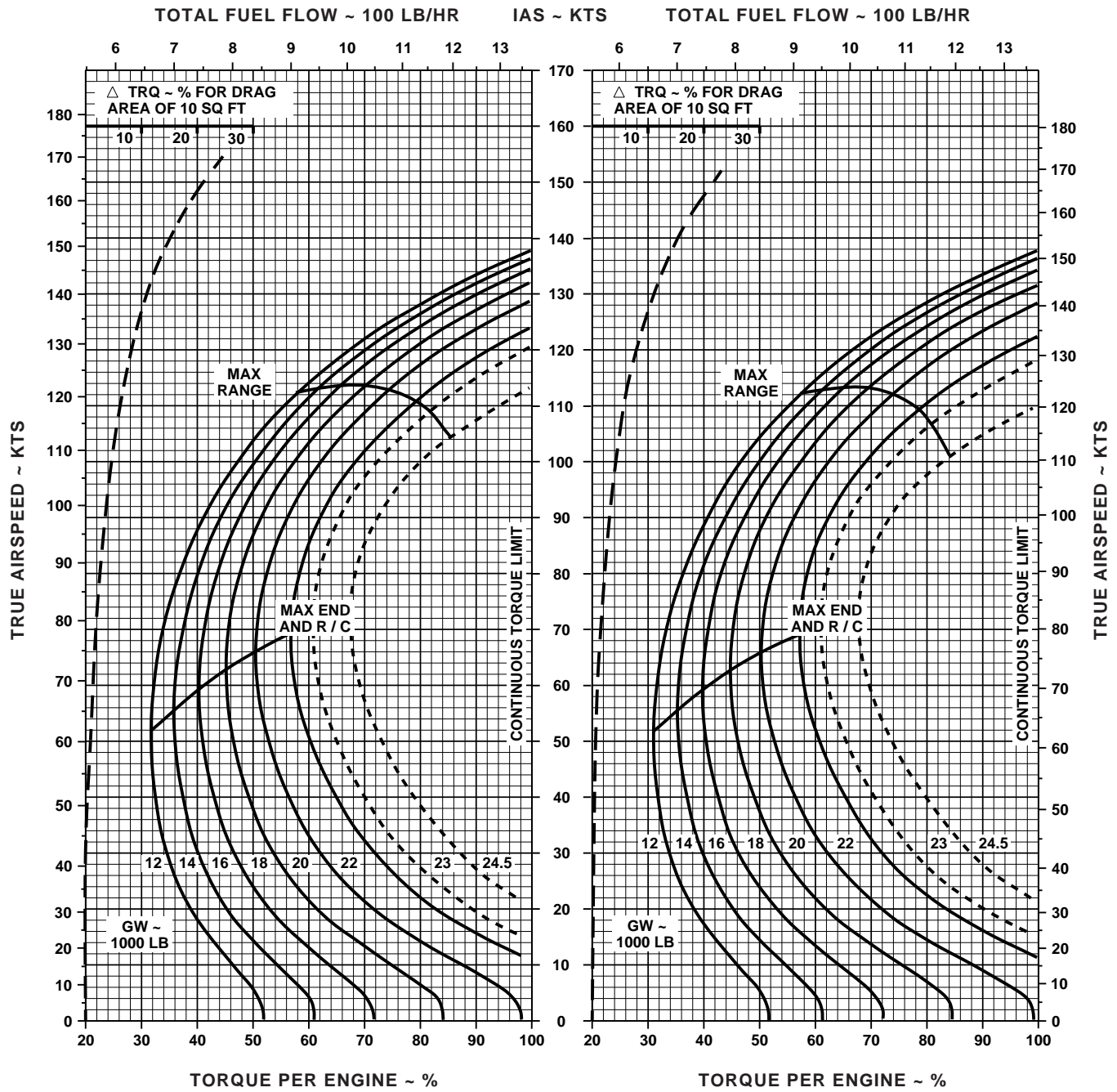

NOTE: SHORT DASH LINES: FERRY MISSION ONLY
 DATA BASE: FLIGHT TEST

AA1064_3
 SA

Figure 7A-14. Cruise High Drag - Pressure Altitude 4,000 Feet (Sheet 3 of 6)

CRUISE

PRESS ALT: 4000 FT

CRUISE
4000 FT
T701C (2)



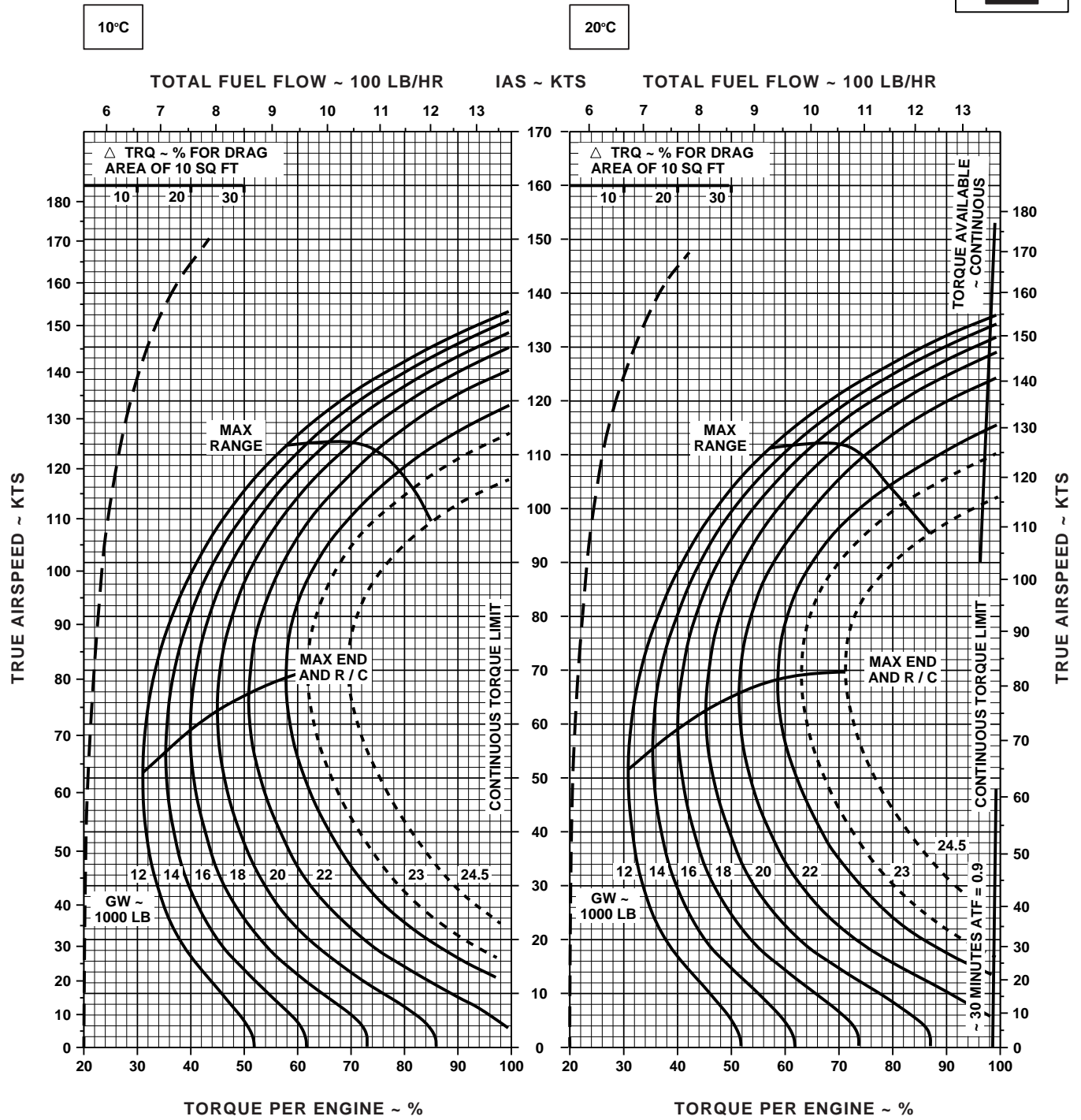

NOTE: SHORT DASH LINES: FERRY MISSION ONLY
DATA BASE: FLIGHT TEST

AA1064_4
SA

Figure 7A-14. Cruise High Drag - Pressure Altitude 4,000 Feet (Sheet 4 of 6)

CRUISE

PRESS ALT: 4000 FT

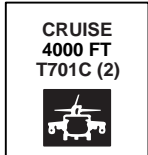

30°C

40°C

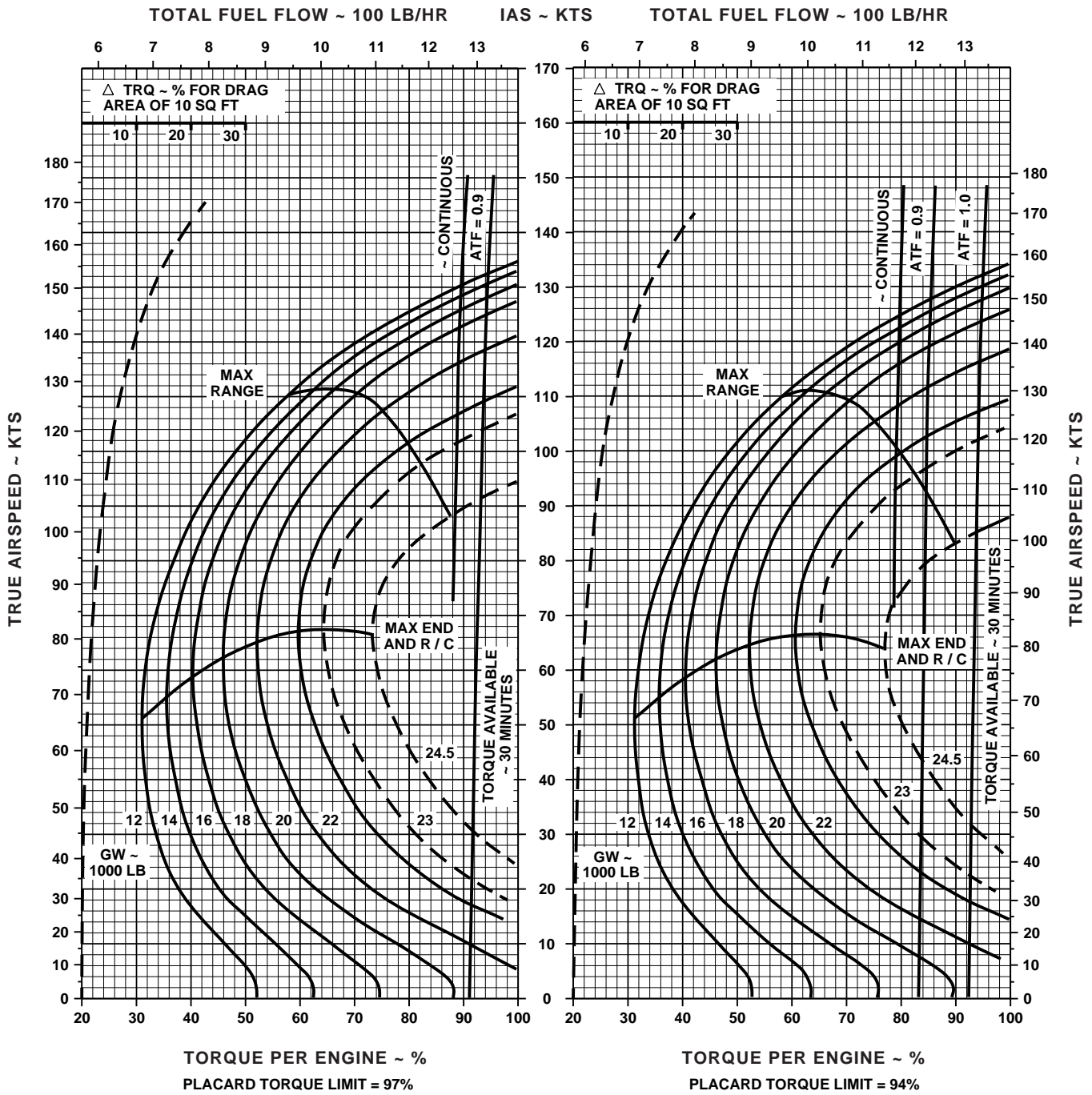

Figure 7A-14. Cruise High Drag - Pressure Altitude 4,000 Feet (Sheet 5 of 6)

CRUISE

PRESS ALT: 4000 FT

50°C



TOTAL FUEL FLOW ~ 100 LB/HR

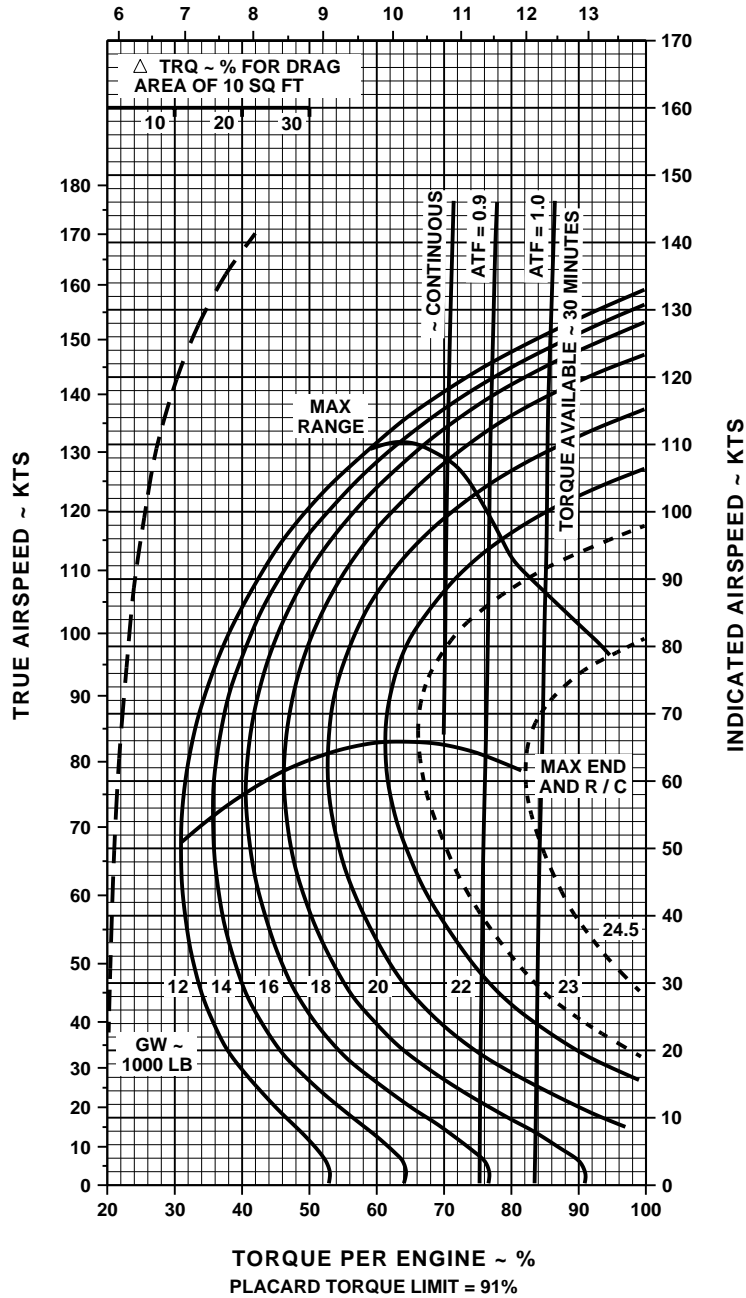

NOTE: SHORT DASH LINES: FERRY MISSION ONLY
 DATA BASE: FLIGHT TEST

AA1064_6
 SA

Figure 7A-14. Cruise High Drag - Pressure Altitude 4,000 Feet (Sheet 6 of 6)

CRUISE

CLEAN CONFIGURATION

PRESS ALT: 6,000 FT

CRUISE
6,000 FT
T701C (2)

-50°C

-40°C

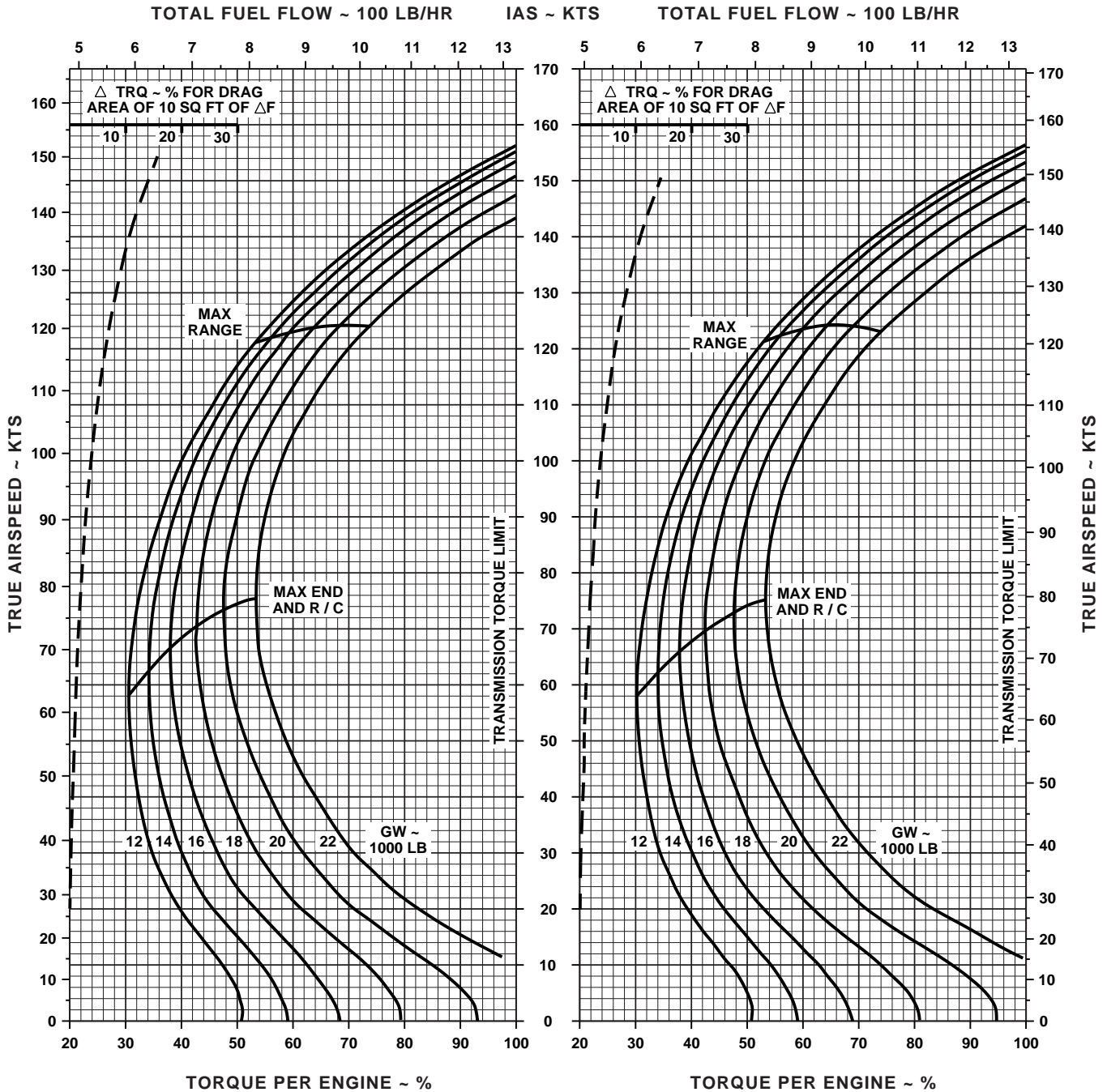

DATA BASE: FLIGHT TEST

AA1009_1
SA

Figure 7A-15. Cruise - Pressure Altitude 6,000 Feet (Sheet 1 of 6)

CRUISE

CLEAN CONFIGURATION

PRESS ALT: 6,000 FT

CRUISE
6,000 FT
T701C (2)

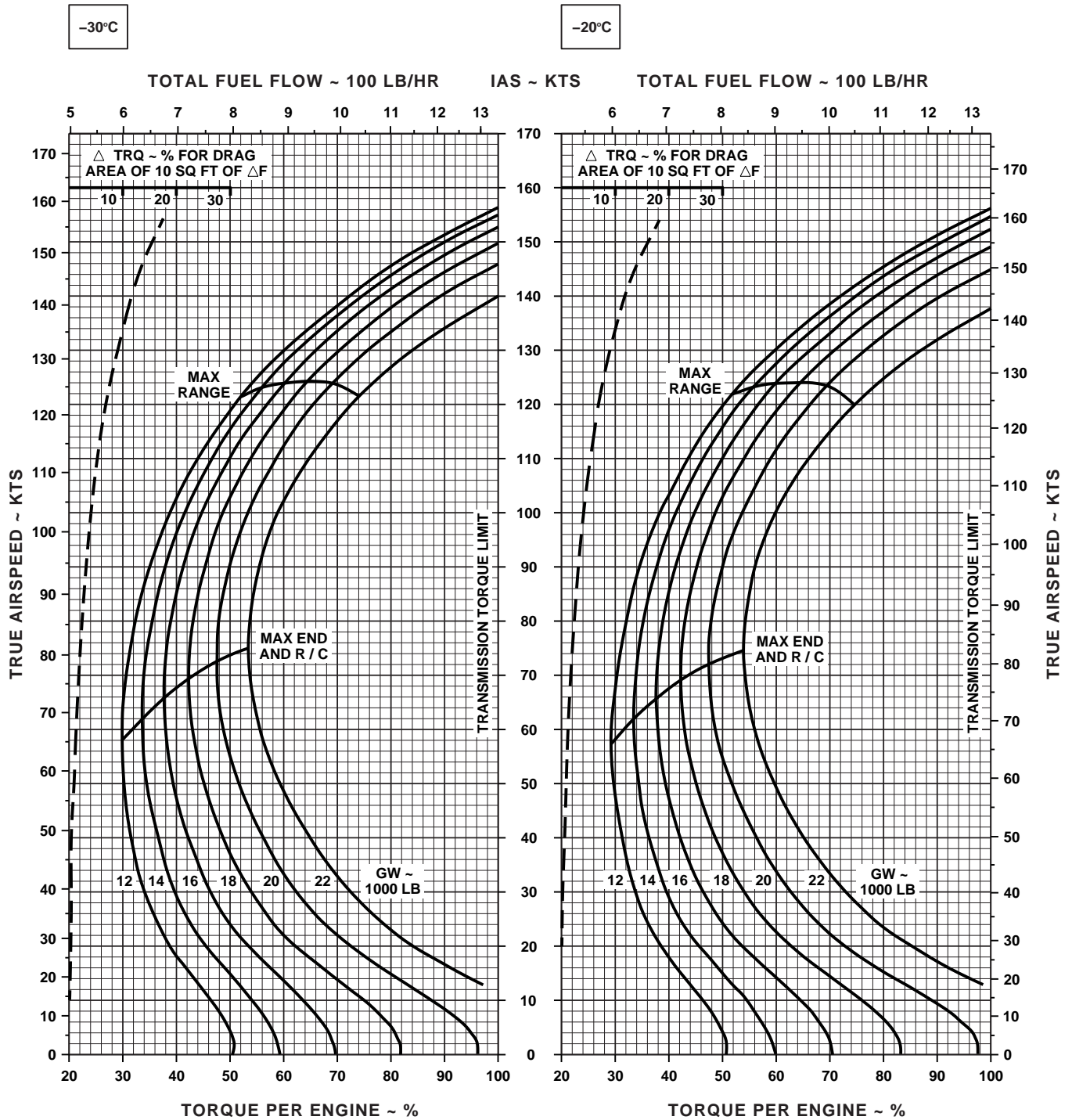

DATA BASE: FLIGHT TEST

AA1009_2
SA

Figure 7A-15. Cruise - Pressure Altitude 6,000 Feet (Sheet 2 of 6)

CRUISE

CLEAN CONFIGURATION

PRESS ALT: 6,000 FT

CRUISE
6,000 FT
T701C (2)

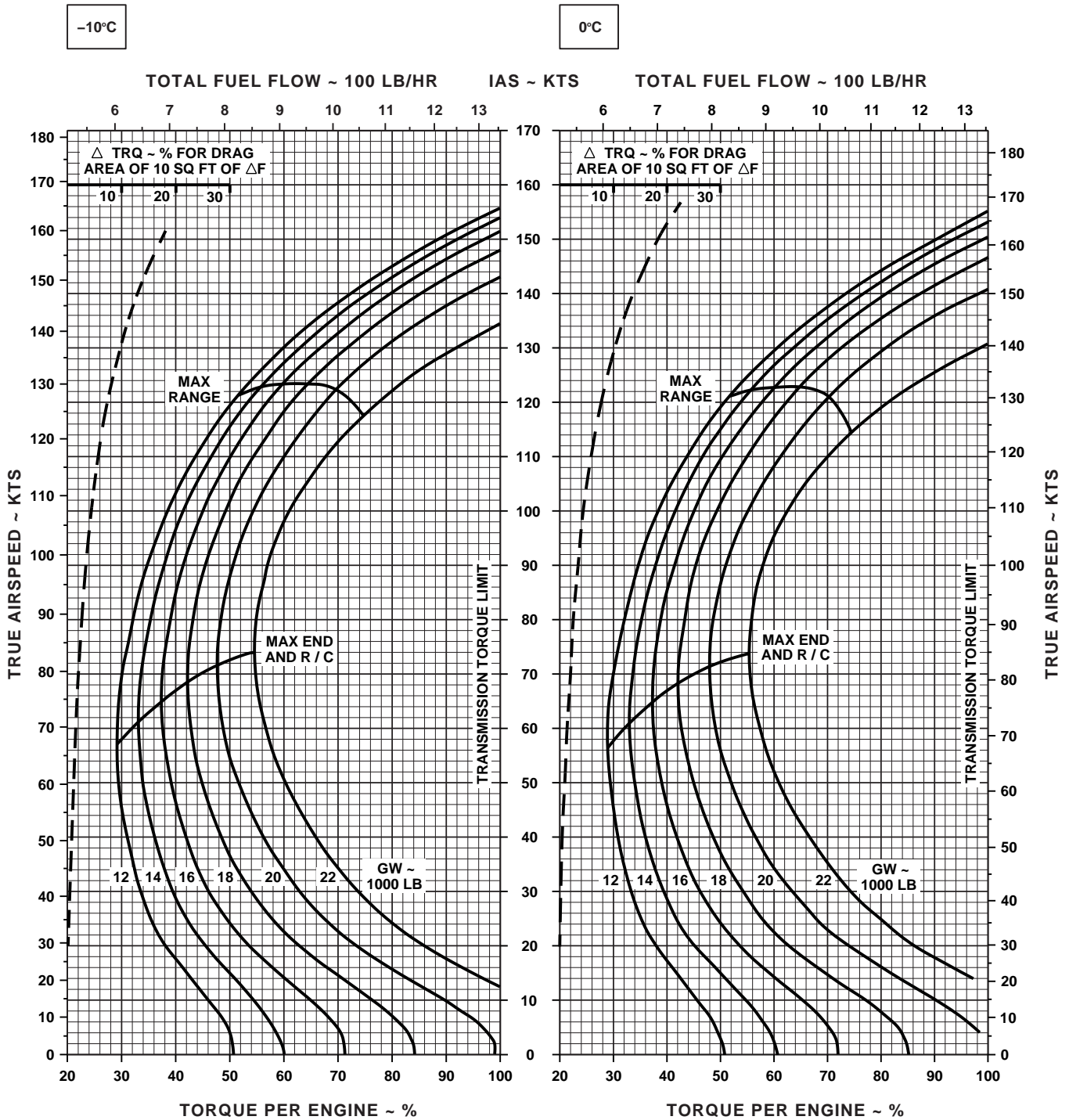

DATA BASE: FLIGHT TEST

AA1009_3
SA

Figure 7A-15. Cruise - Pressure Altitude 6,000 Feet (Sheet 3 of 6)

CRUISE

CLEAN CONFIGURATION

PRESS ALT: 6,000 FT

CRUISE
6,000 FT
T701C (2)

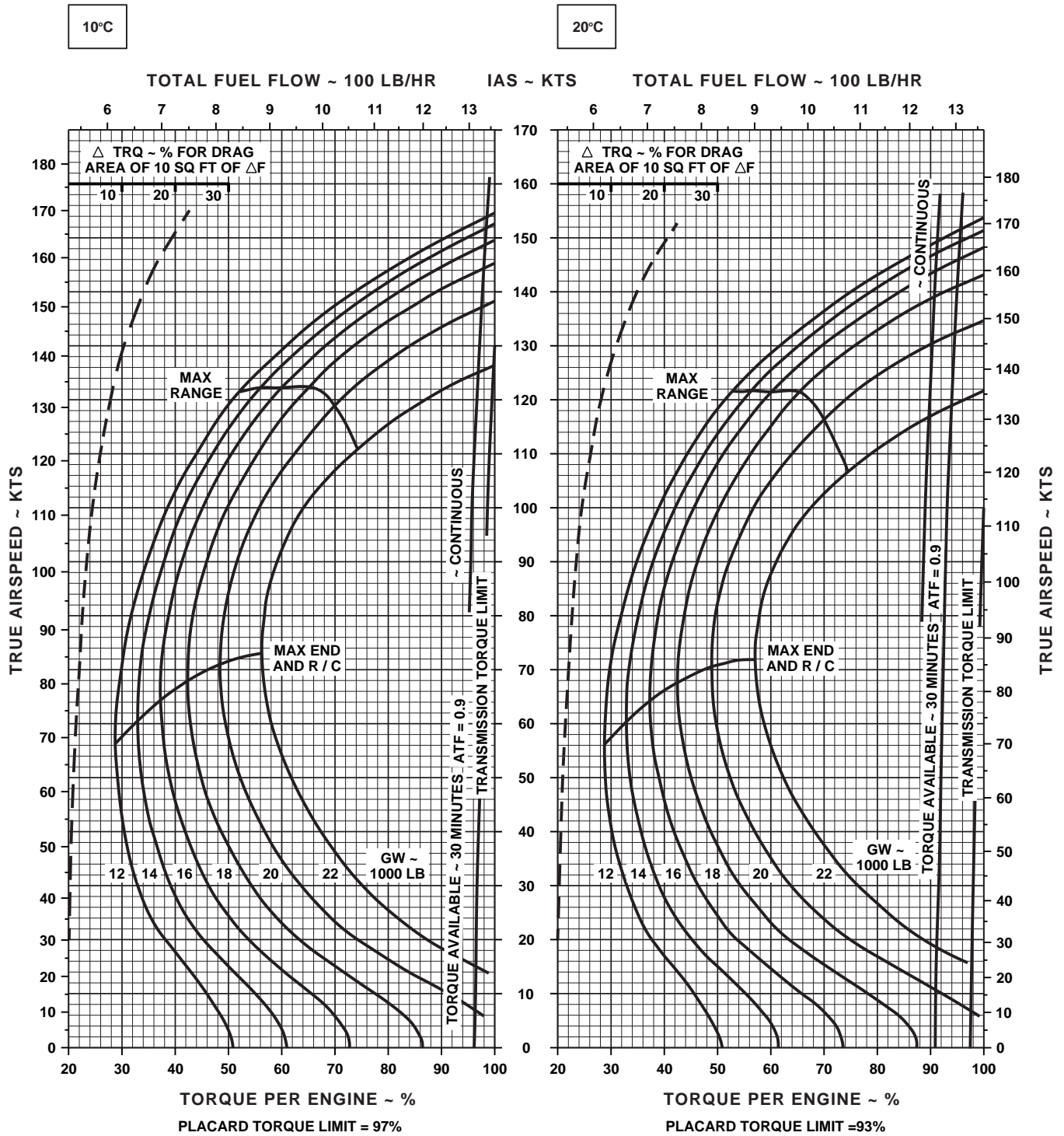

DATA BASE: FLIGHT TEST

AA1009_4
SA

Figure 7A-15. Cruise - Pressure Altitude 6,000 Feet (Sheet 4 of 6)

CRUISE

CLEAN CONFIGURATION

PRESS ALT: 6,000 FT

CRUISE
6,000 FT
T701C (2)

30°C

40°C

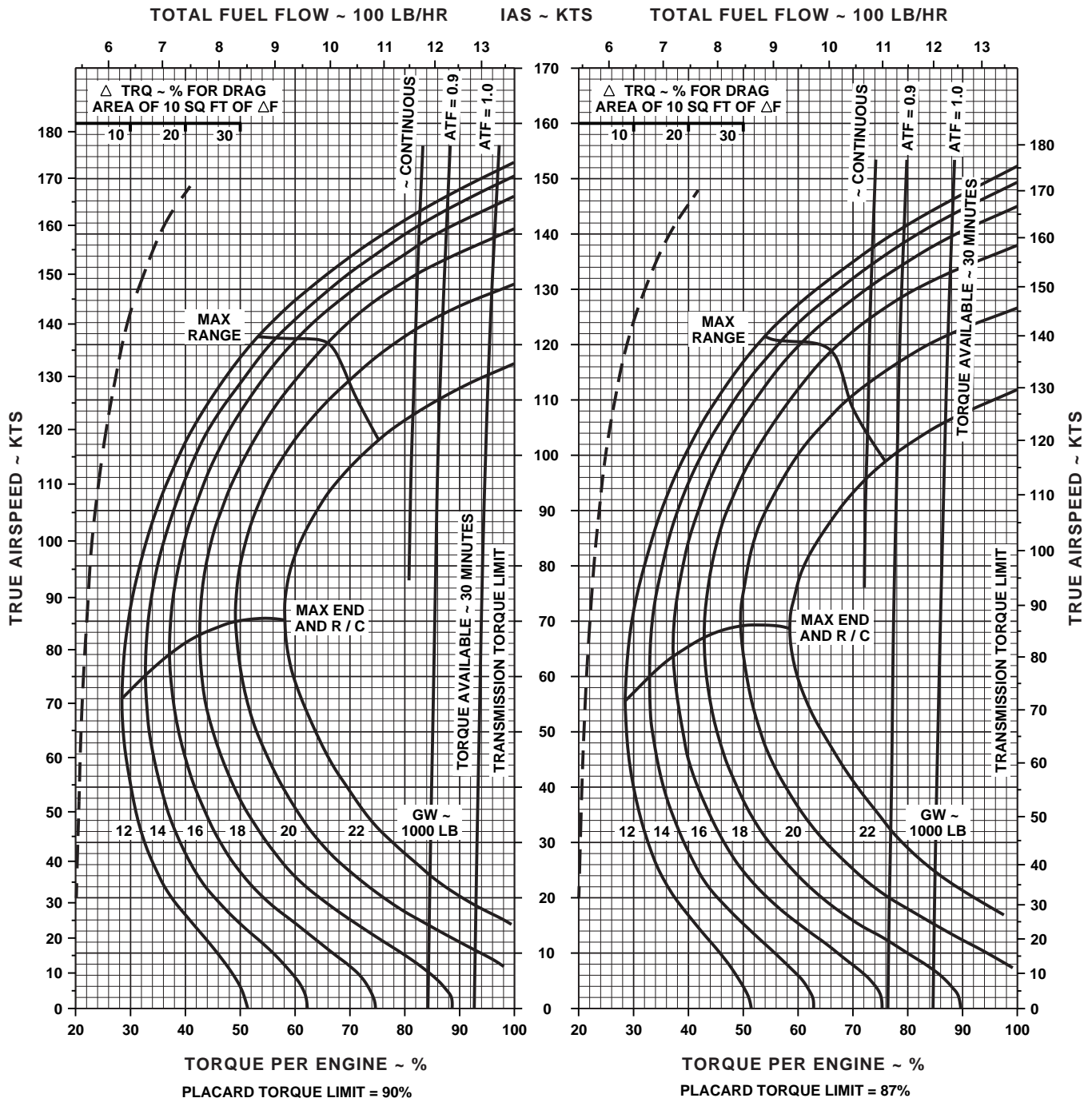

DATA BASE: FLIGHT TEST

AA1009_5
SA

Figure 7A-15. Cruise - Pressure Altitude 6,000 Feet (Sheet 5 of 6)

CRUISE

CLEAN CONFIGURATION

PRESS ALT: 6,000 FT

CRUISE
6,000 FT
T701C (2)

50°C

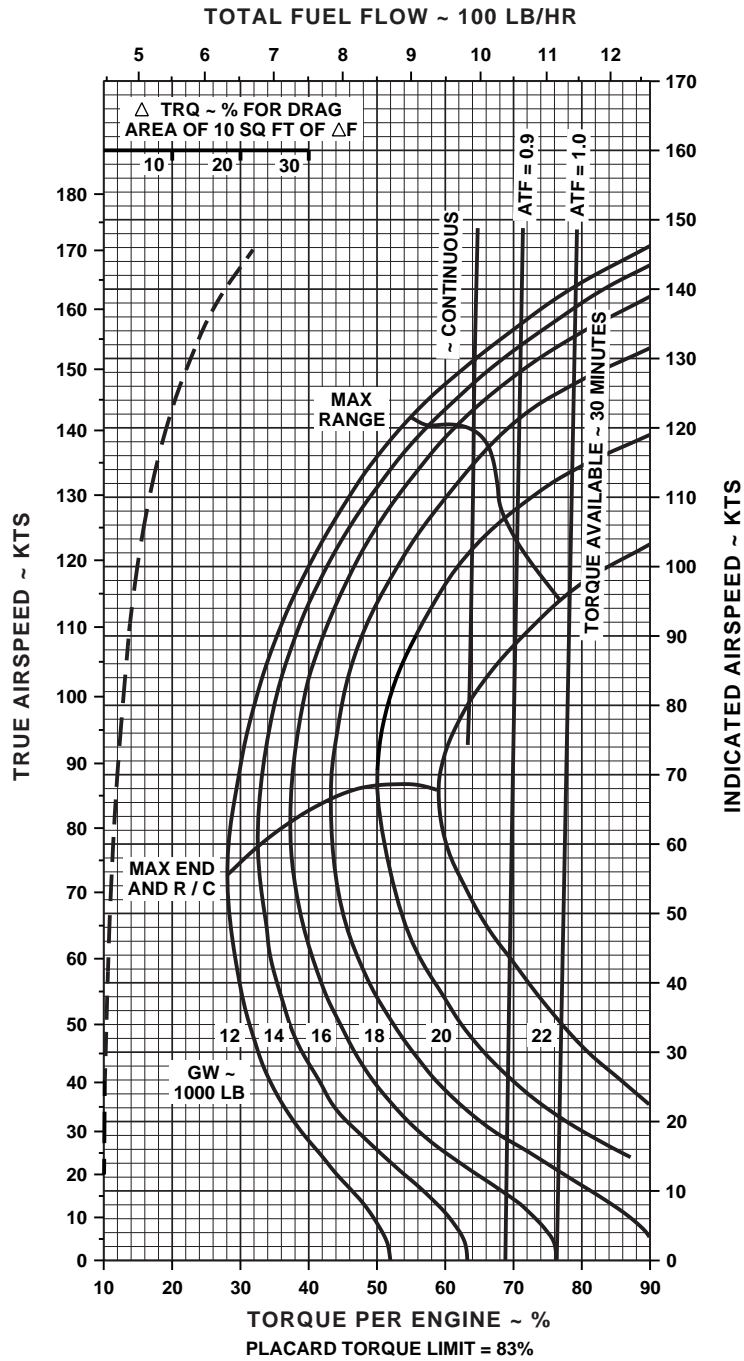

DATA BASE: FLIGHT TEST

AA1009_6
SA

Figure 7A-15. Cruise - Pressure Altitude 6,000 Feet (Sheet 6 of 6)

CRUISE

PRESS ALT: 6000 FT

CRUISE
6000 FT
T701C (2)



-50°C

-40°C

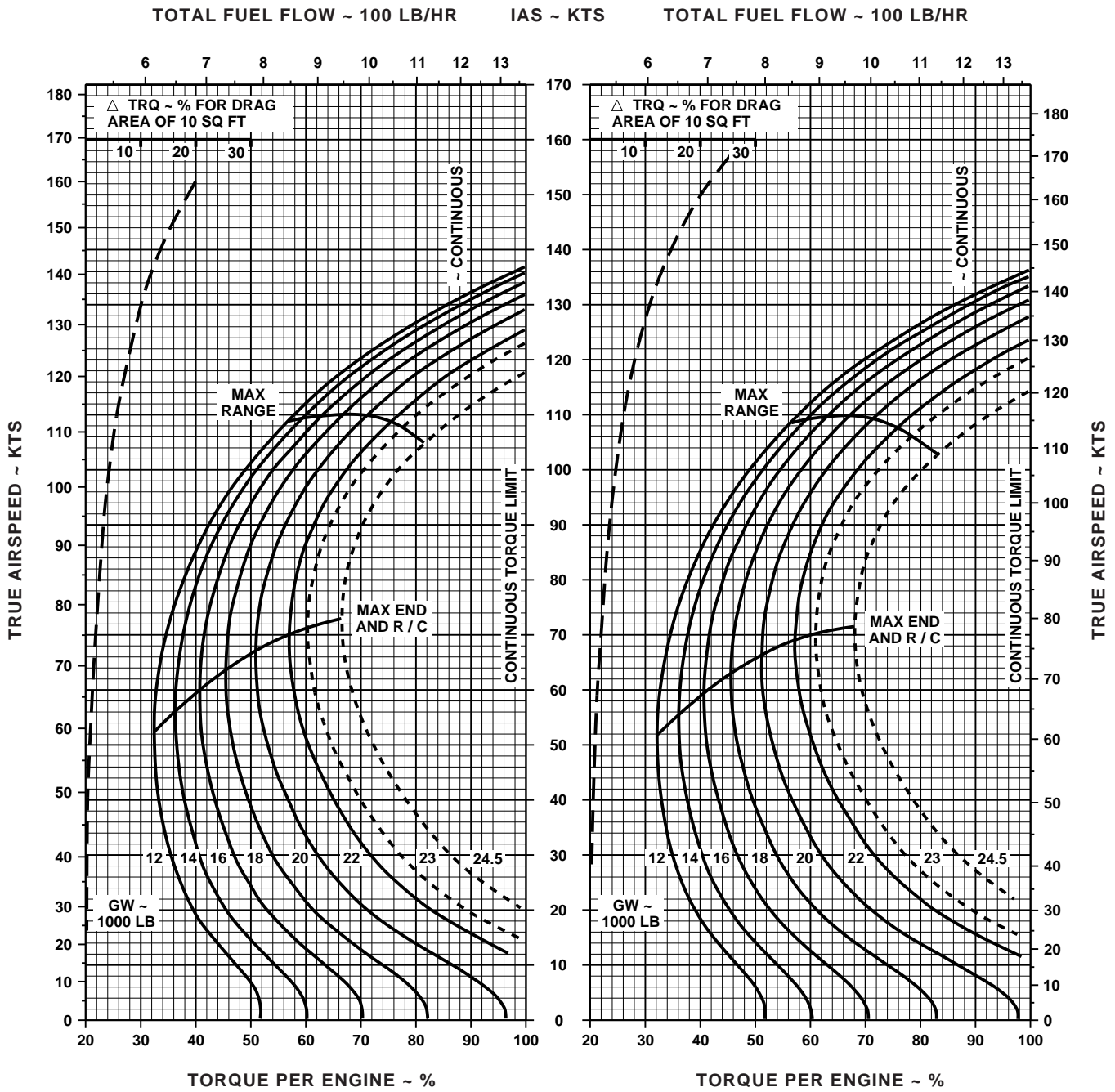

NOTE: SHORT DASH LINES: FERRY MISSION ONLY
DATA BASE: FLIGHT TEST

AA1010_1
SA

Figure 7A-16. Cruise High Drag - Pressure Altitude 6,000 Feet (Sheet 1 of 6)

CRUISE

PRESS ALT: 6000 FT

CRUISE
6000 FT
T701C (2)



-30°C

-20°C

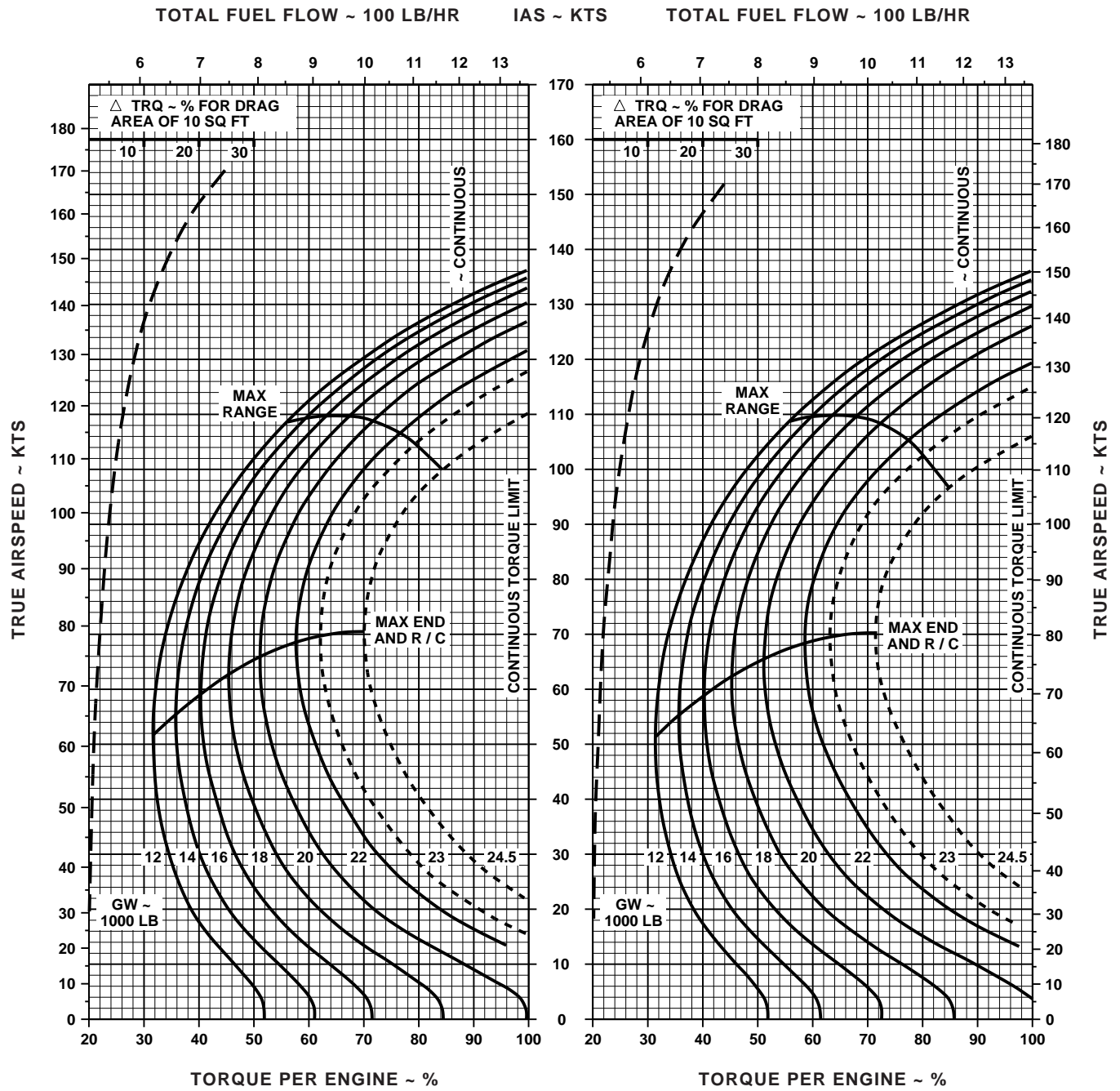

NOTE: SHORT DASH LINES: FERRY MISSION ONLY
DATA BASE: FLIGHT TEST

AA1010_2
SA

Figure 7A-16. Cruise High Drag - Pressure Altitude 6,000 Feet (Sheet 2 of 6)

CRUISE

PRESS ALT: 6000 FT

CRUISE
6000 FT
T701C (2)



-10°C

0°C

TOTAL FUEL FLOW ~ 100 LB/HR

IAS ~ KTS

TOTAL FUEL FLOW ~ 100 LB/HR

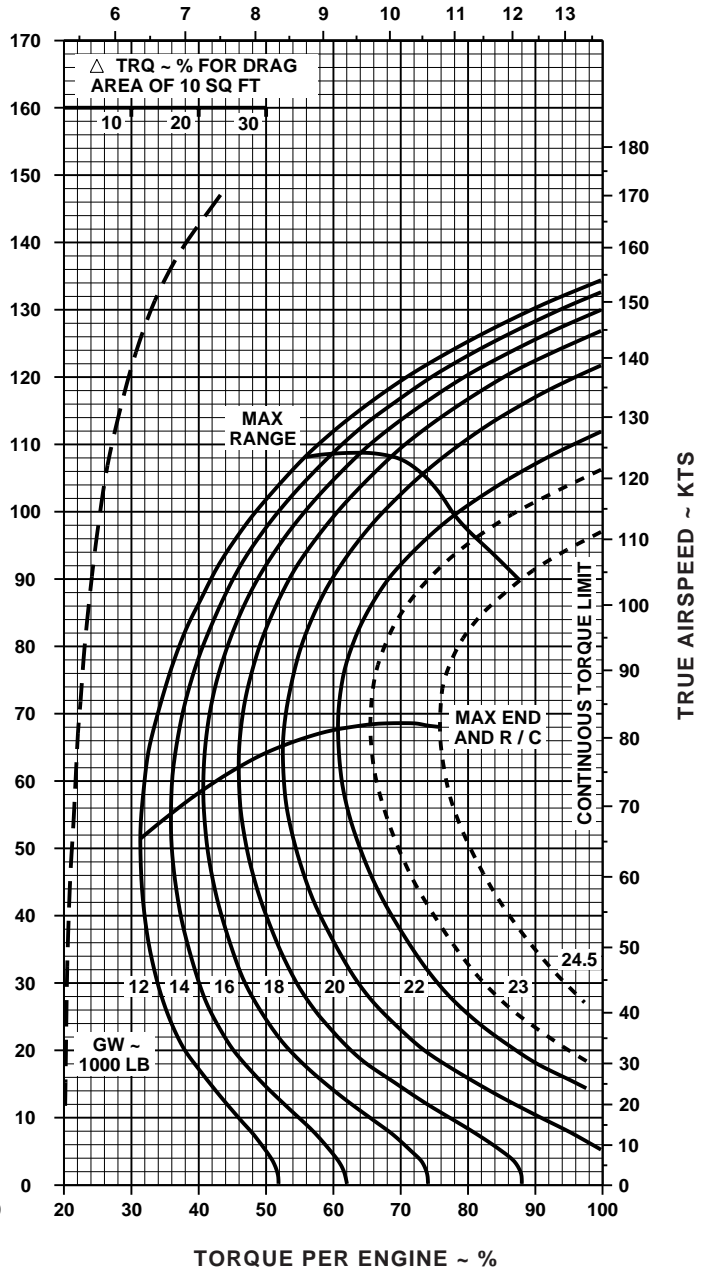
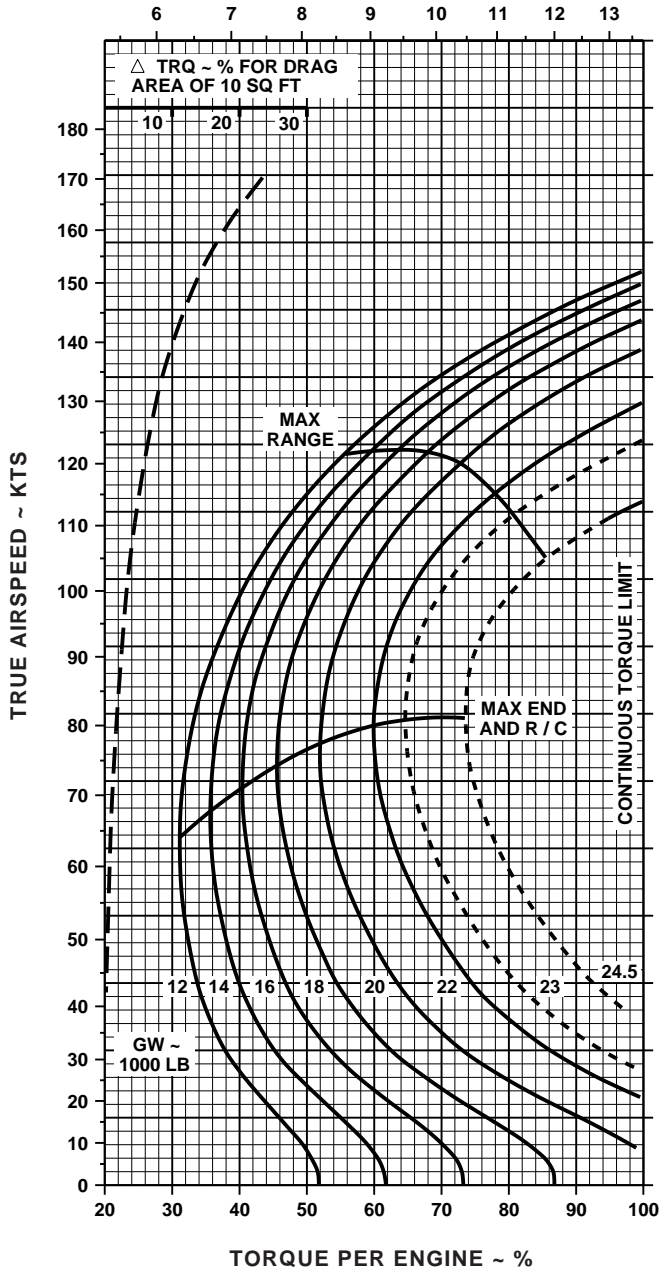

NOTE: SHORT DASH LINES: FERRY MISSION ONLY
DATA BASE: FLIGHT TEST

AA1010_3
SA

Figure 7A-16. Cruise High Drag - Pressure Altitude 6,000 Feet (Sheet 3 of 6)

CRUISE

PRESS ALT: 6000 FT

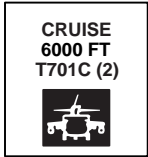

10°C

20°C

TOTAL FUEL FLOW ~ 100 LB/HR

IAS ~ KTS

TOTAL FUEL FLOW ~ 100 LB/HR

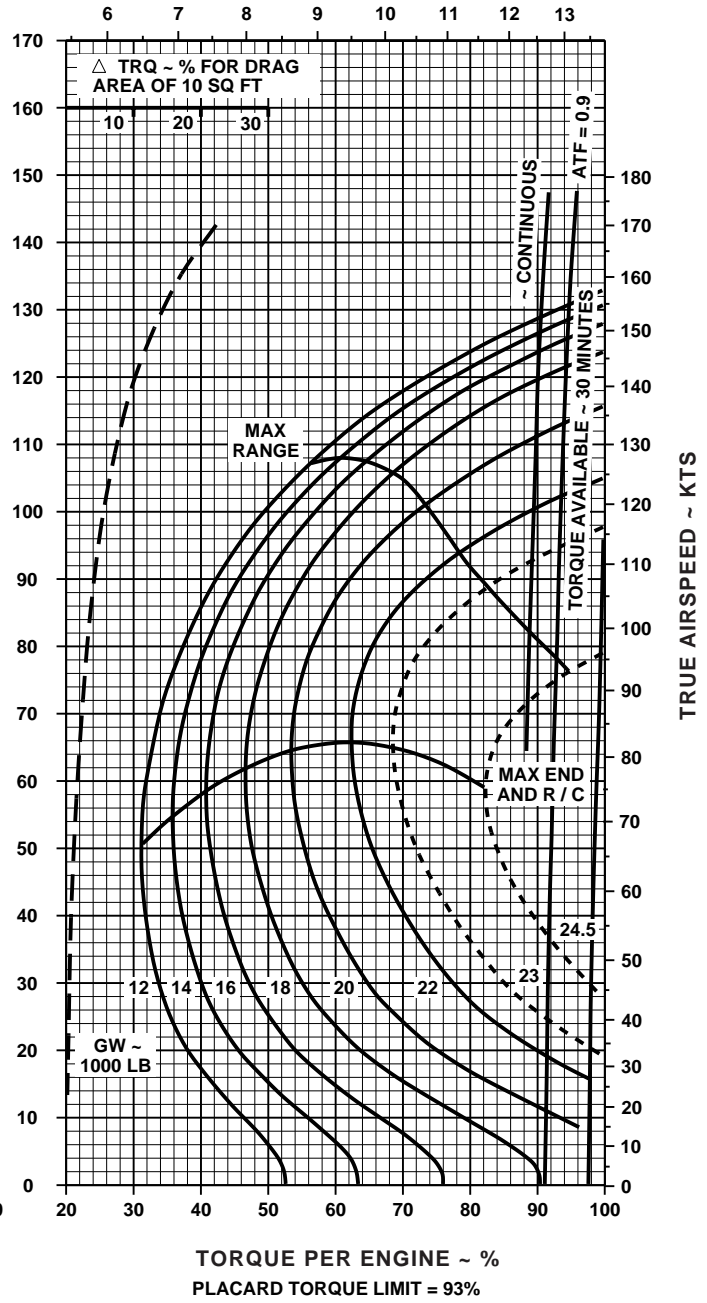
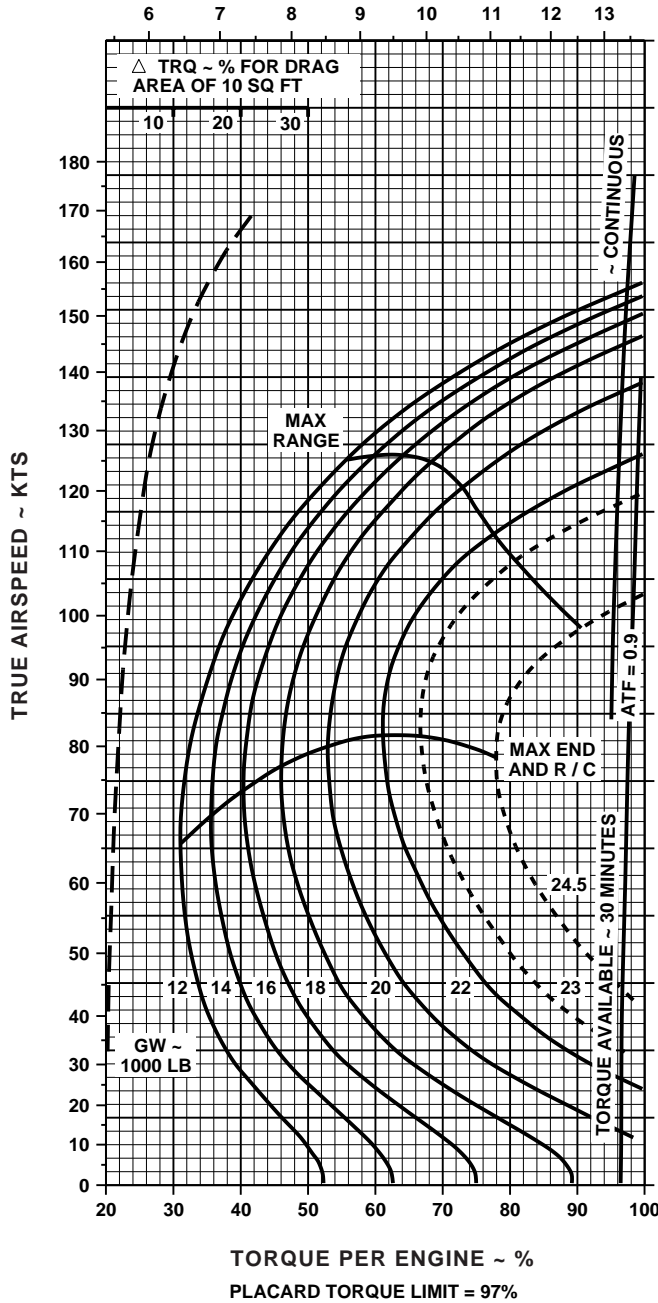

NOTE: SHORT DASH LINES: FERRY MISSION ONLY
 DATA BASE: FLIGHT TEST

AA1010_4 SA

Figure 7A-16. Cruise High Drag - Pressure Altitude 6,000 Feet (Sheet 4 of 6)

CRUISE

PRESS ALT: 6000 FT

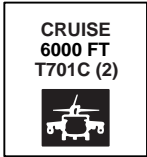

30°C

40°C

TOTAL FUEL FLOW ~ 100 LB/HR

IAS ~ KTS

TOTAL FUEL FLOW ~ 100 LB/HR

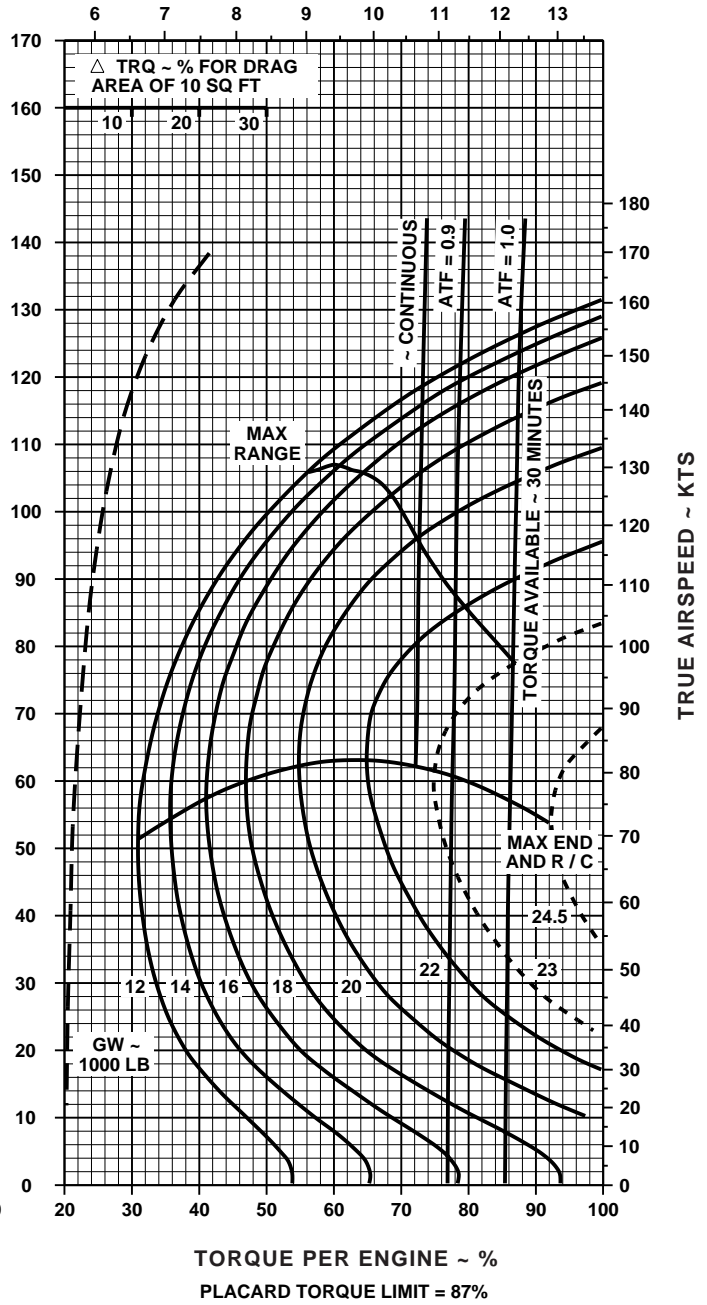
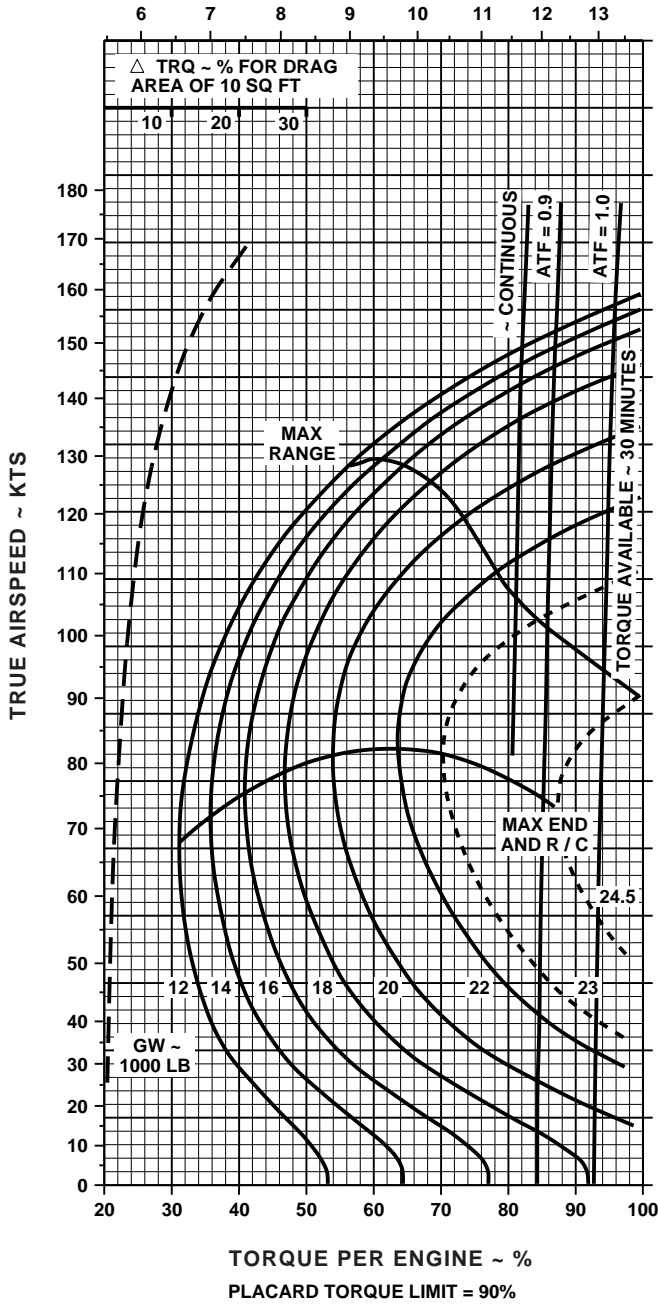

NOTE: SHORT DASH LINES: FERRY MISSION ONLY
DATA BASE: FLIGHT TEST

AA1010_5 SA

Figure 7A-16. Cruise High Drag - Pressure Altitude 6,000 Feet (Sheet 5 of 6)

CRUISE

PRESS ALT: 6000 FT



50°C

TOTAL FUEL FLOW ~ 100 LB/HR

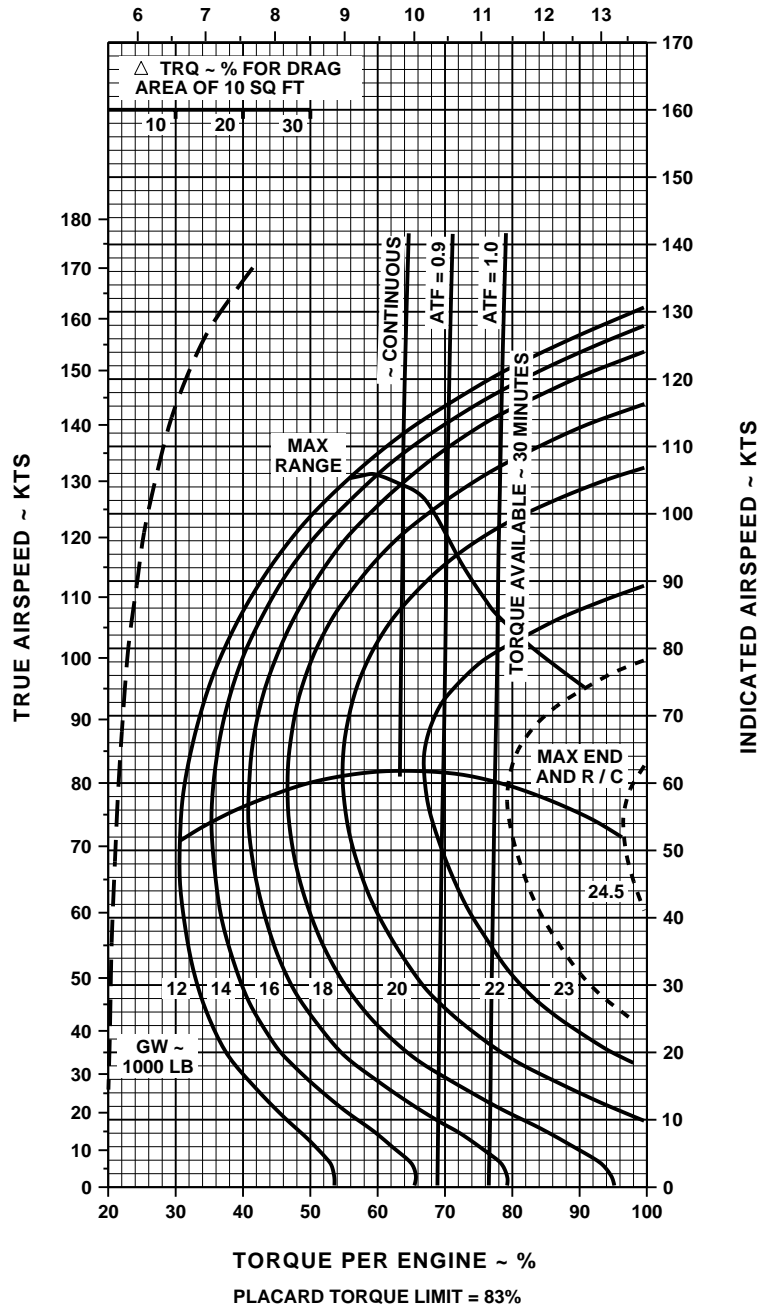

NOTE: SHORT DASH LINES: FERRY MISSION ONLY
DATA BASIS: FLIGHT TEST

AA2101_6 SA

Figure 7A-16. Cruise High Drag - Pressure Altitude 6,000 Feet (Sheet 6 of 6)

CRUISE

CLEAN CONFIGURATION

PRESS ALT: 8,000 FT

CRUISE
8,000 FT
T701C (2)

-50°C

-40°C

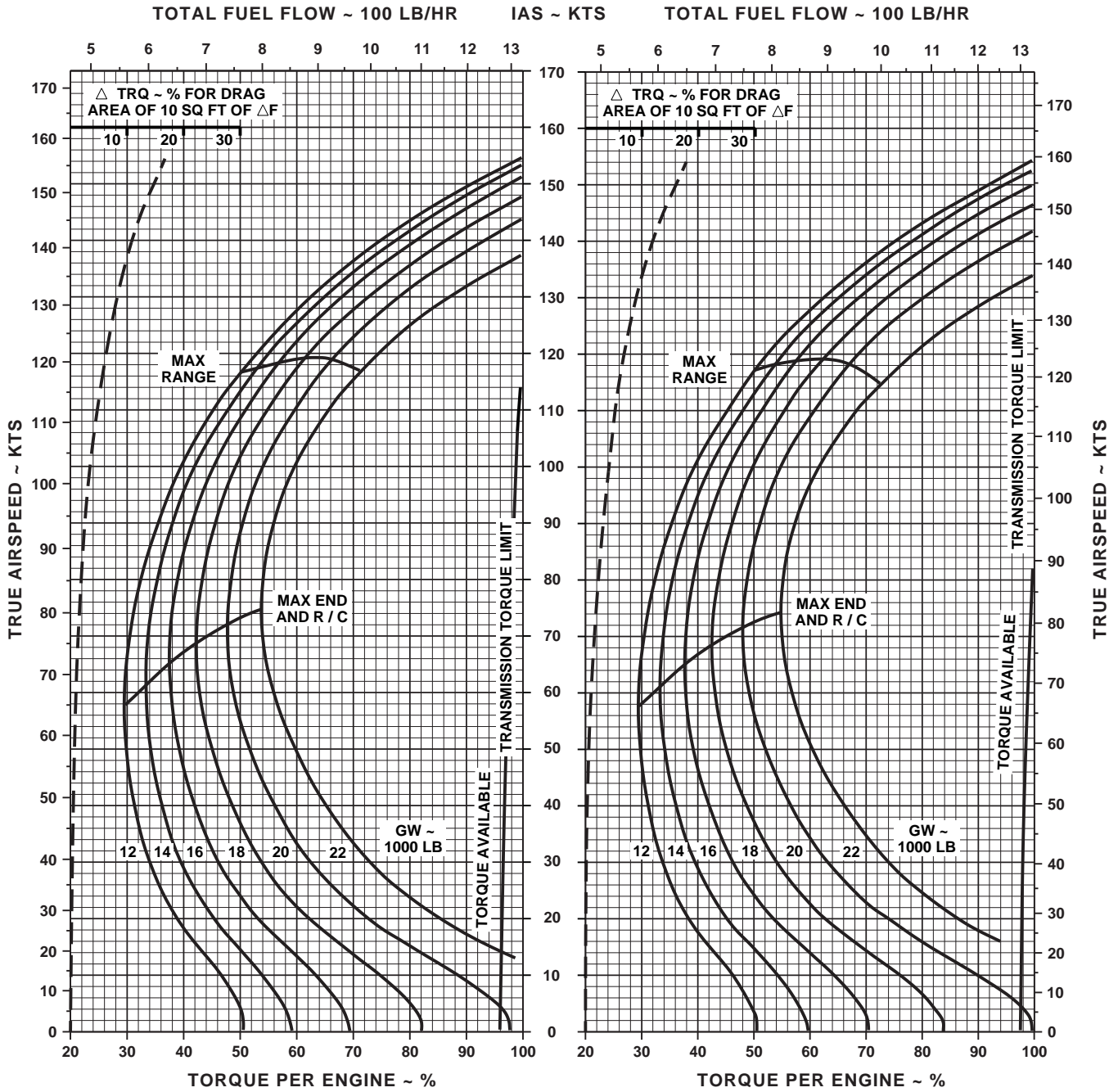

DATA BASE: FLIGHT TEST

AA1011_1
SA

Figure 7A-17. Cruise - Pressure Altitude 8,000 Feet (Sheet 1 of 6)

CRUISE

CLEAN CONFIGURATION

PRESS ALT: 8000 FT

CRUISE
8000 FT
T701C (2)

-30°C

-20°C

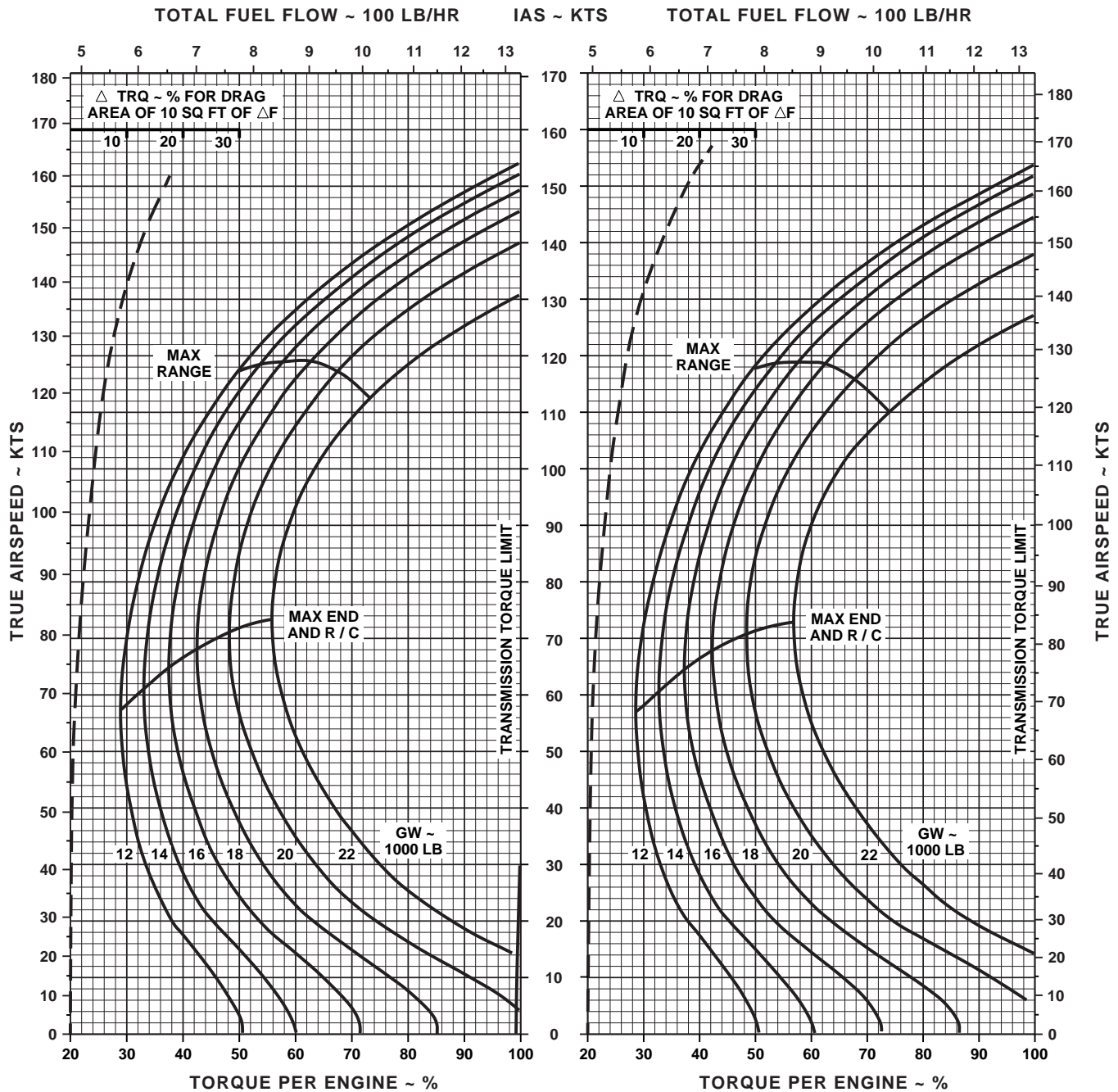

DATA BASE: FLIGHT TEST

AA1011_2
SA

Figure 7A-17. Cruise - Pressure Altitude 8,000 Feet (Sheet 2 of 6)

CRUISE

CLEAN CONFIGURATION

PRESS ALT: 8,000 FT

CRUISE
8,000 FT
T701C (2)

-10°C

0°C

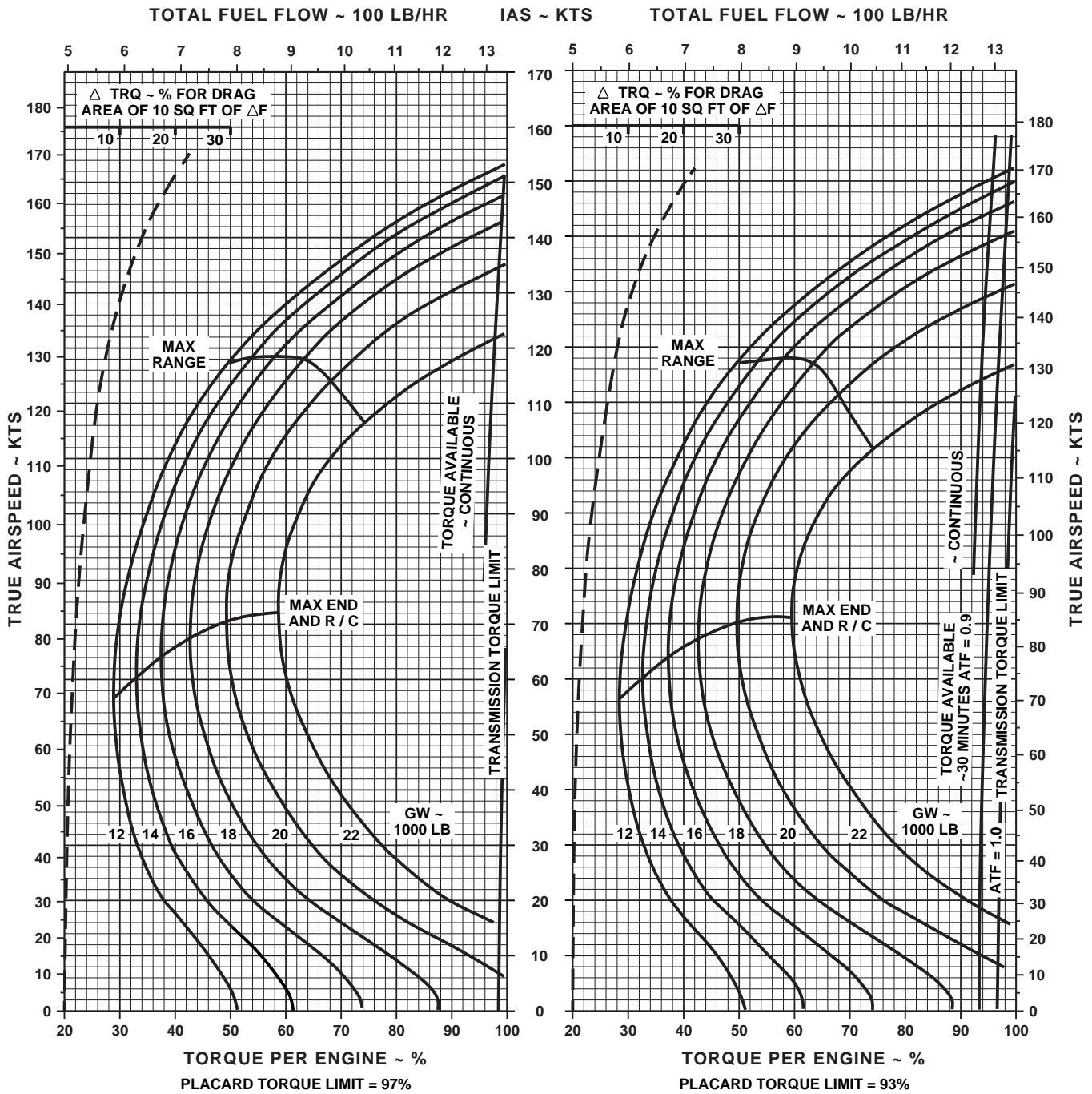

DATA BASE: FLIGHT TEST

AA1011_3
SA

Figure 7A-17. Cruise - Pressure Altitude 8,000 Feet (Sheet 3 of 6)

CRUISE

CLEAN CONFIGURATION

PRESS ALT: 8,000 FT

CRUISE
8,000 FT
T701C (2)

10°C

20°C

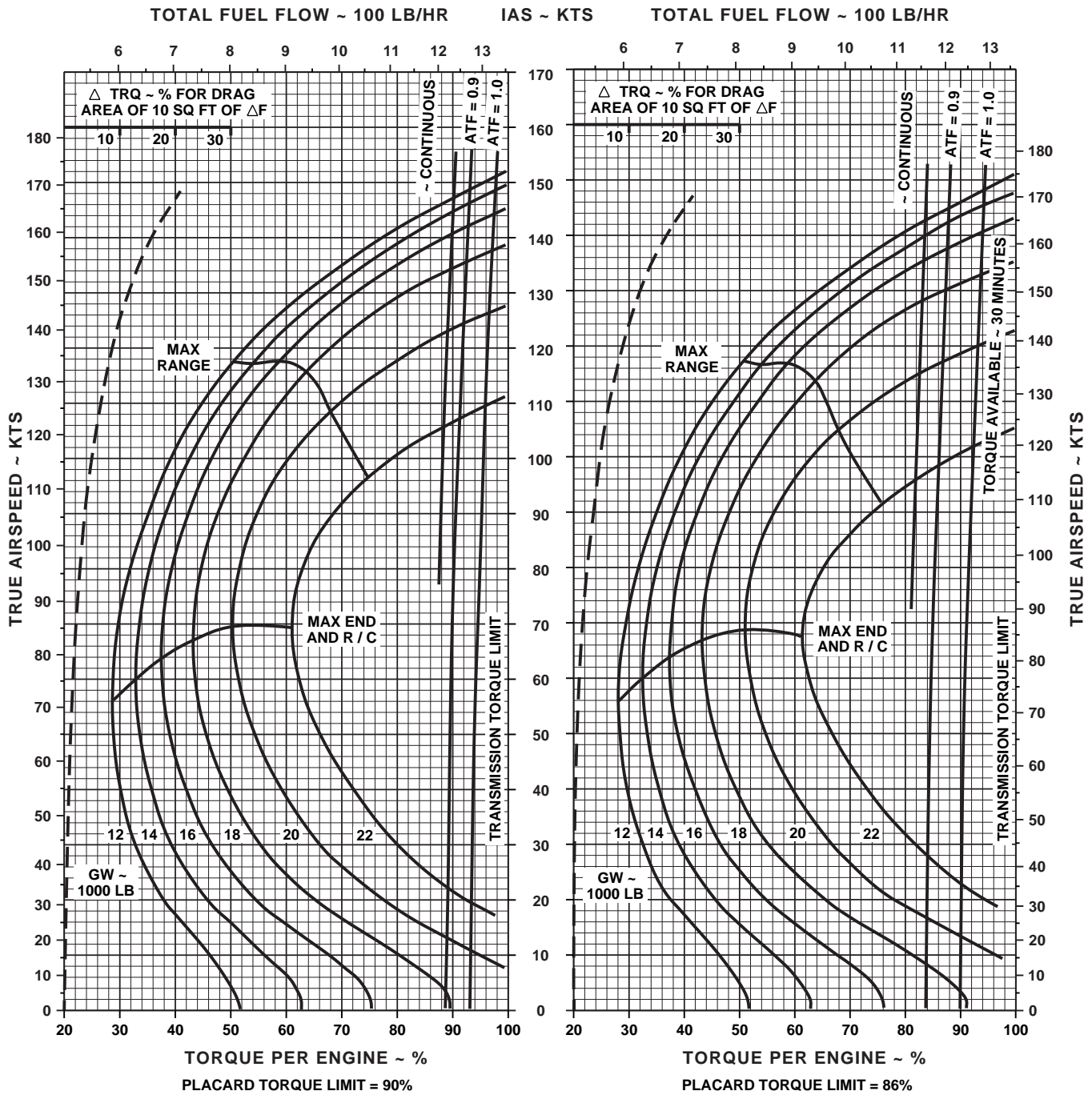

DATA BASE: FLIGHT TEST

AA1011_4
SA

Figure 7A-17. Cruise - Pressure Altitude 8,000 Feet (Sheet 4 of 6)

CRUISE

CLEAN CONFIGURATION

PRESS ALT: 8,000 FT

CRUISE
8,000 FT
T701C (2)

30°C

40°C

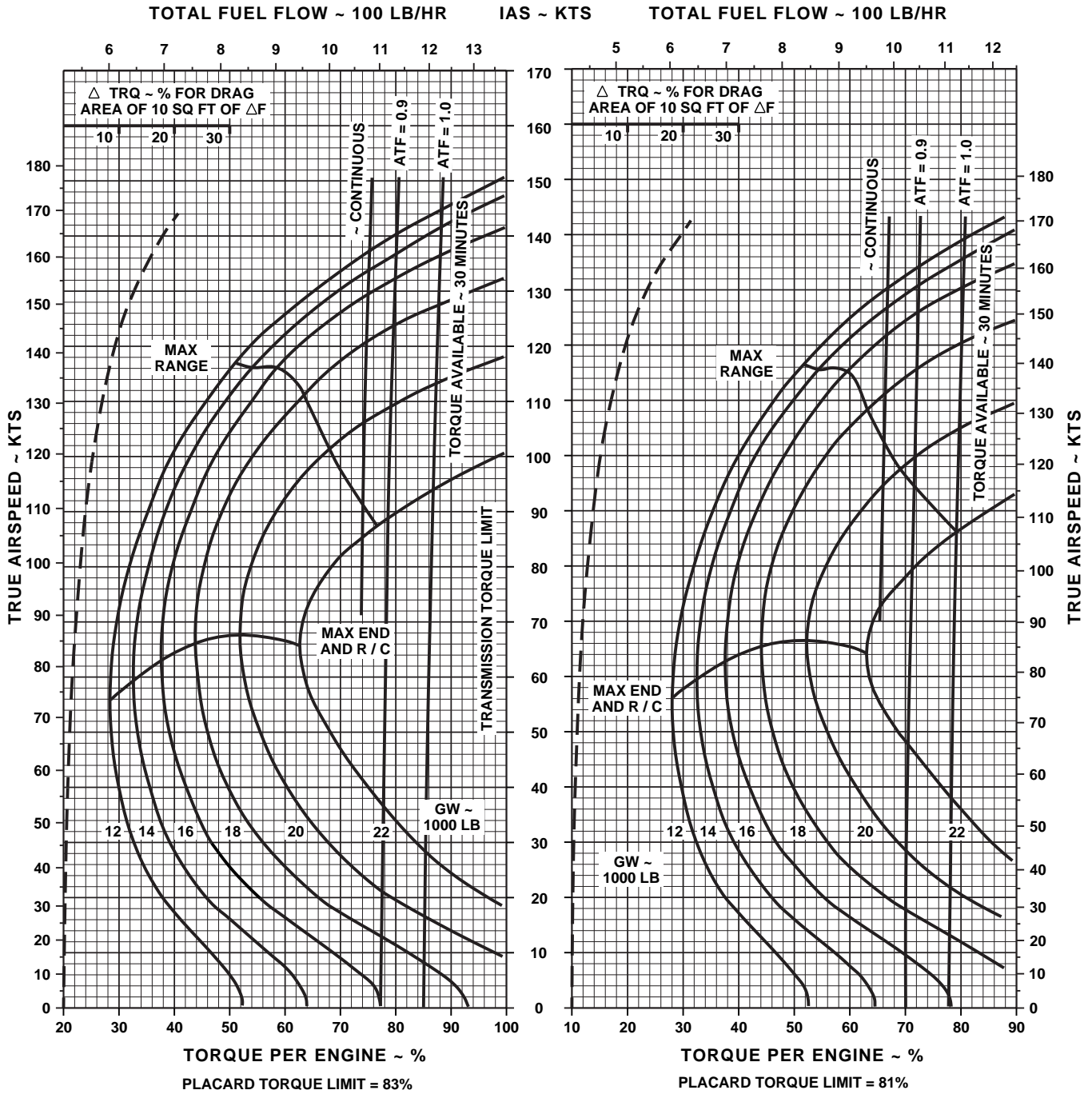

DATA BASE: FLIGHT TEST

AA1011_5
SA

Figure 7A-17. Cruise - Pressure Altitude 8,000 Feet (Sheet 5 of 6)

CRUISE

CLEAN CONFIGURATION

PRESS ALT: 8,000 FT

CRUISE
8,000 FT
T701C (2)

50°C

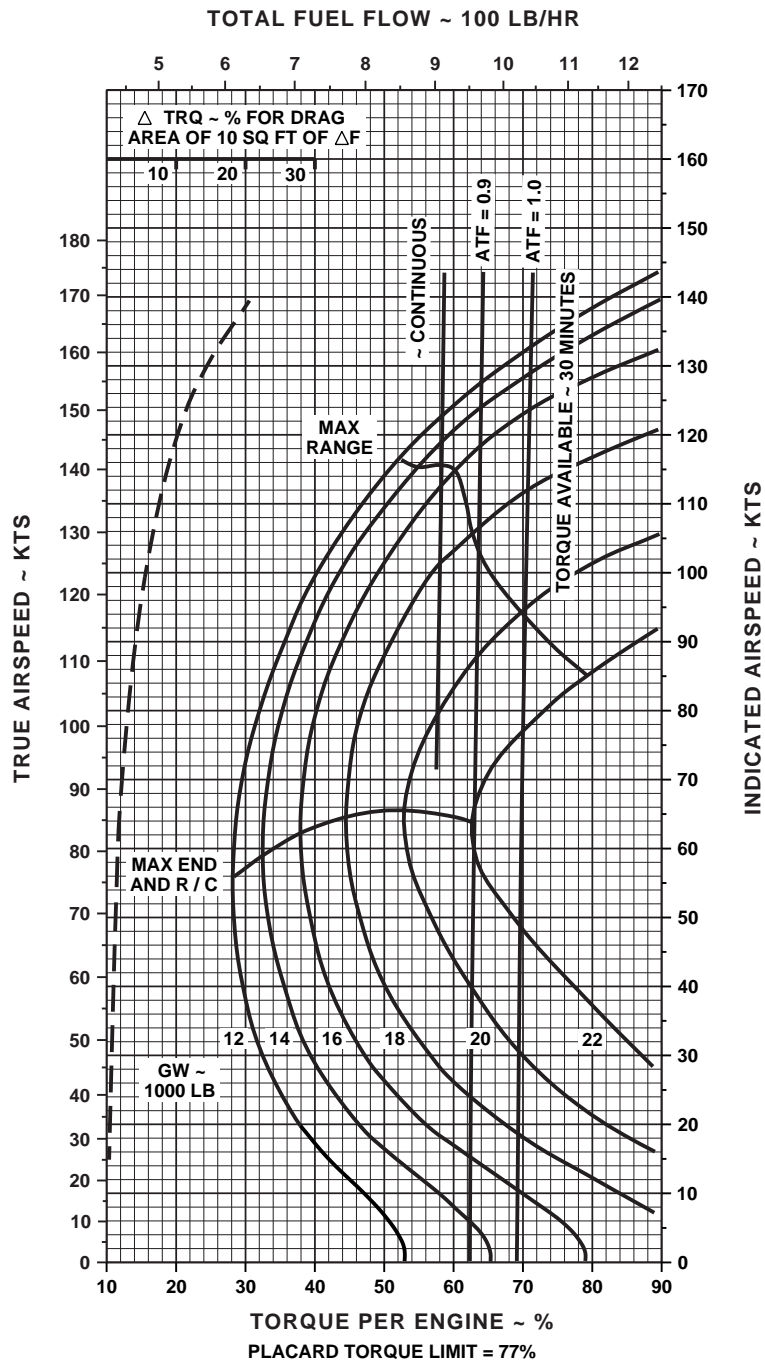

DATA BASE: FLIGHT TEST

AA1011_6
SA

Figure 7A-17. Cruise - Pressure Altitude 8,000 Feet (Sheet 6 of 6)

CRUISE

PRESS ALT: 8000 FT

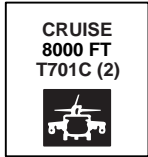

-50°C

-40°C

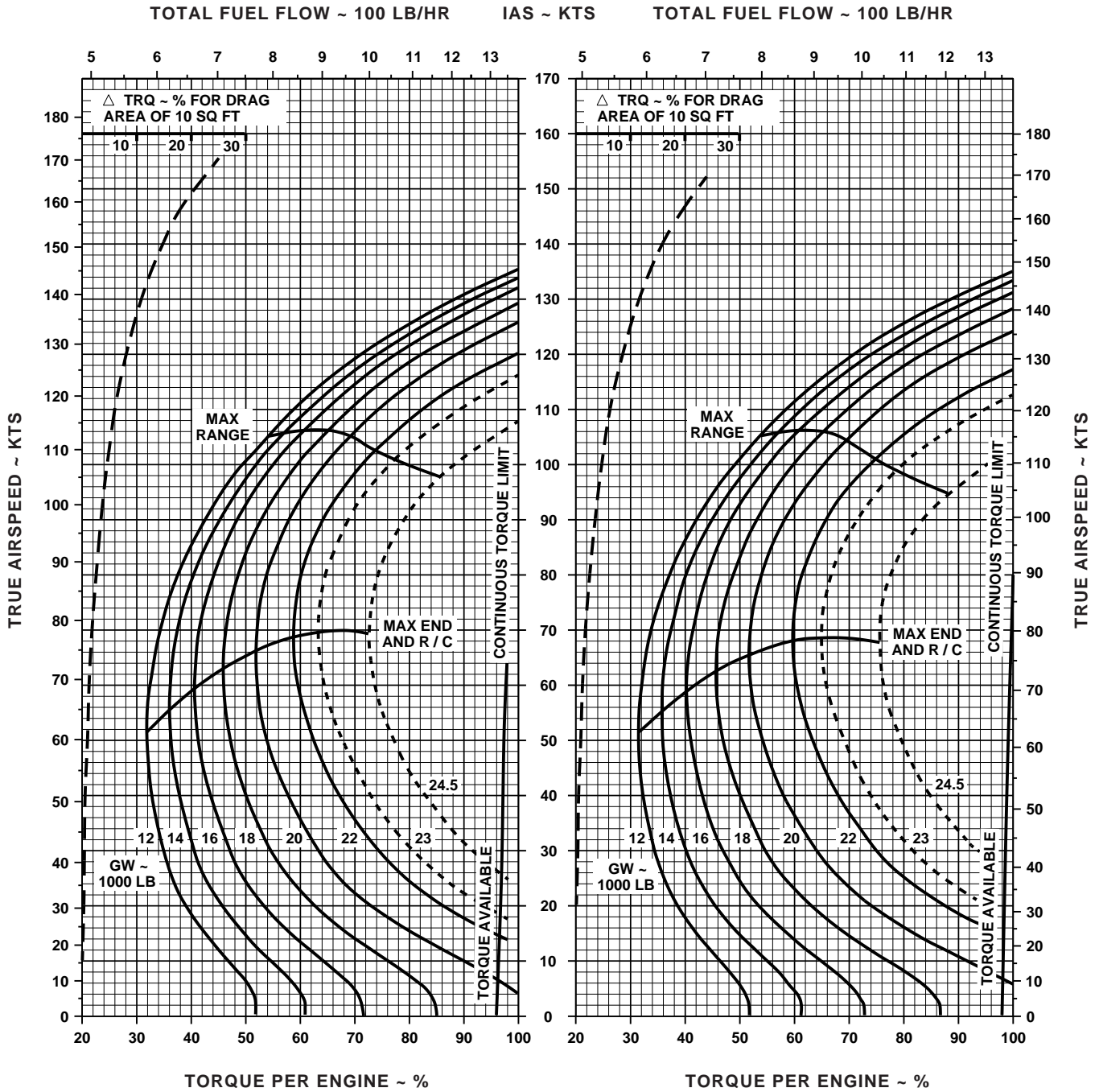

NOTE: SHORT DASH LINES: FERRY MISSION ONLY
 DATA BASE: FLIGHT TEST

AA1012_1
 SA

Figure 7A-18. Cruise High Drag - Pressure Altitude 8,000 Feet (Sheet 1 of 6)

CRUISE

PRESS ALT: 8000 FT

CRUISE
8000 FT
T701C (2)



-30°C

-20°C

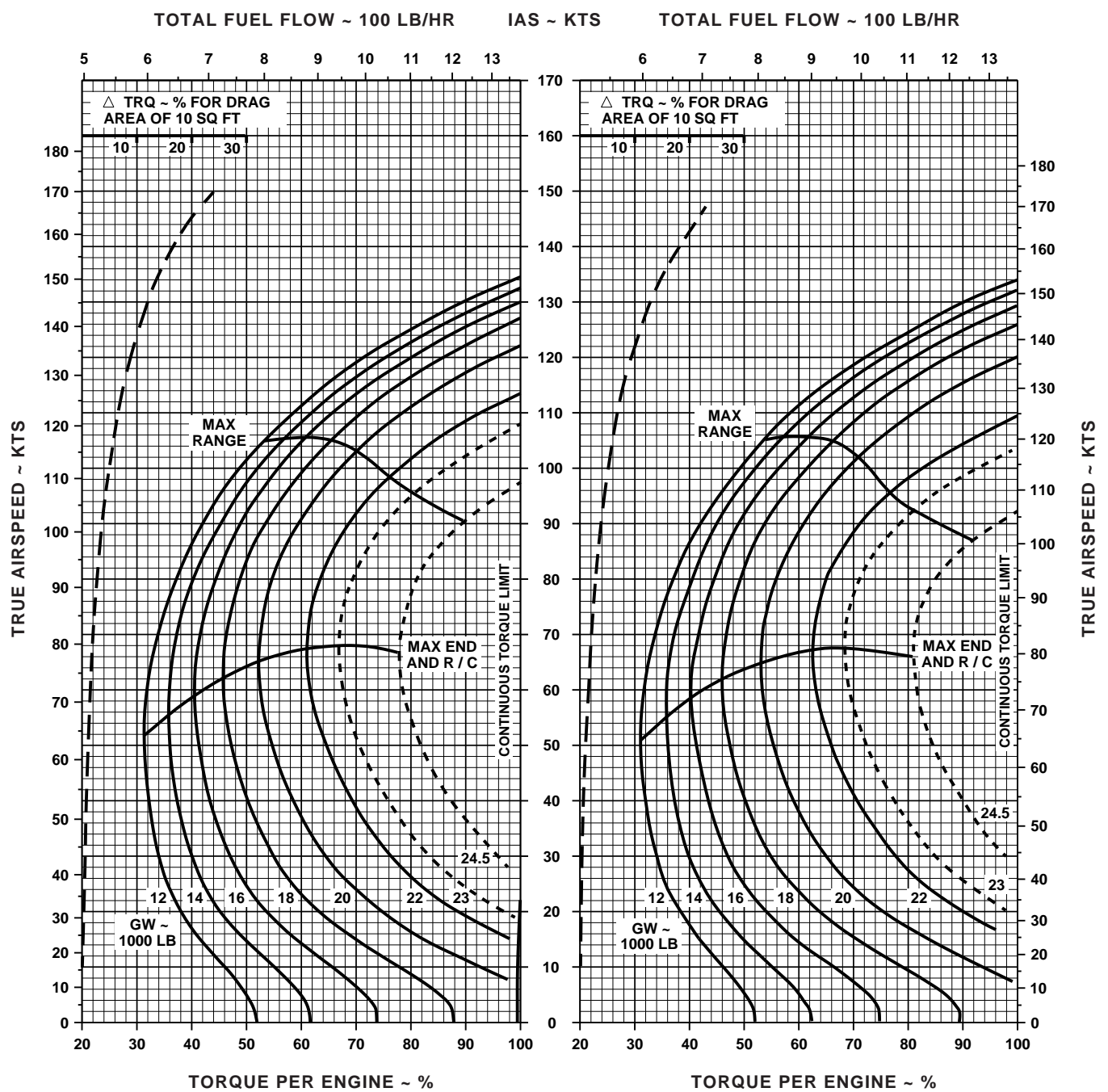

NOTE: SHORT DASH LINES: FERRY MISSION ONLY
DATA BASE: FLIGHT TEST

AA1012_2
SA

Figure 7A-18. Cruise High Drag - Pressure Altitude 8,000 Feet (Sheet 2 of 6)

CRUISE

PRESS ALT: 8000 FT

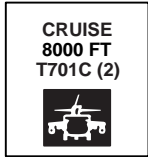

-10°C

0°C

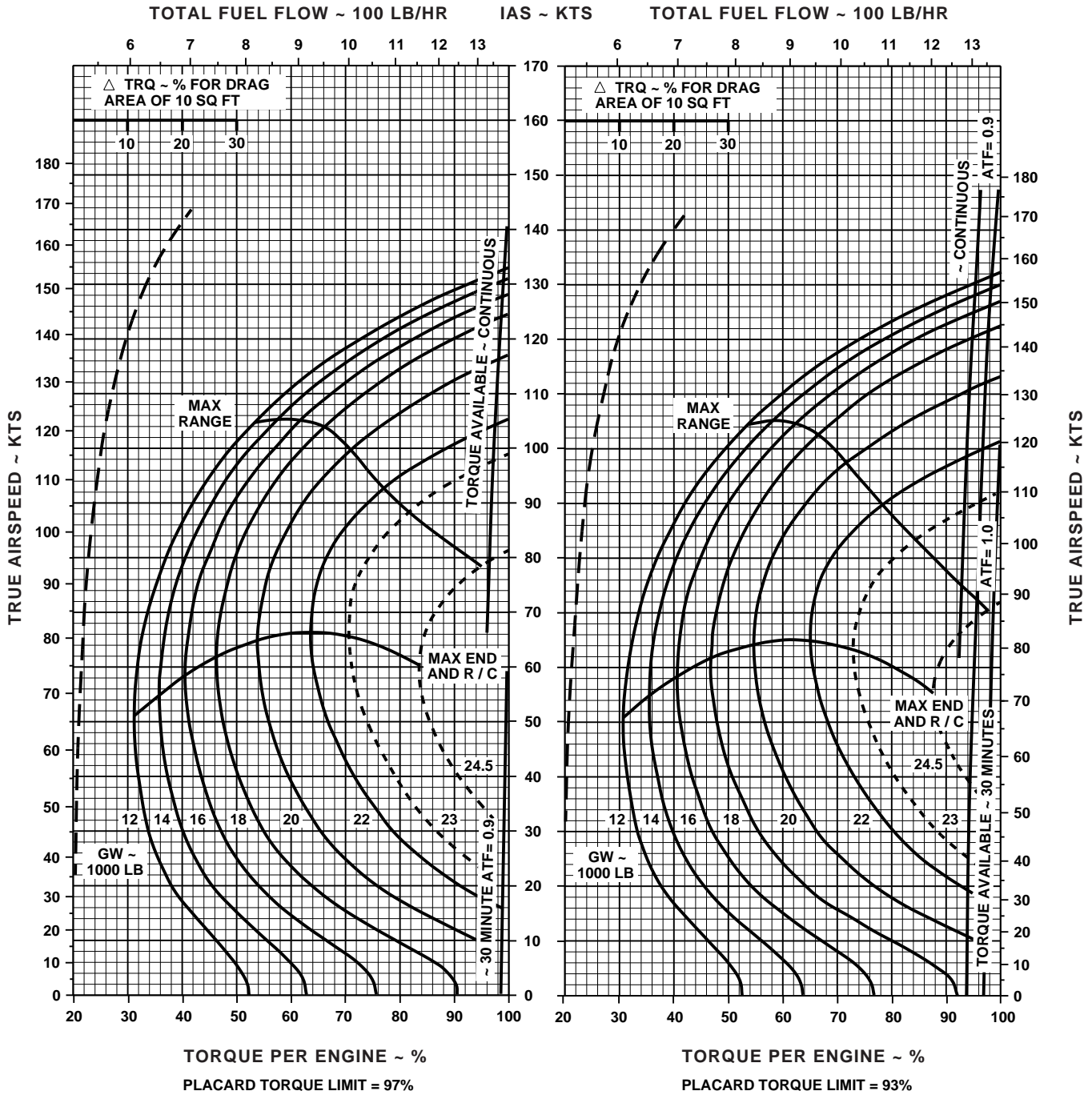

NOTE: SHORT DASH LINES: FERRY MISSION ONLY
 DATA BASE: FLIGHT TEST

AA1012_3
 SA

Figure 7A-18. Cruise High Drag - Pressure Altitude 8,000 Feet (Sheet 3 of 6)

CRUISE

PRESS ALT: 8000 FT

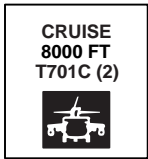

10°C

20°C

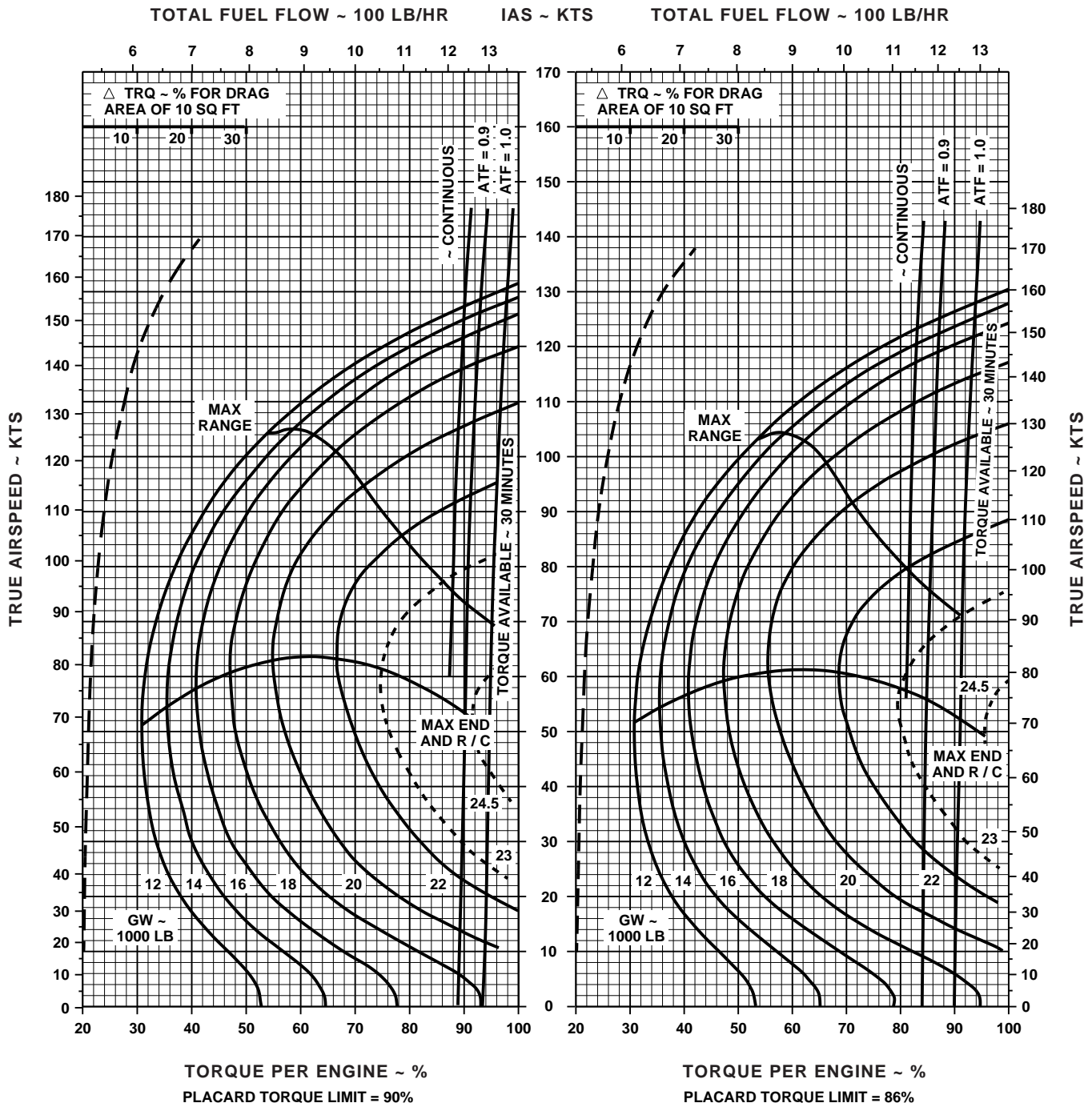

NOTE: SHORT DASH LINES: FERRY MISSION ONLY
 DATA BASE: FLIGHT TEST

AA1012_4
 SA

Figure 7A-18. Cruise High Drag - Pressure Altitude 8,000 Feet (Sheet 4 of 6)

CRUISE

PRESS ALT: 8000 FT

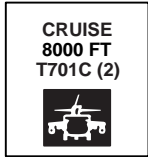

30°C

40°C

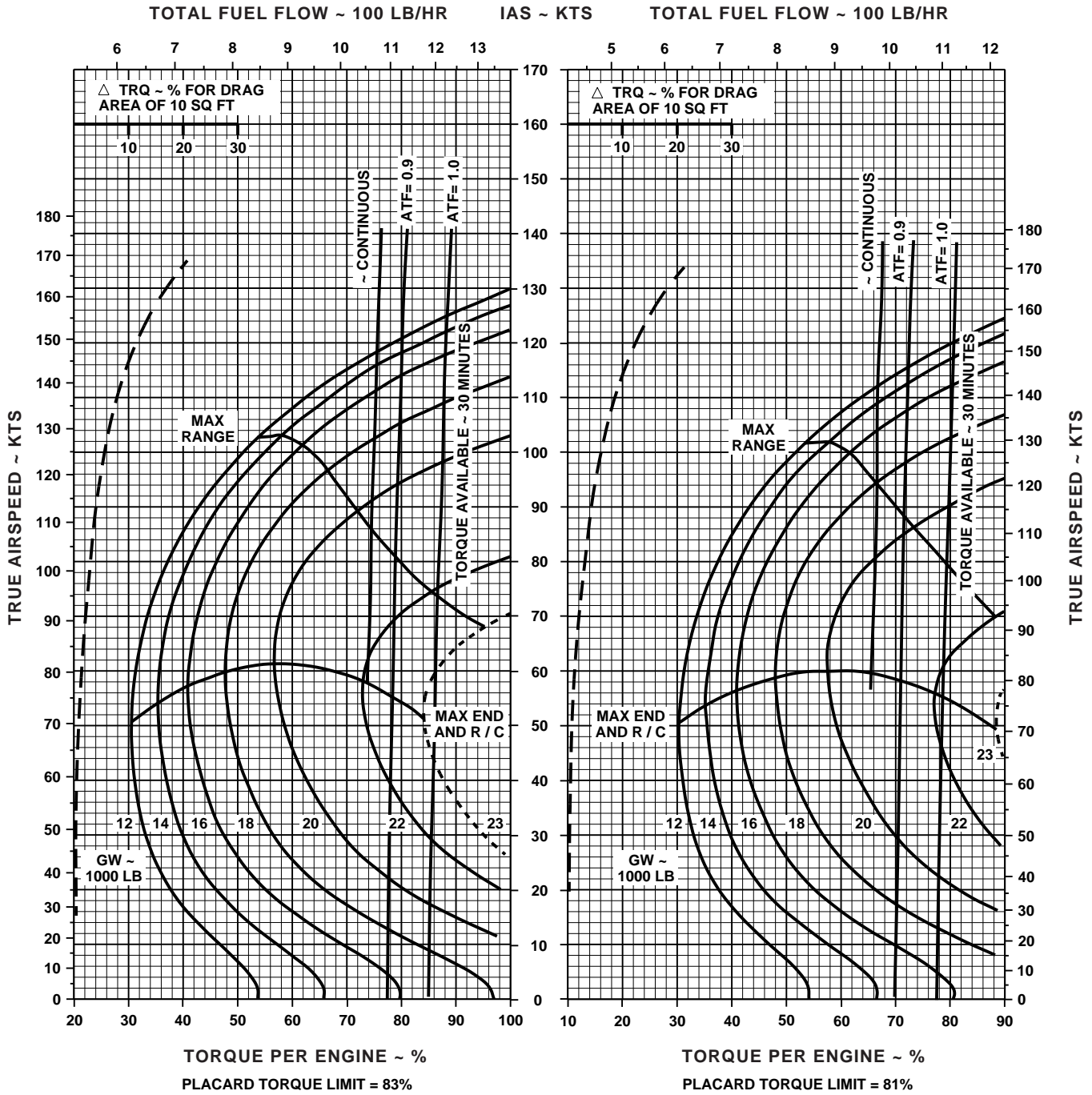

NOTE: SHORT DASH LINES: FERRY MISSION ONLY
 DATA BASE: FLIGHT TEST

AA1012.5
 SA

Figure 7A-18. Cruise High Drag - Pressure Altitude 8,000 Feet (Sheet 5 of 6)

CRUISE

PRESS ALT: 8000 FT

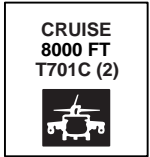

50°C

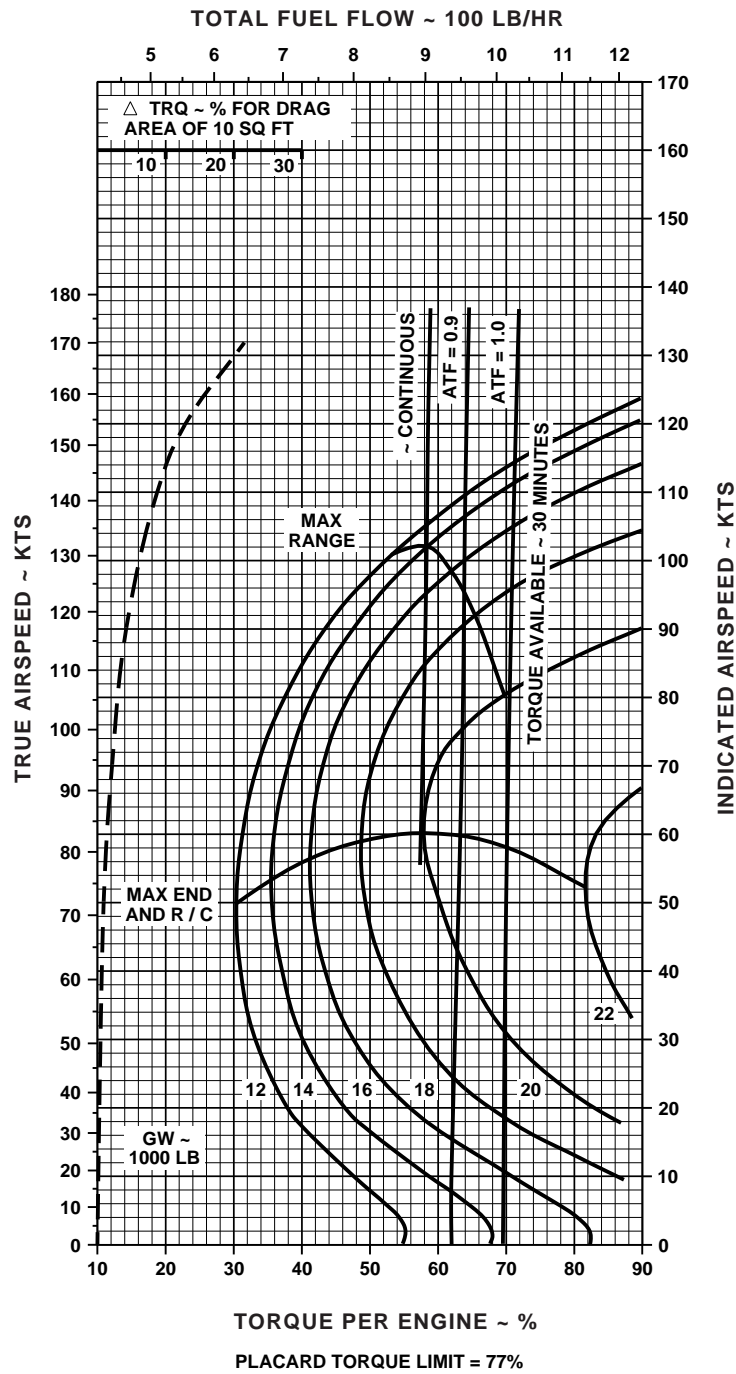

NOTE: SHORT DASH LINES: FERRY MISSION ONLY
DATA BASIS: FLIGHT TEST

AA2102_6
SA

Figure 7A.18 Cruise High Drag - Pressure Altitude 8,000 Feet (Sheet 6 of 6)

CRUISE

CLEAN CONFIGURATION

PRESS ALT: 10,000 FT

CRUISE
10,000 FT
T701C (2)

-50°C

-40°C

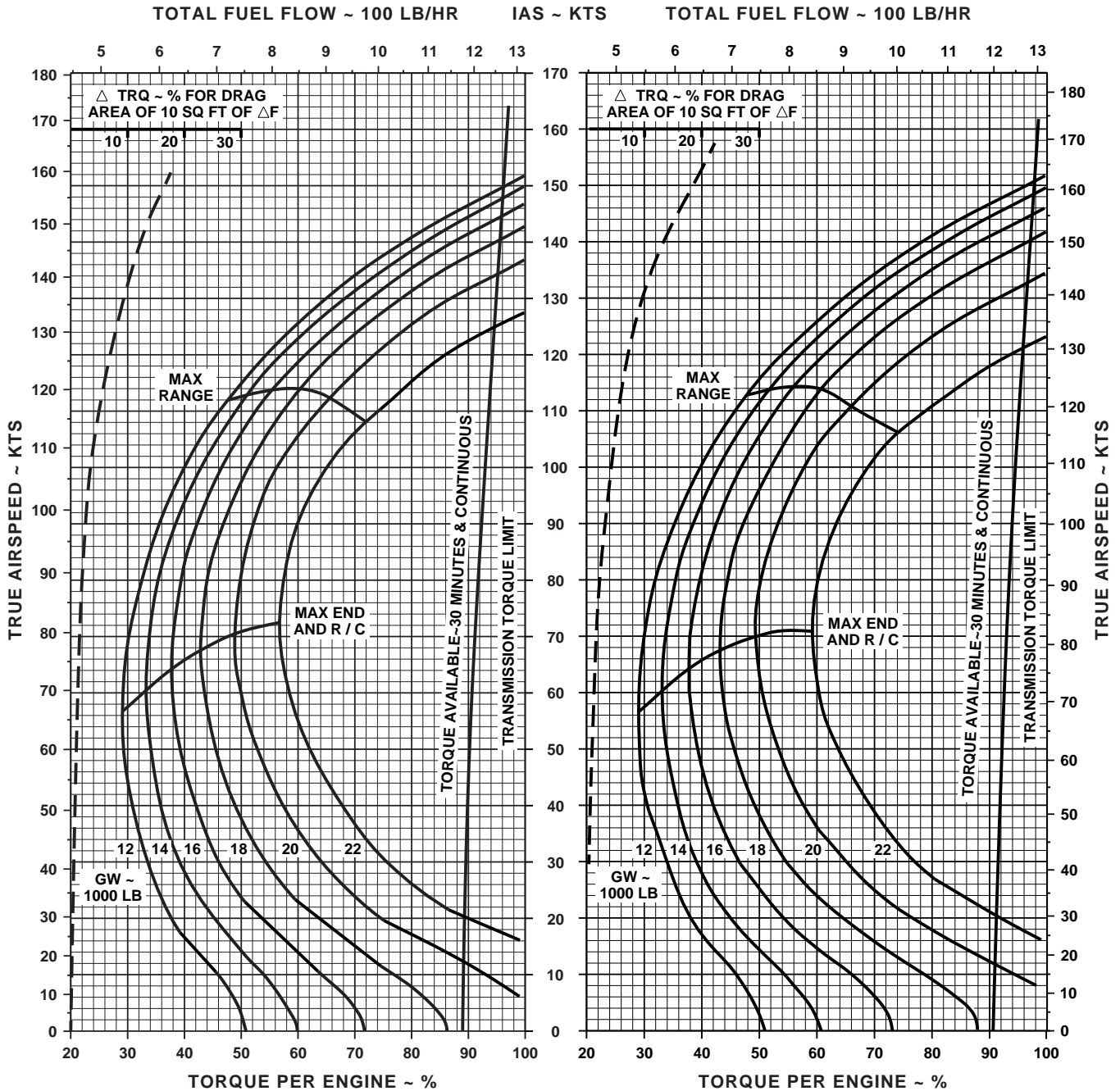

DATA BASE: FLIGHT TEST

AA1013_1
SA

Figure 7A-19. Cruise - Pressure Altitude 10,000 Feet (Sheet 1 of 5)

CRUISE

CLEAN CONFIGURATION

PRESS ALT: 10,000 FT

CRUISE
10,000 FT
T701C (2)

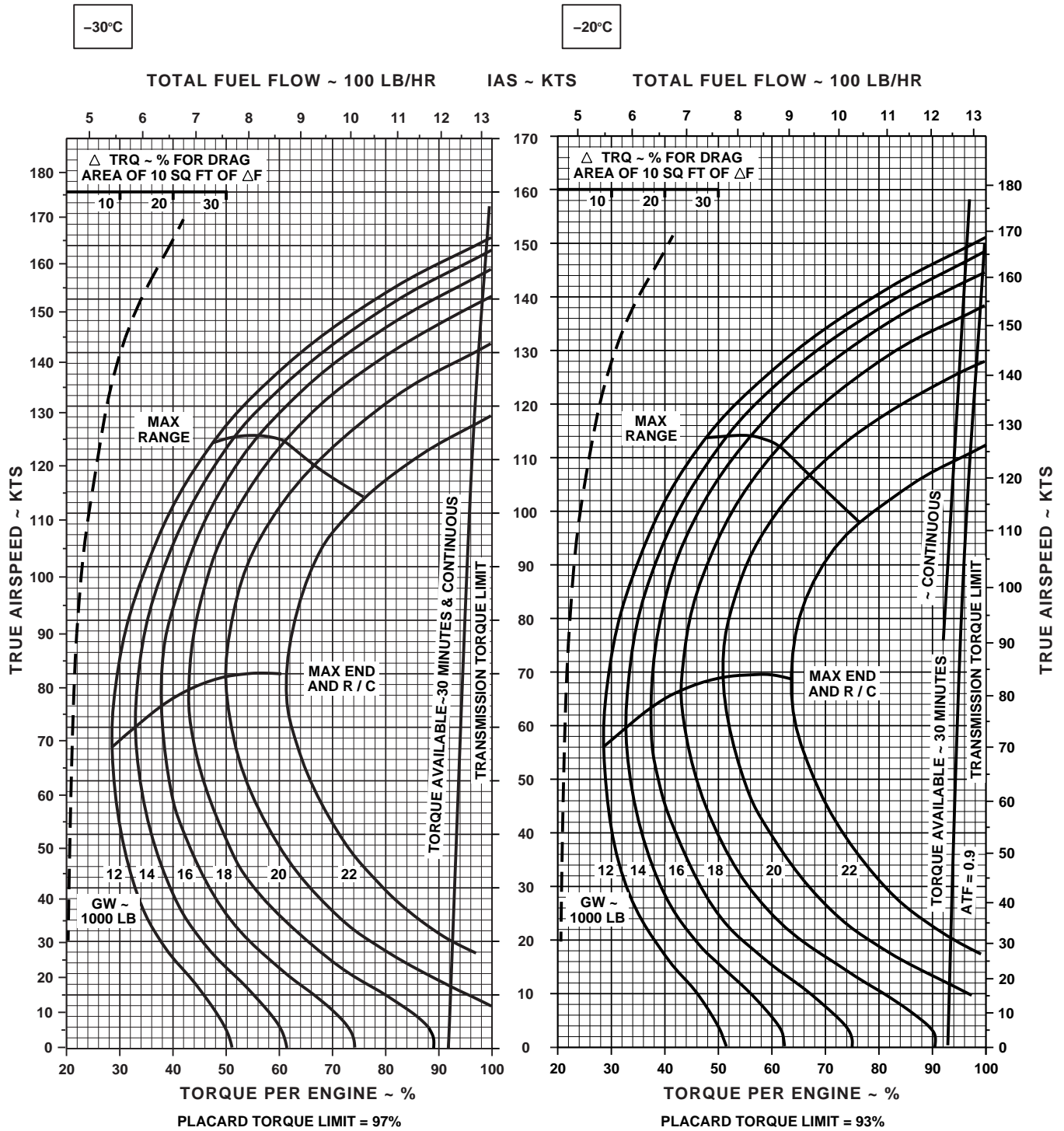

DATA BASE: FLIGHT TEST

AA1013_2
SA

Figure 7A-19. Cruise - Pressure Altitude 10,000 Feet (Sheet 2 of 5)

CRUISE

CLEAN CONFIGURATION

PRESS ALT: 10,000 FT

CRUISE
10,000 FT
T701C (2)

-10°C

0°C

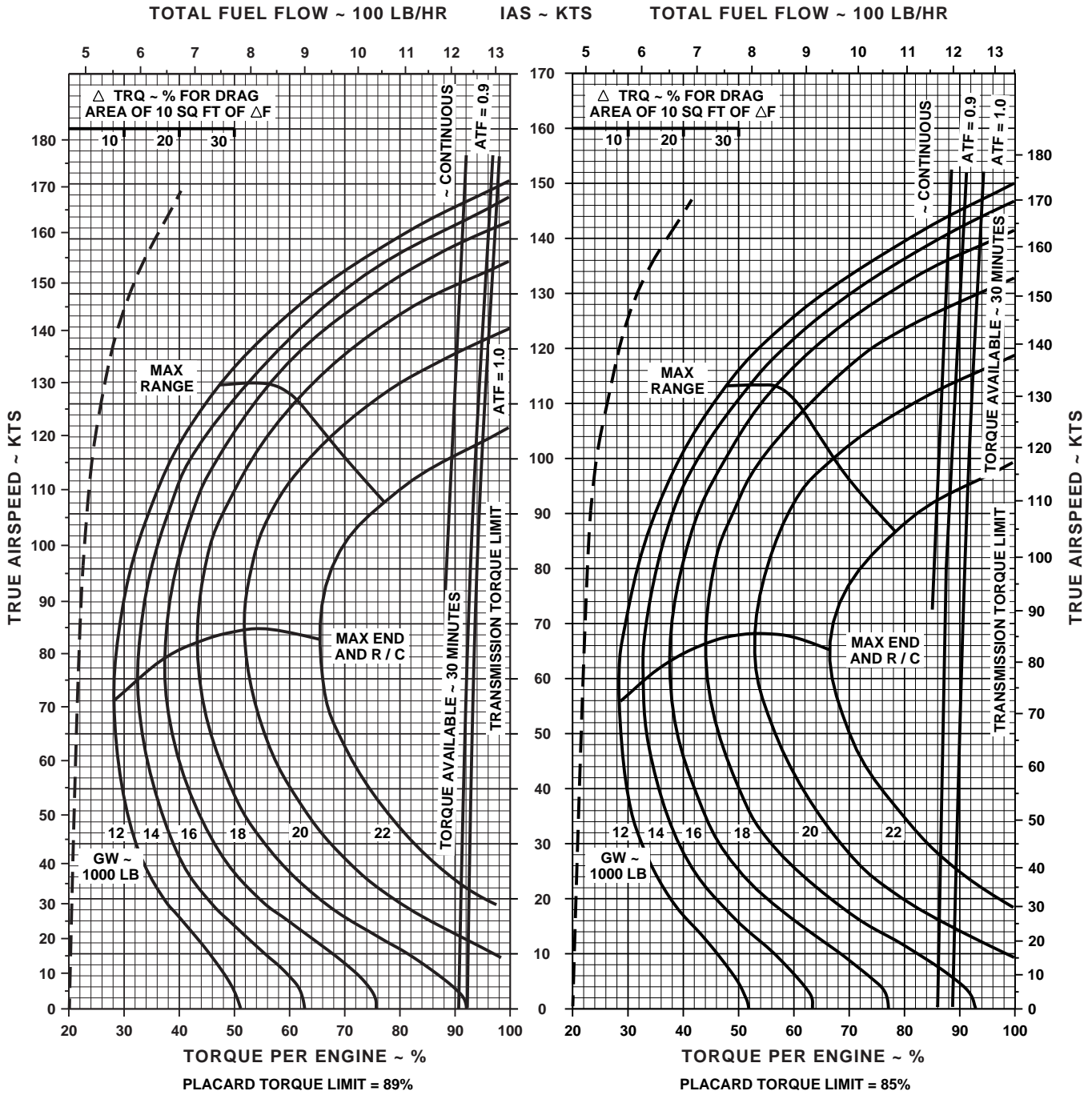

DATA BASE: FLIGHT TEST

AA1013_3
SA

Figure 7A-19. Cruise - Pressure Altitude 10,000 Feet (Sheet 3 of 5)

CRUISE

CLEAN CONFIGURATION

PRESS ALT: 10,000 FT

CRUISE
10,000 FT
T701C (2)

10°C

20°C

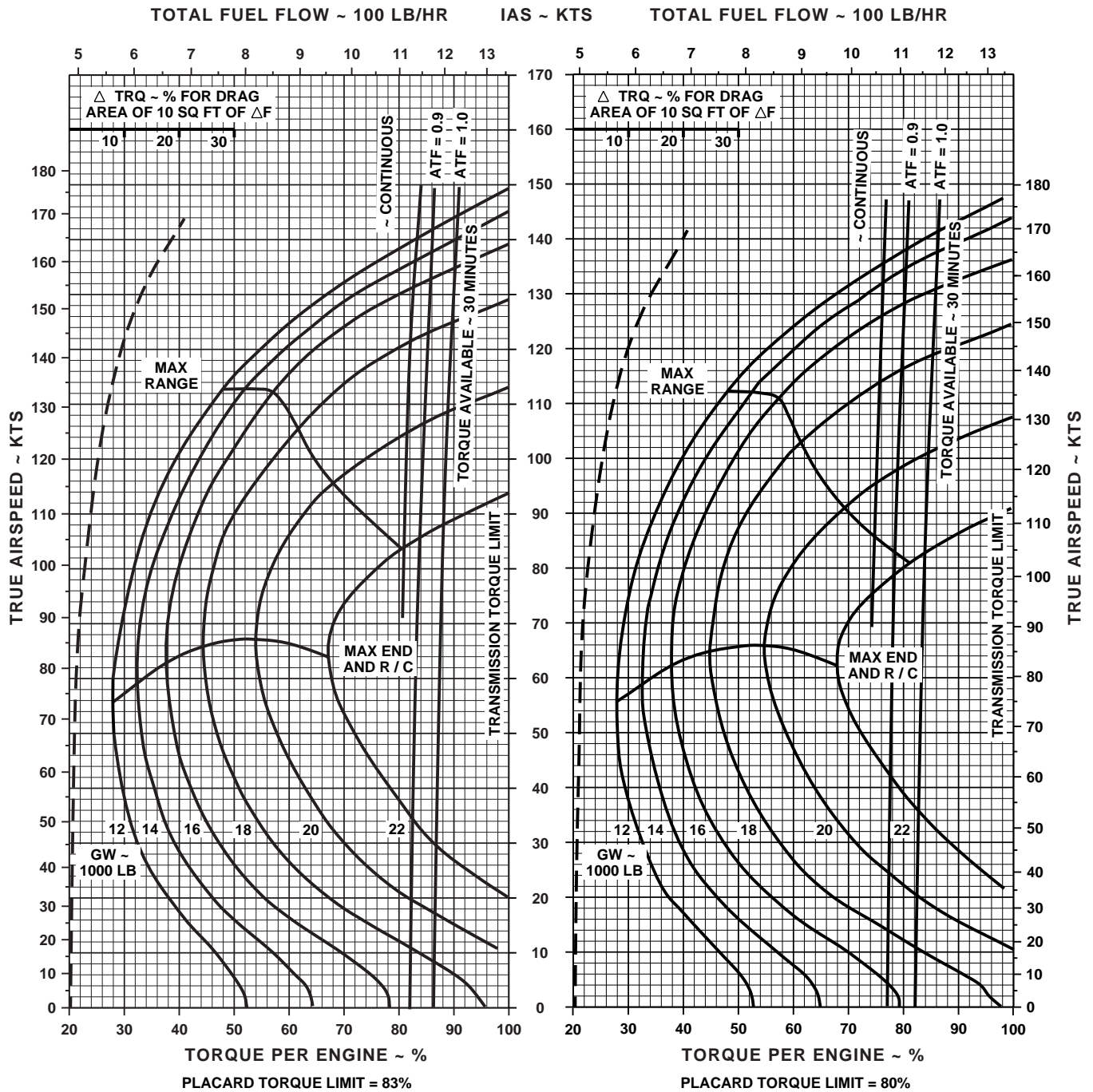

DATA BASE: FLIGHT TEST

AA1013_4
SA

Figure 7A-19. Cruise - Pressure Altitude 10,000 Feet (Sheet 4 of 5)

CRUISE

CLEAN CONFIGURATION

PRESS ALT: 10,000 FT

CRUISE
10,000 FT
T701C (2)

30°C

40°C

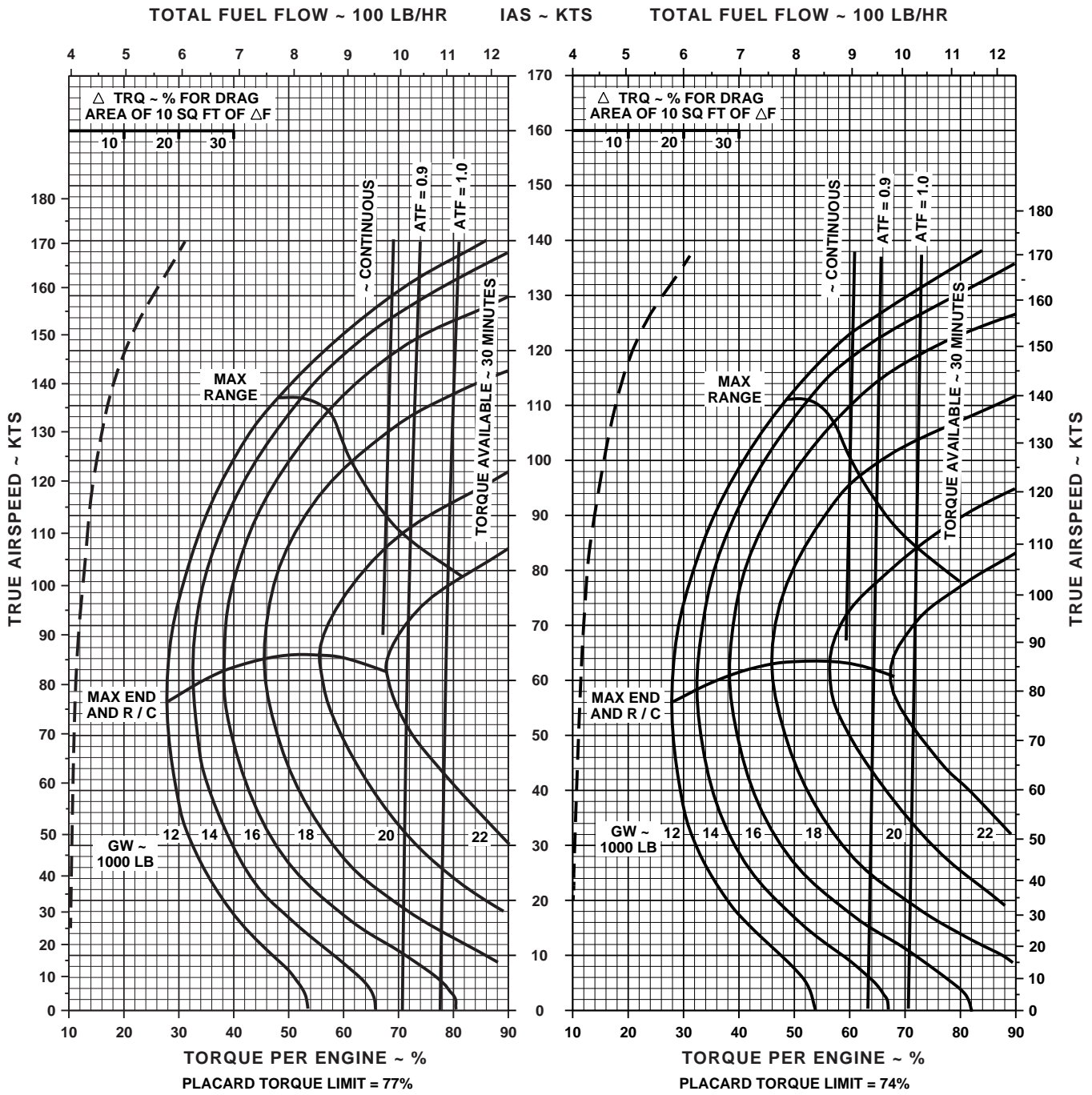

DATA BASE: FLIGHT TEST

AA1013_5
SA

Figure 7A-19. Cruise - Pressure Altitude 10,000 Feet (Sheet 5 of 5)

CRUISE

PRESS ALT: 10000 FT

CRUISE
10000 FT
T701C (2)



-50°C

-40°C

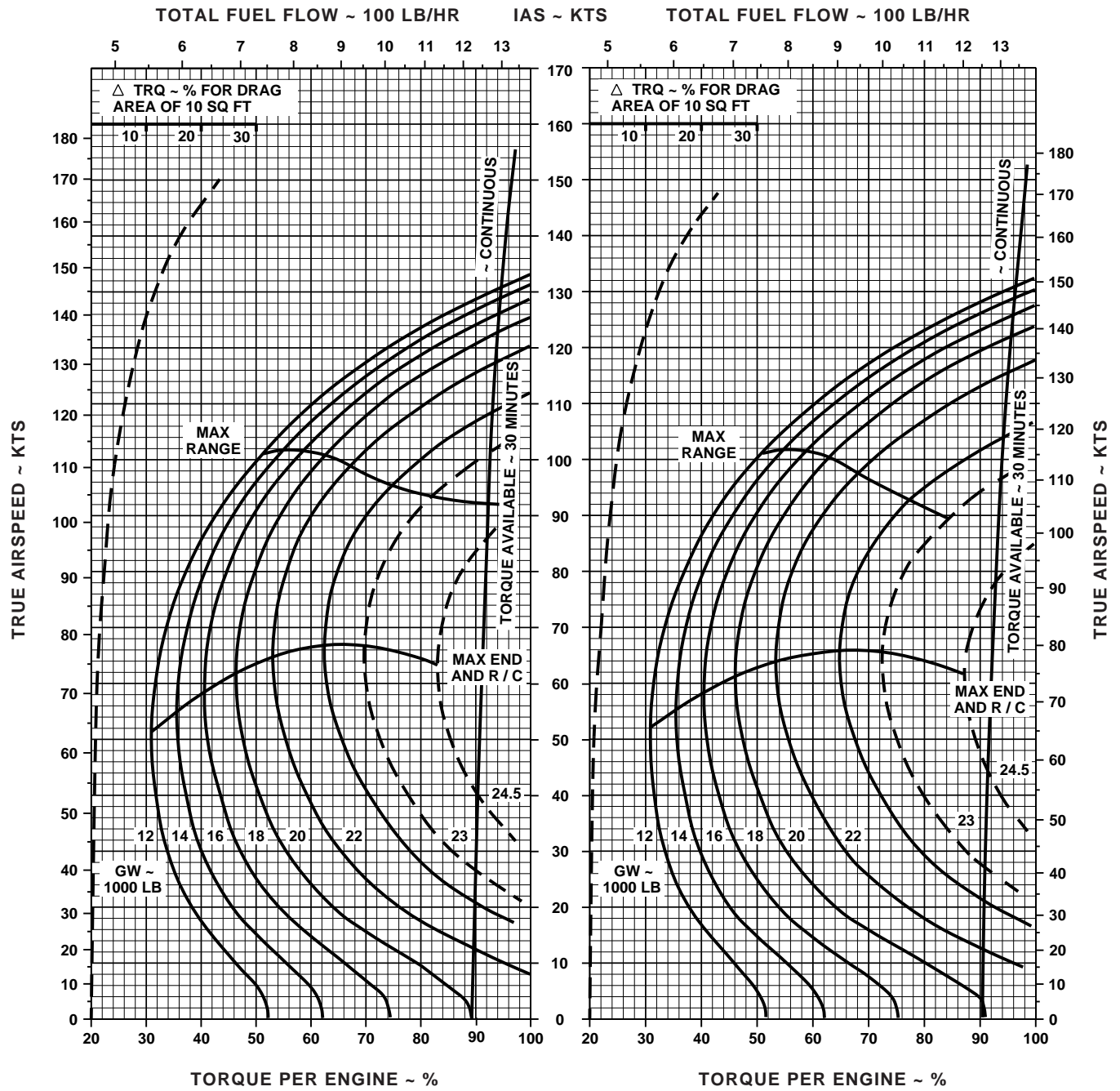

NOTE: SHORT DASH LINES: FERRY MISSION ONLY
DATA BASE: FLIGHT TEST

AA1014_1
SA

Figure 7A-20. Cruise High Drag - Pressure Altitude 10,000 Feet (Sheet 1 of 5)

CRUISE

PRESS ALT: 10000 FT

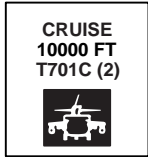

-30°C

-20°C

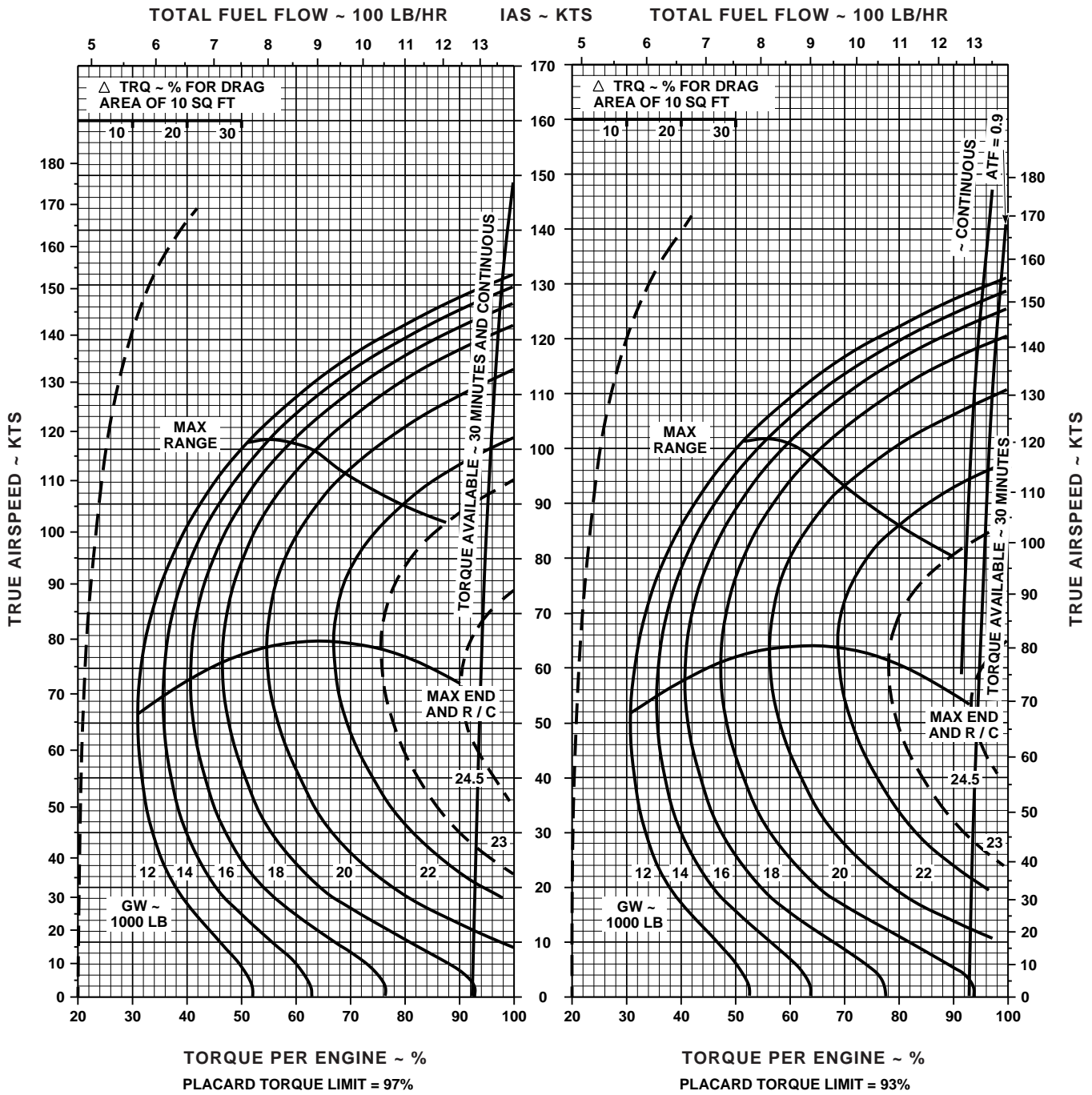
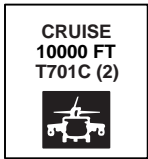

Figure 7A-20. Cruise High Drag - Pressure Altitude 10,000 Feet (Sheet 2 of 5)

CRUISE

PRESS ALT: 10000 FT



-10°C

0°C

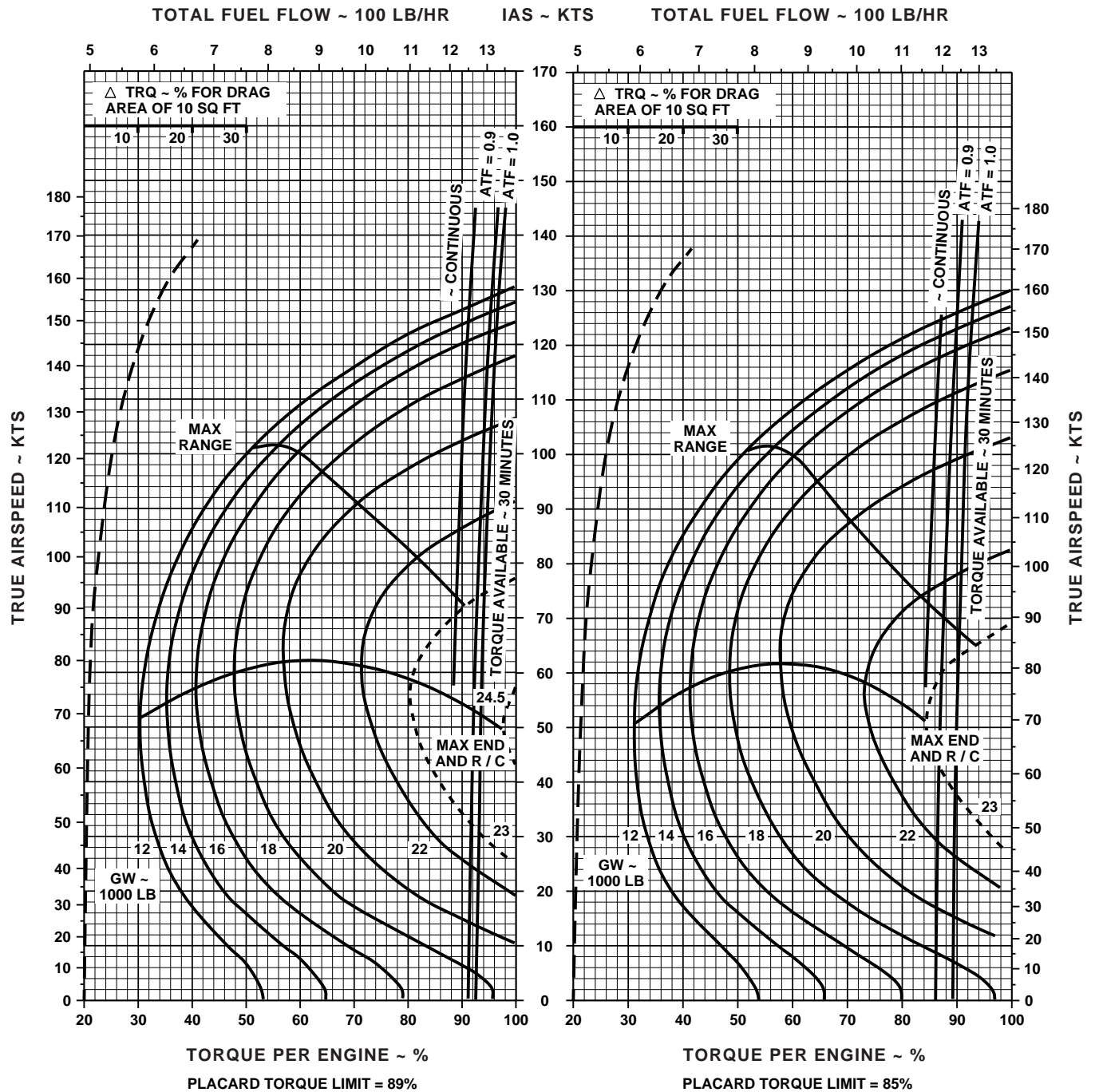

NOTE: SHORT DASH LINES: FERRY MISSION ONLY
 DATA BASE: FLIGHT TEST

AA1014_3
 SA

Figure 7A-20. Cruise High Drag - Pressure Altitude 10,000 Feet (Sheet 3 of 5)

CRUISE

PRESS ALT: 10000 FT

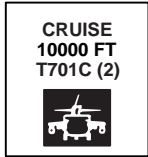

10°C

20°C

TOTAL FUEL FLOW ~ 100 LB/HR

IAS ~ KTS

TOTAL FUEL FLOW ~ 100 LB/HR

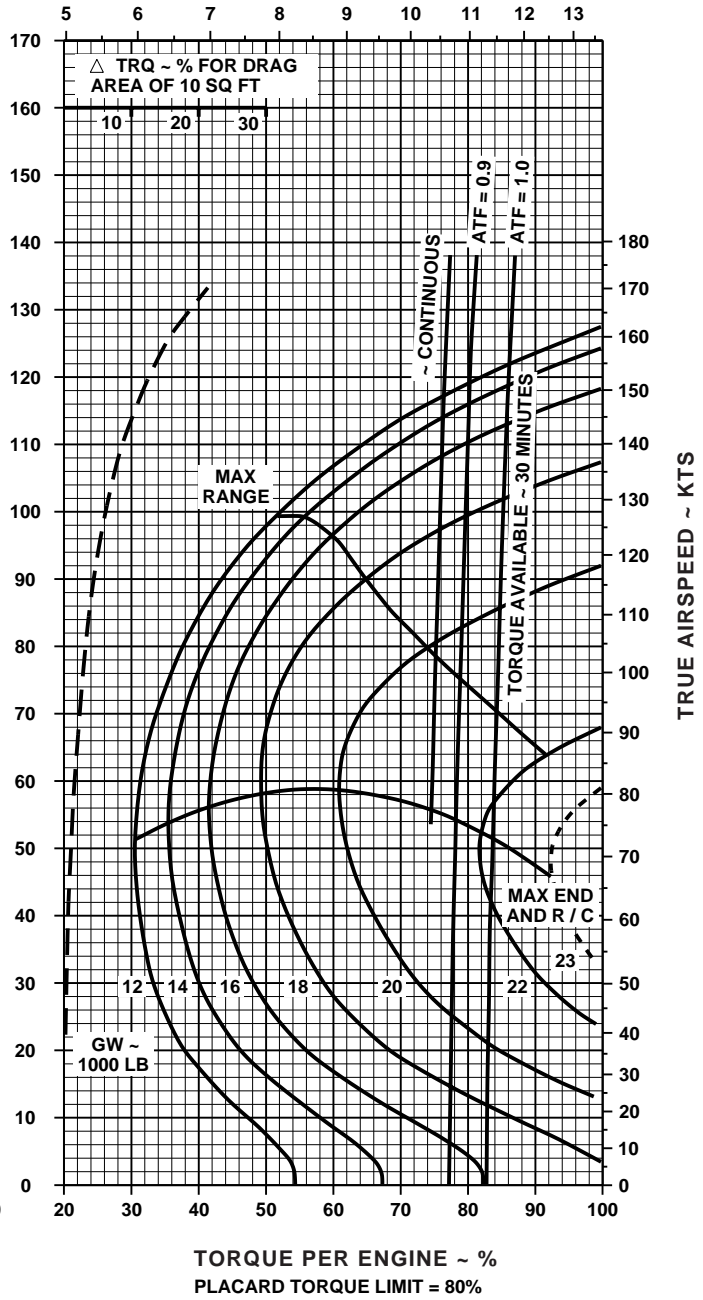
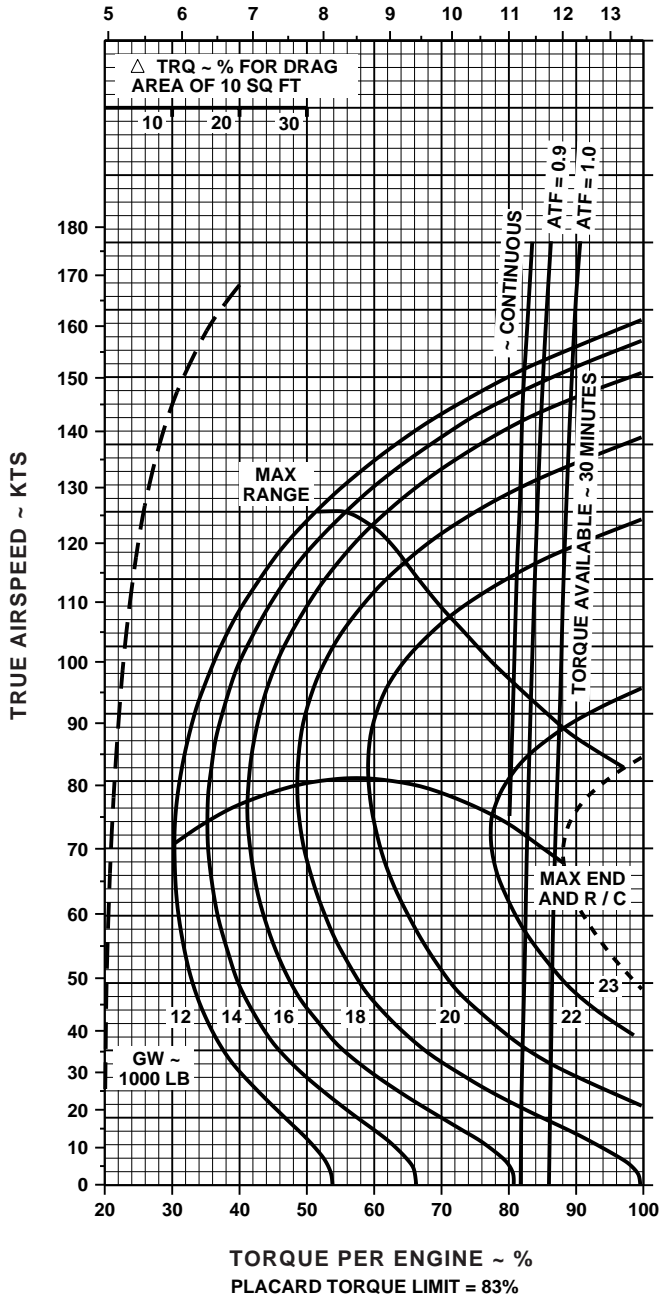

NOTE: SHORT DASH LINES: FERRY MISSION ONLY
 DATA BASE: FLIGHT TEST

AA1014_4
 SA

Figure 7A-20. Cruise High Drag - Pressure Altitude 10,000 Feet (Sheet 4 of 5)

CRUISE

PRESS ALT: 10000 FT

CRUISE
10000 FT
T701C (2)



30°C

40°C

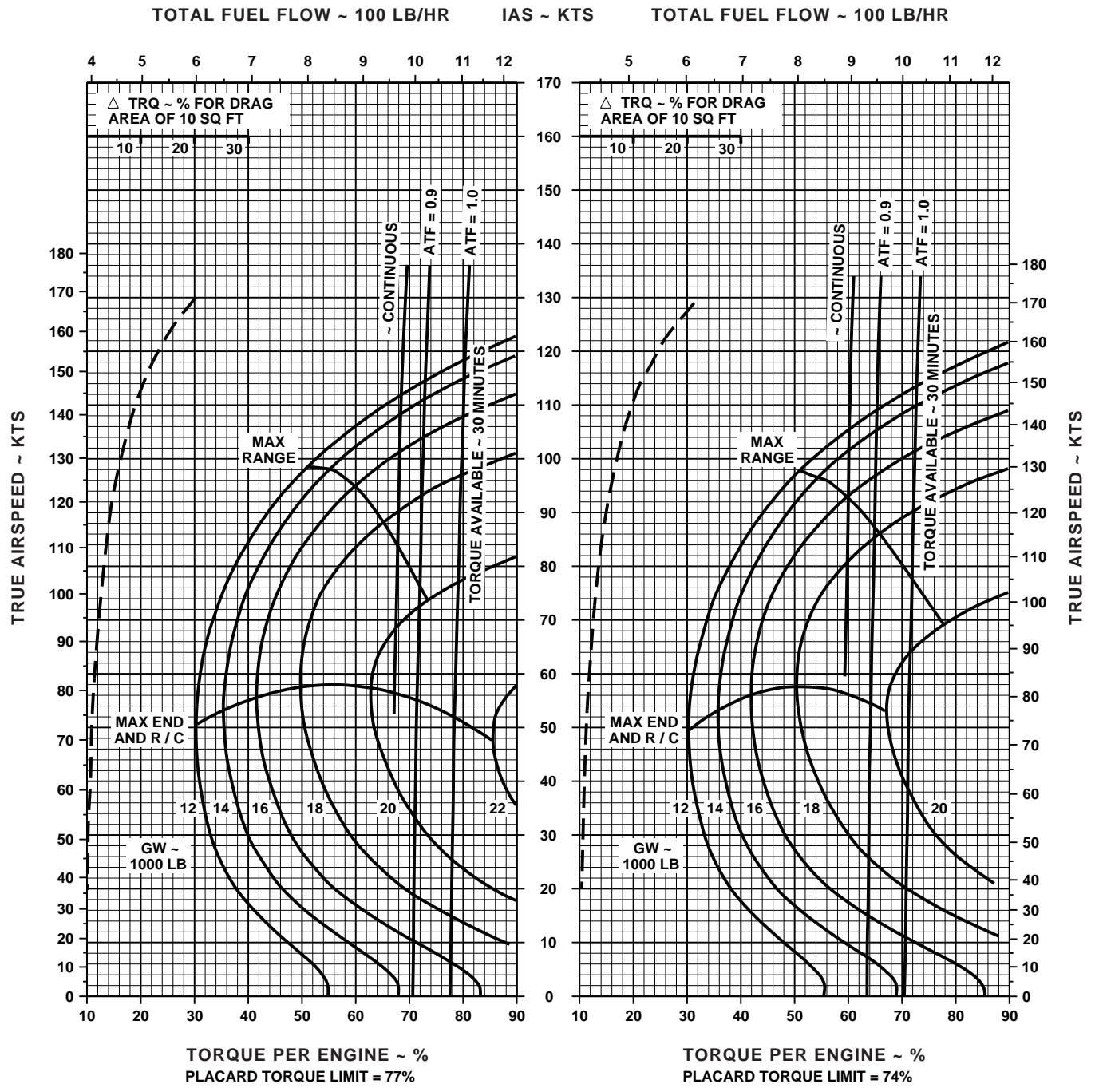

NOTE: SHORT DASH LINES: FERRY MISSION ONLY
DATA BASE: FLIGHT TEST

AA1014_5
SA

Figure 7A-20. Cruise High Drag - Pressure Altitude 10,000 Feet (Sheet 5 of 5)

CRUISE

CLEAN CONFIGURATION PRESS ALT: 12,000 FT

CRUISE
12,000 FT
T701C (2)

-50°C

-40°C

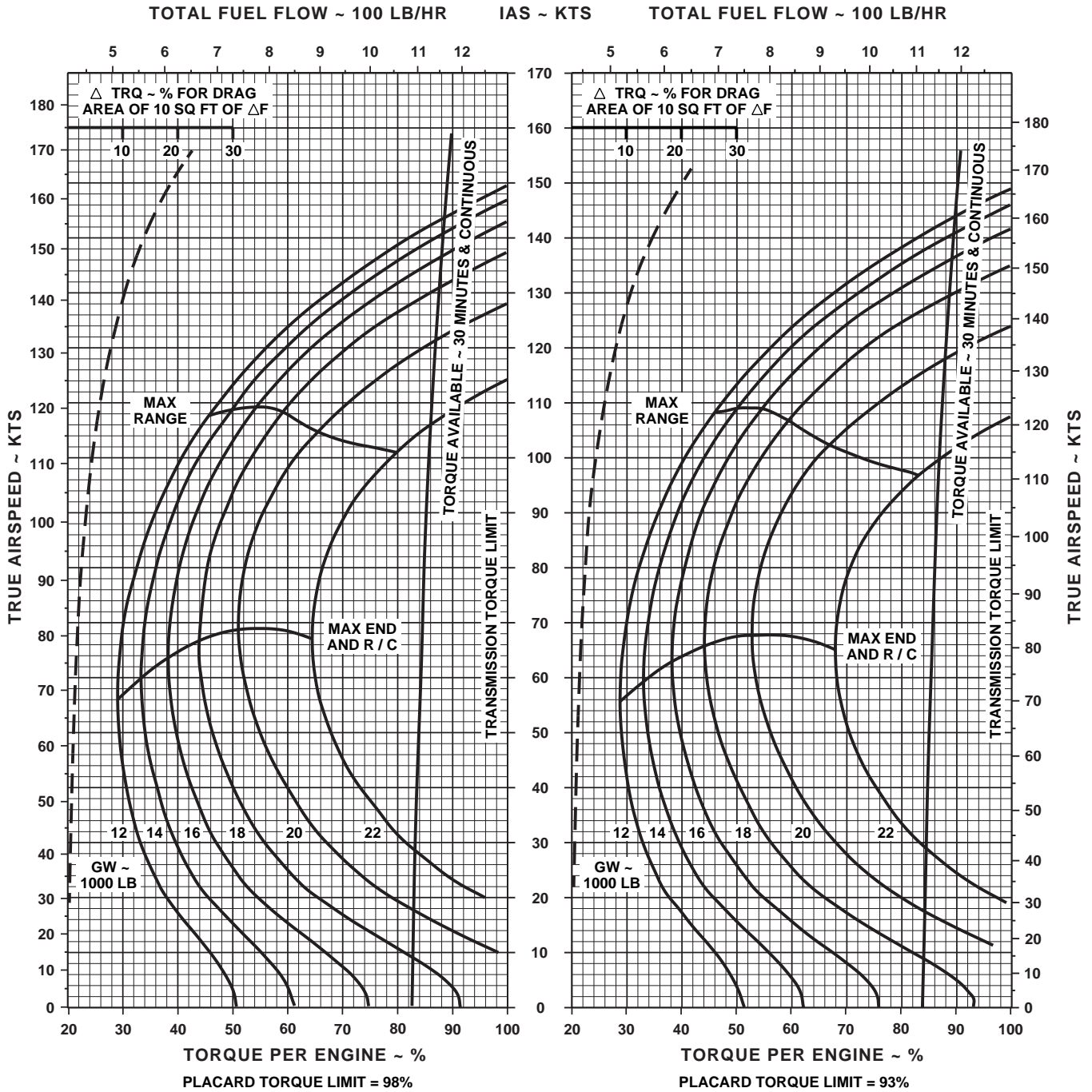

DATA BASE: FLIGHT TEST

AA1015_1
SA

Figure 7A-21. Cruise - Pressure Altitude 12,000 Feet (Sheet 1 of 5)

CRUISE

CLEAN CONFIGURATION

PRESS ALT: 12,000 FT

CRUISE
12,000 FT
T701C (2)

-30°C

-20°C

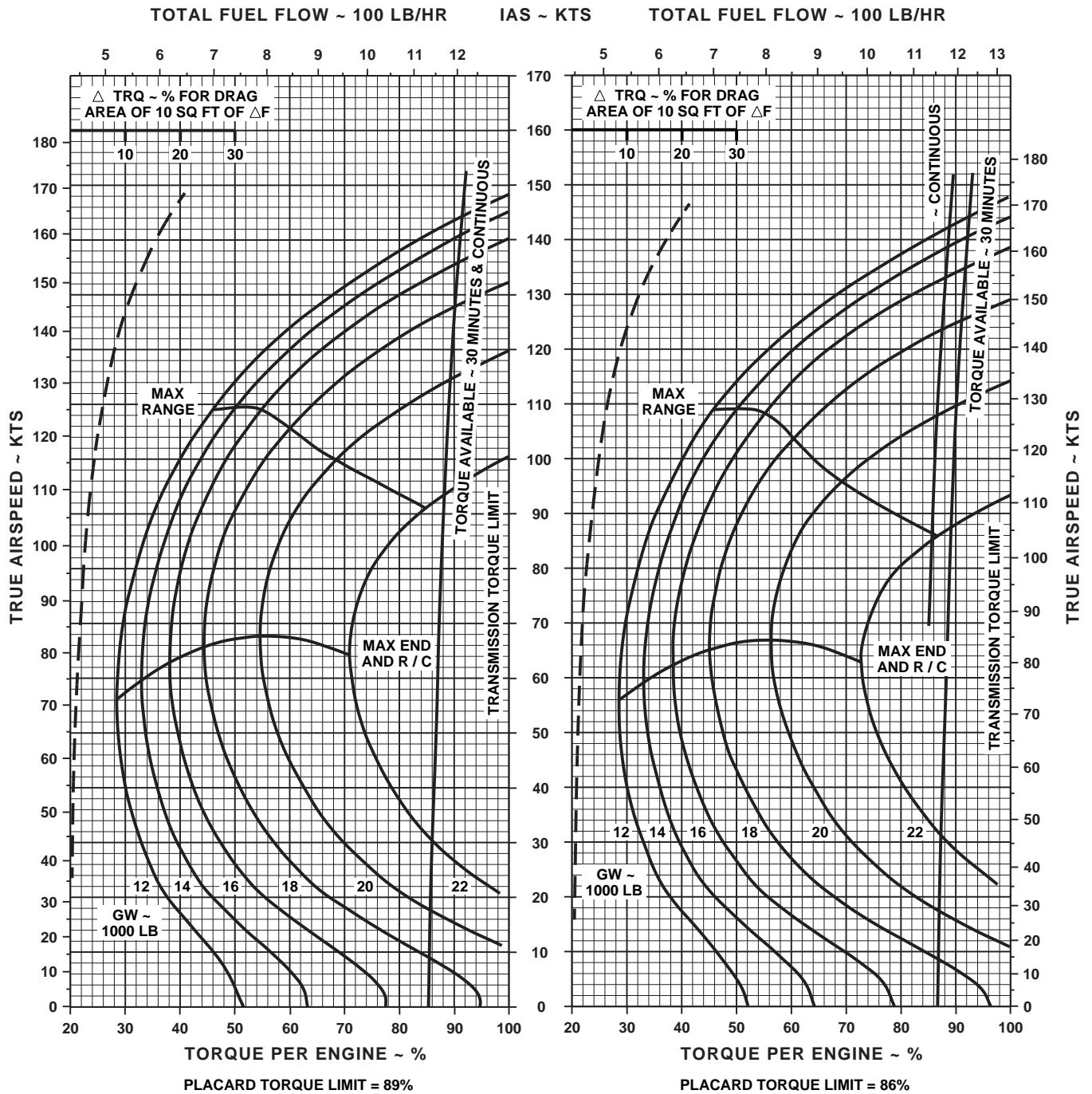

DATA BASE: FLIGHT TEST

AA1015_2
SA

Figure 7A-21. Cruise - Pressure Altitude 12,000 Feet (Sheet 2 of 5)

CRUISE

CLEAN CONFIGURATION PRESS ALT: 12,000 FT

CRUISE
12,000 FT
T701C (2)

-10°C

0°C

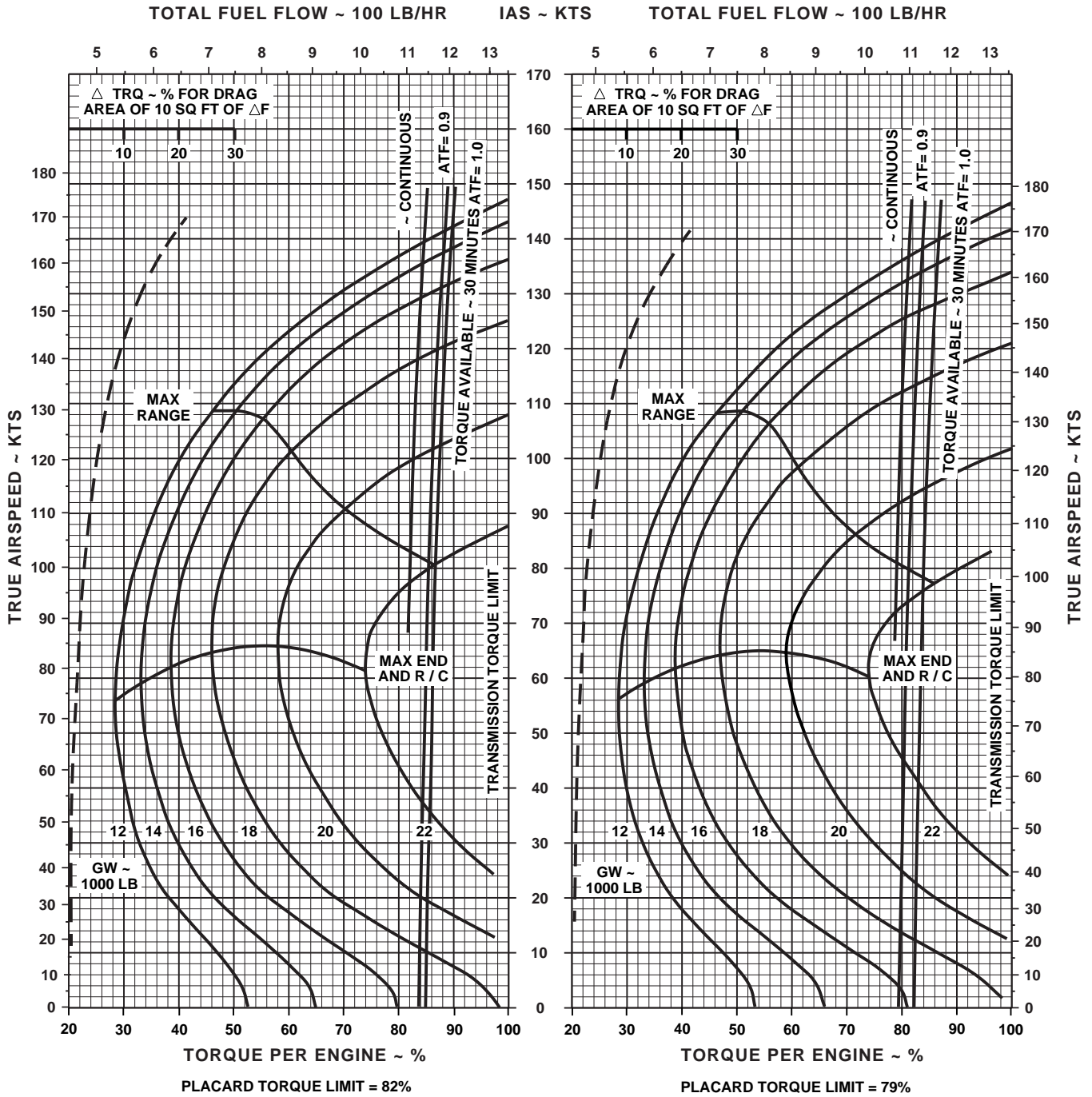

DATA BASE: FLIGHT TEST

AA1015_3
SA

Figure 7A-21. Cruise - Pressure Altitude 12,000 Feet (Sheet 3 of 5)

CRUISE

CLEAN CONFIGURATION

PRESS ALT: 12,000 FT

CRUISE
12,000 FT
T701C (2)

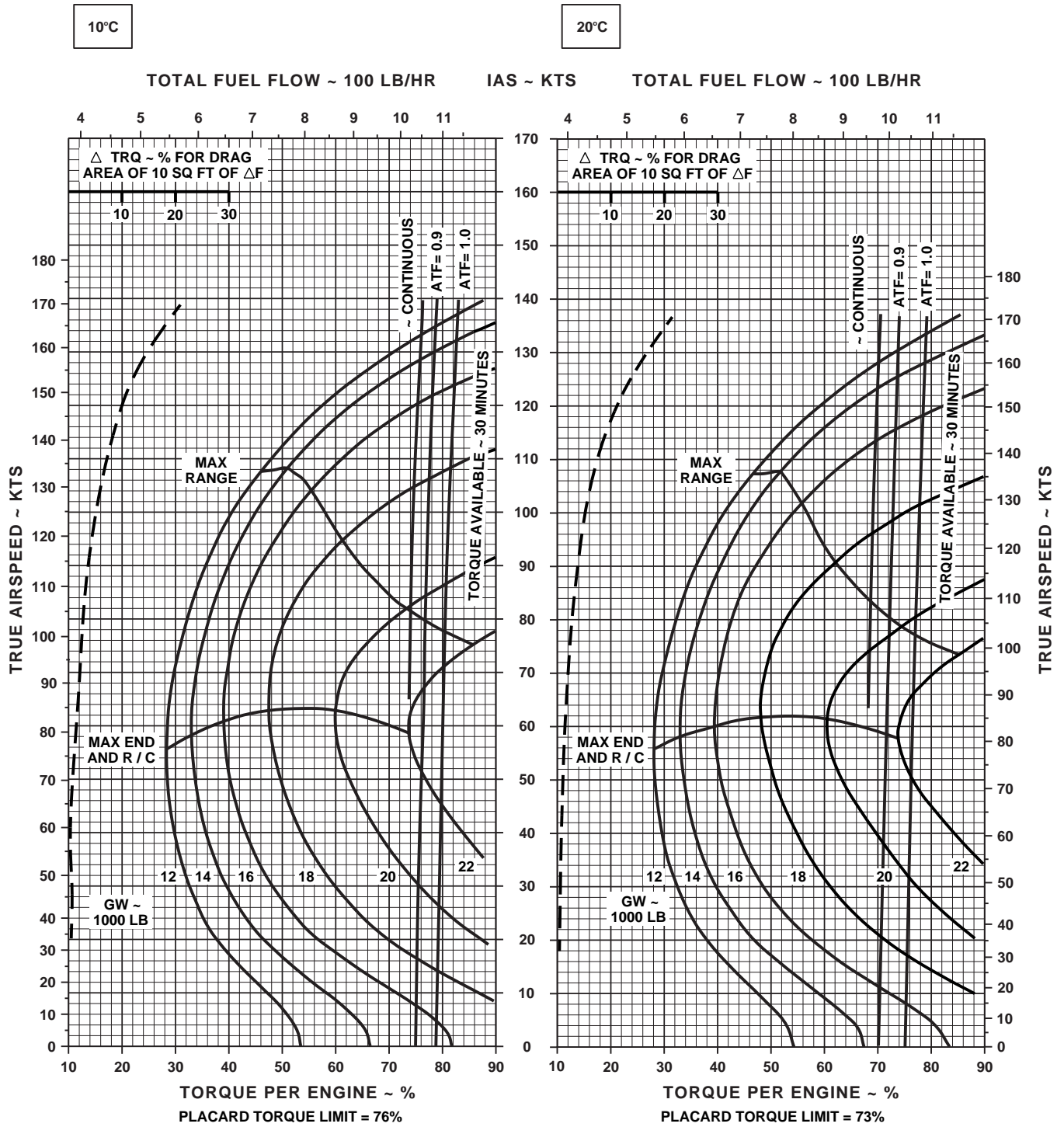

DATA BASE: FLIGHT TEST

AA1015_4
SA

Figure 7A-21. Cruise - Pressure Altitude 12,000 Feet (Sheet 4 of 5)

CRUISE

CLEAN CONFIGURATION

PRESS ALT: 12,000 FT

CRUISE
12,000 FT
T701C (2)

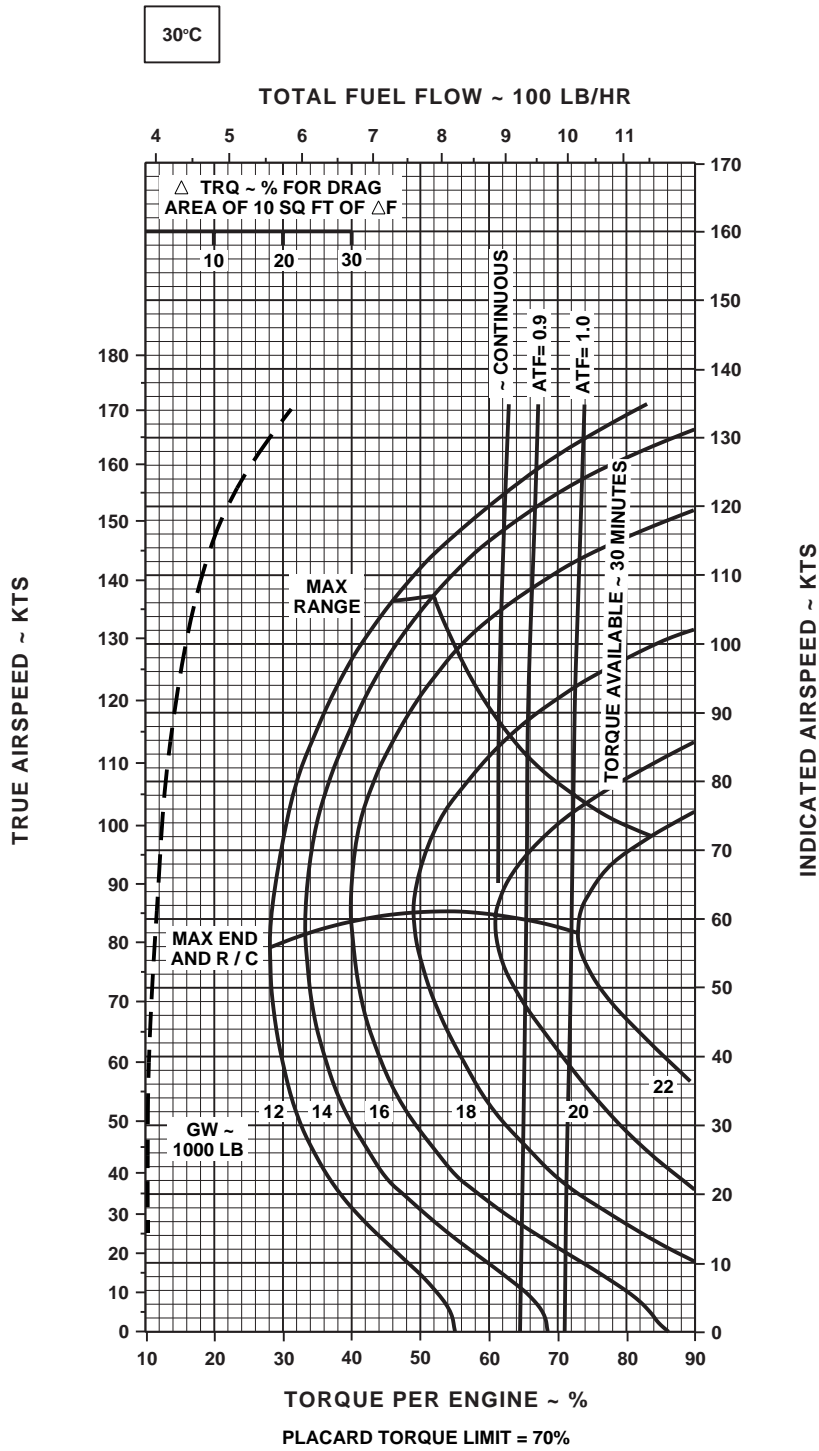

DATA BASE: FLIGHT TEST

AA1015_5
SA

Figure 7A-21. Cruise - Pressure Altitude 12,000 Feet (Sheet 5 of 5)

CRUISE

PRESS ALT: 12000 FT

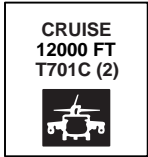

-50°C

-40°C

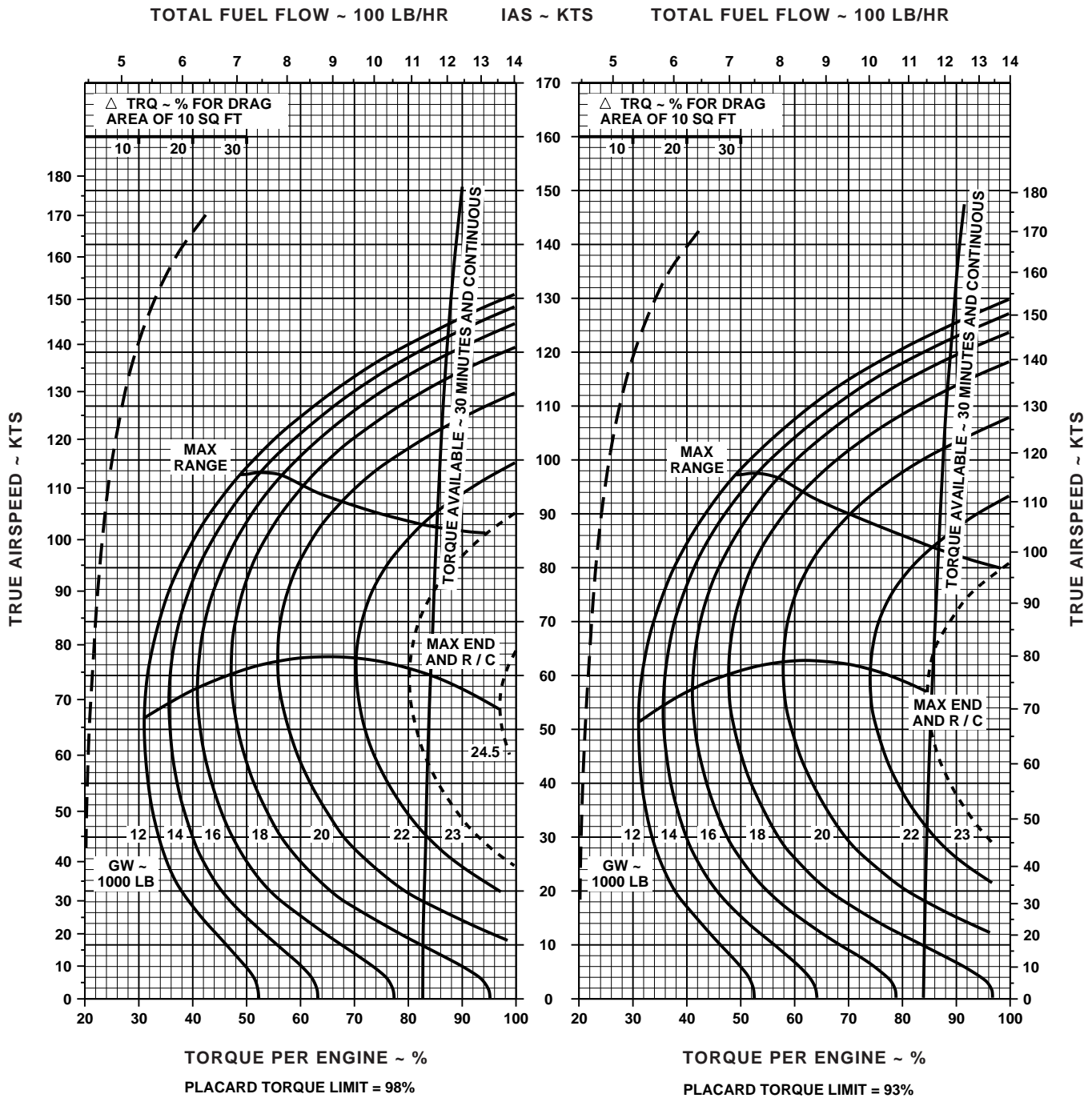

NOTE: SHORT DASH LINES: FERRY MISSION ONLY
 DATA BASE: FLIGHT TEST

AA1016_1
 SA

Figure 7A-22. Cruise High Drag - Pressure Altitude 12,000 Feet (Sheet 1 of 5)

CRUISE

PRESS ALT: 12000 FT

CRUISE
12000 FT
T701C (2)



-30°C

-20°C

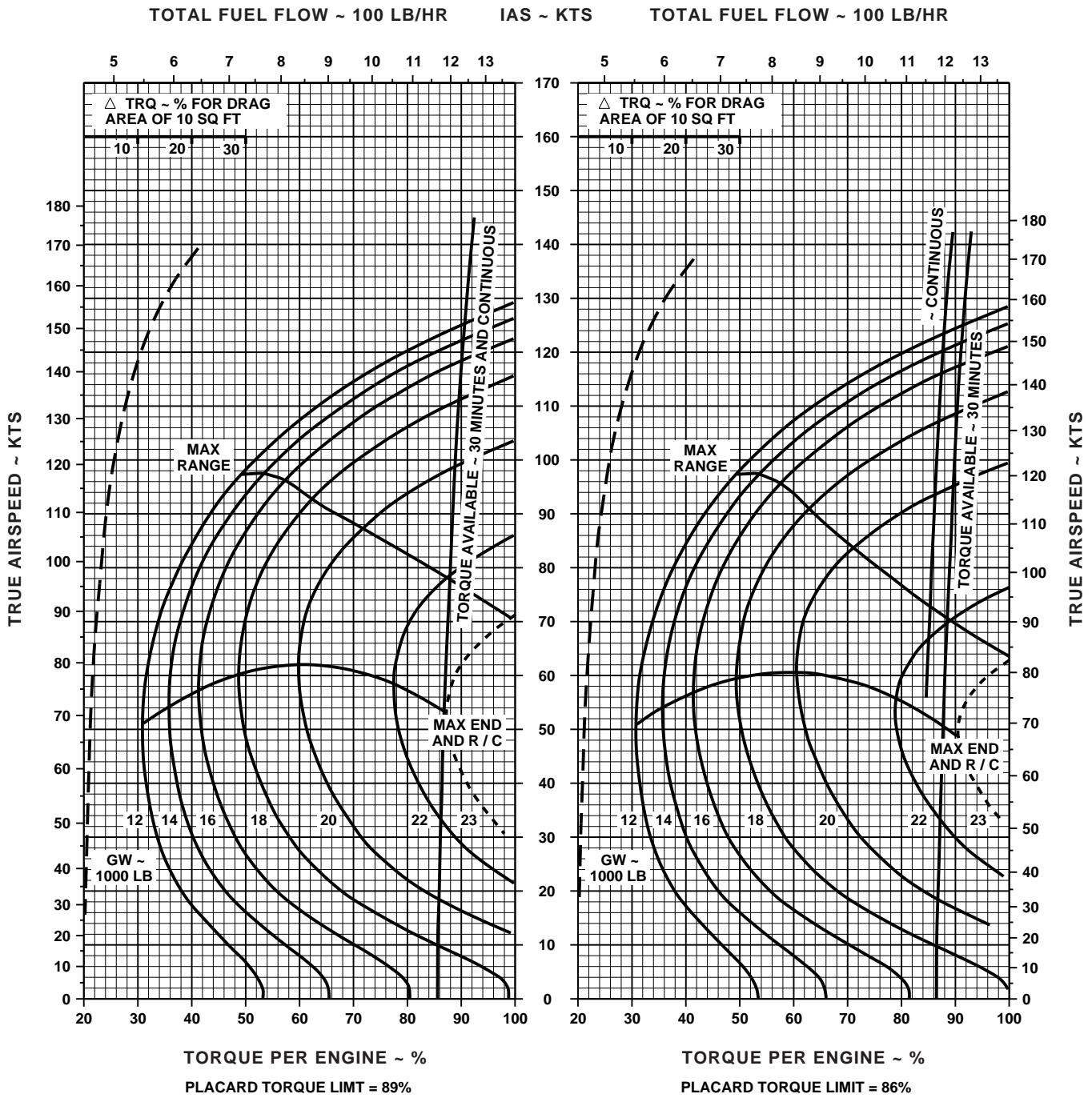

NOTE: SHORT DASH LINES: FERRY MISSION ONLY
DATA BASE: FLIGHT TEST

AA1016_2
SA

Figure 7A-22. Cruise High Drag - Pressure Altitude 12,000 Feet (Sheet 2 of 5)

CRUISE

PRESS ALT: 12000 FT

CRUISE
12000 FT
T701C (2)



-10°C

0°C

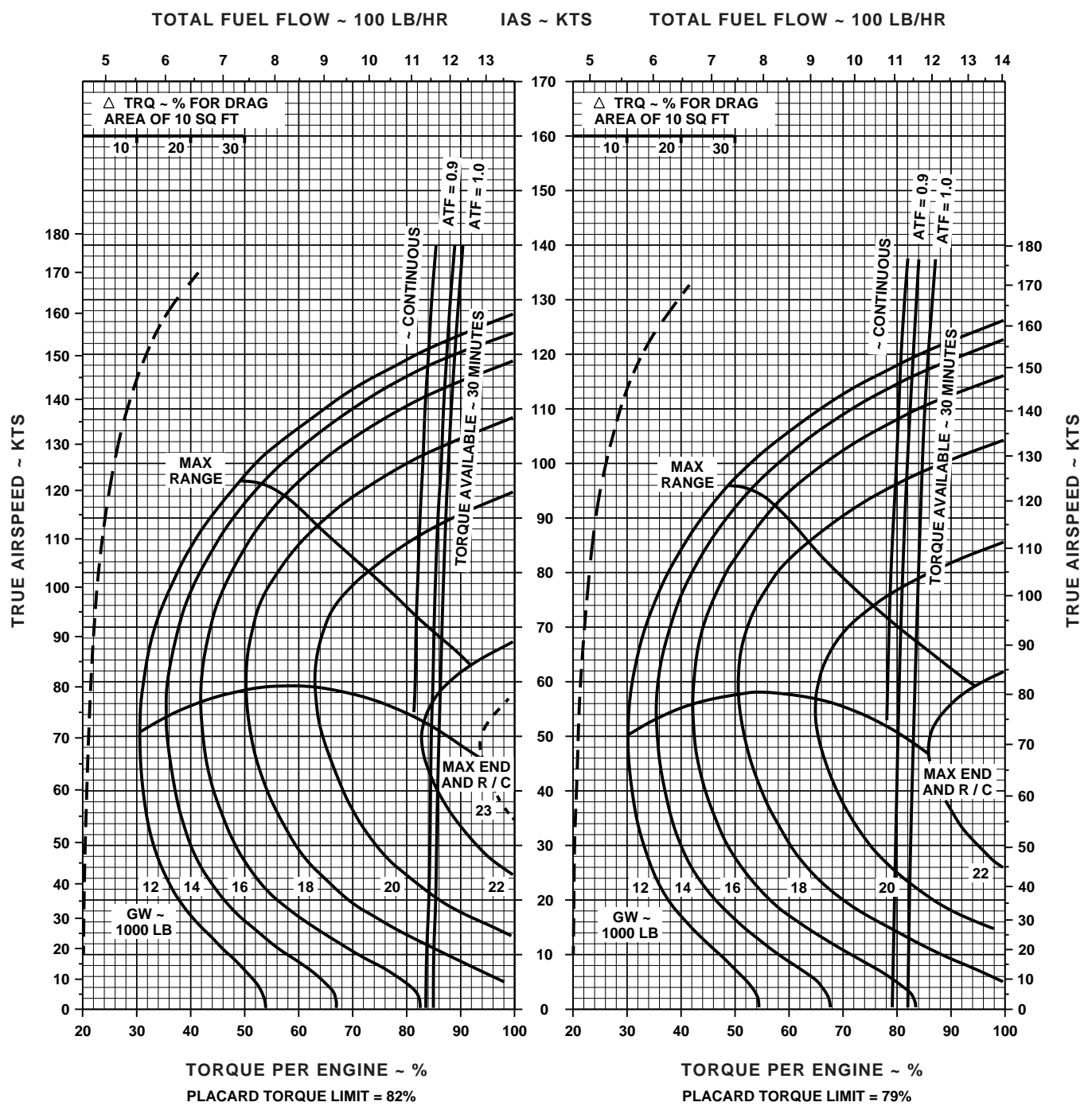
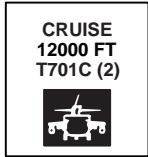

Figure 7A-22. Cruise High Drag - Pressure Altitude 12,000 Feet (Sheet 3 of 5)

AA1016_3
SA

CRUISE

PRESS ALT: 12000 FT



10°C

20°C

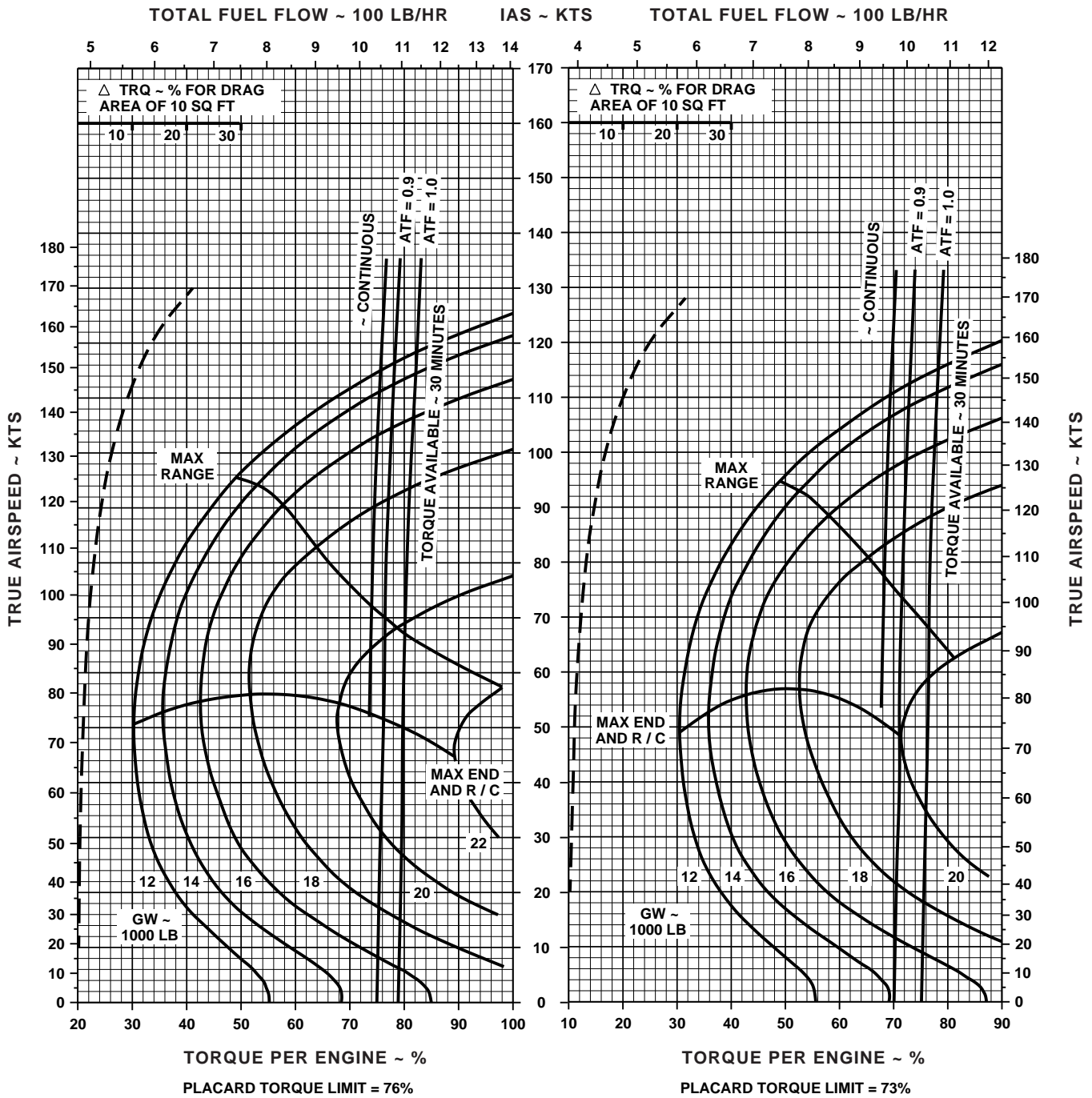

NOTE: SHORT DASH LINES: FERRY MISSION ONLY
 DATA BASE: FLIGHT TEST

AA1016_4
SA

Figure 7A-22. Cruise High Drag - Pressure Altitude 12,000 Feet (Sheet 4 of 5)

CRUISE

PRESS ALT: 12000 FT

30°C

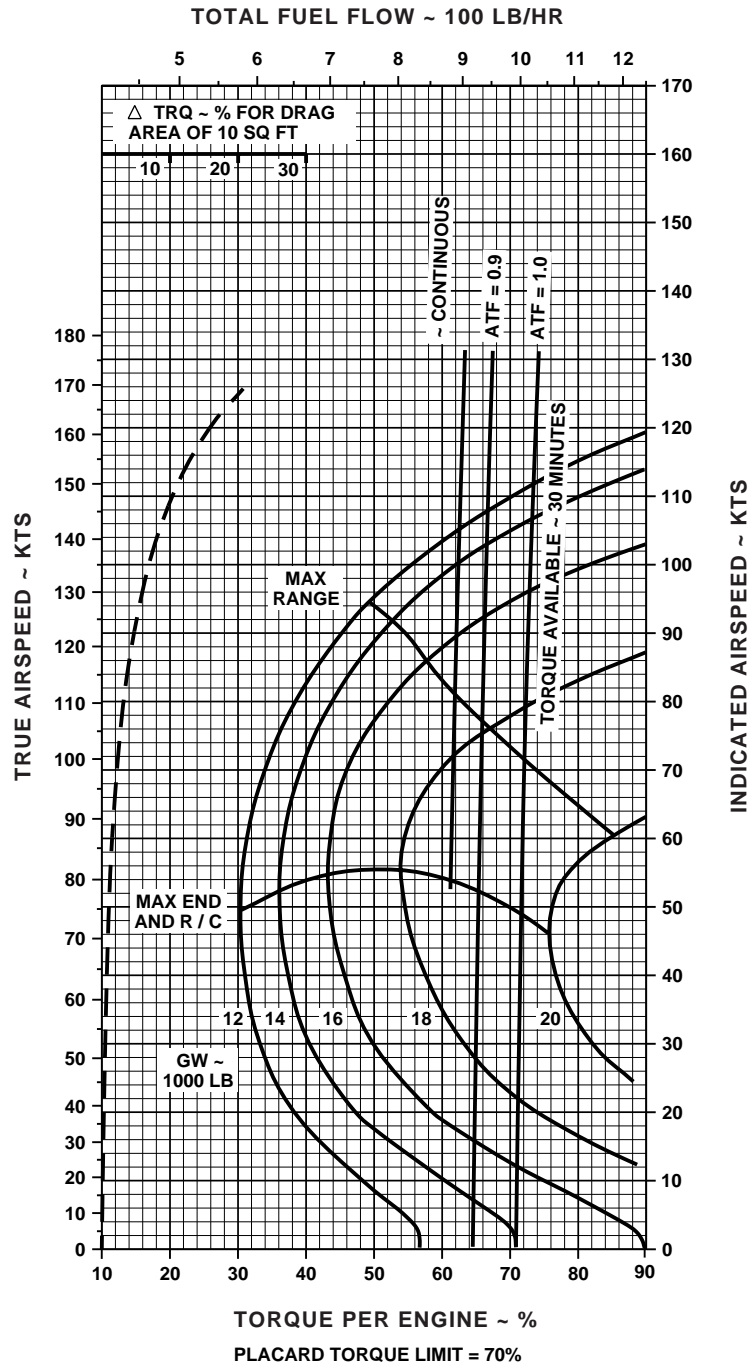
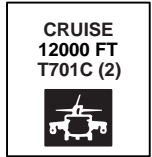

NOTE: SHORT DASH LINES: FERRY MISSION ONLY
DATA BASE: FLIGHT TEST

AA1016_5
SA

Figure 7A-22. Cruise High Drag - Pressure Altitude 12,000 Feet (Sheet 5 of 5)

CRUISE

CLEAN CONFIGURATION

PRESS ALT: 14,000 FT

CRUISE
14,000 FT
T701C (2)

-50°C

-40°C

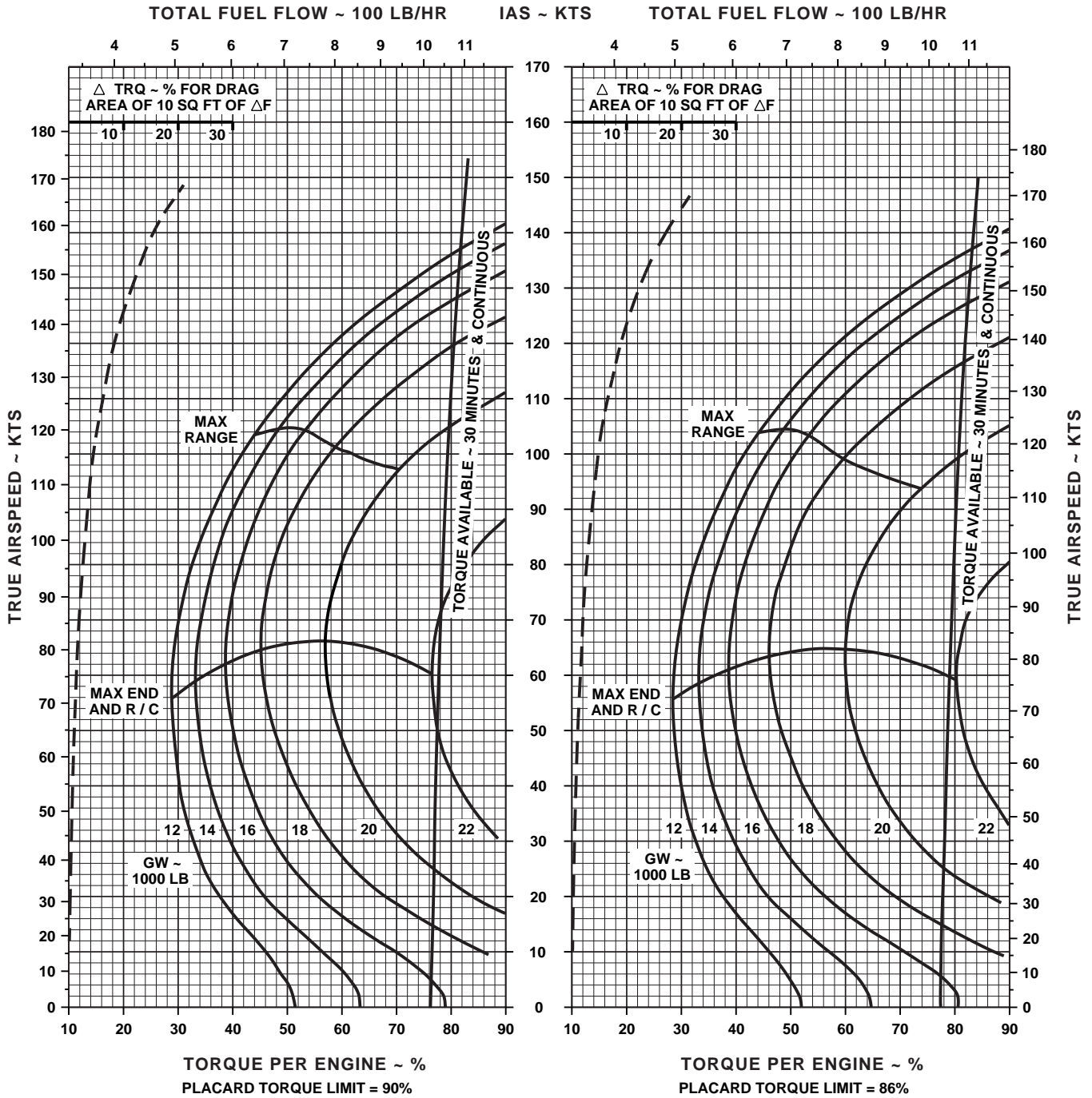

DATA BASE: FLIGHT TEST

AA1017_1
SA

Figure 7A-23. Cruise - Pressure Altitude 14,000 Feet (Sheet 1 of 5)

CRUISE

CLEAN CONFIGURATION

PRESS ALT: 14,000 FT

CRUISE
14,000 FT
T701C (2)

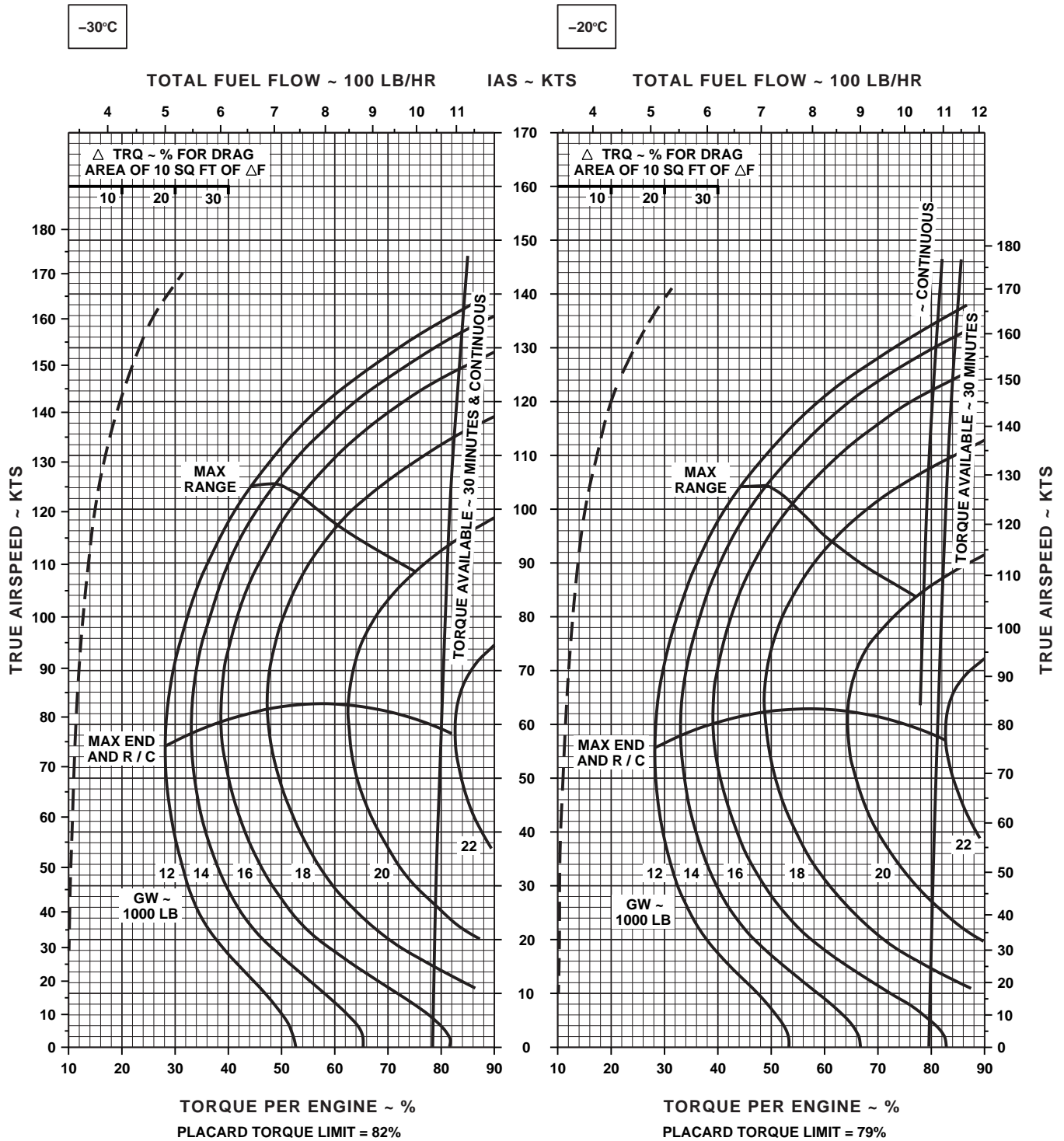

DATA BASE: FLIGHT TEST

AA1017_2
SA

Figure 7A-23. Cruise - Pressure Altitude 14,000 Feet (Sheet 2 of 5)

CRUISE

CLEAN CONFIGURATION

PRESS ALT: 14,000 FT

CRUISE
14,000 FT
T701C (2)

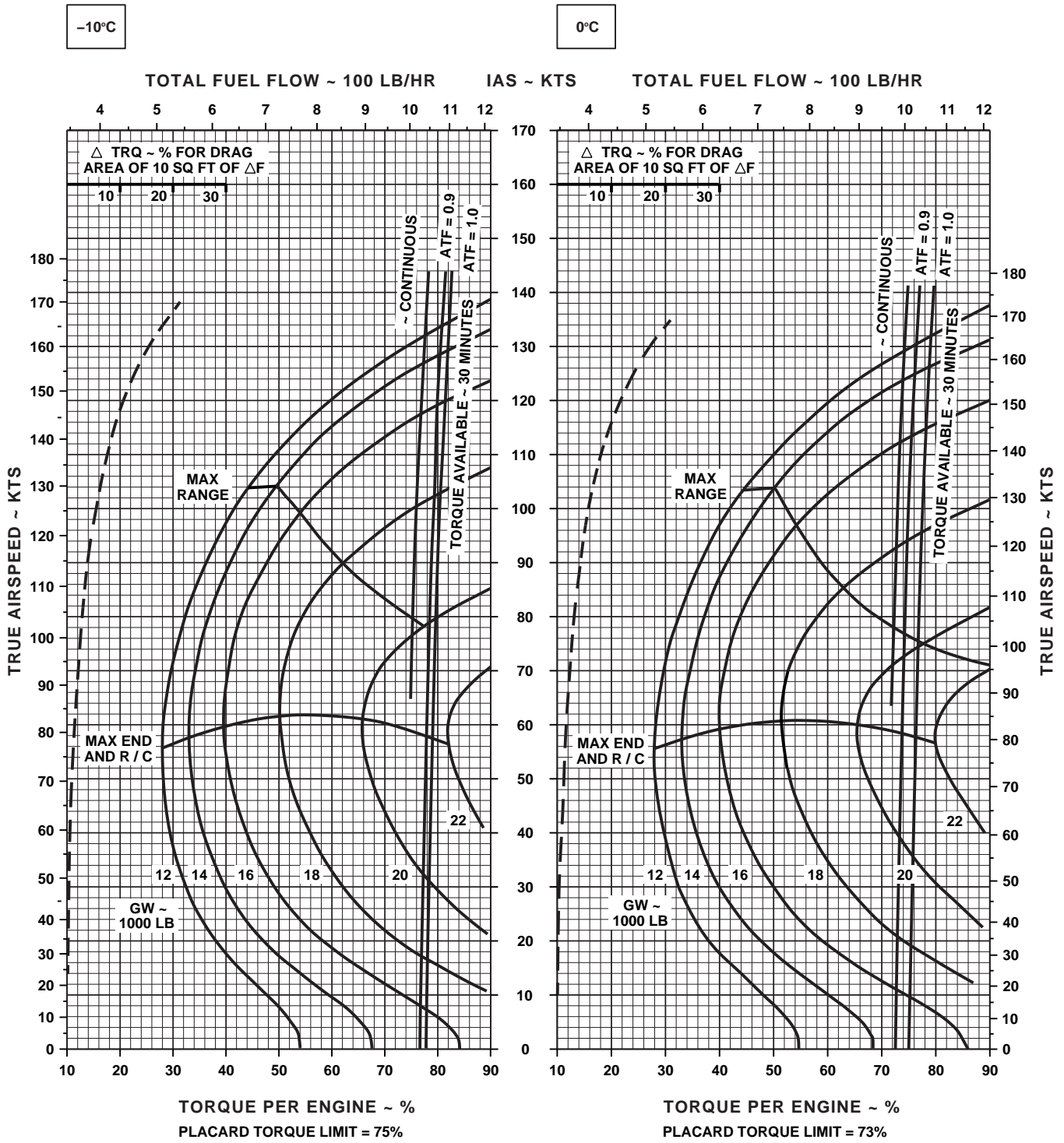

DATA BASE: FLIGHT TEST

AA1017_3
SA

Figure 7A-23. Cruise - Pressure Altitude 14,000 Feet (Sheet 3 of 5)

CRUISE

CLEAN CONFIGURATION

PRESS ALT: 14,000 FT

CRUISE
14,000 FT
T701C (2)

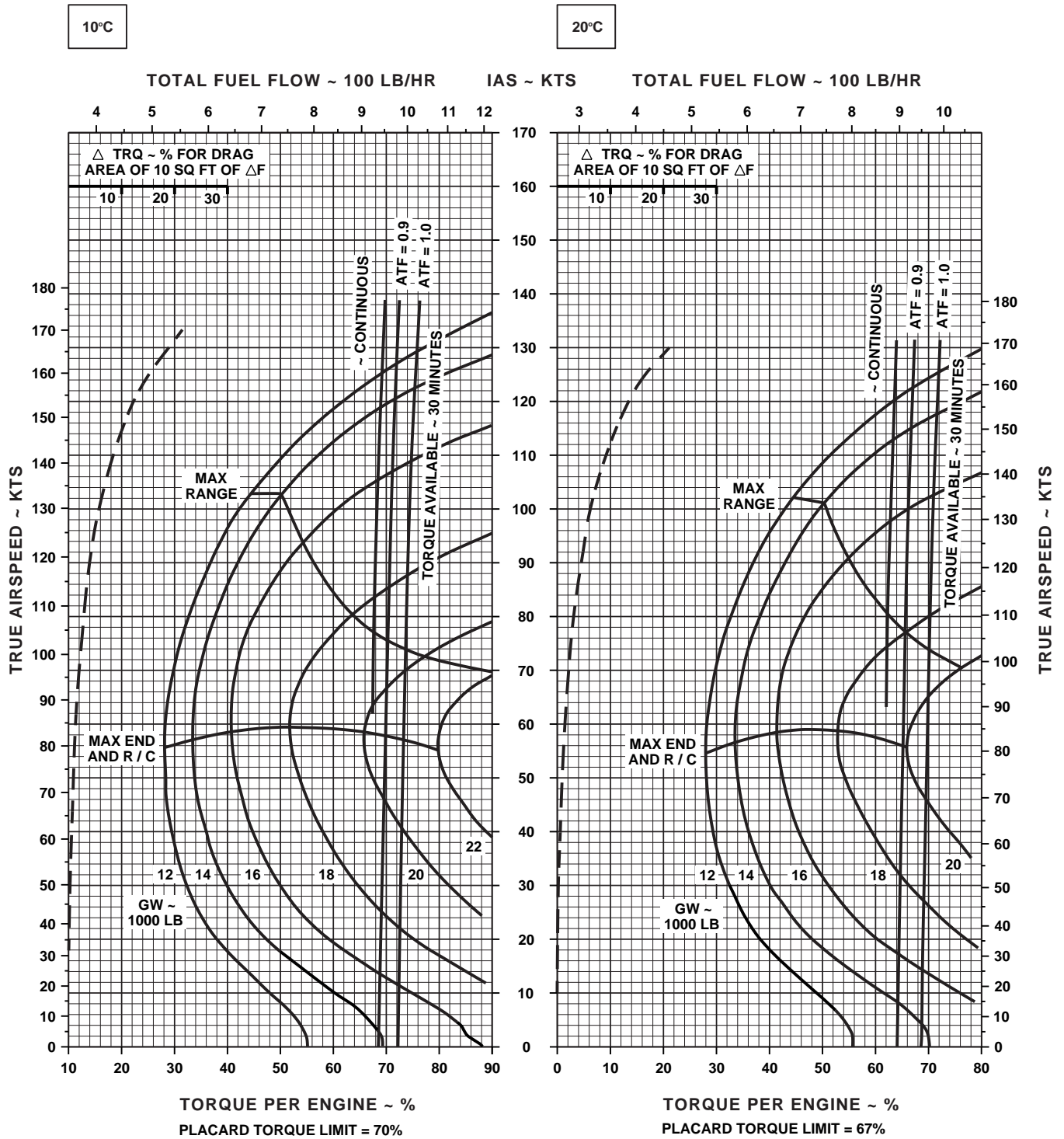

DATA BASIS: FLIGHT TEST

AA1017_4A
SA

Figure 7A-23. Cruise - Pressure Altitude 14,000 Feet (Sheet 4 of 5)

CRUISE

CLEAN CONFIGURATION

PRESS ALT: 14,000 FT

CRUISE
14,000 FT
T701C (2)

30°C

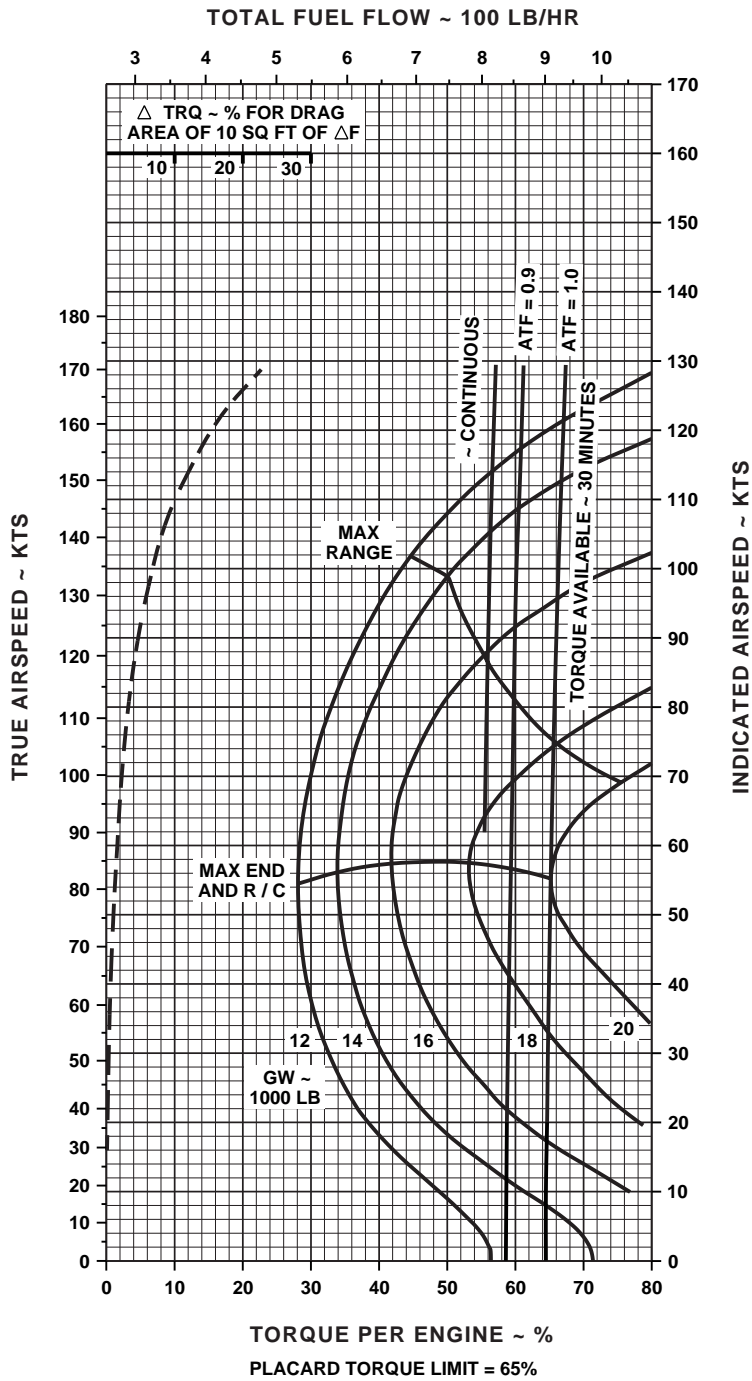

DATA BASE: FLIGHT TEST

AA1017_5
SA

Figure 7A-23. Cruise - Pressure Altitude 14,000 Feet (Sheet 5 of 5)

CRUISE

PRESS ALT: 14000 FT

CRUISE
14000 FT
T701C (2)



-50°C

-40°C

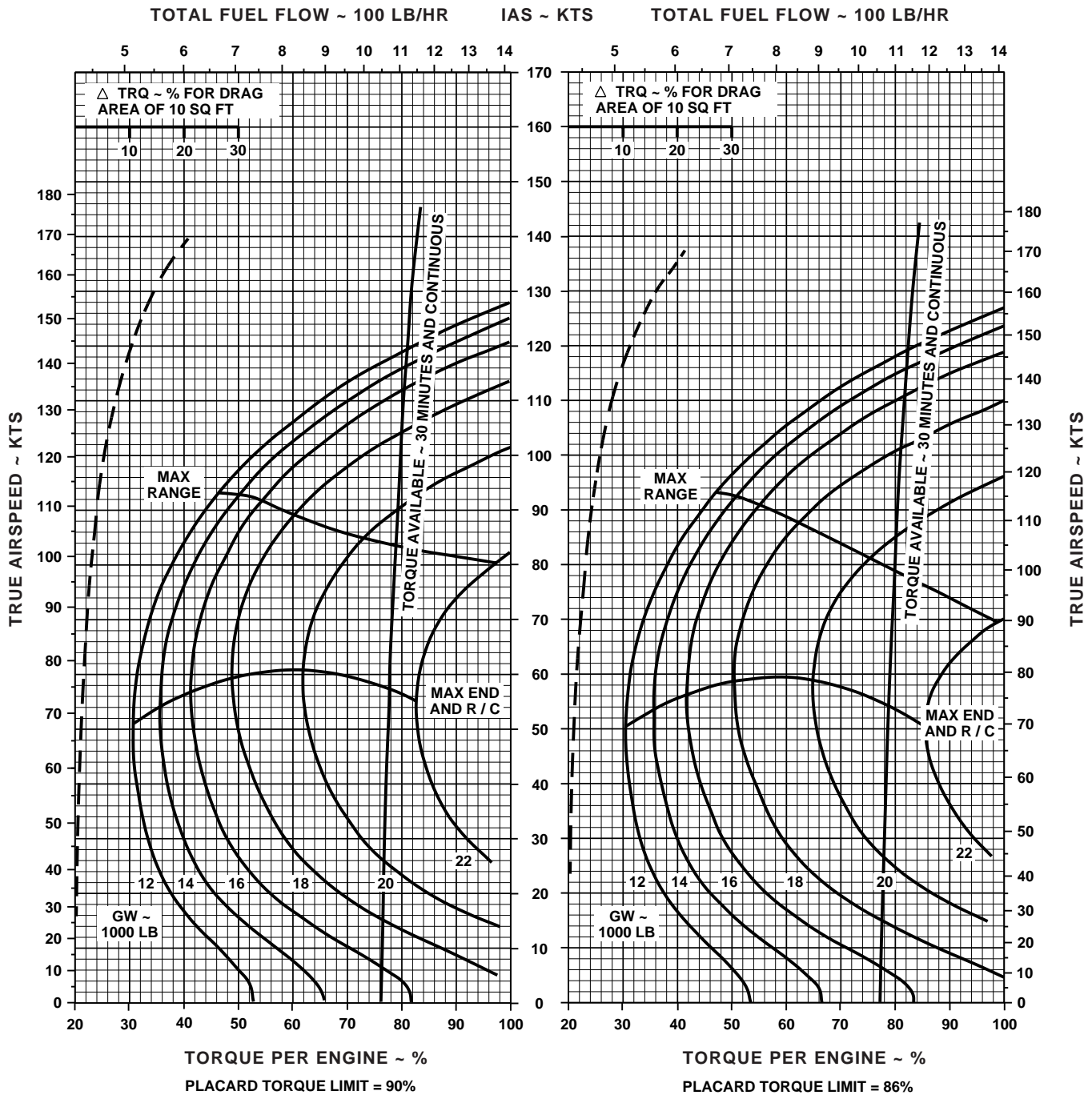

NOTE: SHORT DASH LINES: FERRY MISSION ONLY
DATA BASE: FLIGHT TEST

AA1018_1
SA

Figure 7A-24. Cruise High Drag - Pressure Altitude 14,000 Feet (Sheet 1 of 5)

CRUISE

PRESS ALT: 14000 FT



-30°C

-20°C

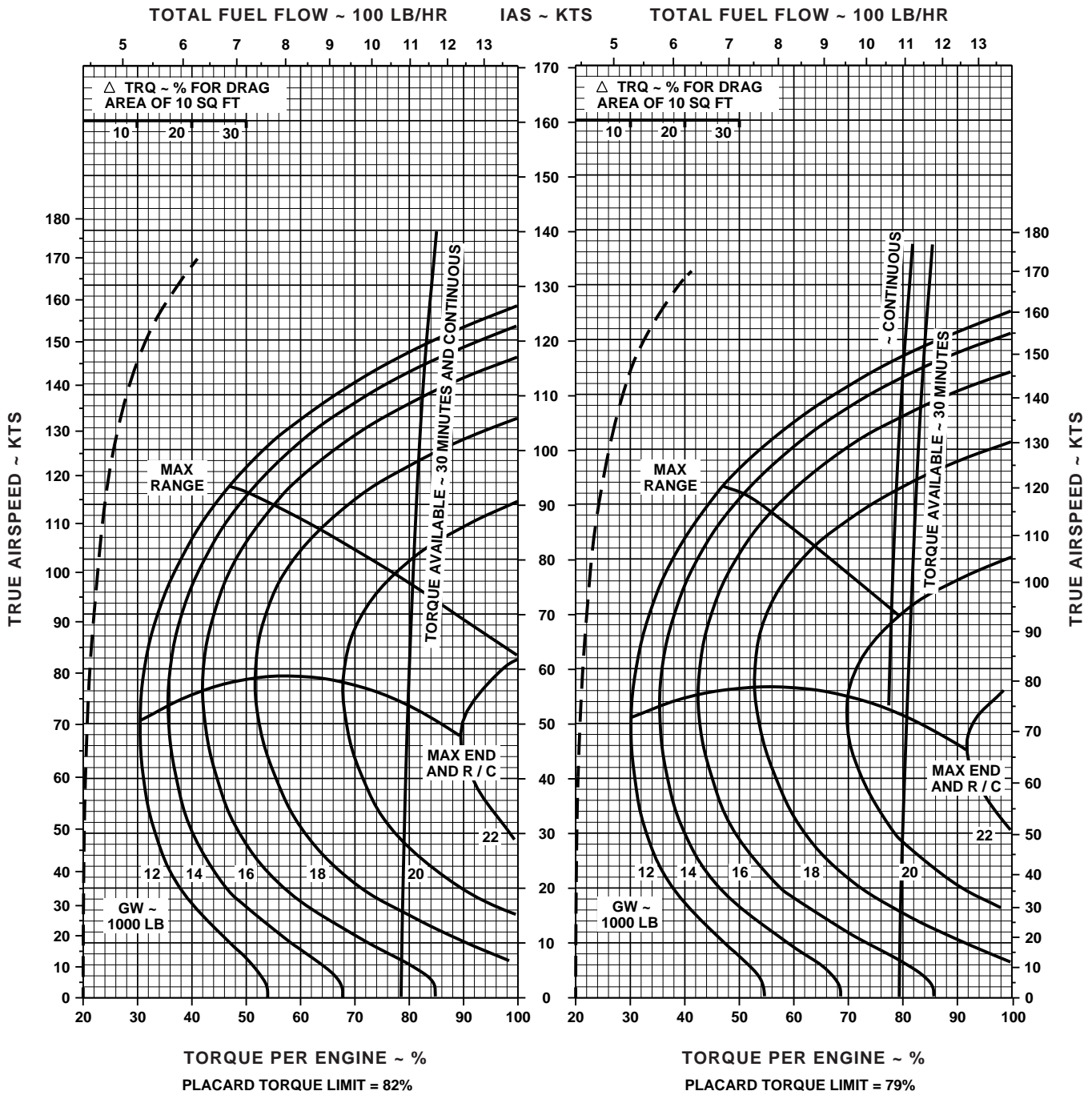

NOTE: SHORT DASH LINES: FERRY MISSION ONLY
 DATA BASE: FLIGHT TEST

AA1018.2
 SA

Figure 7A-24. Cruise High Drag - Pressure Altitude 14,000 Feet (Sheet 2 of 5)

CRUISE

PRESS ALT: 14000 FT

CRUISE
14000 FT
T701C (2)



-10°C

0°C

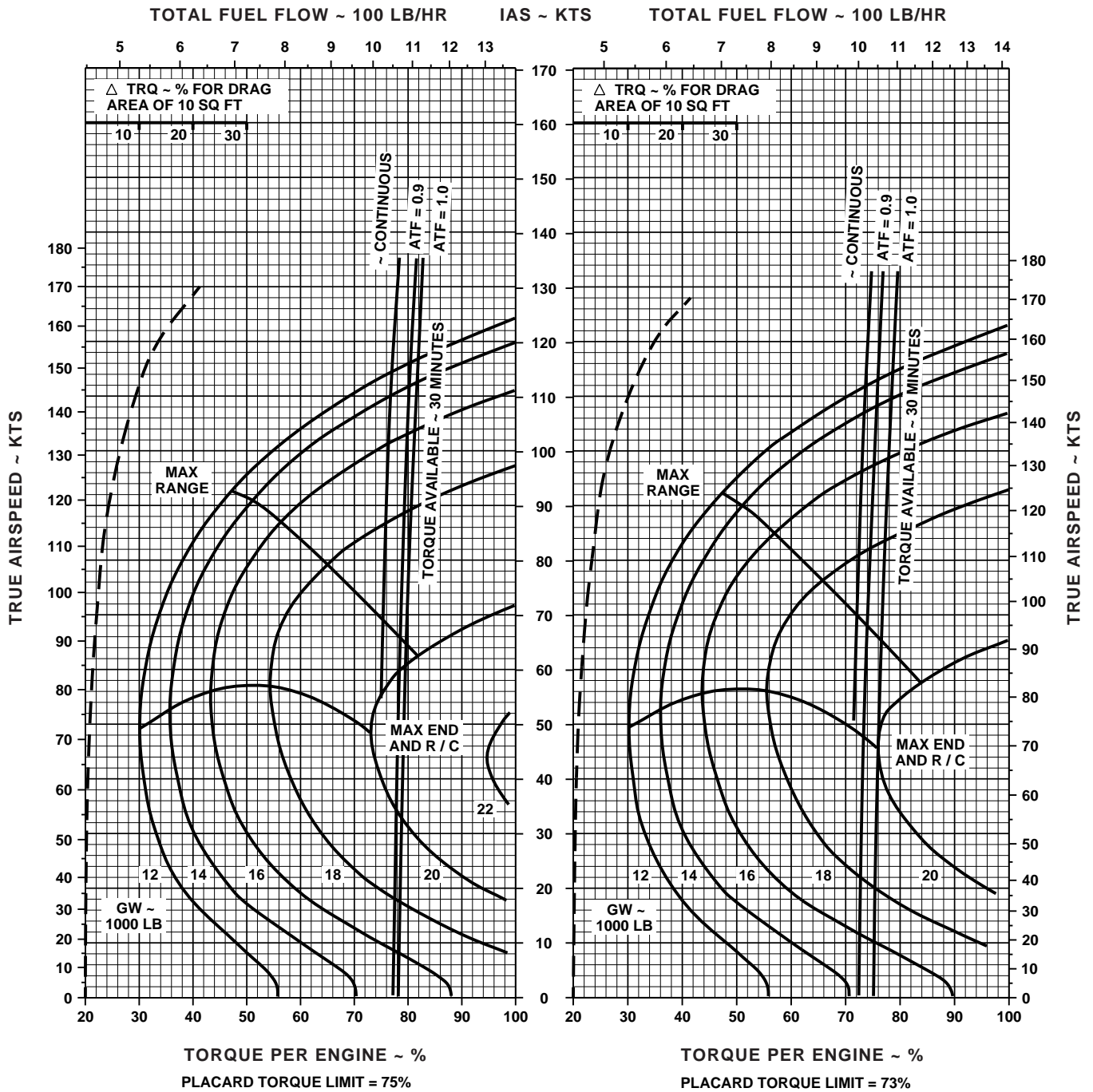

NOTE: SHORT DASH LINES: FERRY MISSION ONLY
DATA BASE: FLIGHT TEST

AA1018_3
SA

Figure 7A-24. Cruise High Drag - Pressure Altitude 14,000 Feet (Sheet 3 of 5)

CRUISE

PRESS ALT: 14000 FT



10°C

20°C

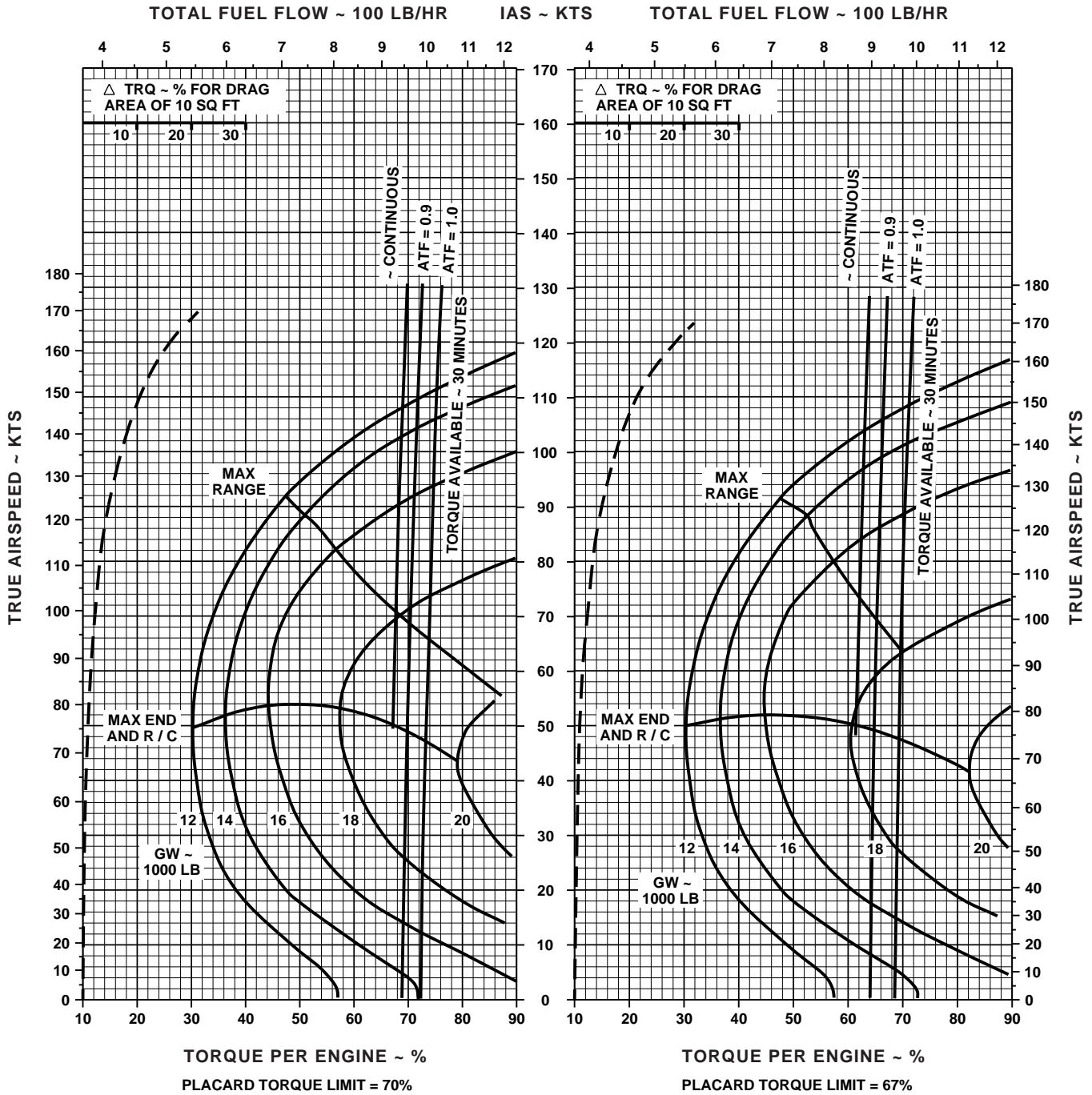

NOTE: SHORT DASH LINES: FERRY MISSION ONLY
 DATA BASE: FLIGHT TEST

AA1018_4
 SA

Figure 7A-24. Cruise High Drag - Pressure Altitude 14,000 Feet (Sheet 4 of 5)

CRUISE

PRESS ALT: 14000 FT

30°C

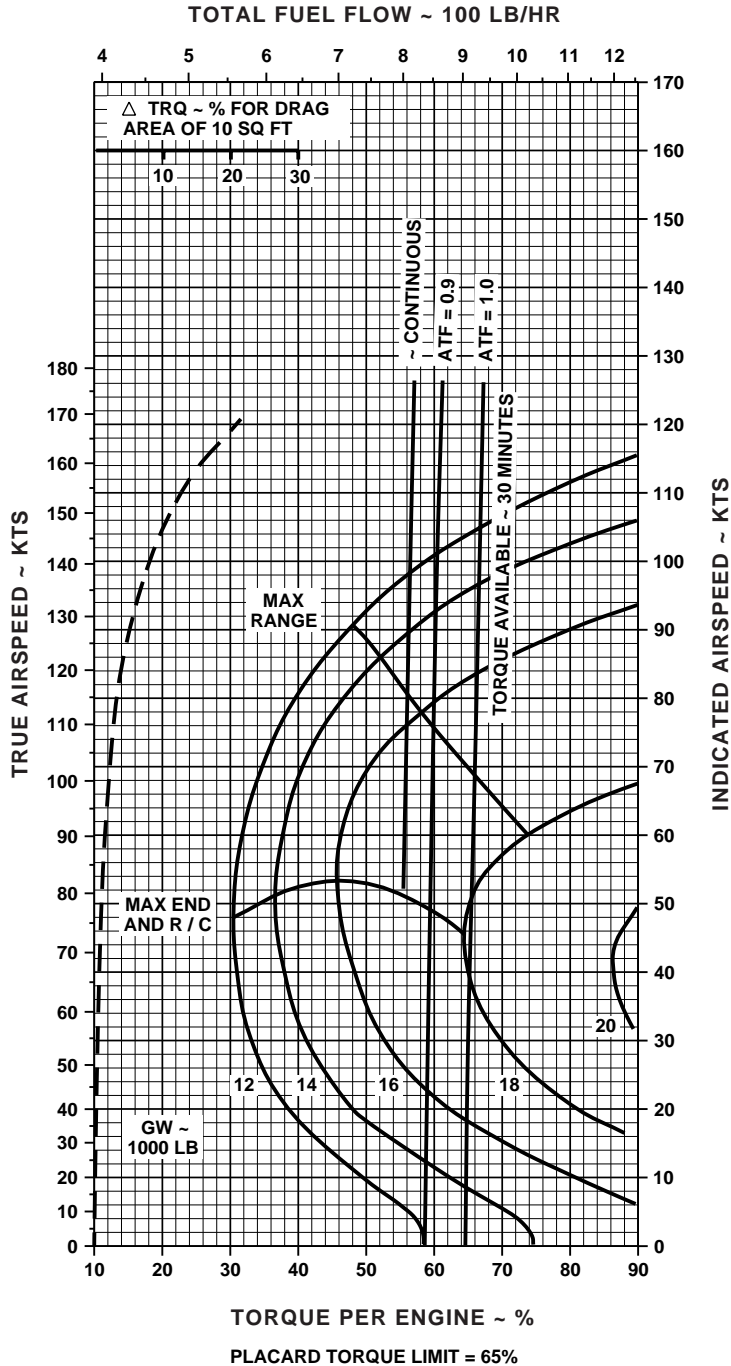
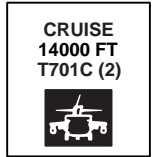

NOTE: SHORT DASH LINES: FERRY MISSION ONLY
DATA BASE: FLIGHT TEST

AA1018.5
SA

Figure 7A-24. Cruise High Drag - Pressure Altitude 14,000 Feet (Sheet 5 of 5)

CRUISE

CLEAN CONFIGURATION

PRESS ALT: 16,000 FT

CRUISE
16,000 FT
T701C (2)

-50°C

-40°C

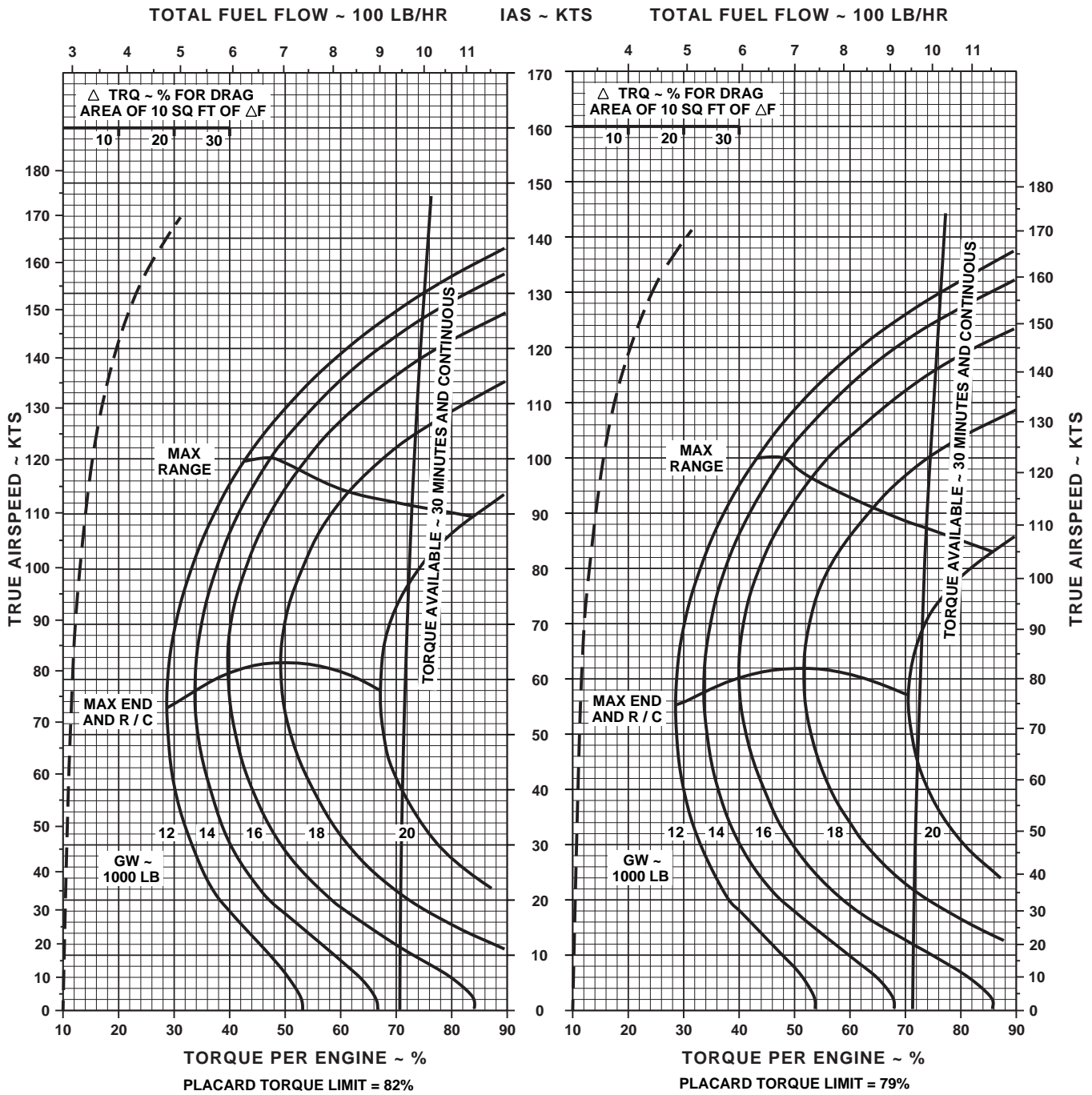

DATA BASE: FLIGHT TEST

AA1019_1
SA

Figure 7A-25. Cruise - Pressure Altitude 16,000 Feet (Sheet 1 of 4)

CRUISE

CLEAN CONFIGURATION

PRESS ALT: 16,000 FT

CRUISE
16,000 FT
T701C (2)

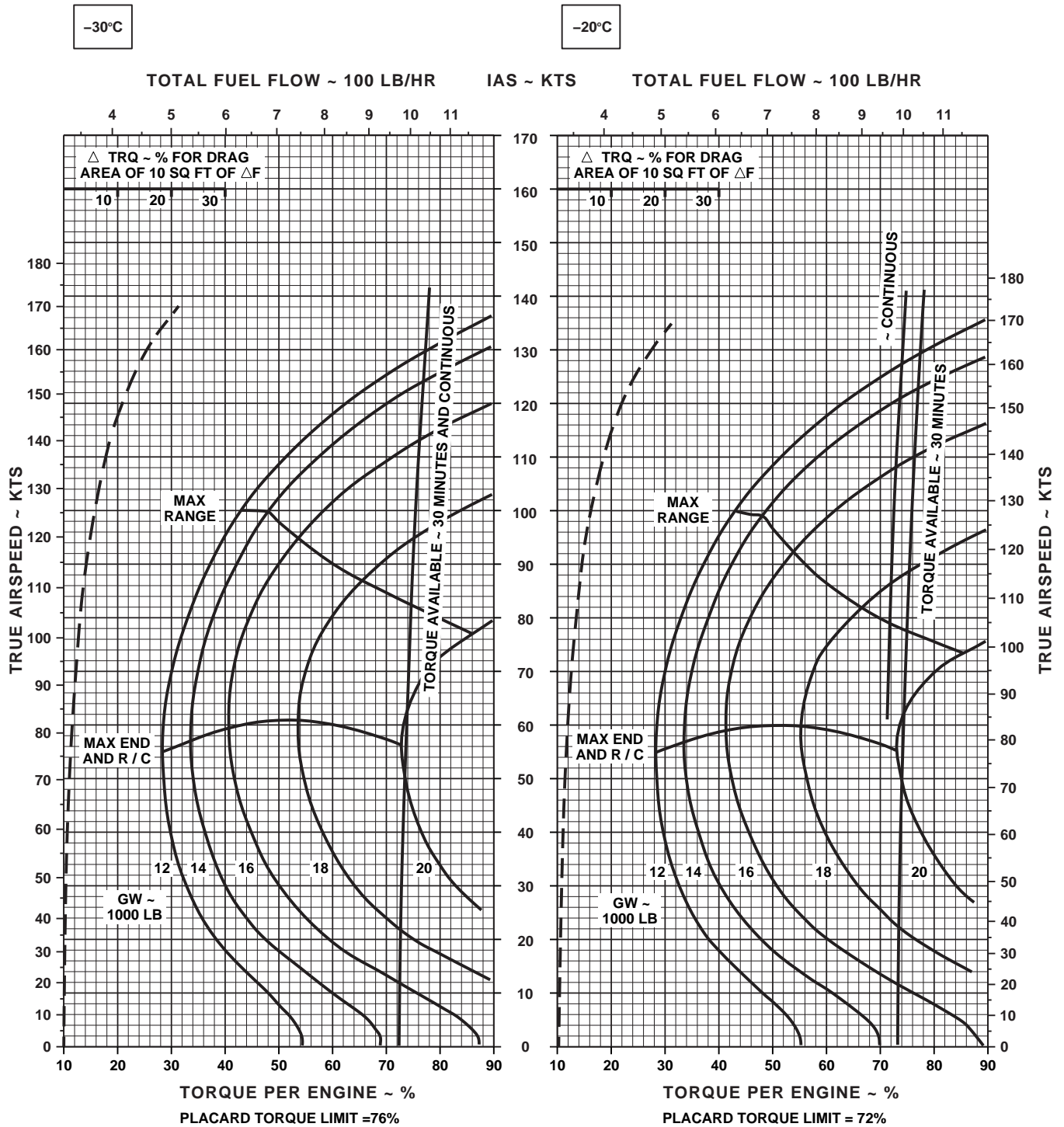

DATA BASE: FLIGHT TEST

AA1019_2
SA

Figure 7A-25. Cruise - Pressure Altitude 16,000 Feet (Sheet 2 of 4)

CRUISE

CLEAN CONFIGURATION

PRESS ALT: 16,000 FT

CRUISE
16,000 FT
T701C (2)

-10°C

0°C

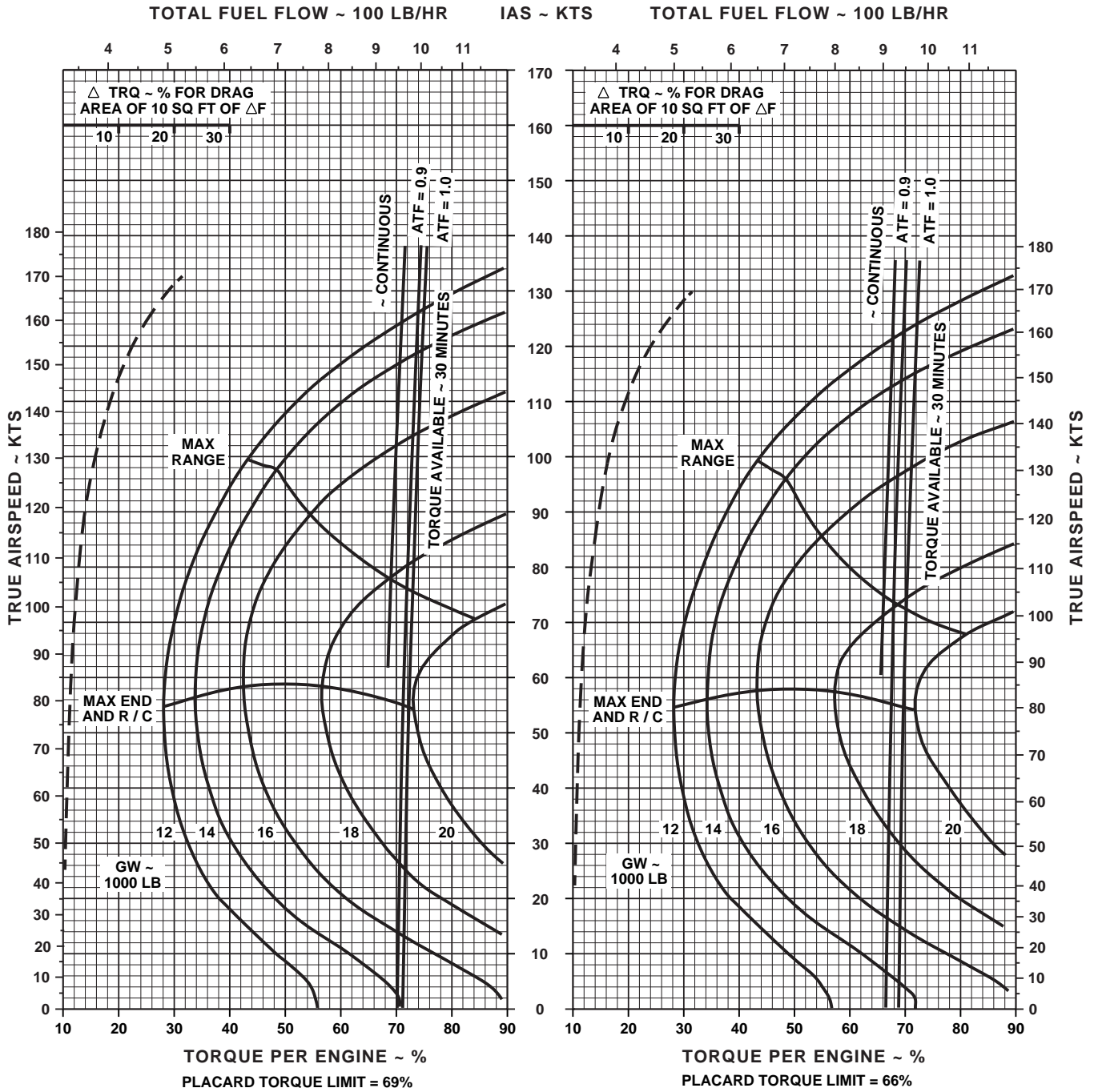

DATA BASE: FLIGHT TEST

AA1019_3
SA

Figure 7A-25. Cruise - Pressure Altitude 16,000 Feet (Sheet 3 of 4)

CRUISE

CLEAN CONFIGURATION

PRESS ALT: 16,000 FT

CRUISE
16,000 FT
T701C (2)

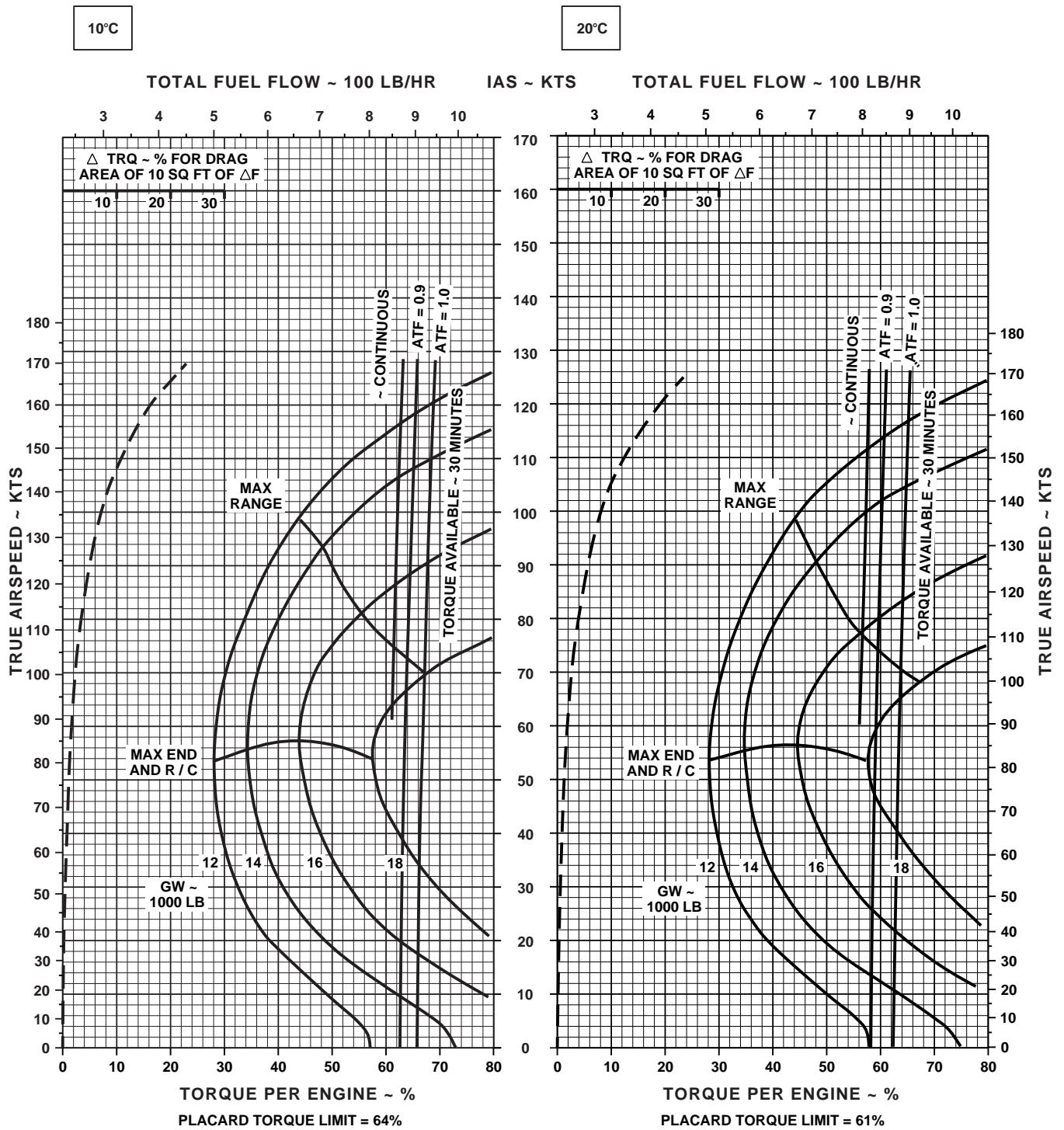

DATA BASE: FLIGHT TEST

AA1019_4
SA

Figure 7A-25. Cruise - Pressure Altitude 16,000 Feet (Sheet 4 of 4)

CRUISE

PRESS ALT: 16000 FT

CRUISE
16000 FT
T701C (2)



-50°C

-40°C

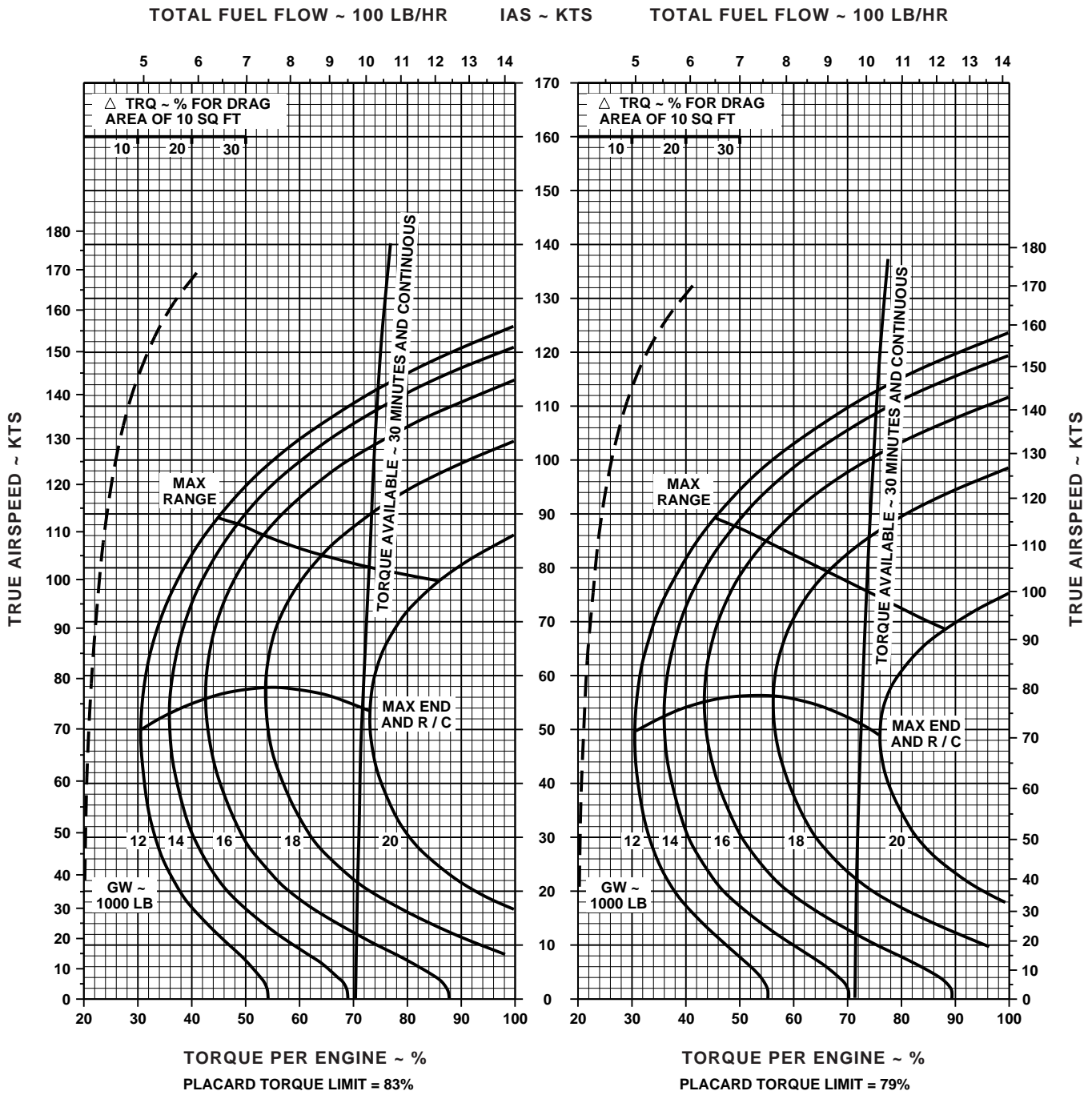

NOTE: SHORT DASH LINES: FERRY MISSION ONLY
DATA BASE: FLIGHT TEST

AA1020_1
SA

Figure 7A-26. Cruise High Drag - Pressure Altitude 16,000 Feet (Sheet 1 of 4)

CRUISE

PRESS ALT: 16000 FT

CRUISE
16000 FT
T701C (2)



-30°C

-20°C

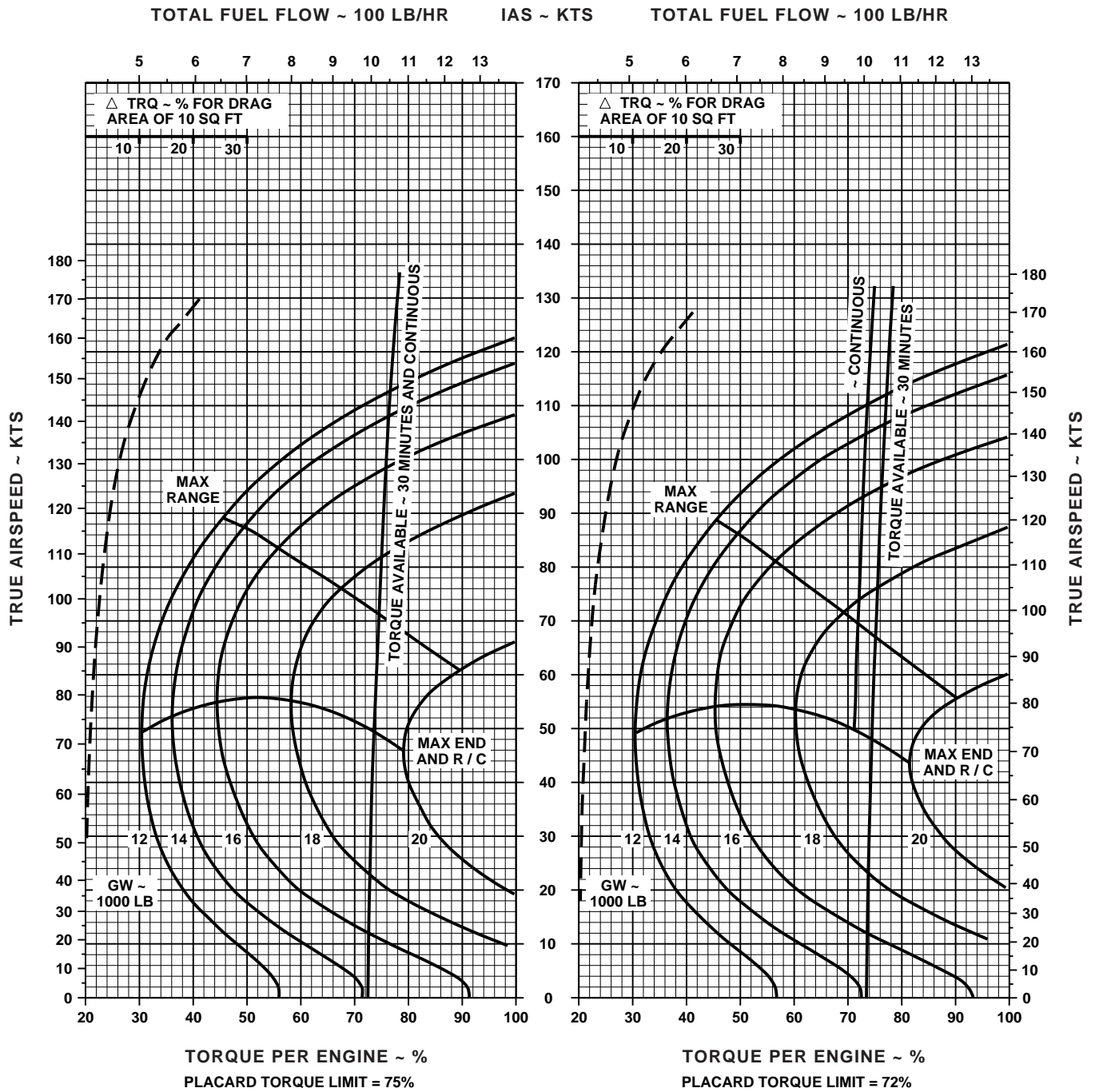

NOTE: SHORT DASH LINES: FERRY MISSION ONLY
DATA BASE: FLIGHT TEST

AA1020_2
SA

Figure 7A-26. Cruise High Drag - Pressure Altitude 16,000 Feet (Sheet 2 of 4)

CRUISE

PRESS ALT: 16000 FT

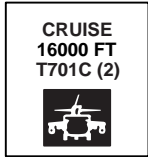

-10°C

0°C

TOTAL FUEL FLOW ~ 100 LB/HR

IAS ~ KTS

TOTAL FUEL FLOW ~ 100 LB/HR

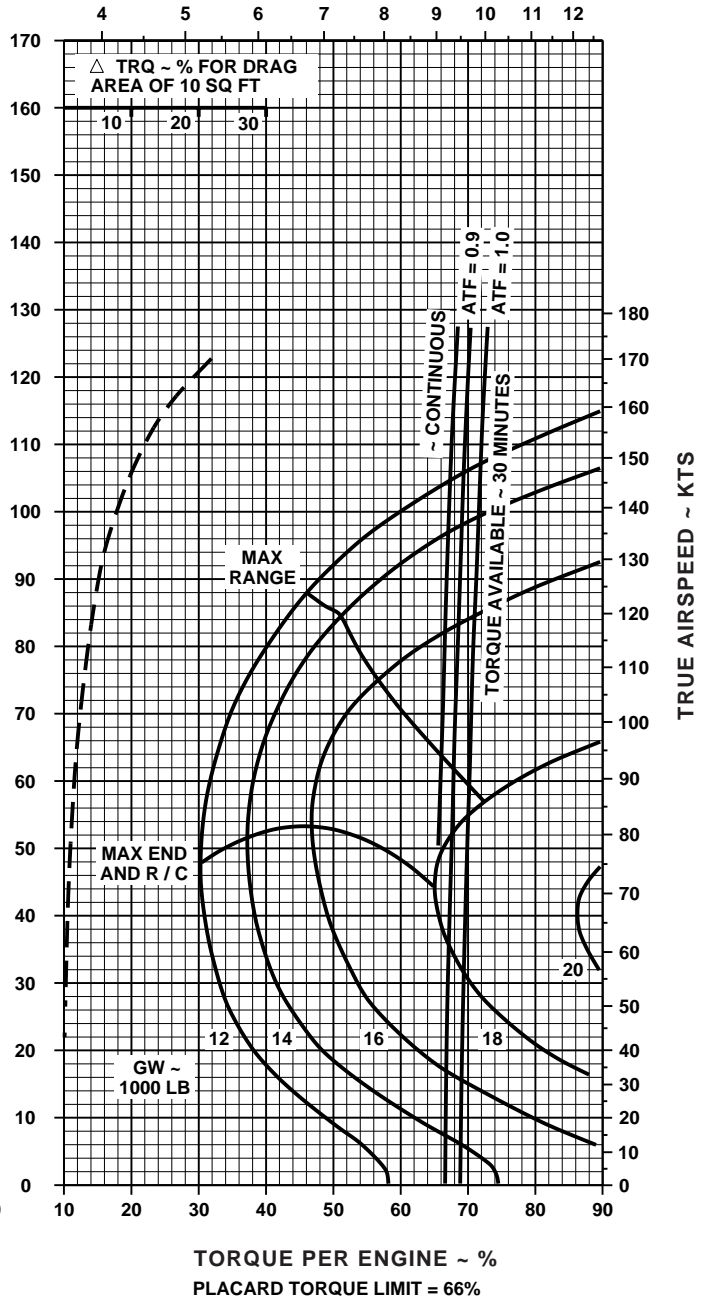
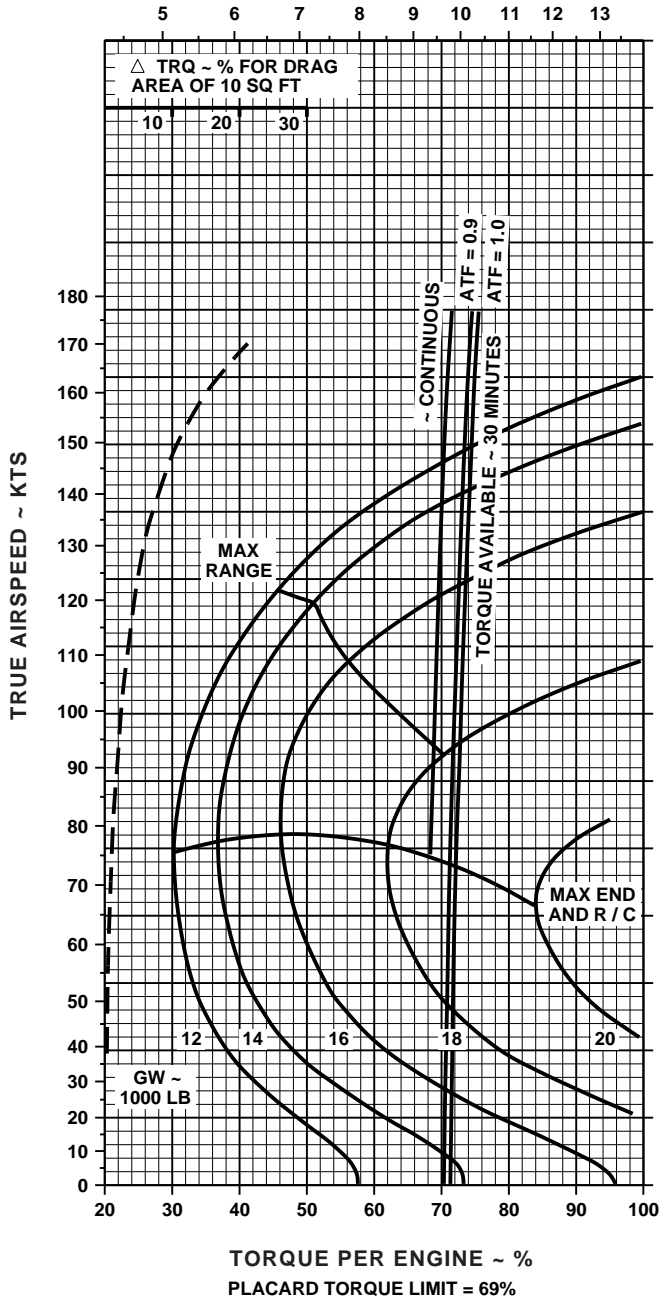

NOTE: SHORT DASH LINES: FERRY MISSION ONLY
DATA BASE: FLIGHT TEST

AA1020_3
SA

Figure 7A-26. Cruise High Drag - Pressure Altitude 16,000 Feet (Sheet 3 of 4)

CRUISE

PRESS ALT: 16000 FT

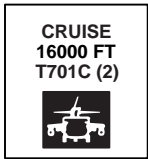

10°C

20°C

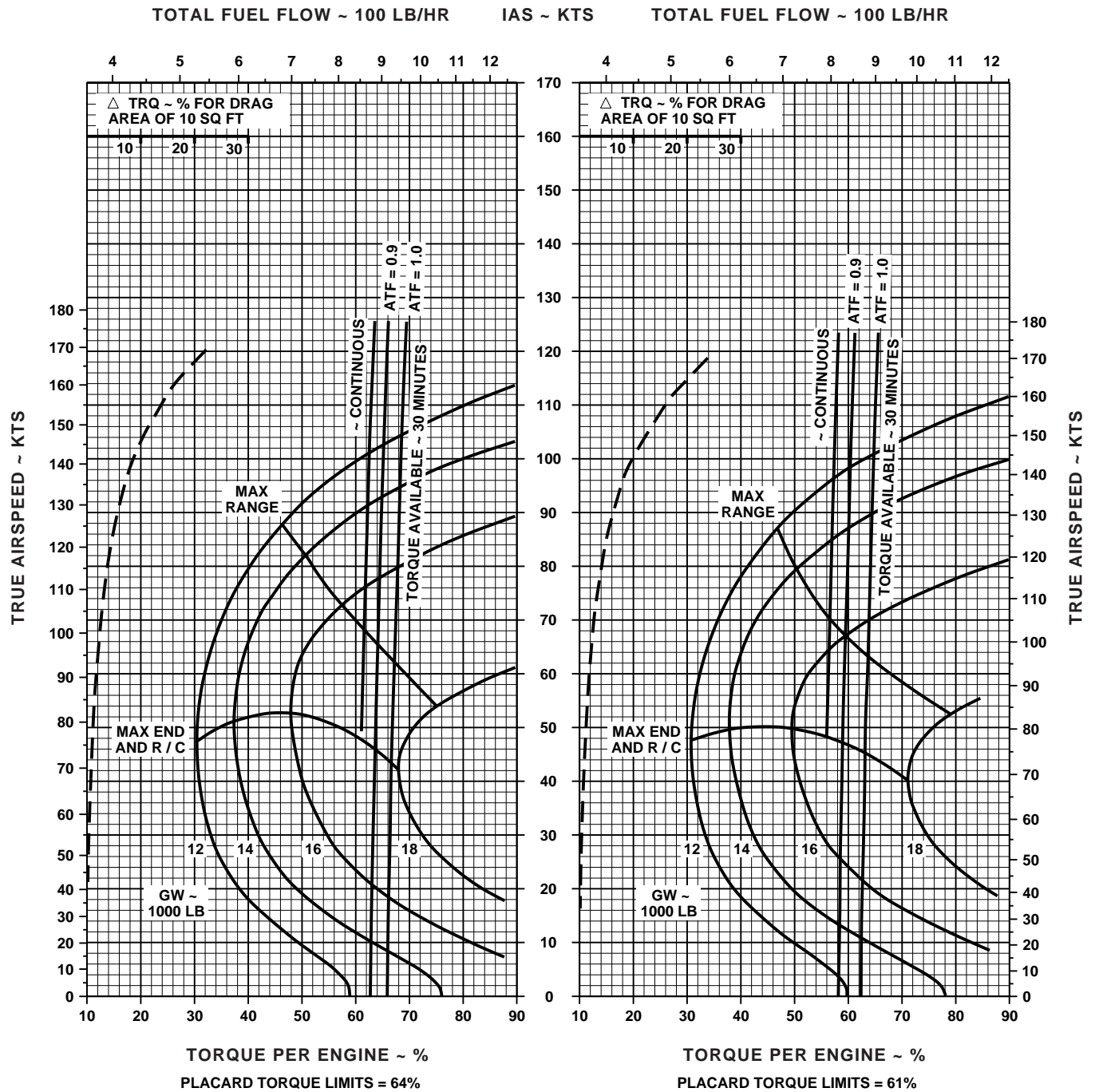

NOTE: SHORT DASH LINES: FERRY MISSION ONLY
DATA BASE: FLIGHT TEST

AA1020_4
SA

Figure 7A-26. Cruise High Drag - Pressure Altitude 16,000 Feet (Sheet 4 of 4)

CRUISE

CLEAN CONFIGURATION

PRESS ALT: 18,000 FT

CRUISE
18,000 FT
T701C (2)

-50°C

-40°C

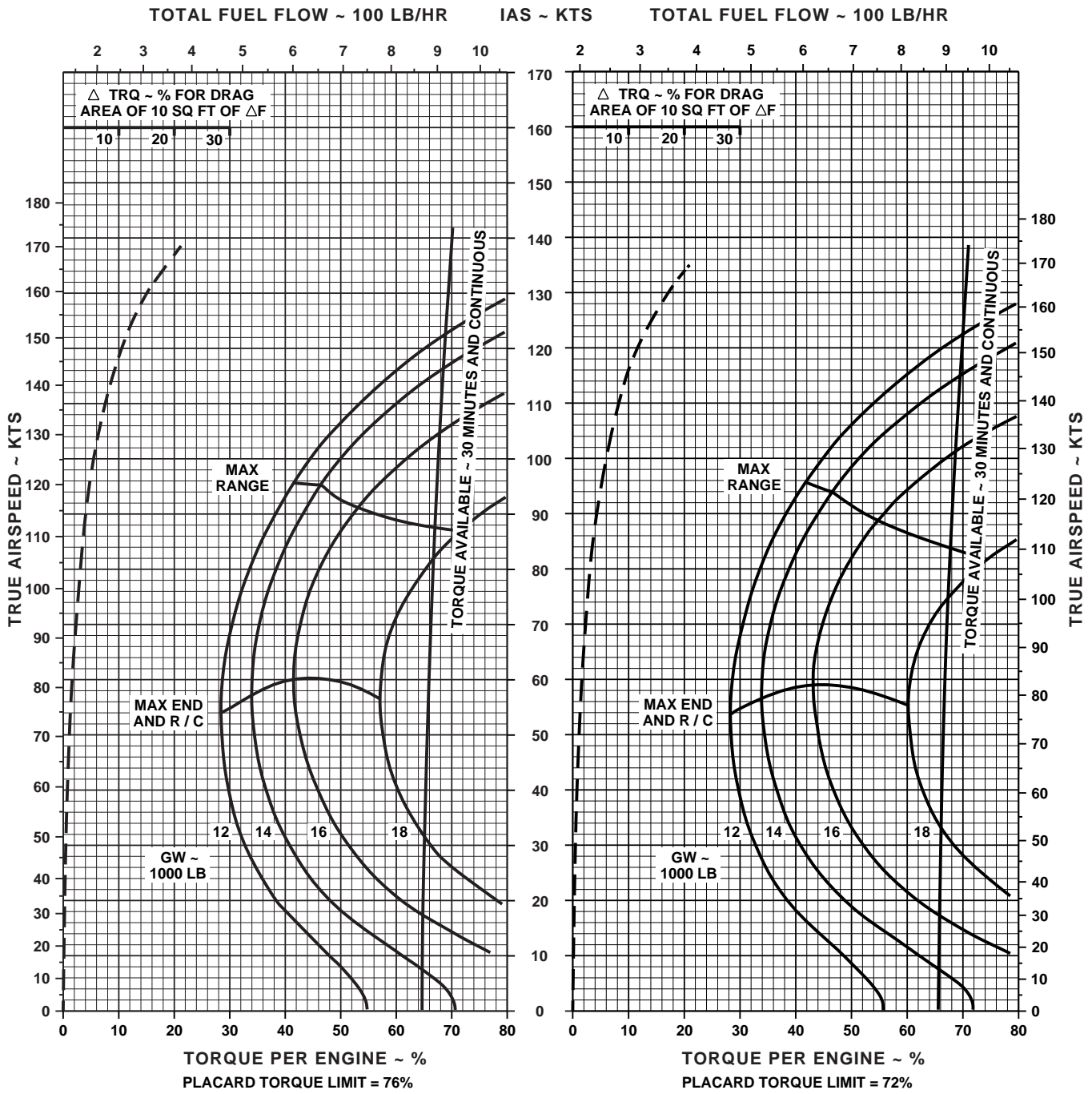

DATA BASE: FLIGHT TEST

AA1021_1
SA

Figure 7A-27. Cruise - Pressure Altitude 18,000 Feet (Sheet 1 of 4)

CRUISE

CLEAN CONFIGURATION

PRESS ALT: 18,000 FT

CRUISE
18,000 FT
T701C (2)

-30°C

-20°C

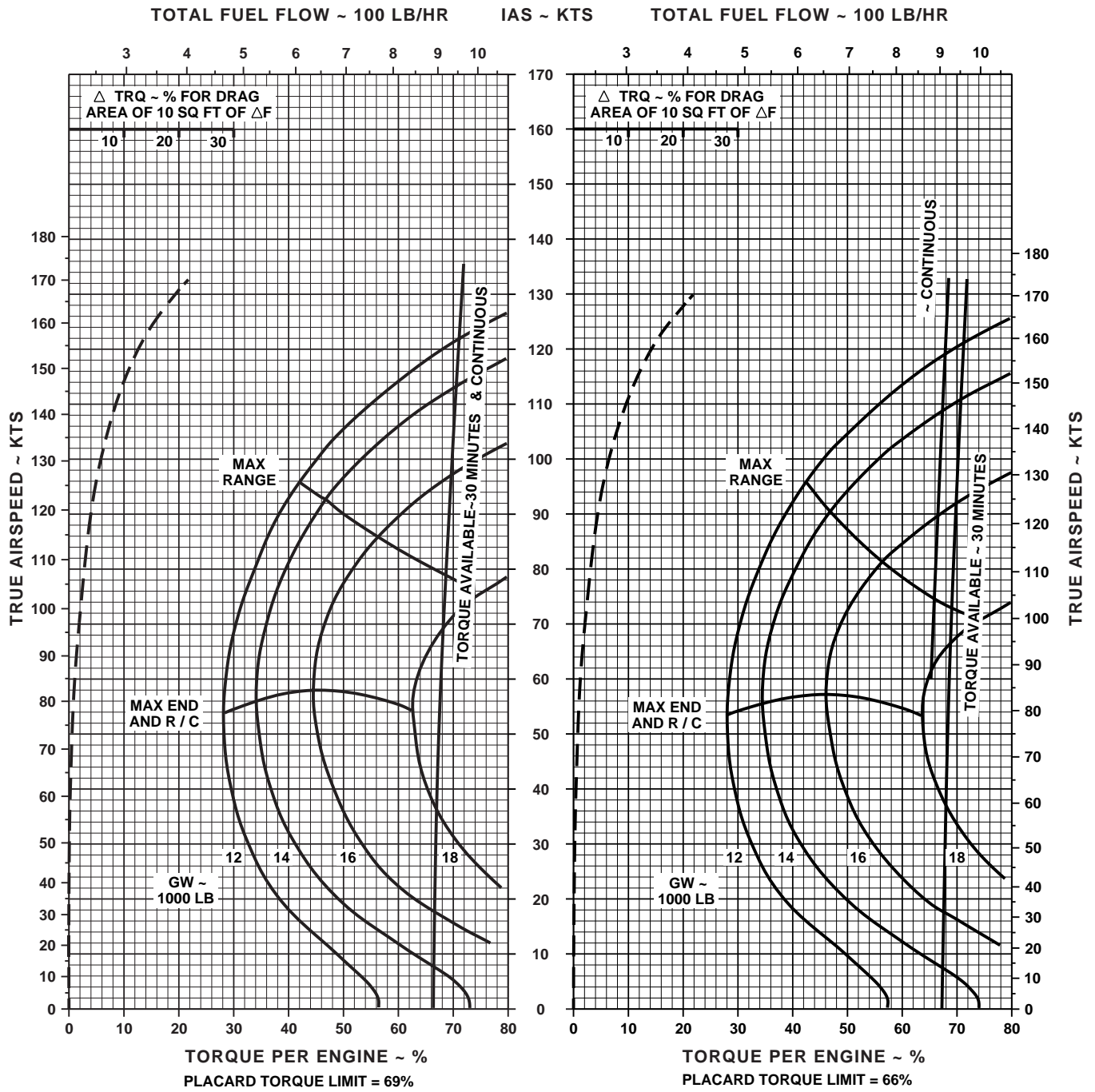

DATA BASE: FLIGHT TEST

AA1021_2
SA

Figure 7A-27. Cruise - Pressure Altitude 18,000 Feet (Sheet 2 of 4)

CRUISE

CLEAN CONFIGURATION

PRESS ALT: 18,000 FT

CRUISE
18,000 FT
T701C (2)

-10°C

0°C

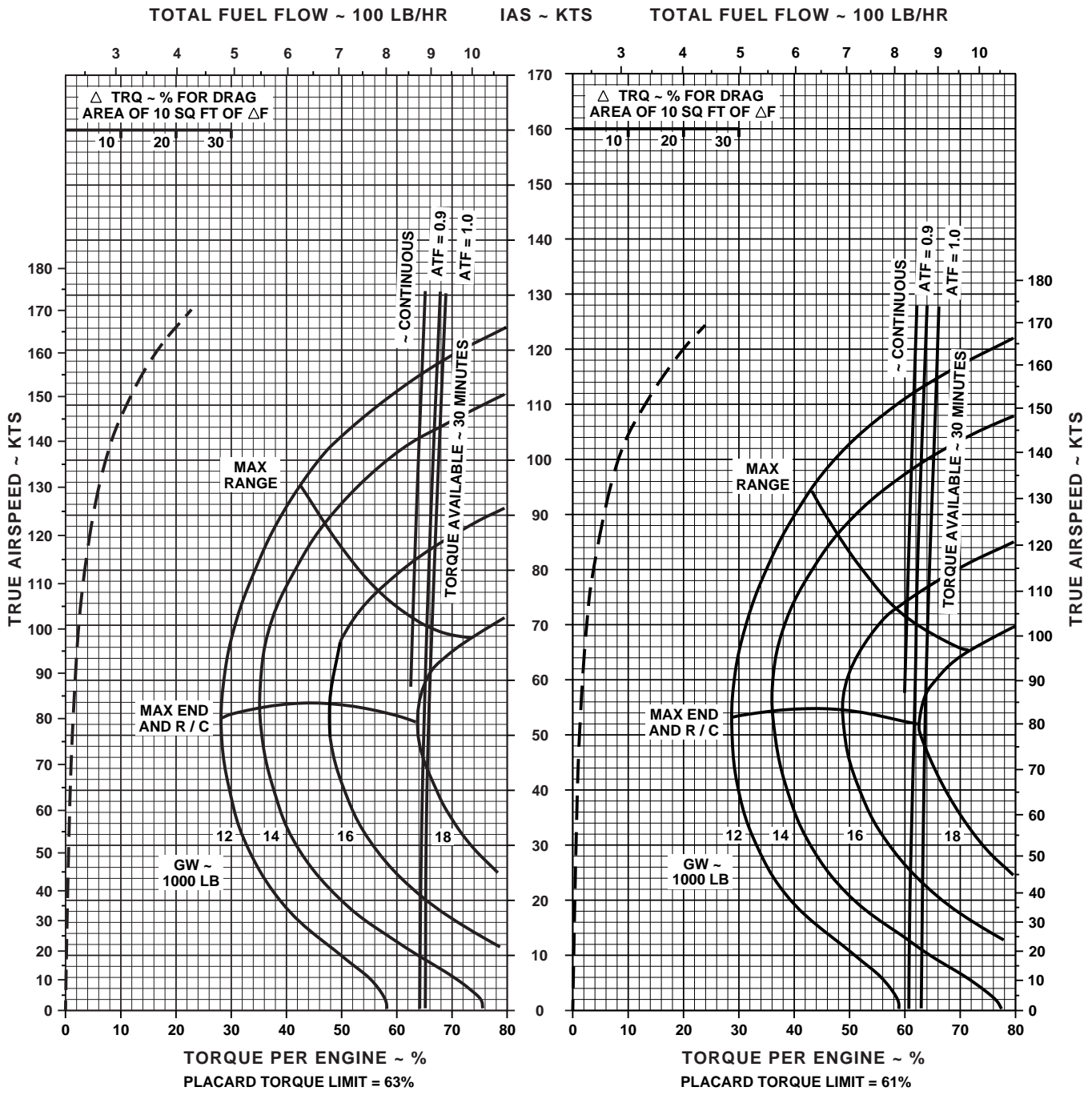

DATA BASE: FLIGHT TEST

AA1021_3
SA

Figure 7A-27. Cruise - Pressure Altitude 18,000 Feet (Sheet 3 of 4)

CRUISE

CLEAN CONFIGURATION

PRESS ALT: 18,000 FT

CRUISE
18,000 FT
T701C (2)

10°C

20°C

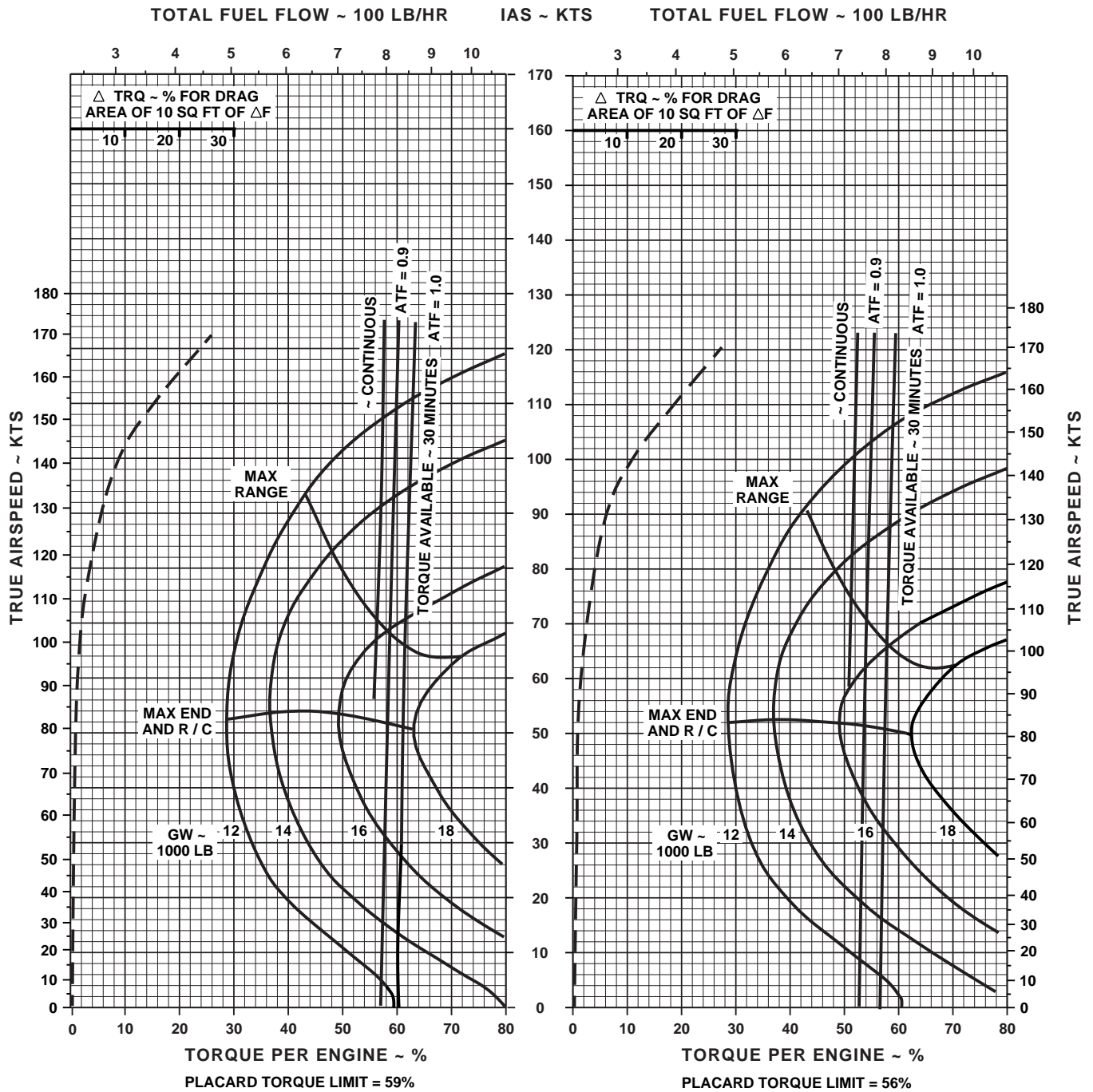

DATA BASE: FLIGHT TEST

AA1021_4
SA

Figure 7A-27. Cruise - Pressure Altitude 18,000 Feet (Sheet 4 of 4)

CRUISE

PRESS ALT: 18000 FT



-50°C

-40°C

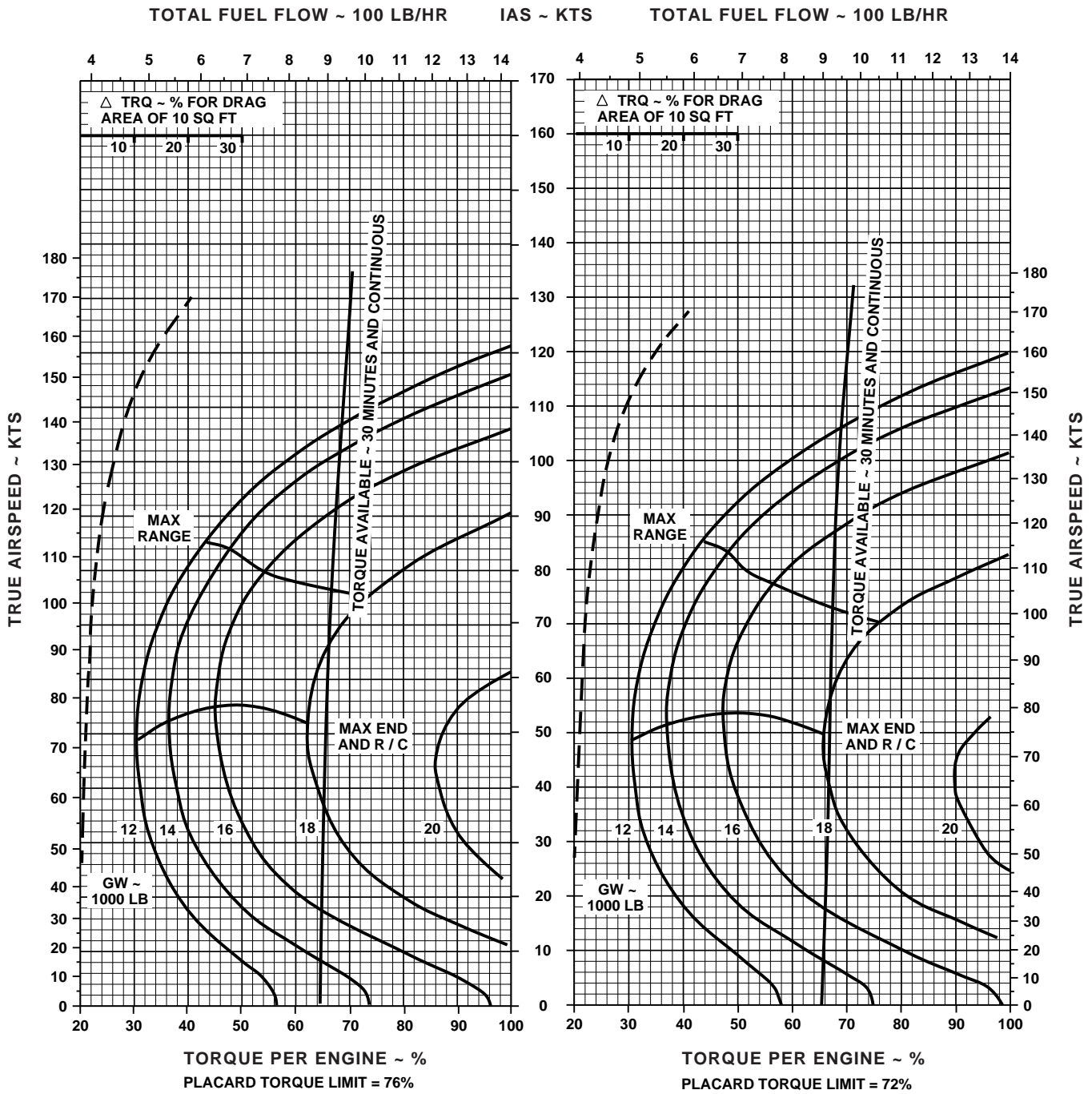

NOTE: SHORT DASH LINES: FERRY MISSION ONLY
 DATA BASE: FLIGHT TEST

AA1022_1
 SA

Figure 7A-28. Cruise High Drag - Pressure Altitude 18,000 Feet (Sheet 1 of 4)

CRUISE

PRESS ALT: 18000 FT

CRUISE
18000 FT
T701C (2)



-30°C

-20°C

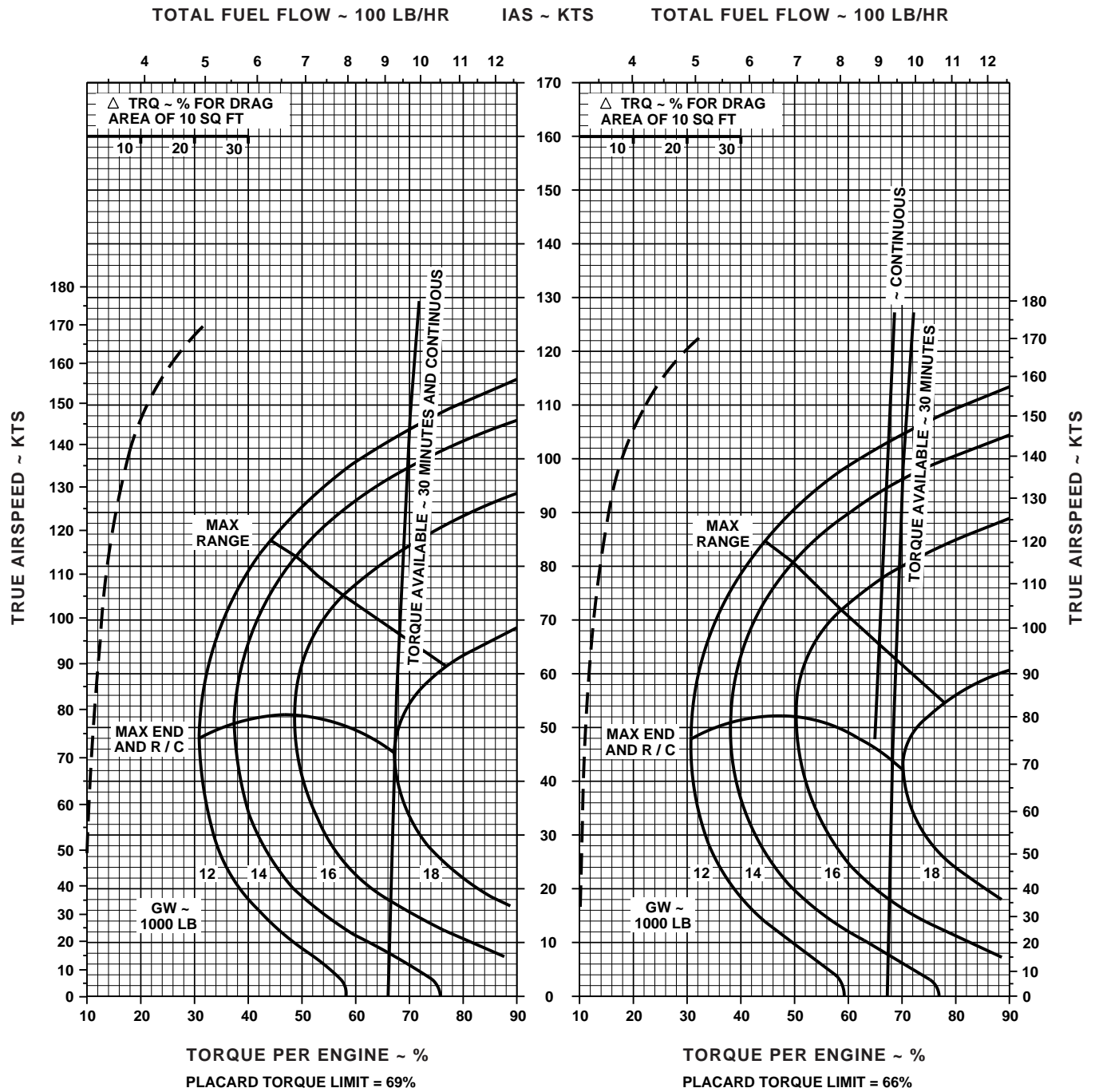

NOTE: SHORT DASH LINES: FERRY MISSION ONLY
DATA BASE: FLIGHT TEST

AA1022_2
SA

Figure 7A-28. Cruise High Drag - Pressure Altitude 18,000 Feet (Sheet 2 of 4)

CRUISE

PRESS ALT: 18000 FT

CRUISE
18000 FT
T701C (2)



-10°C

0°C

TOTAL FUEL FLOW ~ 100 LB/HR

IAS ~ KTS

TOTAL FUEL FLOW ~ 100 LB/HR

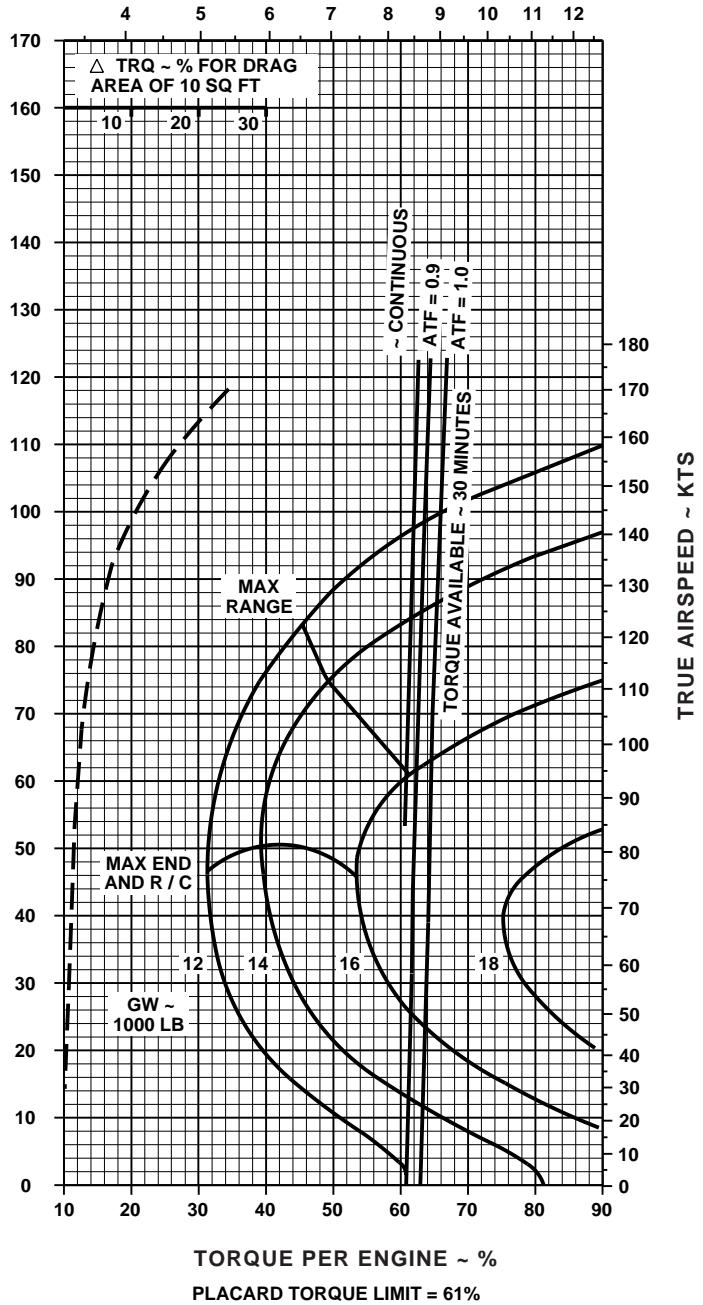
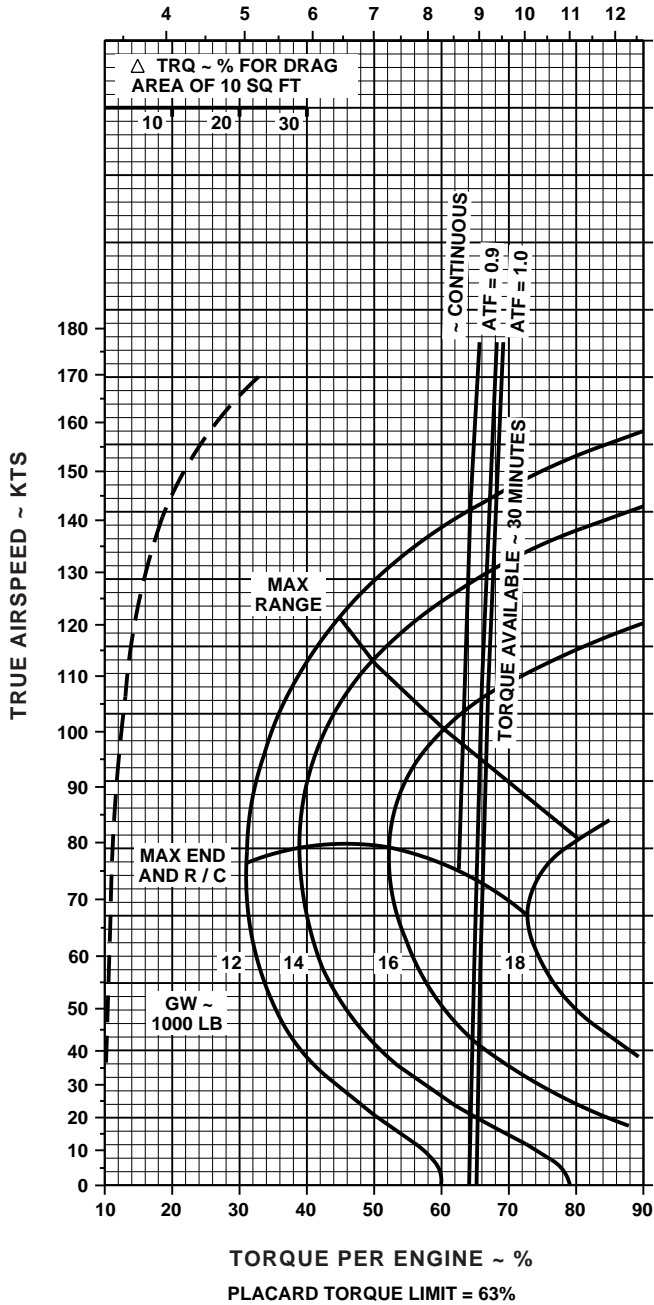

NOTE: SHORT DASH LINES: FERRY MISSION ONLY
DATA BASE: FLIGHT TEST

A1022_3
SA

Figure 7A-28. Cruise High Drag - Pressure Altitude 18,000 Feet (Sheet 3 of 4)

CRUISE

PRESS ALT: 18000 FT

CRUISE
18000 FT
T701C (2)



10°C

20°C

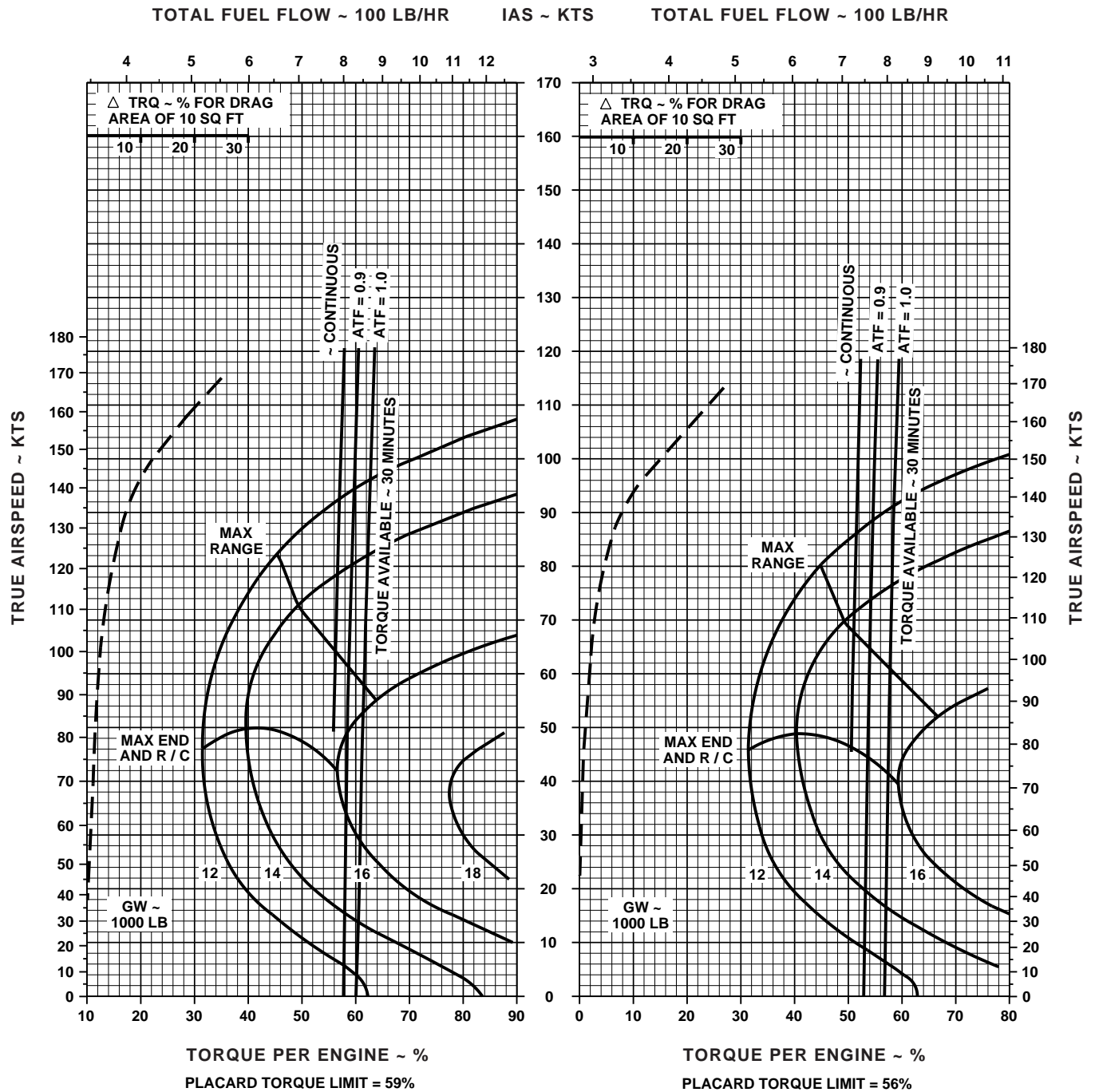

NOTE: SHORT DASH LINES: FERRY MISSION ONLY
DATA BASE: FLIGHT TEST

AA1022_4
SA

Figure 7A-28. Cruise High Drag - Pressure Altitude 18,000 Feet (Sheet 4 of 4)

CRUISE

CLEAN CONFIGURATION

PRESS ALT: 20,000 FT

CRUISE
20,000 FT
T701C (2)

-50°C

-40°C

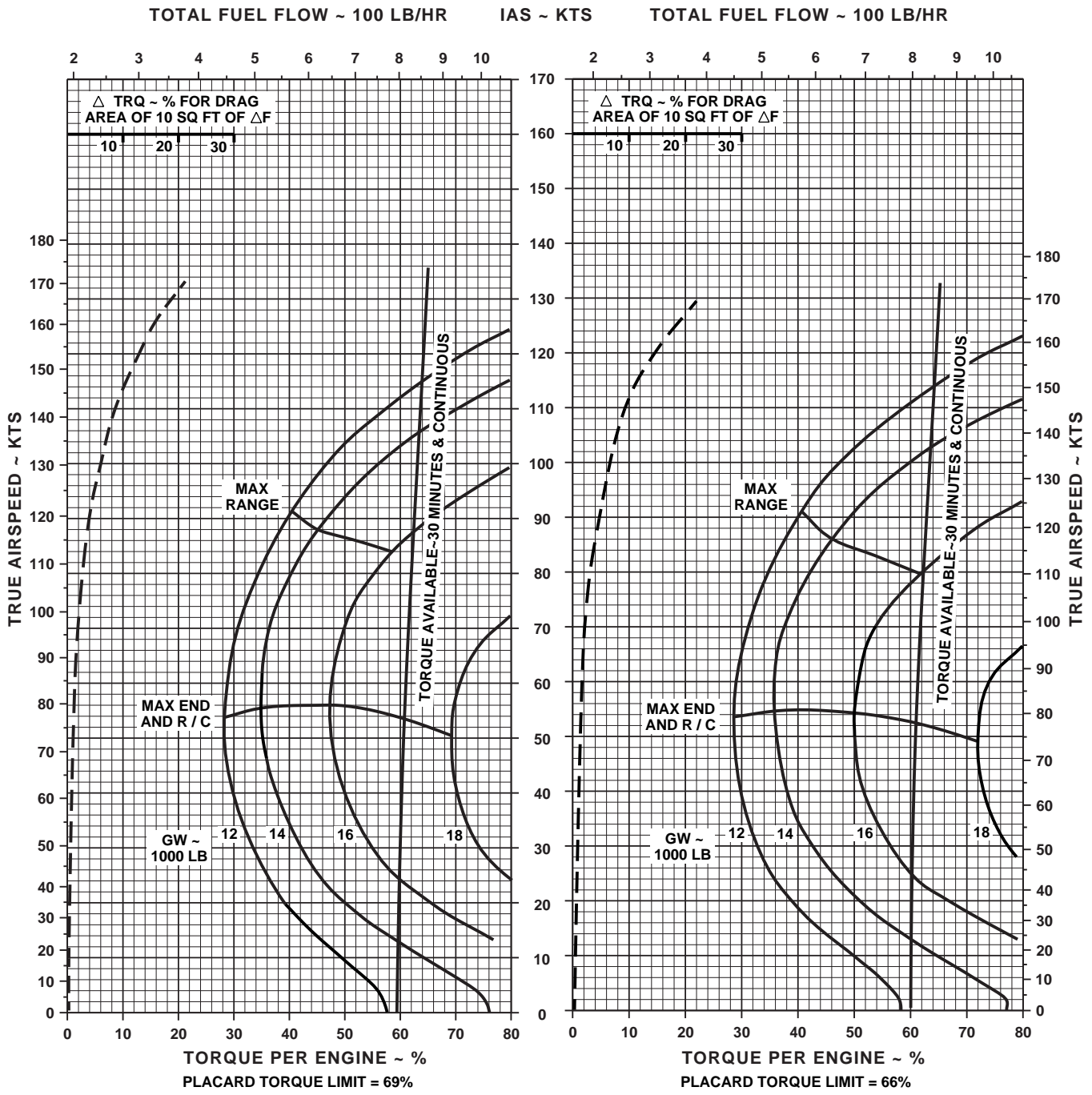

DATA BASE: FLIGHT TEST

AA1023_1
SA

Figure 7A-29. Cruise - Pressure Altitude 20,000 Feet (Sheet 1 of 4)

CRUISE

CLEAN CONFIGURATION

PRESS ALT: 20,000 FT

CRUISE
20,000 FT
T701C (2)

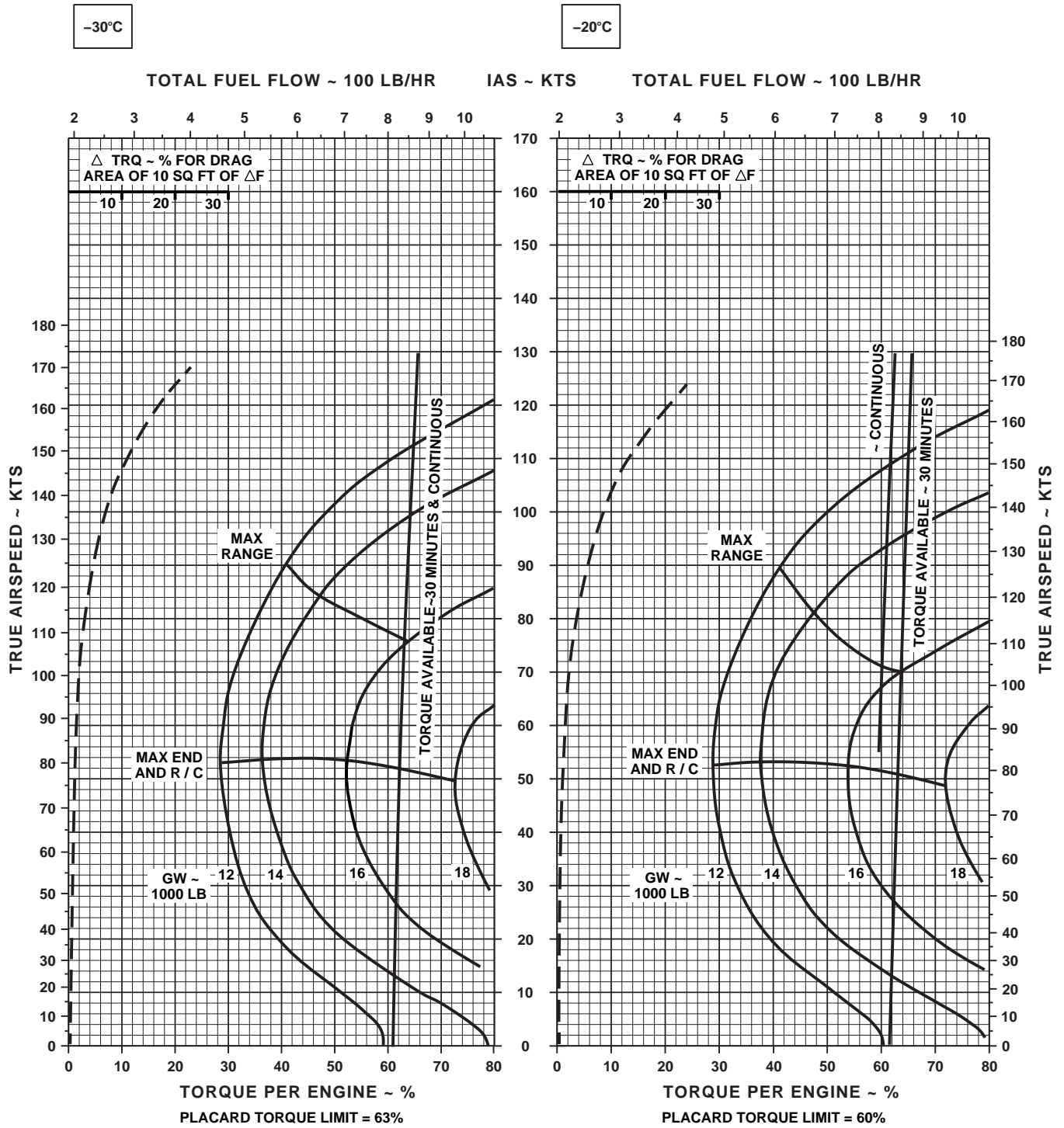

DATA BASE: FLIGHT TEST

AA1023_2
SA

Figure 7A-29. Cruise - Pressure Altitude 20,000 Feet (Sheet 2 of 4)

CRUISE

CLEAN CONFIGURATION

PRESS ALT: 20,000 FT

CRUISE
20,000 FT
T701C (2)

-10°C

0°C

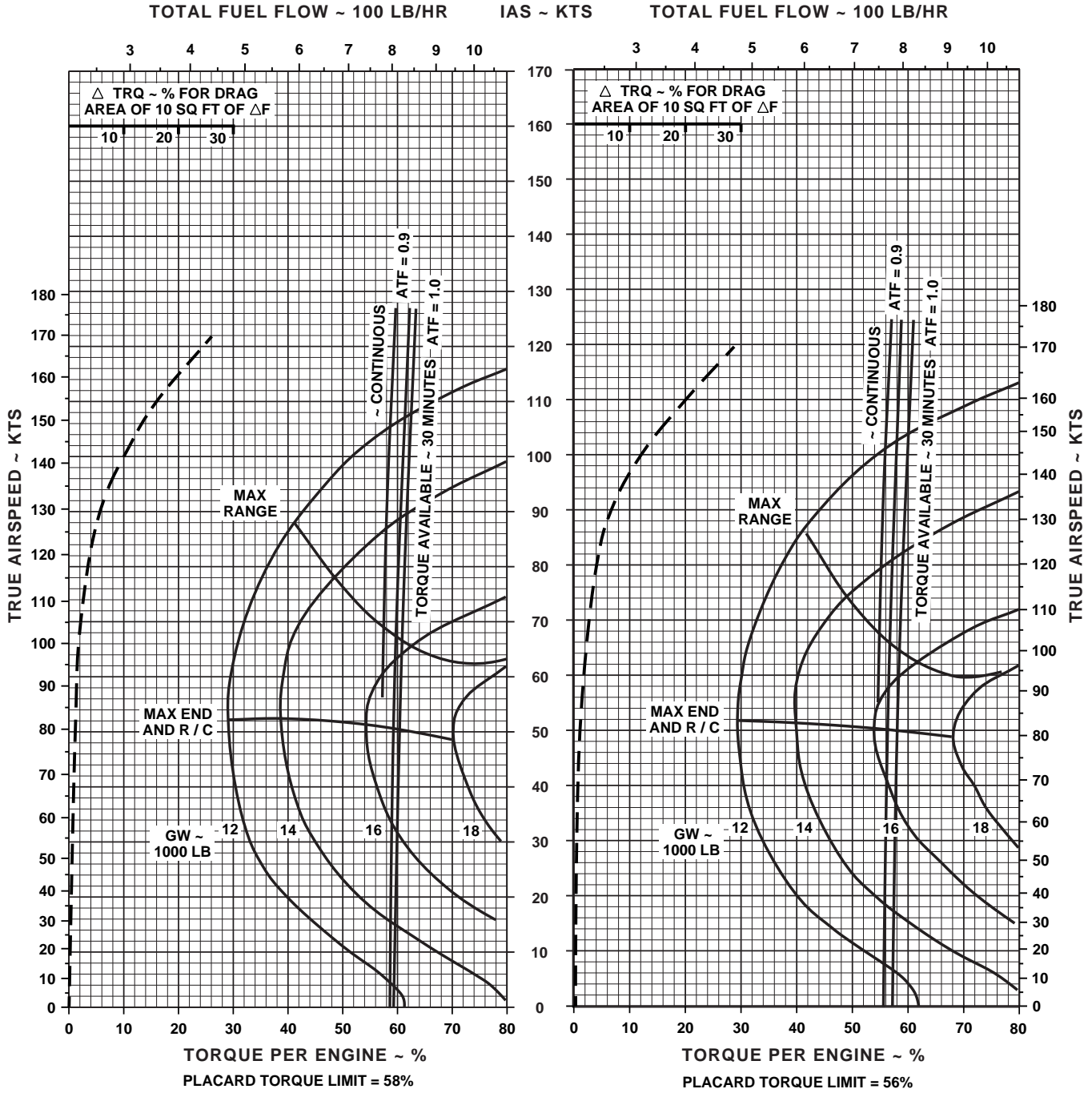

DATA BASE: FLIGHT TEST

AA1023_3
SA

Figure 7A-29. Cruise - Pressure Altitude 20,000 Feet (Sheet 3 of 4)

CRUISE

CLEAN CONFIGURATION

PRESS ALT: 20,000 FT

CRUISE
20,000 FT
T701C (2)

10°C

20°C

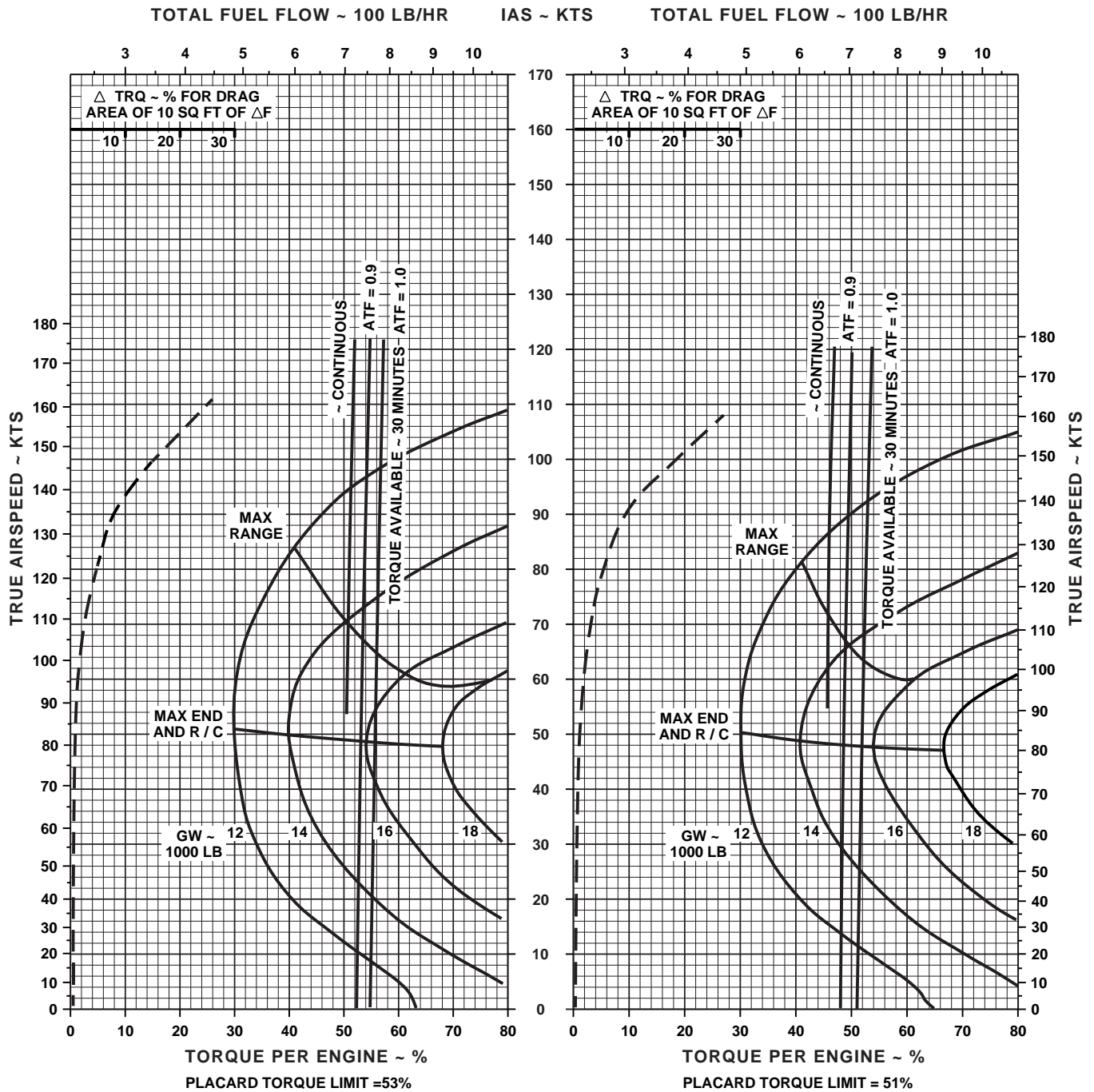

DATA BASE: FLIGHT TEST

AA1023_4
SA

Figure 7A-29. Cruise - Pressure Altitude 20,000 Feet (Sheet 4 of 4)

CRUISE

PRESS ALT: 20000 FT

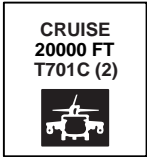

-50°C

-40°C

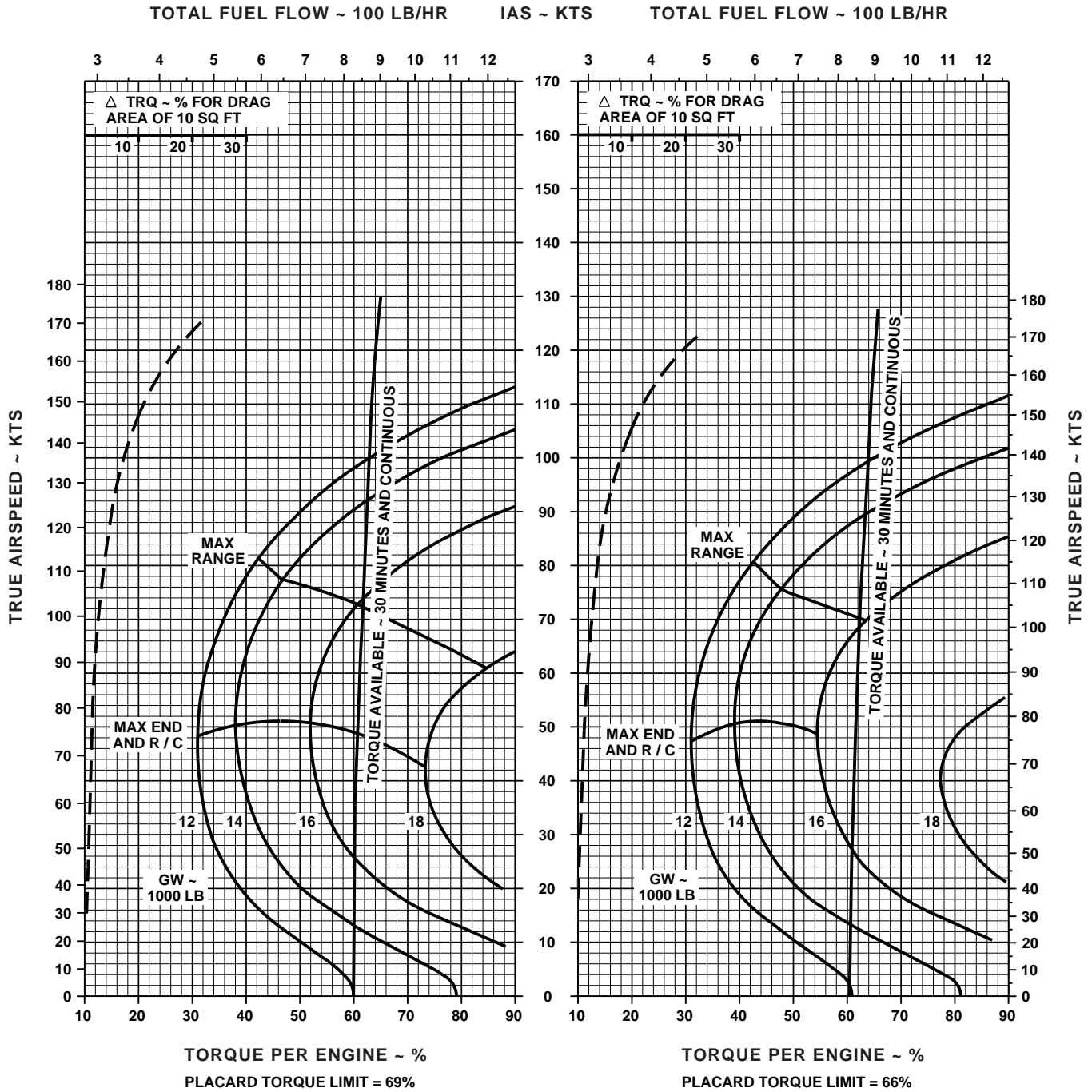

NOTE: SHORT DASH LINES: FERRY MISSION ONLY
 DATA BASE: FLIGHT TEST

AA1024_1
SA

Figure 7A-30. Cruise High Drag - Pressure Altitude 20,000 Feet (Sheet 1 of 4)

CRUISE

PRESS ALT: 20000 FT

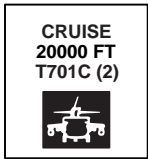

-30°C

-20°C

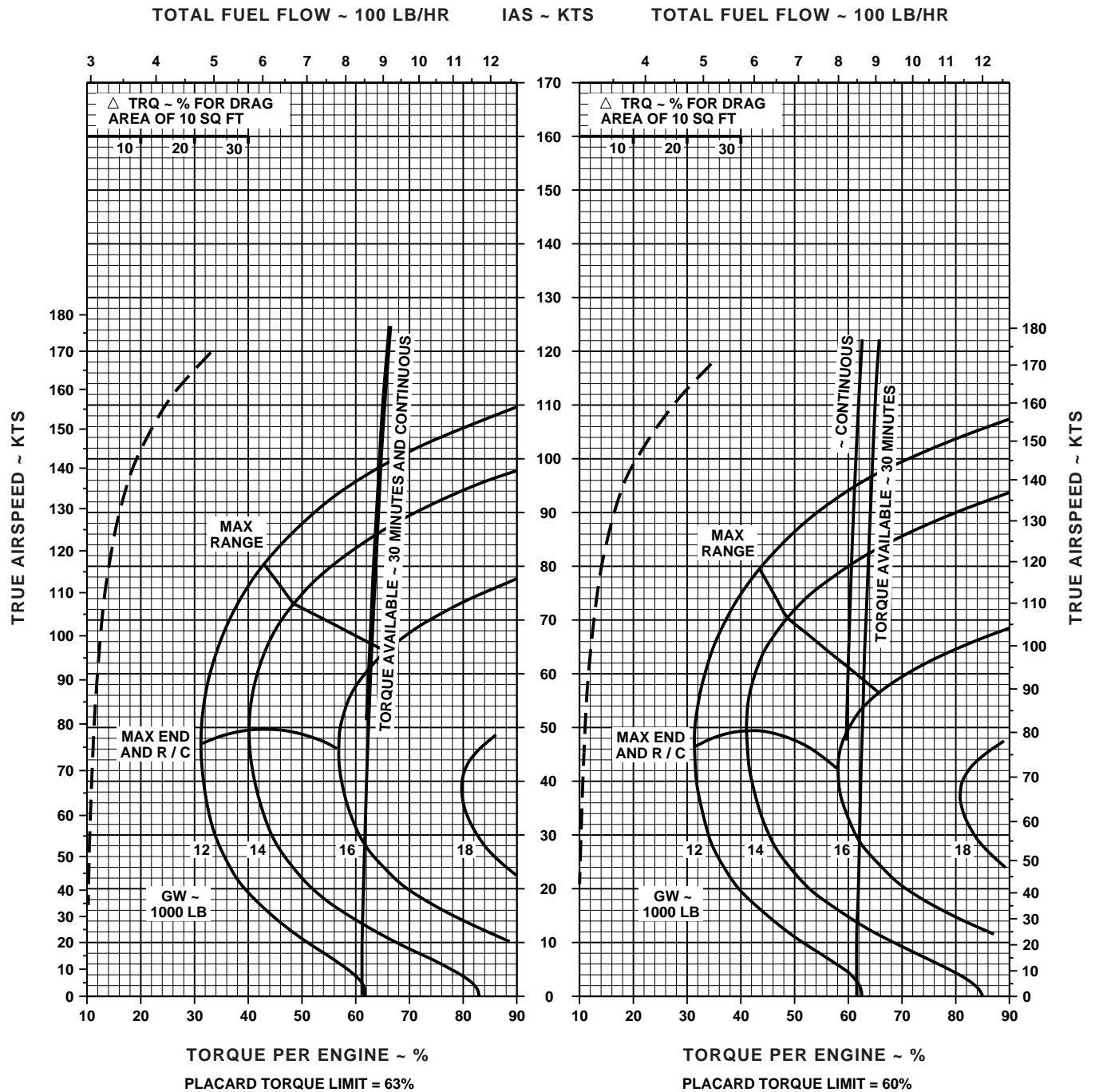

NOTE: SHORT DASH LINES: FERRY MISSION ONLY
 DATA BASE: FLIGHT TEST

AA1024_2
 SA

Figure 7A-30. Cruise High Drag - Pressure Altitude 20,000 Feet (Sheet 2 of 4)

CRUISE

PRESS ALT: 20000 FT

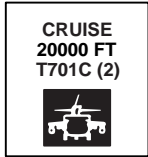

-10°C

0°C

TOTAL FUEL FLOW ~ 100 LB/HR

IAS ~ KTS

TOTAL FUEL FLOW ~ 100 LB/HR

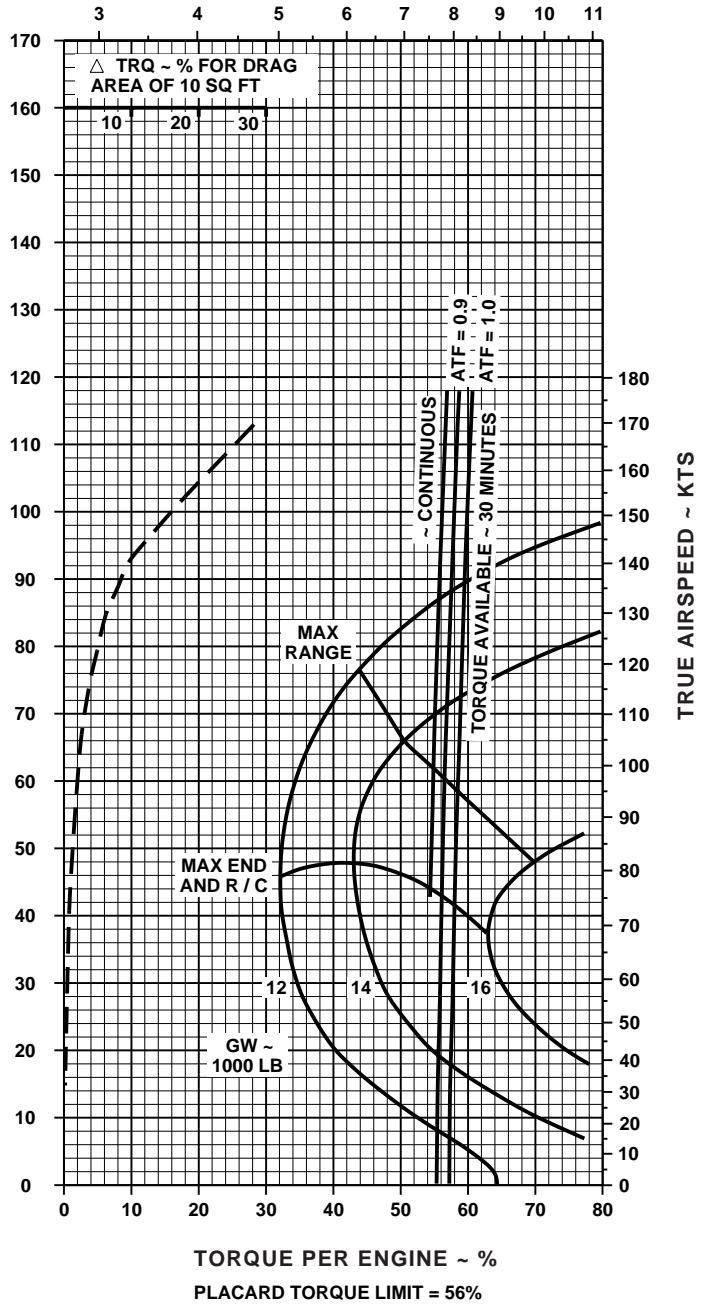
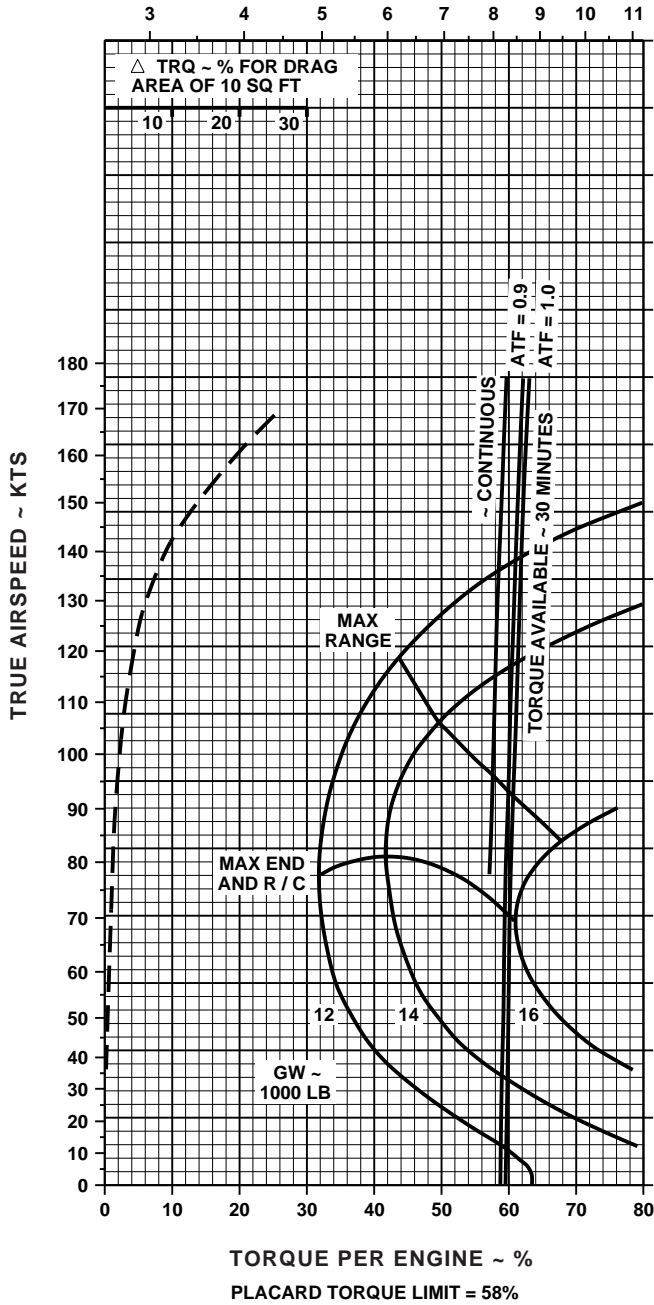

NOTE: SHORT DASH LINES: FERRY MISSION ONLY
 DATA BASE: FLIGHT TEST

AA1024_3
 SA

Figure 7A-30. Cruise High Drag - Pressure Altitude 20,000 Feet (Sheet 3 of 4)

CRUISE

PRESS ALT: 20000 FT



10°C

20°C

TOTAL FUEL FLOW ~ 100 LB/HR

IAS ~ KTS

TOTAL FUEL FLOW ~ 100 LB/HR

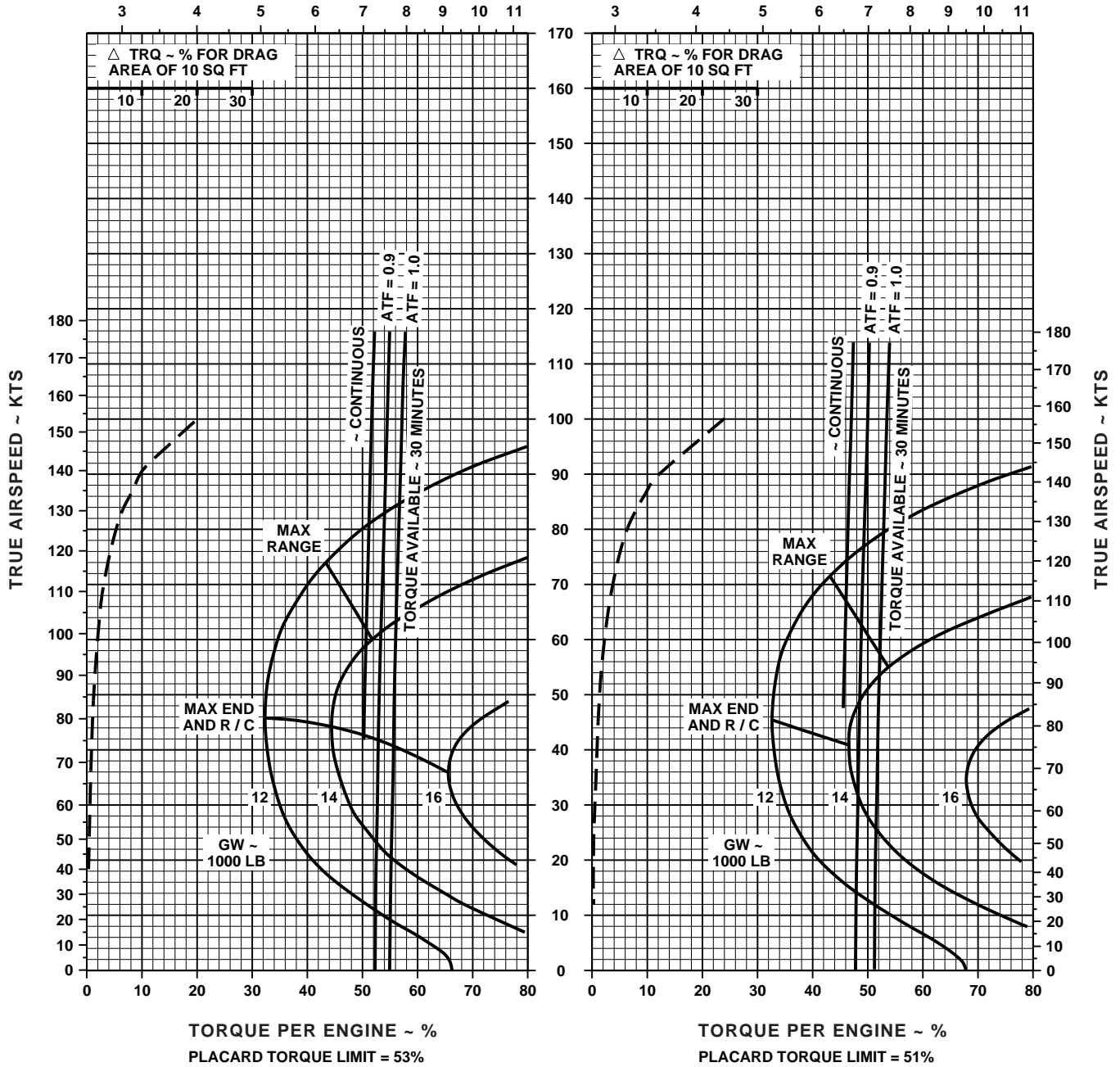

NOTE: SHORT DASH LINES: FERRY MISSION ONLY
 DATA BASE: FLIGHT TEST

AA1024_4
 SA

Figure 7A-30. Cruise High Drag - Pressure Altitude 20,000 Feet (Sheet 4 of 4)

Section V OPTIMUM CRUISE

7A.20 OPTIMUM RANGE CHARTS.

This section presents a method to optimize cruise performance for long range missions when the altitudes flown are not restricted by other requirements. The optimum altitude for maximum range charts (Figures 7A-31 and 7A-32) provides the pressure altitude at which to cruise to obtain the maximum possible range for any gross weight and FAT conditions. The altitude determined for optimum range may

also be used for optimum endurance. Enter the chart at a current cruise or takeoff temperature condition and move along the temperature guide lines to the anticipated gross weight for cruise and obtain the optimum pressure altitude. Turn to the cruise chart closest to the altitude and temperature predicted by the optimum range chart for specific cruise information. The use of this chart is shown by the example.

OPTIMUM RANGE

CLEAN CONFIGURATION 100% RPM R HIRSS (BAFFLES INSTALLED)

GROSS WEIGHT ~ 1000 LB

EXAMPLE

WANTED

CRUISE ALTITUDE FOR OPTIMUM RANGE
AND CORRESPONDING CRUISE CHART FOR
FLIGHT CONDITIONS

KNOWN

REFERENCE CONDITIONS OF:
PRESSURE ALTITUDE = 1,500 FT
FAT = 24°C
GW = 16,600 LB

METHOD

ENTER CHART AT FAT (24°C). MOVE
RIGHT TO REFERENCE / OPTIMUM
PRESSURE ALTITUDE (1,500 FT). MOVE
PARALLEL WITH THE TEMPERATURE
TREND LINE TO AIRCRAFT GROSS
WEIGHT (16,600 LB). MOVE LEFT
OR RIGHT PARALLELING THE
TEMPERATURE TREND LINE TO
THE NEAREST EVEN THOUSAND
REFERENCE / OPTIMUM PRESSURE
ALTITUDE LINE (12,000). MOVE
LEFT TO FREE AIR TEMPERATURE
LINE (3°). MOVE UP OR DOWN
TO NEAREST TEN VALUE ON THE
FREE AIR TEMPERATURE SCALE (0°C).

SELECT CRUISE CHART WITH
ALTITUDE AND TEMPERATURE
DATA AT THE NEAREST REFERENCE /
OPTIMUM PRESSURE ALTITUDE
(12,000 FT) AND THE NEAREST
TEN DEGREE FREE AIR TEMPERATURE
(0°C).

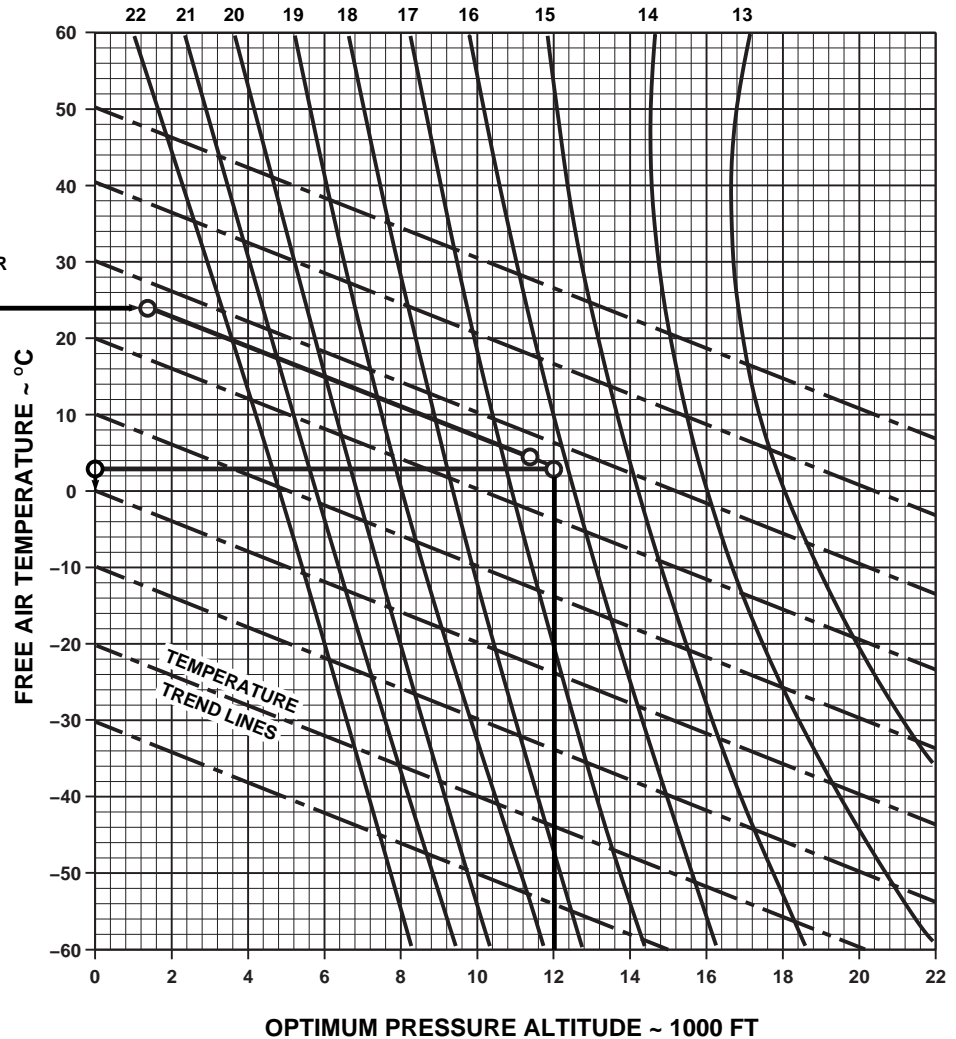

DATA BASIS: FLIGHT TEST

AA1256B
SA

Figure 7A-31. Optimum Altitude For Maximum Range

OPTIMUM RANGE

HIGH DRAG CONFIGURATION 100% RPM R

HIRSS (BAFFLES INSTALLED)

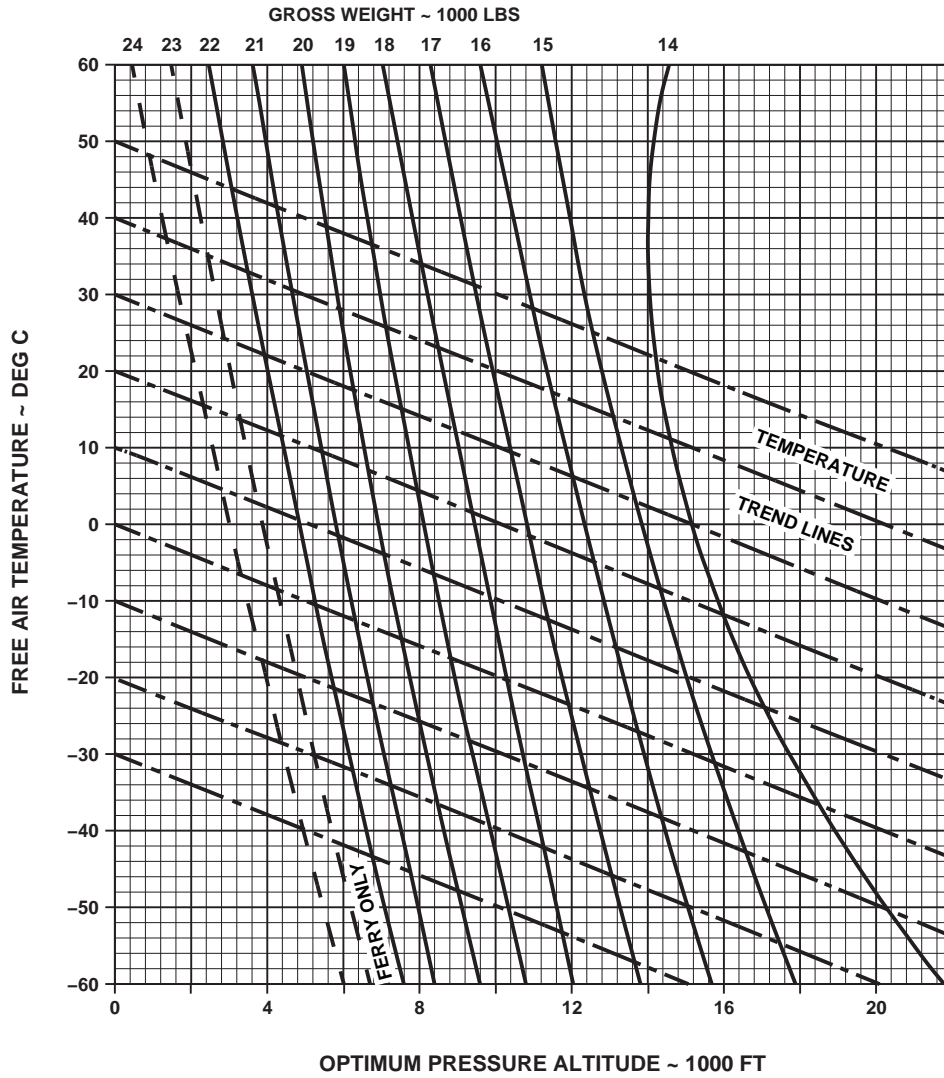

AA1026A
SA

Figure 7A-32. Optimum Altitude For Maximum Range - High Drag

Section VI DRAG

7A.21 EXTERNAL LOAD DRAG CHART.

The general shapes of typical external loads are shown on Figure 7A-33. as a function of the load frontal area. The frontal area is combined with the typical drag coefficient of the general shapes to obtain a drag multiplying factor for use with the 10 sq. ft. drag scale on each cruise chart. The ΔTRQ % value obtained from the cruise chart is multiplied by the drag multiplying factor and added to indicated torque to obtain total torque required at any airspeed.

7A.22 AIRCRAFT CONFIGURATION DRAG CHANGES FOR USE WITH CLEAN CRUISE CHARTS.

When external equipment or configuration differs from the baseline clean configuration as defined in Section I, a drag correction should be made similarly to the external drag load method. Typical configuration changes that have drag areas established from flight test or analysis along with their drag multiplying factor are listed in Table 7A-1.

Table 7A-1. Configuration Drag Change

DRAG CHANGES FOR USE WITH CLEAN CRUISE CHARTS		
Item	Change in Flat Plate Drag Area - ΔF Sq. Ft.	Drag Multiplying Factor
a. Both cargo doors open	6.0	0.60
b. Cargo doors removed	4.0	0.40
c. Cargo mirror installed	0.3	0.03
d. IR Countermeasure Transmitter (ALQ-144) installed	0.8	0.08
e. Chaff Dispenser installed	0.3	0.03
f. Blade Erosion Kit	2.0	0.20
g. Skis installed	3.0	0.30

7A.23 AIRCRAFT CONFIGURATION DRAG CHANGES FOR USE WITH HIGH DRAG CRUISE CHARTS.

When external equipment differs from the baseline high drag configuration as defined in this Section, a drag correction should be made using Figure 7A-34 similar to the ex-

ternal drag load method. Typical high drag configuration changes that have been established from flight test or analysis along with the drag multiplying factors are shown.

EXTERNAL DRAG LOAD

EXAMPLE

WANTED:
DRAG MULTIPLYING FACTOR
DUE TO EXTERNAL LOAD

KNOWN:
SHAPE OF EXTERNAL
LOAD = CYLINDER
FRONTAL AREA OF
EXTERNAL LOAD = 80 SQ FT

METHOD:
ENTER CHART AT SYMBOL
FOR CYLINDER
MOVE RIGHT TO 80 SQ FT.
MOVE DOWN AND READ
DRAG MULTIPLYING FACTOR
= 4.5

LOAD
DRAG

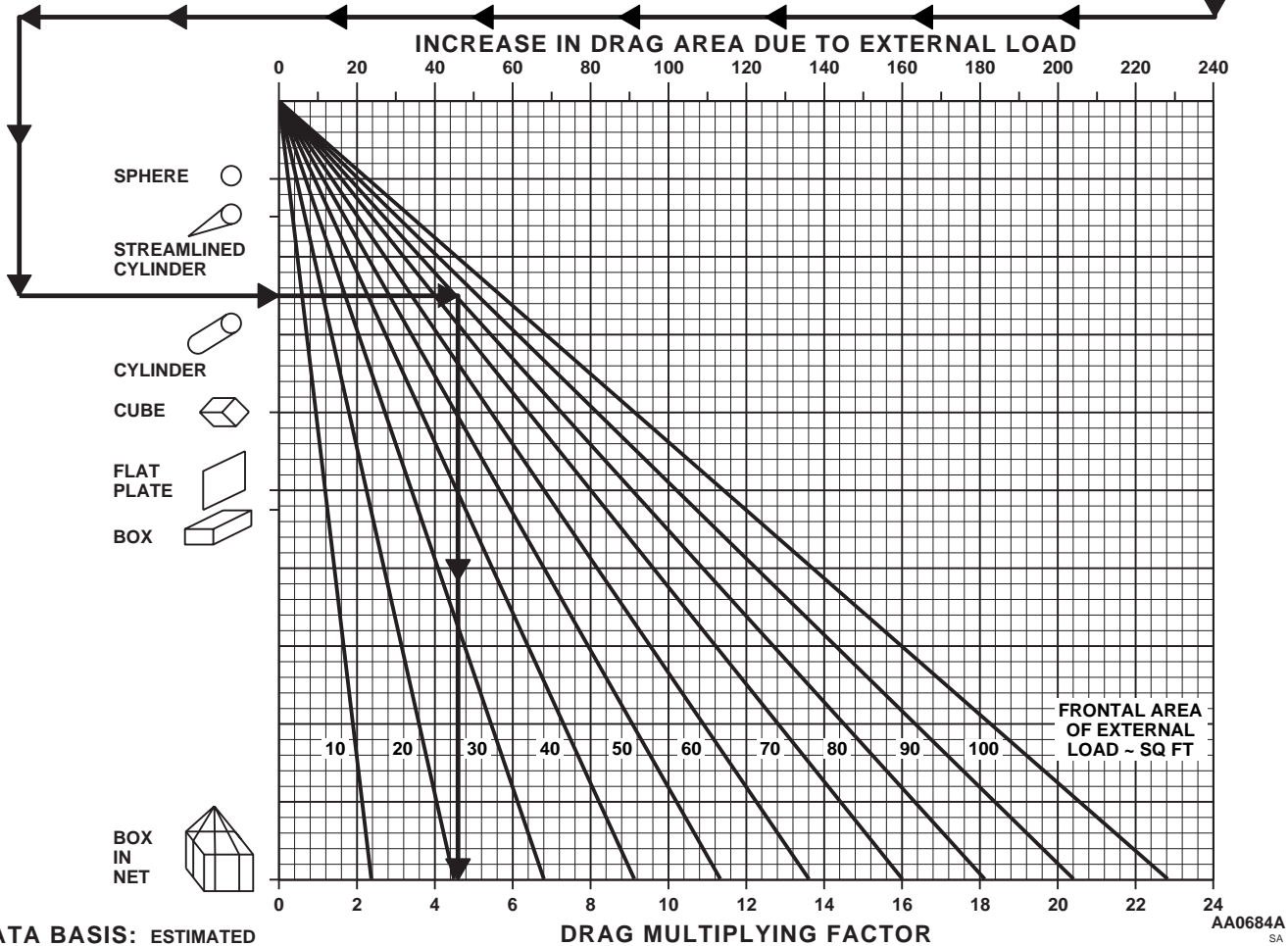

Figure 7A-33. External Load Drag

DRAG CONFIGURATIONS



	<p style="text-align: center;">HIGH DRAG CRUISE CHART BASELINE SPECIAL MISSION EQUIPMENT CONFIGURATIONS</p>	<p style="text-align: center;">CHANGE IN FLAT PLATE DRAG ΔF SQ FT</p>	<p style="text-align: center;">DRAG MULTI- PLYING FACTOR</p>
	<p style="text-align: center;">ESSS - CLEAN, PYLONS REMOVED</p>	-4.0	-0.40
	<p style="text-align: center;">ESSS - FOUR PYLONS / NO STORES</p>	-1.7	-0.17
	<p style="text-align: center;">ESSS-TWO 450-GALLON TANKS INBOARD -TWO 230-GALLON TANKS INBOARD</p>	0.5 0.0	0.05 0.00
	<p style="text-align: center;">ESSS-TWO 230-GALLON TANKS OUTBOARD -TWO 450-GALLON -TANKS INBOARD</p>	2.5	0.25
	<p style="text-align: center;">ESSS - FOUR 230-GALLON TANKS</p>	2.0	0.20
	<p style="text-align: center;">VOLCANO SYSTEM INSTALLED (BOTH RACKS) * VOLCANO CORRECTION MUST BE USED WITH HIGH DRAG CHARTS ONLY VOLCANO SYSTEM INSTALLED (LOWER RACKS ONLY)</p>	32.5 10.5	3.25 1.05
	<p style="text-align: center;">SKIS INSTALLED</p> <p style="text-align: center;">BOTH CARGO DOORS OPEN</p> <p style="text-align: center;">BOTH CARGO DOORS REMOVED</p> <p style="text-align: center;">CARGO MIRROR INSTALLED</p> <p style="text-align: center;">IR COUNTERMEASURE TRANSMITTER (ALQ-144) REMOVED</p> <p style="text-align: center;">CHAFF DISPENSER REMOVED</p>	3.0 6.0 4.0 0.3 -0.8 -0.3	0.30 0.60 0.40 0.03 -0.08 -0.03

AA0685B
SA

Figure 7A-34. Typical High Drag Configurations

Section VII CLIMB-DESCENT

7A.24 CLIMB/DESCENT CHART.

The CLIMB/DESCENT chart (Figures 7A-35 and 7A-36) presents the rate of climb or descent resulting from an increase or decrease of engine torque from the value required for level flight above 40 KIAS. The data are presented at 100% RPM R for various gross weights. The charts may also be used in reverse to obtain the torque

increase or reduction required to achieve a desired steady rate of climb or descent. The maximum R/C may be determined by subtracting the cruise chart torque required from the maximum torque available at the desired flight conditions. Then enter the difference on the torque increase scale of the climb chart, move up to the gross weight, and read the resulting maximum R/C.

CLIMB/DESCENT

100% RPM R CLEAN CONFIGURATION

CLIMB/DESCENT

FOR AIRSPEED ABOVE 40 KIAS

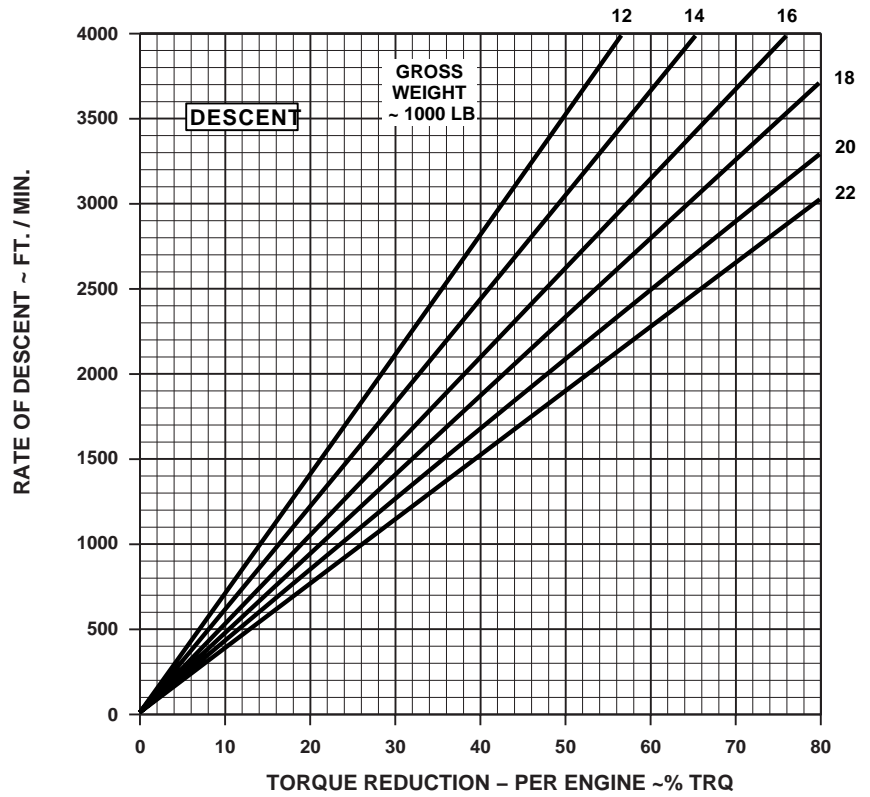

EXAMPLE

ENTER AT 1000 FT / MIN
 MOVE RIGHT TO 20,000 LB
 MOVE DOWN READ TRQ
 INCREASE = 28%

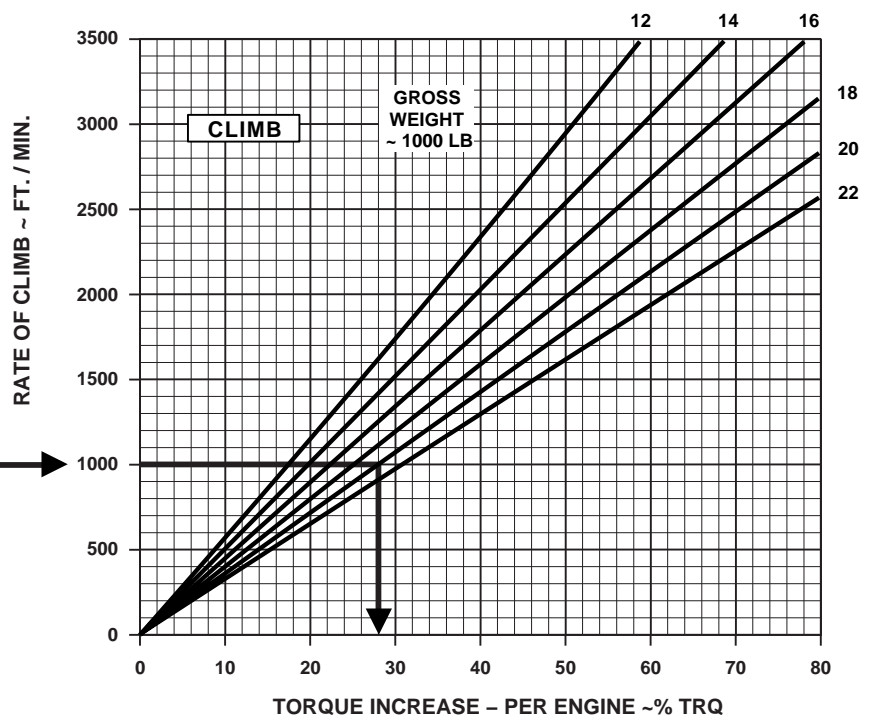

DATA BASIS: FLIGHT TEST

AA1638
SA

Figure 7A-35. Climb/Descent

CLIMB DESCENT

100% RPM R
FOR AIRSPEED ABOVE 40 KIAS

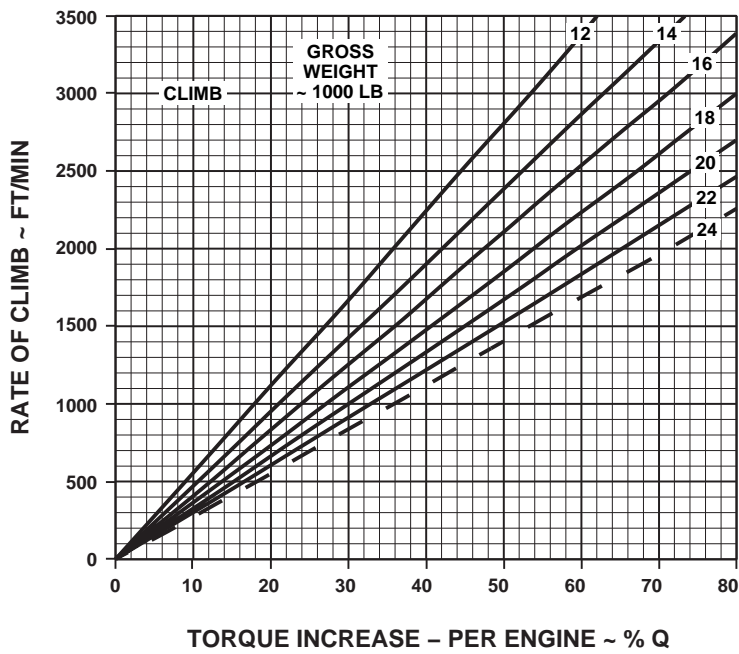
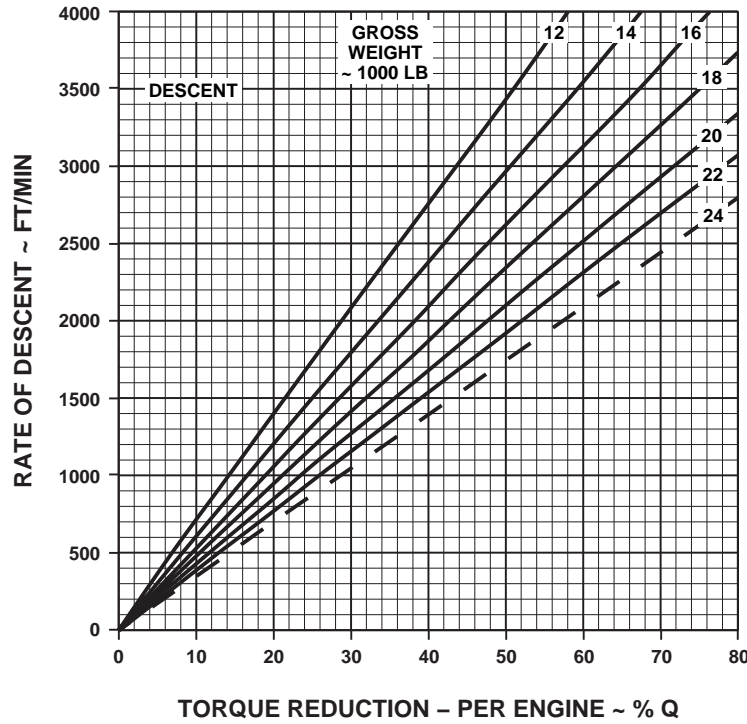
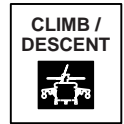

DATA BASIS: FLIGHT TEST

AA1027
SA

Figure 7A-36. Climb/Descent - High Drag

Section VIII FUEL FLOW

7A.25 IDLE FUEL FLOW.

Dual-engine idle fuel flow is presented as a function of altitude at 0°C FAT in Table 7A-2.

7A.26 SINGLE-ENGINE FUEL FLOW.

Engine fuel flow is presented in Figure 7A-37 for various torque and pressure altitudes at a baseline FAT of 0°C with engine bleed air extraction off. When operating at other than 0°C FAT, engine fuel flow is increased 1% for each 20°C above the baseline temperature and, decreased 1% for each 20°C below the baseline temperature.

To determine single-engine fuel flow during cruise, enter the fuel flow chart at double the torque required for dual-engine cruise as determined from the cruise charts and obtain fuel flow from the single-engine scale. The single-engine torque may not exceed the transmission limit shown on the chart. With bleed air extracted, fuel flow increases as follows:

- a. Engine anti-ice on - +50 lbs/hr.
- b. Cockpit heater on - +6 lbs/hr.

c. When the IR suppressor system is operating in the benign mode (exhaust baffles removed), the fuel flow will decrease about 7 lbs/hr.

7A.27 DUAL-ENGINE FUEL FLOW.

Dual-engine fuel flow may be obtained from Figure 7A-37 when each engine is indicating approximately the same torque by averaging the indicated torques and reading fuel flow from the dual-engine fuel flow scale. When operating at other than the 0° FAT baseline, dual-engine fuel flow is increased 1% for each 20°C above baseline and is decreased 1% for each 20°C below baseline temperature. With bleed air extracted, dual engine fuel flow increases as follows:

- a. Engine anti-ice on - +100 lbs/hr.
- b. Cockpit heater on - +12 lbs/hr.

c. When the IR suppressor system is operating in the benign mode (exhaust baffles removed), the fuel flow decreases about 14 lbs/hr.

Table 7A-2. Idle Fuel Flow

Pressure Altitude Feet	Ng = 63-71%	Ng = 79-88%	APU (Nominal) Lb/Hr
	Ground Idle (66% RPM R) Lb/Hr	Flat Pitch (100% RPM R) Lb/Hr	
0	360	590	120
4,000	310	515	105
8,000	280	445	90
12,000	250	400	75
16,000	220	340	65
20,000	185	280	55

SINGLE/DUAL-ENGINE FUEL FLOW

HIRSS SUPPRESSED MODE BLEED AIR OFF

100% RPM R FAT= 0° C

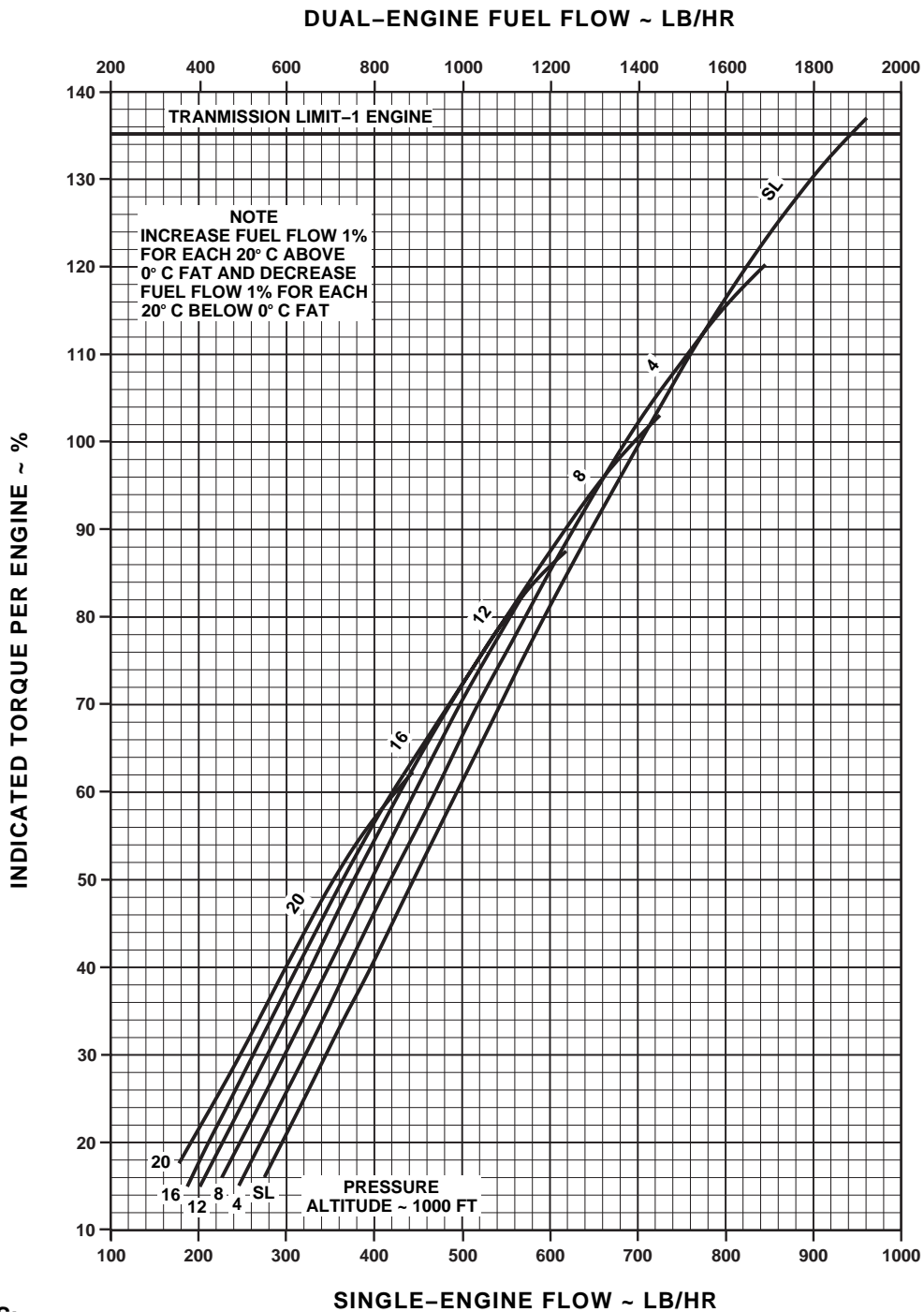

DATA BASIS:
ENGINE MANUFACTURER
SPEC.

AA1028A
SA

Figure 7A-37. Single/Dual-Engine Fuel Flow

Section IX AIRSPEED SYSTEM CHARACTERISTICS

7A.28 AIRSPEED SYSTEM DESCRIPTION.

NOTE

Indicated airspeeds below 40 KIAS are unreliable. Airspeed conversion data KIAS to KTAS for speeds above 40 KIAS are provided in Section IV CRUISE.

The UH-60L is equipped with the pitot-static system with wedge mounted pitot-static probes.

7A.29 AIRSPEED CHARTS.

7A.29.1 Airspeed Correction Charts. All indicated airspeeds shown on the cruise charts are based on level flight. Figures 7A-38 and 7A-39 provide the airspeed correction to be added to the cruise chart IAS value to determine the related airspeed indicator reading for other than level flight mode. There are relatively large variations in airspeed system error associated with climbs and descents. These errors are significant and Figures 7A-38 and 7A-39 are provided primarily to show the general magnitude and direction of the errors associated with the various flight modes. If desired these figures may be used in the manner shown by the examples to calculate specific airspeed corrections.

7A.29.2 Airspeed System Dynamic Characteristics. The dynamic characteristics of the pilot and copilot airspeed indicating systems are normally satisfactory. However, the following anomalies in the airspeed and IVSI indicating system may be observed during the following maneuvers or conditions:

a. During takeoffs, in the speed range of 40 to 80 KIAS, 5 to 10 KIAS airspeed fluctuation may be observed on the pilot's and copilot's airspeed indicators.

b. Power changes in high power, low airspeed climbs may cause as much as 30 knot airspeed changes in indicated airspeed. Increase in power causes increase in indicated airspeed, and a decrease in power causes decrease in indicated airspeed.

c. The pilot and copilot airspeed indicators may be unreliable during high power climbs at low airspeeds (less than 50 KIAS) with the copilot system reading as much as 30 knots lower than the pilot system.

d. In-flight opening and closing of doors and windows may cause momentary fluctuations of approximately 300 feet per minute on the vertical speed indicators.

AIRSPEED SYSTEM CORRECTION

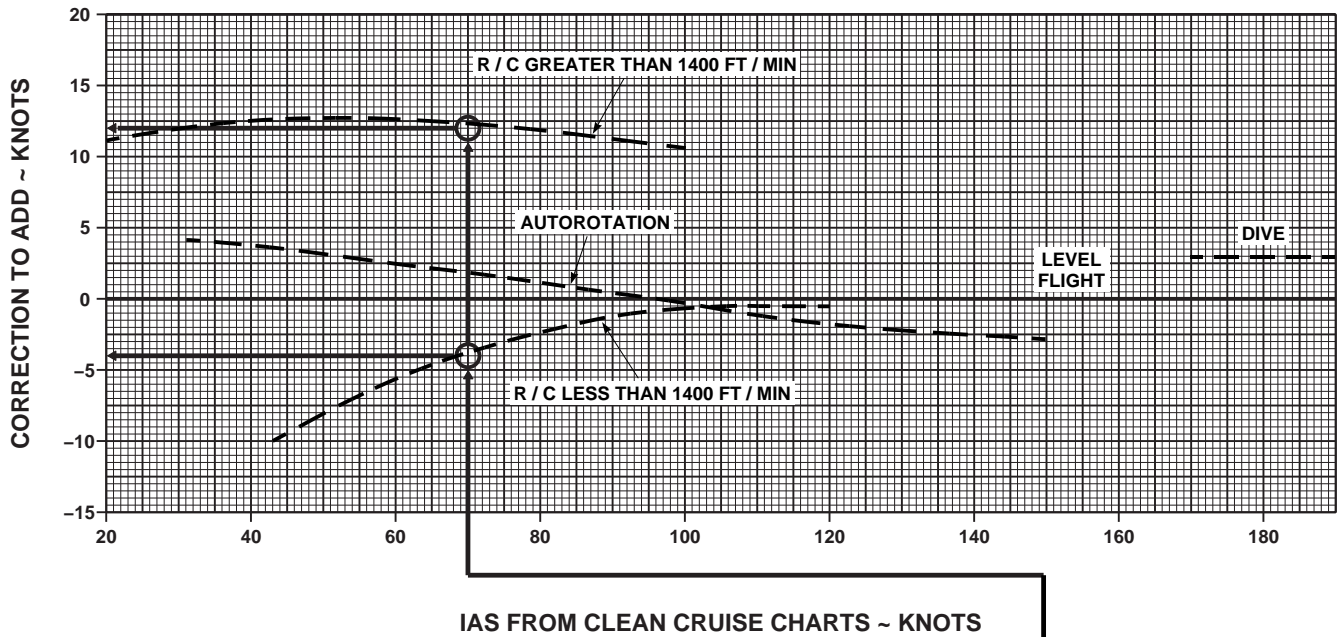

EXAMPLE

WANTED:

INDICATED AIRSPEED TO CLIMB AT
MAXIMUM RATE OF CLIMB.

KNOWN:

70 KIAS MAX END / AND R / C FROM
APPROPRIATE CRUISE CHART FOR
A GIVEN PRESSURE ALTITUDE, FAT,
AND GROSS WEIGHT.

METHOD:

ENTER AT KNOWN IAS FROM
CRUISE CHART, MOVE UP TO R / C GREATER
THAN 1,400 FPM, MOVE LEFT READ CORRECTION
TO ADD TO IAS = +12.5 KTS, RE-ENTER
AT KNOWN IAS FROM CRUISE CHART, MOVE UP
TO R / C LESS THAN 1,400 FPM LINE, MOVE LEFT,
READ CORRECTION TO ADD TO IAS = -4 KTS
CALCULATE IAS FOR MAX R / C WHEN:

FOR R / C GREATER THAN 1,400 FPM, AIRSPEED = 70 KIAS +12.5 KIAS = 82.5 KIAS

FOR R / C LESS THAN 1,400 FPM, AIRSPEED = 70 KIAS -4 KIAS = 66 KIAS

DATA BASIS: FLIGHT TEST

AA0321A
SA

Figure 7A-38. Airspeed Correction Chart

AIRSPEED SYSTEM CORRECTION

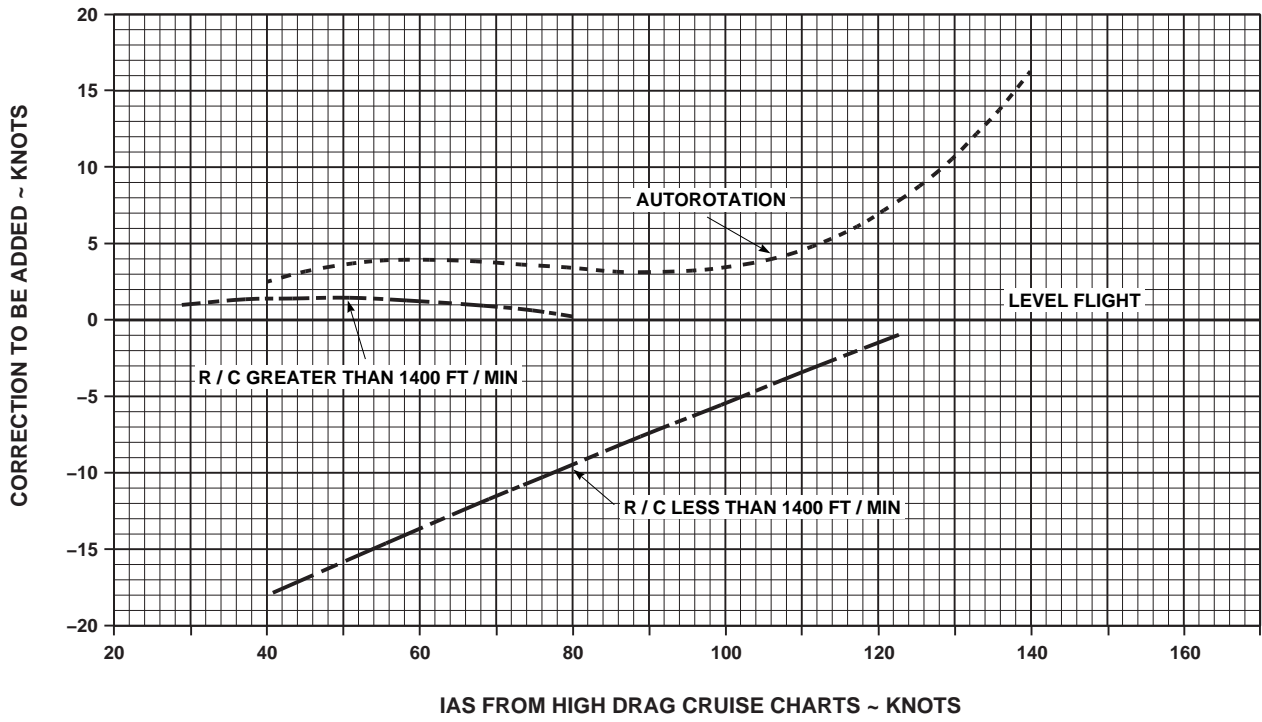

DATA BASIS: FLIGHT TEST

AA1029A
SA

Figure 7A-39. Airspeed Correction Chart - High Drag

Section X SPECIAL MISSION PERFORMANCE

7A.30 SPECIAL MISSION FLIGHT PROFILES.

Figures 7A-40 through 7A-42 show special mission flight profiles required to obtain near maximum range when equipped with the ESSS in three different tank configurations. The upper segment of each chart provides the recommended altitude profile along with the IAS and average TRQ versus distance traveled. An average value of elapsed time is also presented on the lower axis of the altitude scale. The lower segment of each chart provides the relationship between fuel remaining and distance traveled resulting from the flight profile shown. This portion may be utilized to check actual inflight range data to provide assurance that adequate range is being achieved. The chart is divided into 3 regions of Adequate Range, Inadequate range-return to base, and Inadequate range-requiring emergency action. When an inflight range point is in the Adequate range region, the required mission range can be obtained by staying on the recommended flight profile. However, the range may not be achieved if stronger headwinds are encountered as the flight progresses, and normal pilot judgement must be used. These charts also assume that the flight track is within proper navigational limits. Standard temperature variation with PA is shown on the upper segment of the charts. A general correction for temperature variation is to decrease IAS by 2.5 KTS and total distance traveled by 0.5% for each 10°C above standard. Detailed flight planning must always be made for the actual aircraft configuration, fuel load, and flight conditions when maximum range is required. This data is based on JP-4 fuel. It can be used with JP-5, JP-8, aviation gasoline, or any other fuels **ONLY IF THE TAKEOFF GROSS WEIGHT AND THE FUEL LOAD WEIGHT MATCH THE DATA AT THE TOP OF THE CHART**. The Flight Time and the Distance Traveled data **SHOULD NOT** be used with any full tank configuration if the fuel density is not approximately 6.5 lb/gal (JP-4 fuel).

a. **SELF-DEPLOYMENT MISSION.** The self-deployment mission is shown in Figure 7A-40 and the ESSS is configured with two 230-gallon tanks outboard and two 450-gallon tanks inboard. In this configuration, the aircraft holds in excess of 11,000 lb of JP4 fuel and has a take-off gross weight of 24,500 pounds in order to achieve the desired mission range of 1,150 Nm. This gross weight is allowed for ferry missions only, requiring low load fac-

tors and less than 30 degree angle banked turns. This mission was calculated for a standard day with a constant 10 knot headwind added to be conservative. Since there may not be any emergency landing areas available, the mission should not be attempted if headwinds in excess of 10 knots are forecast. Take-off must be made with a minimum of fuel used (60 pounds) for engine start and warm-up, and a climb to 2,000 feet should be made with maximum power and airspeed between 80 and 105 KIAS. The first segment should be maintained at 2,000 feet and 105 KIAS for 2 hours. The average engine TRQ should be about 79% for this segment, but will initially be a little more and gradually decrease. Altitude is increased in 2,000 feet increments to maintain the optimum altitude for maximum range to account for fuel burn. The first 2 segments are for 2 hours each, followed by 1 hour segments until reaching 10,000 feet. At this altitude, the airspeed for best range should also be reduced to 100 KIAS for the remainder of the flight. Engine bleed air was assumed to be off for this mission except for that required for fuel tank pressurization. Electrical cabin heat may be used. Removal of the HIRSS baffles (benign mode) will reduce fuel flow by about 14 lb/hr. If oxygen is available, continuation of the staircase climb sequence to 15,500 feet PA will result in about 23 additional Nm of range capability.

b. **ASSAULT MISSION PROFILE - 4 tanks.** The assault mission profile is shown in Figure 7A-41 with the ESSS configured with four 230-gallon tanks. In this configuration, the aircraft holds in excess of 8,300 pounds of JP4 fuel and assumes a take-off gross weight of 22,000 pounds which provides a maximum mission range of 980 Nm with 400 lbs reserve. This mission was calculated for a standard day with a zero headwind. Take-off must be made with a minimum of fuel used (80 pounds) for engine start and warm-up, and a climb to 4,000 feet should be made with maximum power and airspeed between 80 and 108 KIAS. The first segment should be maintained at 4,000 feet and 108 KIAS for 1 hour. The average engine TRQ should be about 79% for this segment, but will initially be a little more and gradually decrease. Altitude is increased in 2,000 feet increments to maintain the optimum altitude for maximum range to account for fuel burn. The segments are for 1 hour each, until reaching 10,000 feet. At this altitude, the airspeed for best range should be reduced to 100 KIAS for the remainder of the flight.

c. ASSAULT MISSION PROFILE – 2 tanks. The assault mission profile is shown in Figure 7A-42 with the ESSS configured with two 230-gallon tanks. In this configuration, the aircraft holds in excess of 5,300 pounds of JP4 fuel and assumes a take-off gross weight of 22,000 pounds which provides a maximum mission range of 580 Nm. with 400 lbs reserve. This mission was calculated for a standard day with a zero headwind. Take-off must be made with a minimum of fuel used (80 lbs) for engine start and warm-up, and a climb to 4,000 feet should be made with

maximum power and airspeed between 80 and 108 KIAS. The first segment should be maintained at 4,000 feet and 108 KIAS for 1 hour. The average engine TRQ should be about 77% for this segment, but will initially be a little more and gradually decrease as shown on each segment. Altitude is increased in 2,000 foot increments to maintain the optimum altitude for maximum range to account for fuel burn. At this altitude, the airspeed for best range should also be reduced to 100 KIAS for the remainder of the flight.

EXAMPLE:

WANTED:

Assurance of adequate aircraft range for mission defined.

KNOWN:

Flight position: 300 nm from base
Flight Track Within Limits
Fuel Remaining = 7,900 pounds
Elapsed flight time = 2 HRS, 50 MINS (2.83 HRS)
Target: Normal Flight Conditions:

Airspeed = 105 KIAS
Press Alt = 2,000 feet
Approx Torque = 74%

METHOD:

- (1) Enter chart at total distance flown and at fuel remaining, move to intersection and plot point. If point falls on or above fuel remaining line (adequate range), remaining fuel is adequate to complete the mission. If point falls below the fuel remaining line in the inadequate range, abort mission region, immediately return to departure point while continuing to utilize altitude profile using total elapsed flight time (see item 2). If point falls below the fuel remaining line in the inadequate range, region, consult emergency procedures for corrective action.
- (2) To determine target nominal flight conditions, enter upper chart at elapsed flight time and move up to determine target airspeed, approximate torque, and pressure altitude.

Figure 7A-40. Self Deployment Mission Profile (Sheet 1 of 2)

SELF DEPLOYMENT MISSION PROFILE
ESSS/2-230 AND 2-450 GALLON TANK CONFIGURATION
STANDARD DAY 10 KT HEADWIND
HIRSS SUPPRESSED MODE
GROSS WEIGHT = 24,500 LB FUEL LOAD = 11,000 LB (JP4)
BLEED AIR OFF 60 LB WARM UP

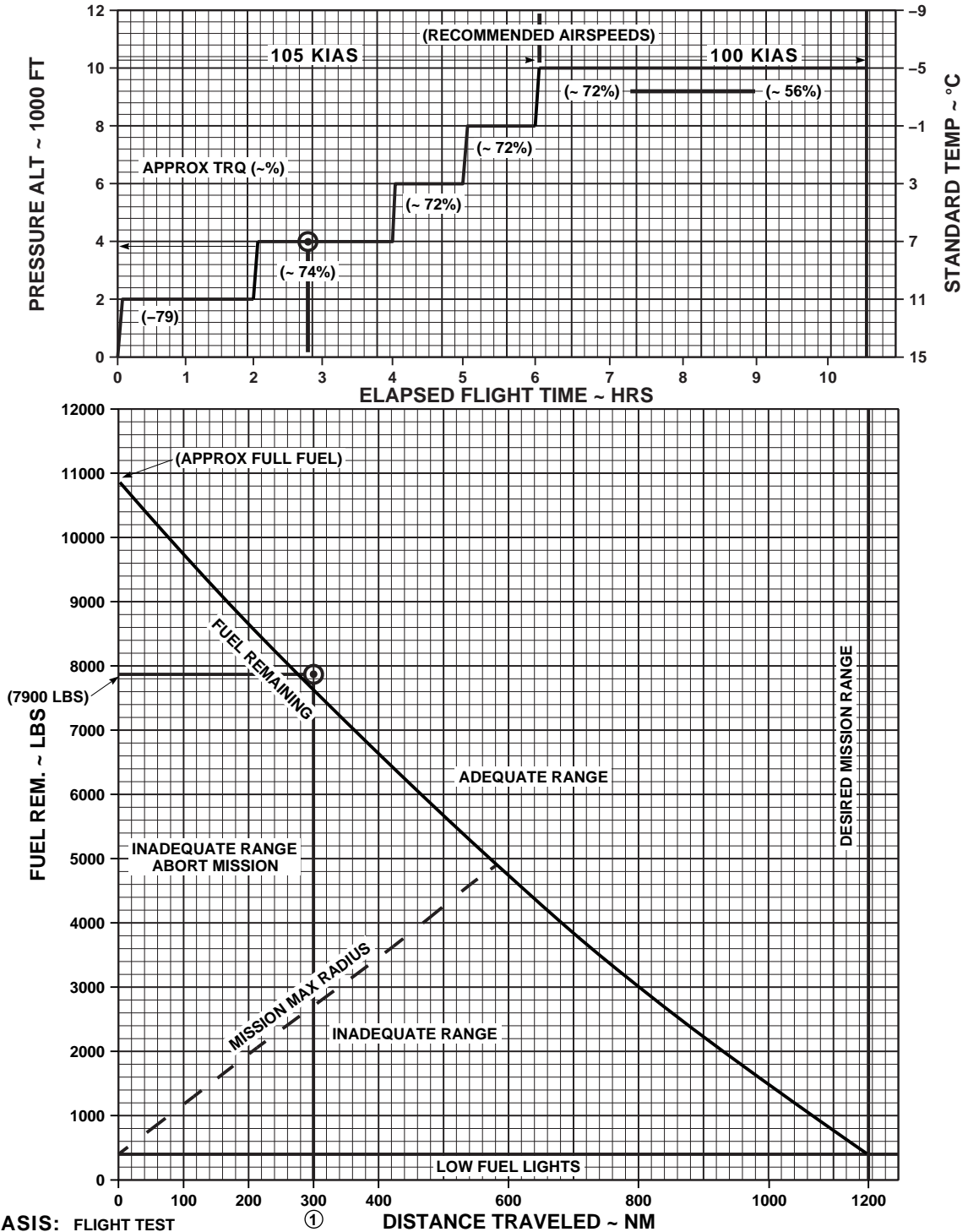

AA1030A
SA

Figure 7A-40. Self Deployment Mission Profile (Sheet 2 of 2)

ASSAULT MISSION PROFILE FOR MAX RANGE

ESSS/4-230 GALLON TANK CONFIGURATION

STANDARD DAY ZERO HEADWIND

HIRSS SUPPRESSED MODE

GROSS WEIGHT = 22000 LBF FUEL LOAD = 8280 LB (JP4)

BLEED AIR OFF

80 LB WARM UP

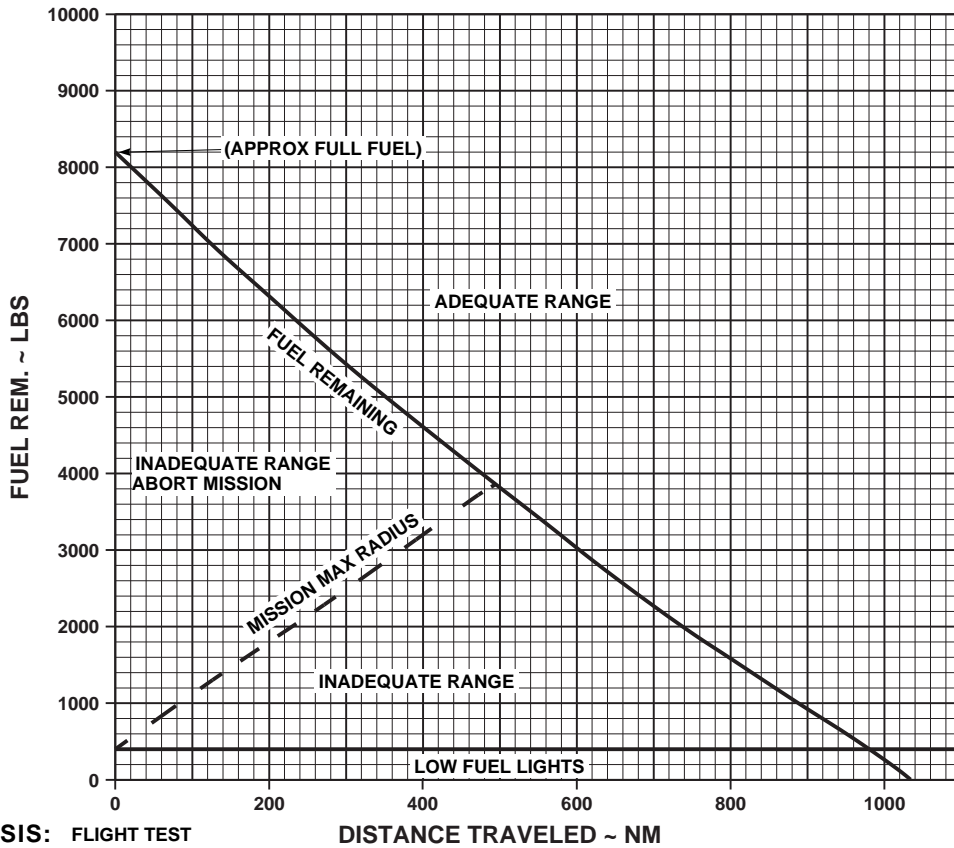
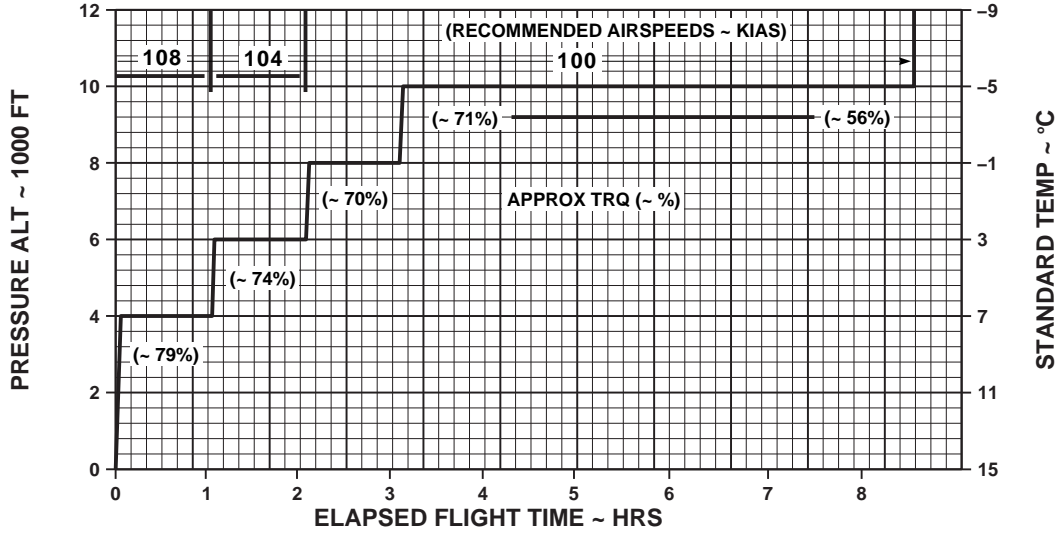

DATA BASIS: FLIGHT TEST

DISTANCE TRAVELED ~ NM

AA1031A
SA

Figure 7A-41. Assault Mission Profile (4 - 230 Gallon Tanks)

ASSAULT MISSION PROFILE FOR MAX RANGE
ESSS/2-230 GALLON TANK CONFIGURATION
STANDARD DAY ZERO HEADWIND
HIRSS SUPPRESSED MODE
GROSS WEIGHT = 22000 LB FUEL LOAD = 5280 LB (JP4)
BLEED AIR OFF 80 LB WARM UP

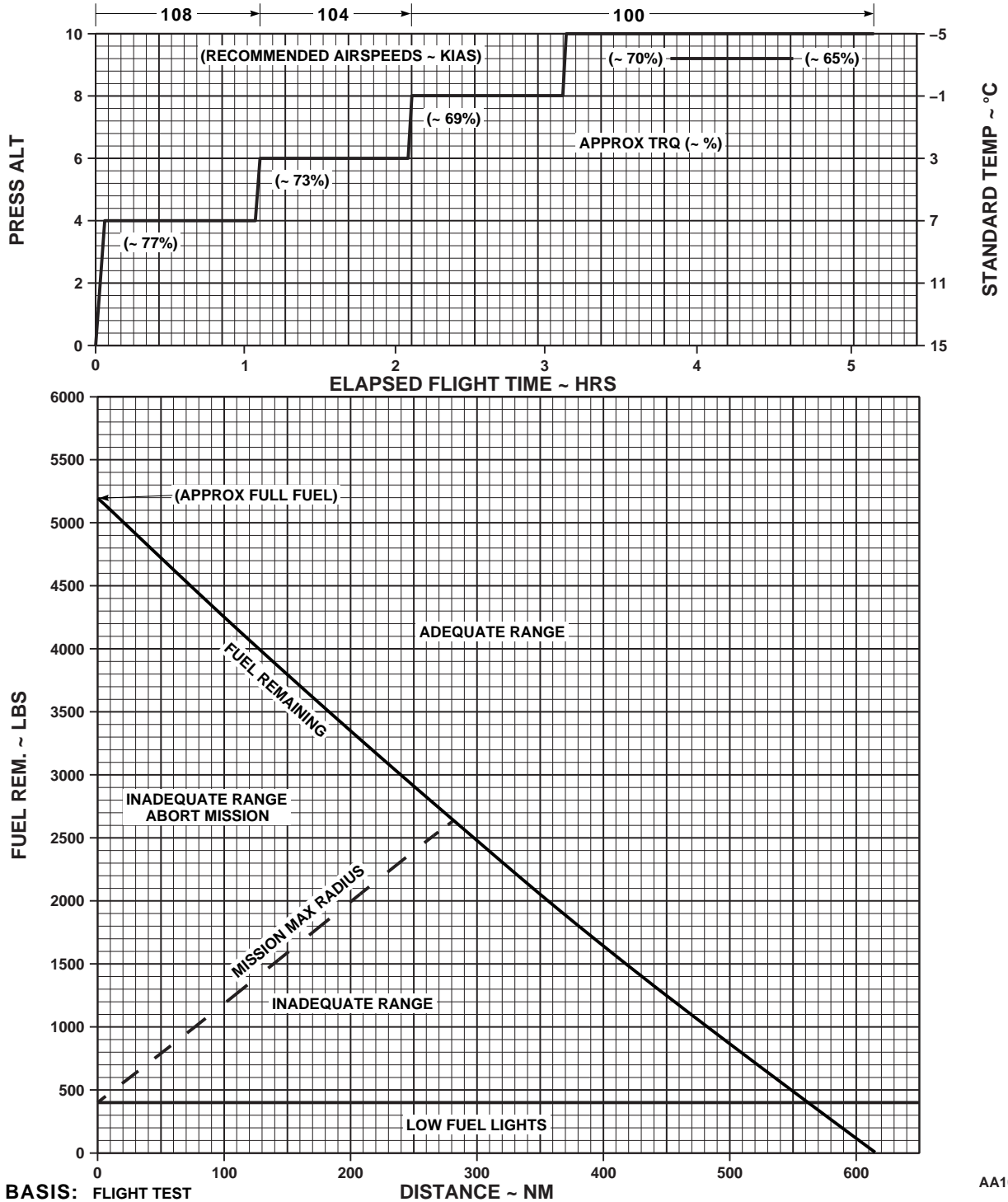

AA1032A
SA

Figure 7A-42. Assault Mission Profile (2 - 230 Gallon Tanks)

CHAPTER 8

NORMAL PROCEDURES

Section I MISSION PLANNING

8.1 MISSION PLANNING

Mission planning begins when the mission is assigned and extends to the preflight check of the helicopter. It includes, but is not limited to checks of operating limits and restrictions; weight, balance, and loading; performance; publications; flight plan; and crew and passenger briefings. The pilot in command shall ensure compliance with the contents of this manual that are applicable to the mission and all aviation support equipment required for the mission (e.g., helmets, gloves, survival vests, survival kits, etc).

8.2 EH-60A DATA. **EH**

AN/ALQ-151(V)2; mission operator duties, equipment checks, system initialization procedures, and self-test procedures are outlined in TM 32-5865-012-10.

8.3 AVIATION LIFE SUPPORT EQUIPMENT. (ALSE)

All aviation life support equipment required for mission; e.g., helmets, gloves, survival vests, survival kits, etc., shall be checked.

8.4 CREW DUTIES/RESPONSIBILITIES.

The minimum crew required to fly the helicopter is two pilots. Additional crewmembers, as required, may be added at the discretion of the commander. The manner in which each crewmember performs his related duties is the responsibility of the pilot in command.

a. The pilot in command is responsible for all aspects of mission planning, preflight, and operation of the helicopter. He will assign duties and functions to all other crewmembers as required. Prior to or during preflight, the pilot will brief the crew on items pertinent to the mission; e.g., performance data, monitoring of instruments, communications, emergency procedures, taxi, and load operations.

b. The pilot in command must be familiar with pilot duties and the duties of the other crew positions.

c. The crew chief will perform all duties as assigned by the pilot.

8.5 CREW BRIEFING.

A crew briefing shall be conducted to ensure a thorough understanding of individual and team responsibilities. The briefing should include, but not be limited to, pilots, crew chief, mission equipment operator, ground crew responsibilities, and the coordination necessary to complete the mission in the most efficient manner. A review of visual signals is desirable when ground guides do not have direct voice communications link with the crew.

8.6 PASSENGER BRIEFING.

The following guide may be used in accomplishing required passenger briefings. Items that do not pertain to a specific mission may be omitted.

- a. Crew introduction.
- b. Equipment.
 - (1) Personal, to include ID tags.
 - (2) Professional.
 - (3) Survival.
- c. Flight data.
 - (1) Route.
 - (2) Altitude.
 - (3) Time en route.
 - (4) Weather.
- d. Normal procedures.
 - (1) Entry and exit the helicopter.

- (2) Seating.
 - (3) Seat belts.
 - (4) Movement in helicopter.
 - (5) Internal communications.
 - (6) Security of equipment.
 - (7) Smoking.
 - (8) Oxygen.
 - (9) Refueling.
 - (10) Weapons.
 - (11) Protective masks.
 - (12) Parachutes.
 - (13) Hearing protection.
 - (14) Aviation life support equipment (ALSE).
- e. Emergency procedures.
- (1) Emergency exits.
 - (2) Emergency equipment.
 - (3) Emergency landing/ditching procedures.

Section II OPERATING PROCEDURES AND MANEUVERS

8.7 OPERATING PROCEDURES AND MANEUVERS.

This section deals with normal procedures and includes all steps necessary to ensure safe and efficient operation of the helicopter from the time a preflight begins until the flight is completed and the helicopter is parked and secured. Unique feel, characteristics, and reaction of the helicopter during various phases of operation and the techniques and procedures used for taxiing, takeoff, climb, etc., are described, including precautions to be observed. Your flying experience is recognized; therefore, basic flight principles are avoided. Only the duties of the minimum crew necessary for the actual operation of the helicopter are included. Additional crew duties are covered as necessary in Section I Mission Planning. Mission equipment checks are contained in Chapter 4 Mission Equipment. Procedures specifically related to instrument flight that are different from normal procedures are covered in this section, following normal procedures. Descriptions of functions, operations, and effects of controls are covered in Section IV Flight Characteristics, and are repeated in this section only when required for emphasis. Checks that must be performed under adverse environmental conditions, such as desert and cold-weather operations, supplement normal procedures checks in this section and are covered in Section V Adverse Environmental Conditions.

8.8 SYMBOLS DEFINITION.

Items which apply only to night or only to instrument flying shall have an N or an I, respectively, immediately preceding the check to which it is pertinent. The symbol O shall be used to indicate "if installed". Those duties which are the responsibility of the pilot not on the controls, will be indicated by a circle around the step number; i.e., ④. The symbol star★ indicates an operational check is required. Operational checks are contained in the performance section of the condensed checklist. The asterisk symbol * indicates that performance of step is mandatory for all thru-flights. The asterisk applies only to checks performed prior to takeoff. Placarded items such as switch and control labels appear in uppercase type.

8.9 CHECKLIST.

Normal procedures are given primarily in checklist form, and amplified as necessary in accompanying paragraph form, when a detailed description of a procedure or maneu-

ver is required. A condensed version of the amplified checklist, omitting all explanatory text, is contained in the operator's checklist. To provide for easier cross-referencing, the procedural steps in the checklist are numbered to coincide with the corresponding numbered steps in this manual.

8.10 PREFLIGHT CHECK.

The pilot's walkaround and interior checks are outlined in the following procedures. The preflight check is not intended to be a detailed mechanical inspection. The preflight order is a recommended sequence only. The expanded sub-steps do not need to be memorized or accomplished in order. The steps that are essential for safe helicopter operation are included. The preflight may be made as comprehensive as conditions warrant at the discretion of the pilot.

8.11 BEFORE EXTERIOR CHECK (FIGURE 8-1).

WARNING

Do not preflight until armament systems are safe, switches off, safety pins installed and locking levers in locked position.

1. Publications - Check; required forms and publications, and availability of operator's manual(s) (-10) and checklist (-CL).
- *2. Helicopter covers, locking devices, tiedowns, and grounding cables - Removed and secured.
- *3. Fuel - Check quantity as required.
4. Fuel sample - As required. Check for contamination before first flight of the day and after adequate settling time after cold refueling, or if fuel source is suspected contaminated.

8.12 EXTERIOR CHECK.

Exterior walkaround diagram is shown in Figure 8-1.

8.13 NOSE SECTION (AREA 1).



Do not deflect main rotor blade tips more than 6 inches below normal droop position when attaching tiedowns. Do not tie down below normal droop position.

- *1. Main rotor blades - Check.
- 2. Fuselage - Nose area, check as follows:
 - a. Windshield and wipers - Check.
 - O b. Blade deice OAT sensor, FAT indicator probe(s) - Check.
 - c. Avionics compartment - Check equipment as required; secure door.
 - d. Antennas - Check.
 - e. Landing and searchlights - Check.

8.14 COCKPIT - LEFT SIDE (AREA 2).

- 1. Cockpit area - Check as follows:
 - a. Cockpit door - Check.
 - b. Copilot seat, belts, and harness - Check.
 - c. FM and **EH** antennas - Check.
 - d. Landing gear support fairing and step - Check.
 - e. Position light - Check.
 - f. Main landing gear - Check.
 - O g. **ES** HSS, VSP, ejector rack locking levers locked, fairings, and external tanks - Check; refueling caps secure.
 - h. Gunner's window - Check.
 - i. Ambient sense port - Check.
- *2. Left engine oil level - Check.

*3. Check MLG drag beam for cracks.

8.15 CABIN TOP (AREA 3).

- 1. Cabin top - Check as follows:
 - a. Left engine - Check inlet.
 - b. Left pitot tube - Check.
 - c. Control access - Check flight controls, hydraulic reservoir, and filter indicators. Check tempilabels for safe indication and security. Check area.
 - d. Control access cover - Close and check secured.
 - e. Right pitot tube - Check.
 - f. Right engine - Check inlet.
 - O g. IRCM - Check.
- 2. APU - Check; oil level, use dipstick.
- O 3. APU IPS - Check.
- 4. Gust lock - Check.
- 5. Main transmission - Check; oil level.
- *6. Main rotor system - Check controls, dampers, head, and blades. BIM® indicators - Check for safe indication (yellow color).

8.16 INTERIOR CABIN (AREA 4).

- 1. Cabin - Check as follows:
 - a. Fire extinguishers - Check.
 - b. First aid kits - Check.
 - c. Pilot's and copilot's tilt-back release levers - Lock position.
 - d. Cabin interior - Check security of stowed equipment.
 - e. Cabin seats and belts - Check.
- 2. APU accumulator pressure gage - Check minimum 2,800 psi.

3. Transmission oil filter impending bypass indicator - Check.
4. Cargo hook:
 - a. General condition and security.
5. Survival gear and mission equipment - Check as required.
6. Electrical connections condition and security.

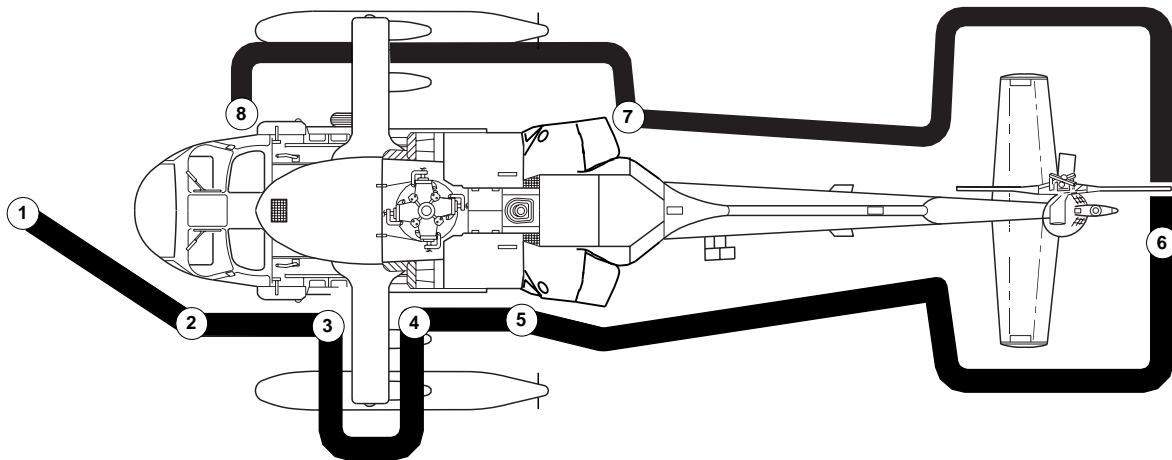

- | | | | |
|--------|---------------------|--------|-----------------------|
| AREA 1 | NOSE SECTION | AREA 5 | FUSELAGE - LEFT SIDE |
| AREA 2 | COCKPIT - LEFT SIDE | AREA 6 | TAIL PYLON |
| AREA 3 | CABIN TOP | AREA 7 | FUSELAGE - RIGHT SIDE |
| AREA 4 | INTERIOR CABIN | AREA 8 | COCKPIT - RIGHT SIDE |

AA0672A
SA

Figure 8-1. Exterior Check Diagram

8.17 FUSELAGE - LEFT SIDE (AREA 5).

1. Fuselage - Check as follows:
 - a. Cabin door - Check.
 - O*b. **VOL** Armament system - Check.
 - c. Fuel tank filler ports - Check; caps secure, doors secured.
 - d. External pneumatic inlet port - Door secured.
 - e. Engine exhaust - Check.
 - O f. APU IPS exhaust - Check.
 - g. APU exhaust - Check.
 - O h. Chaff and flare dispensers - Check; number and programmer settings.
 - i. Lower anticollision light - Check.
 - j. Antennas - Check.

k. Tail landing gear - Check.

*2. Intermediate gear box - Check; oil level.

8.18 TAIL PYLON (AREA 6).

1. Tail pylon - Check as follows:
 - a. Tail pylon - Check.
 - b. Stabilator - Check.
 - O c. Radar detector and **EH**antennas - Check.
 - d. Position light - Check.
 - e. Upper anticollision light - Check.
- *2. Tail rotor - Check.
- *3. Tail rotor gear box - Check; oil level.

8.19 FUSELAGE - RIGHT SIDE (AREA 7).

1. Fuselage - Check as follows:
 - a. Antennas - Check.

- b. **EH**Aft avionics compartment circuit breakers and ECS fluid level - Check.
- c. Fire bottles thermal plug - Check.
- d. Engine exhaust - Check.
- e. Fuel tank gravity filler port - Check cap secure; door secured.
- O*f. **VOL** Armament system - Check.
- g. Cabin door - Check.

8.20 COCKPIT - RIGHT SIDE (AREA 8).

- *1. Right engine oil level - Check.
- 2. Cockpit area - Check as follows:
 - O a. Ice detector - Check.
 - b. Ambient sense port - Check.
 - O c. **ES** HSS, VSP, ejector rack locking levers locked, fairings, and external tanks - Check; refueling caps secure.
 - d. Gunner's window - Check.
 - e. External electrical power receptacle - Door secured.
 - f. Main landing gear - Check.
 - g. Position light - Check.
 - h. Landing gear support fairing and step - Check.
 - i. FM and **EH** antennas - Check.
 - j. Cockpit door - Check.
 - k. Pilot seat, belt, and harness - Check.
 - l. Set switch on dimmer control box as desired. **NORM** for IR dimming.
- *3. Check MLG drag beam for cracks.
- ★*4. Crew and passenger briefing - Complete as required.

8.21 BEFORE STARTING ENGINES.

NOTE

Before engine operation can be performed with the gust locks engaged, all main rotor tie downs shall be removed.

- *1. Copilot's collective - Extended and locked.
- 2. Shoulder harness locks - Check.
- 3. **PARKING BRAKE** - Release, then set.
- ★4. Circuit breakers and switches - Set as follows:
 - a. Circuit breakers - In.
 - b. Avionics - Off, frequencies set.
 - c. **BLADE DEICE POWER** switch - **OFF**.
 - *d. Radar altimeter - Set. **EH** Left **LO** bug 200 feet.
 - e. Clocks - Set and running.
 - f. **BACKUP HYD PUMP** - **AUTO**.
 - *g. **ANTICOLLISION/POSITION LIGHTS** - As required.
 - *h. **EH**Q/F PWR switch - **OFF**.
 - O*i. **EH**ECS panel switches - **OFF**.
 - j. **CARGO HOOK EMERG REL** switch - **OPEN**, **ARMING** switch - **SAFE**.
 - k. **APU CONTR** switch - **OFF**; **APU** T-handle - In.
 - l. **GENERATORS NO. 1** and **NO. 2** switches - Check **ON**.
 - m. Ground power unit - Connected if required.
 - *n. **AIR SOURCE HEAT/START** switch - **APU** (**OFF** for external air source).
 - o. **EMER OFF** T-handles - Full forward.
 - *p. **BATT** switch - **ON**.

8.22 COCKPIT EQUIPMENT CHECKS.

- *1. **FUEL PUMP** switch - **APU BOOST**.
- *2. **APU CONTR** switch - **ON**.

NOTE

If the APU does not start and the **APU ACCUM LOW** advisory light is not on with the **APU CONTR** switch **ON**, the manual override lever on the accumulator manifold should be pulled to attempt another start, and held until the APU has reached self-sustaining speed.

If APU fails, note and analyze BITE indications before cycling **BATT** switch or before attempting another APU start.



Stabilator will move to full trailing edge down position upon application of AC power. Assure stabilator area is clear prior to energizing stabilator system.

- *3. **APU** generator switch - **ON**.
- *4. **EXT PWR** switch - **OFF** and cable disconnected.
- O★5. **ERFS** **AUXILIARY FUEL MANAGEMENT** control panel - **TEST**.
- O*6. **ERFS** **AUXILIARY FUEL MANAGEMENT** control panel - Set fuel as required.
- *7. **EH** **IINS SYSTEMS SELECT** switches - **DG** and **VG**.
- ★*8. **EH** **IINS** - Align.
- 9. Caution/advisory/warning panels - Check as required.

NOTE

Pulsating of any caution/advisory lights in unison with the **LOW ROTOR RPM** warning lights may occur in the **DIM** mode.

The switch legend on the **VSI/HSI** and **CIS** mode select panels may change when the

caution/advisory panel **BRT/DIM-TEST** switch is set to **TEST**. (This can also occur in flight). The original indications may be restored by pressing the applicable switches.

- a. Caution/advisory panel **BRT/DIM-TEST** switch - **TEST**. Caution/advisory/warning, **CIS/MODE SEL**, and **VSI** advisory lights on. **#1** and **#2 FUEL LOW** caution lights flashing. **AFCS FAILURE ADVISORY** lights will illuminate. **EH** **SYSTEMS SELECT** switches will illuminate. **EH** **ASE** advisory light - Press to test.
- N b. **INSTR LT PILOT FLT** control - **ON**.
- N c. Caution/advisory **BRT/DIM-TEST** switch - **BRT/DIM** momentarily and then to **TEST**.
- N d. All caution/advisory/warning panels **CIS/MODE SEL** and **VSI** advisory lights on at decreased intensity. **AFCS FAILURE ADVISORY** lights will not dim.



If DEC signal validation codes are displayed on the % TRQ indicator, do not fly the helicopter.

- 10. **701C** **DEC** engine fault indicator codes - Check for signal validation as required.
- N 11. Interior/exterior lighting - Set.
- O★12. Mission equipment - Check.
- ★*13. Cold weather control exercise - Check if temperature is below -17°C (1°F).
- *14. **AFCS FAILURE ADVISORY** lights - If on, **POWER ON RESET**.
- *15. **SAS1** off, **SAS2**, **TRIM**, **FPS**, and **BOOST** switches - Push **ON**.
- ★16. Flight controls - Check first aircraft flight of day as follows:
 - a. Collective - Midposition, pedals centered, friction off.

- b. **BOOST** switch - Press off. There will be a slight increase in collective and pedal forces. **BOOST SERVO OFF** and **MASTER CAUTION** lights should be on.
- c. Right **SVO OFF** switch - **1ST STG.** No allowable cyclic stick jump. **#1 PRI SERVO PRESS** and **MASTER CAUTION** lights should be on.
- d. Move cyclic and pedals slowly through full range. There should be no binds or restrictions. Move collective full up to full down in about 1 to 2 seconds. Check **#2 PRI SERVO PRESS** caution light does not illuminate during movement of collective.
- e. Right **SVO OFF** switch - **2ND STG.** No allowable cyclic stick jump. **#2 PRI SERVO PRESS** and **MASTER CAUTION** lights should be on.
- f. Repeat step d. above. Check **#1 PRI SERVO PRESS** caution light does not illuminate during movement of collective.



If #1 PRI SERVO PRESS or #2 PRI SERVO PRESS caution light illuminates during collective movement, a servo bypass valve may be jammed. If this situation occurs, do not fly the helicopter.

- g. **SVO OFF** switch - Center.

NOTE

During steps h. and i., check for not more than 1.5 inches of freeplay in control.

- h. Collective - Move through full range in no less than 5 seconds. There should be no binding.
- i. Pedals - Move both pedals through the full range in no less than 5 seconds. There should be no binding.
- j. **TAIL SERVO** switch - **BACKUP.** **#1 TAIL RTR SERVO** caution light, both **MASTER CAUTION** lights, and **#2**

TAIL RTR SERVO ON advisory light illuminate. Move pedals through full range in no less than 5 seconds. There should be no binding.

- k. **TAIL SERVO** switch - **NORMAL.** Caution and advisory lights out.
- l. **BOOST** switch - **ON.** **BOOST SERVO OFF** caution light should be off.

★17. Stabilator - Check.



If any part of stabilator check fails, do not fly helicopter.

NOTE

For the purpose of this check, the right **STAB POS** indicator shall be used. The left **STAB POS** indicator may vary from right indicator as much as $\pm 2^\circ$ throughout the check.

- a. **STAB POS** indicator should be between 34° and 42° **DN.**
- b. **TEST** button - Press and hold. Check **STAB POS** indicator moves up 5° to 12° . **MASTER CAUTION** and **STABILATOR** caution lights on; stabilator audio heard.
- c. **AUTO CONTROL RESET** switch - Press **ON.** Note that the **STABILATOR** caution light and audio are off, and **STAB POS** indicator moves to 34° to 42° down.
- d. Either cyclic mounted stabilator slew-up switch - Press and hold until **STAB POS** indicator moves approximately 15° trailing edge up, release, stabilator should stop. **STABILATOR** and **MASTER CAUTION** lights on and beeping audible warning in pilot's and copilot's headsets. **MASTER CAUTION** - Press to reset audio tone.
- e. Other cyclic mounted stabilator slew-up switch - Press and hold until **STAB POS**

indicator moves approximately 15° trailing edge up, release, stabilator should stop.

- f. **MAN SLEW** switch - **UP** and hold until stabilator stops. **STAB POS** indicator should be 6° to 10° up.

- g. **MAN SLEW** switch - **DN** and hold until **STAB POS** indicator reads 0°.

h. **AUTO CONTROL RESET** switch - Press **ON**. **STAB POS** indicator should move 34° to 42° **DN**. **STABILATOR** caution light off.

*18. Avionics - On.

*18.1. Doppler/GPS - Program.

*18.2. Doppler/GPS mode select switch - **OFF**.

*19. **COMPASS** switch - **SLAVED**. Set as required.

20. Barometric altimeters - Set.

*21. Cyclic and pedals centered. Collective raise no more than 1 inch (to prevent droop stop pounding) and friction.

22. **BACKUP HYD PUMP** switch - **OFF**.

O★23. Blade deice system - Test as required.



Do not perform blade deice test when blade erosion kit is installed.

To prevent overheating of droop stops, blade deice test shall not be done more than one time within a 30-minute period when rotor head is not turning.

a. Ice rate meter **PRESS TO TEST** button - Press and release.

b. Ice rate meter indicator - Moves to half scale (1.0) holds about 50 seconds; then falls to 0 or below. **ICE DETECTED** and **MASTER CAUTION** lights on after 15 to 20 seconds into the test, and **FAIL** flag should not be visible in flag window. Ice rate meter should move to zero within 75 seconds after pressing **PRESS TO TEST** button.

NOTE

PWR MAIN RTR and **PWR TAIL RTR** monitor lights may flicker during tests in steps e. through q.

c. **BLADE DE-ICE TEST** panel select switch - **NORM**.

c.1 **PWR MAIN RTR** and **TAIL RTR** monitor lights - Press to test.

d. **BLADE DEICE POWER** switch - **TEST**.

e. **PWR MAIN RTR** and **TAIL RTR** monitor lights - Check. **MAIN RTR** monitor light may go on for 2 to 4 seconds. If either light remains on for 10 seconds or more:

(1) **BLADE DEICE POWER** switch - **OFF**. If either light is still on:

(2) **APU** generator switch and/or **EXT PWR** switch - **OFF**.

f. **TEST IN PROGRESS** light - Check. The light should be on for 105 to 135 seconds. No other blade deice system lights should be on. **PWR MAIN RTR** and **TAIL RTR** monitor lights may go on momentarily near end of test. The **TEST IN PROGRESS** light should then go off.



Droop stop hinge pins and cams may become very hot during test. Use care when touching those components.

g. Crewman touch each droop stop cam - Cams should be warm to touch.

h. **BLADE DEICE POWER** switch - **OFF**.

i. **BLADE DE-ICE TEST** panel select switch - **SYNC 1**.

j. **BLADE DEICE POWER** switch - **TEST**. **MR DE-ICE FAIL** and **MASTER CAUTION** lights on.

k. **BLADE DEICE POWER** switch - **OFF**. **MR DE-ICE FAIL** and **MASTER CAUTION** lights off.

l. **BLADE DE-ICE TEST** panel select switch - **SYNC 2**.

- m. **BLADE DEICE POWER** switch - **TEST**. **MR DE-ICE FAIL** and **MASTER CAUTION** lights on.
- n. **BLADE DEICE POWER** switch - **OFF**. **MR DE-ICE FAIL** and **MASTER CAUTION** lights off.
- o. **BLADE DE-ICE TEST** panel select switch - **OAT**.
- p. **BLADE DEICE POWER** switch - **TEST**. **MR DE-ICE FAIL**, **TR DE-ICE FAIL**, and **MASTER CAUTION** lights on.
- q. **BLADE DEICE POWER** switch - **OFF**. **MR DE-ICE FAIL**, **TR DE-ICE FAIL**, and **MASTER CAUTION** lights off.
- r. **BLADE DE-ICE TEST** panel select switch - **NORM**.

24. Avionics - Check as required.

- O ★ *25. **AFMS** Auxiliary Fuel Management Panel - **TEST**, set as required.

8.23 STARTING ENGINES.

- *1. **ENG FUEL SYS** selector(s) - As required. **XFD** for first start of day.
- *2. Deleted.
- *3. **ENGINE IGNITION** switch - **ON**.
- *4. **GUST LOCK** caution light - Off.
- *5. Fire guard - Posted if available.
- *6. Rotor blades - Check clear.

- ★* (7) Engine(s) - Start as follows:



If start is attempted with **ENGINE IGNITION** switch **OFF**, do not place switch **ON**. Complete **EMER ENG SHUTDOWN** procedure.

- a. If any of these indications occur, perform **EMER ENG SHUTDOWN** as required.

- (1) No **TGT TEMP** increase (light off) within 45 seconds.
- (2) No **ENG OIL PRESS** within 45 seconds.
- (3) No **% RPM 1** or **2** within 45 seconds.
- (4) **ENGINE STARTER** caution light goes off before reaching **52% Ng SPEED**.
- (5) **TGT TEMP** reaches **700** 850°C or **701C** 851°C before idle is attained (Ng 63%).



To avoid damage to the engine start switch actuators, do not move the **ENG POWER CONT** lever from **IDLE** to **OFF** while pressing the starter button.

During engine start and runup ensure that cyclic is kept in neutral, collective no more than one inch above full down, and pedals centered until **% RPM R** reaches **50% minimum** to prevent damage to anti-flap bracket bushings.

- b. Starter button(s) - Press until **Ng SPEED** increases; release.

NOTE

If an **ENGINE STARTER** caution light goes off when the starter button is released, and the **ENG POWER CONT** lever is **OFF**, the start attempt may be continued by pressing and holding the starter button until **52% to 65% Ng SPEED** is reached; then release button.

- c. **TGT TEMP** - Check below **700** 150°C or **701C** 80°C before advancing **ENG POWER CONT** levers.
- d. **ENG POWER CONT** lever(s) - **IDLE**. Start clock.
- e. System indications - Check.

f. **ENGINE STARTER** caution light(s).
Check, off at 52% to 65% **Ng SPEED**. If
ENGINE STARTER caution light re-
mains on after 65% Ng:

(1) **ENG POWER CONT** lever - Pull
out.

If caution light remains on:

- (2) **APU - OFF** or engine air source remove as required.

* (8) If single-engine start was made, repeat step 7 for other engine.

* (9) Systems - Check.

- a. **Ng SPEED** - 63% or greater and within 3% of each other.
- b. **% RPM** - Check that **% RPM 1** or **2** is not in the range of 20% to 40% and 60% to 90%. Advance **ENG POWER CONT** lever(s) as required.
- c. **XMSN PRESS** - Check.
- d. **ENG OIL PRESS** - Check.
- e. **#1** and **#2 HYD PUMP** caution lights - Check off.

* (10) **BACKUP HYD PUMP** switch - **AUTO**.

★ (11) Hydraulic leak test system - Check as follows:

NOTE

EH It is normal for the IINS CDU screen to blank momentarily during the hydraulic leak test system check.

When performing the **HYD LEAK TEST**, all leak detection/isolation system components are checked electrically. Manually holding the **HYD LEAK TEST** switch in the test position does not allow the leak detection/isolation system to be checked automatically. It manually holds the circuits open. The switch must be placed in the **TEST** position and released.

- a. **HYD LEAK TEST** switch - **TEST**. **#1 TAIL RTR SERVO, BOOST SERVO OFF, SAS OFF, #1 and #2 RSVR LOW, BACK-UP RSVR LOW, and MASTER CAUTION** lights and **#2 TAIL RTR SERVO ON** and **BACK-UP PUMP ON** advisory lights on. During this check, it is normal for the collective and pedals to move slightly.

- b. **HYD LEAK TEST** switch - **RESET**. The lights in a. should go off.

NOTE

If the backup pump is still running following the hydraulic leak test, cycle the **BACKUP HYD PUMP** switch to **OFF** then back to **AUTO**.

★ (12) Tail rotor servo transfer - Check.

- a. **BACKUP HYD PUMP** switch - **AUTO** with backup pump not running.

NOTE

Failure of the **BACK-UP PUMP ON** advisory light or the **#2 TAIL RTR SERVO ON** advisory light indicates a failure in the leak detection/isolation system.

- b. **TAIL SERVO** switch - **BACKUP**. **#1 TAIL RTR SERVO** caution light on and **#2 TAIL RTR SERVO ON** and **BACK-UP PUMP ON** advisory lights on within 3 to 5 seconds.
- c. **TAIL SERVO** switch - **NORMAL**. **#1 TAIL RTR SERVO** caution light and **#2 TAIL RTR SERVO ON** advisory light off. **BACK-UP PUMP ON** advisory light remains on for approximately 90 seconds.

O (13) **AUX CABIN HEATER** switch - As desired.

NOTE

Cabin temperature must be below 29°C (84°F) for heat to go on, and above 10°C (50°F) for the heater to shut off.

*14. Engine warmup - Check if temperature is below -17°C (1°F).

- a. At temperatures between -17°C (1°F) and -43°C (-45°F), warm engines at **IDLE** for 3 minutes.
- b. At temperatures between -43°C (-45°F) and -54°C (-65°F), warm engines at **IDLE** for 5 minutes.

8.24 ENGINE RUNUP.

*1. Flight controls - Hold.

WARNING

Restrict the rate of ENG POWER CONT lever's movement, when the tailwheel lockpin is not engaged. Rapid application of ENG POWER CONT levers can result in turning the helicopter, causing personnel injury or loss of life.

- * ② ENG POWER CONT lever(s) - FLY.
- *3. Droop stops - Check out 70% to 75% RPM R.
- * ④ #1 and #2 GEN caution lights - Off.

CAUTION

EH During operation of the air conditioner system, the right cabin door should remain closed. If opening is required, the right cabin door should not remain open for more than 1 minute.

- *5. **EH**ECS panel switches - As desired.

NOTE

ECS heater will operate with either backup pump or windshield anti-ice operating, but not with both at the same time.

- O★ ⑥ DEICE EOT - Check as required.

CAUTION

In ambient temperatures above 21°C (70°F), operate rotor at 100% RPM R for 5 minutes before doing the deice EOT check, to prevent blade overheating. Do not do the deice EOT check if OAT is above 38°C (100°F).

- a. BLADE DE-ICE TEST select switch - EOT.
- b. BLADE DEICE MODE select switch - MANUAL M.

- c. BLADE DEICE POWER switch - ON.
- d. TR DE-ICE FAIL caution and MASTER CAUTION lights on after 15 to 30 seconds, and MR DE-ICE FAIL caution light on after 50 to 70 seconds.
- e. BLADE DEICE POWER switch - OFF. TR DE-ICE FAIL , MR DE-ICE FAIL , and MASTER CAUTION lights off.
- f. BLADE DE-ICE TEST select switch - NORM.

NOTE

If helicopter engine was started using external air source and/or external ac power, the APU must be started to do APU generator backup check.

- g. GENERATORS NO. 1 or NO. 2 switch - OFF. Applicable GEN and MASTER CAUTION lights on.
- h. BLADE DEICE POWER switch - ON. Wait 30 seconds, no deice lights on.
- i. GENERATORS switch(es) - ON. Applicable GEN caution light(s) off.
- j. BLADE DEICE POWER switch - OFF.
- k. BLADE DEICE MODE select switch - AUTO.

- *7. % TRQ 1 and 2 - Matched within 5%.

- * ⑧ **EH**Q/F PWR switch - As desired.
- * ⑨ FUEL PUMP switch - OFF.
- * ⑩ APU CONTR switch - OFF.
- * ⑪ AIR SOURCE HEAT/START switch - As required.
- * ⑫ ENG FUEL SYS selectors - As required.
- * ⑬ SAS 1 - ON.

- *13.1. Doppler/GPS mode select switch - As desired.

- *14. Collective friction - As required.

NOTE

A slight amount of collective friction (approximately 3 pounds) should be used to prevent pilot induced collective oscillations.

- N O*15. HUD - Adjust brightness, mode, barometric altitude, pitch, and roll as necessary.
- O * ①6. **EH IINS NAVRDY** light flashing - CDU mode select switch to **NAV**.
- O * ①7. **EH IINS SYSTEMS SELECT** switches - **IINS**.



Engine anti-ice bleed and start valve malfunction can cause engine flameout.

- ①8. Engine Health Indicator Test (HIT)/Anti-Icing Check - Accomplish. Refer to ENGINE HEALTH INDICATOR TEST/ANTI-ICE CHECK IN HELICOPTER LOG BOOK. HIT/ANTI-ICE checks while operating in adverse conditions (e.g., dust, desert, coastal beach area, dry river beds) may be deferred (maximum of 5 flight hours) until a suitable location is reached.
- *19. **FUEL BOOST PUMP CONTROL** switches - **ON** (for all fuel types). Indicator lights check - On.
- O ★ ②0. **ERFS AFMS** External extended range fuel transfer - Check.

8.25 BEFORE TAXI.



ESWhen on the ground, the ejector rack lock lever should be turned inward to allow the pilot visual confirmation from the cockpit. Prior to flight, the ejector rack lock lever must be in the unlock (vertical) position to allow emergency jettisoning of the tanks in flight.

- O*1. **ES**Ejector rack lock levers unlocked.

- O*2. **VOL** Volcano jettison safety pins - Remove and red arming levers to arm.
- O*3. Chaff, flare electronic module(s) safety pin(s) - Remove.
- *4. Chocks - Removed.
- *5. Doors - Secure.
- *6. **PARKING BRAKE** - Release.
- * ⑦. **TAIL WHEEL** switch - As required.
- 8. Wheel brakes - Check as required.

8.26 GROUND TAXI.



When performing these maneuvers, cyclic inputs should be minimized to prevent droop-stop pounding.

Landing and searchlight have less than one foot ground clearance when extended. Use caution when taxiing over rough terrain when landing light and/or searchlight are extended.

Increase collective and place cyclic forward of neutral to start forward movement. Minimize forward cyclic movement to prevent droop stop pounding. Reduce collective to minimum required to maintain forward movement. Soft or rough terrain may require additional collective pitch. The use of excessive collective pitch during taxi, especially at light gross weights, can cause the tailwheel to bounce. Regulate taxi speed with cyclic and collective and control heading with pedals. Use brakes as required.

8.27 HOVER CHECK.

- ①. Systems - Check caution/advisory panel, CDU and PDU(s) for normal indication.
- ②. Flight instruments - Check as required.
- ③. Power - Check. The power check is done by comparing the indicated torque required to hover with the predicted values from performance charts.

8.28 BEFORE TAKEOFF.



Pitot heat and anti-ice shall be on during operations in visible moisture with ambient temperature of 4°C (39°F) and below. Failure to turn on pitot heat in icing conditions can cause the stabilator to program trailing edge down during flight. If this occurs, manually slew the stabilator to zero degrees.

- * ① ENG POWER CONT levers - FLY.
- * ② Systems - Check.
- * ③ Avionics - As required.
- * ④ Crew, passengers, and mission equipment - Check.

8.29 TAKEOFF.



If the stabilator has not begun trailing edge up movement by 30 to 50 KIAS, abort the takeoff.

Refer to the height-velocity diagram, Figures 9-2 and 9-3, for avoid areas. Since suitable landing areas are often not available, operating outside avoid areas during takeoff and climb will provide the highest margin of safety.

8.30 AFTER TAKEOFF.



ERFS AFMS Fuel transfer sequence must be carefully planned and executed in order to maintain CG within limits.

- O★ ① **ERFS AFMS** Extended range fuel system transfer - As required.
- ② **EHASE** - As required.

- O★ ③ **VOL** Mine launch, post mine launch - As required.

8.31 BEFORE LANDING.

- ① **TAIL WHEEL** switch - As required.
- ② **PARKING BRAKE** - As required.
- ③ Crew, passengers, and mission equipment - Check.
 - a. **EHASE** check - As required.
 - O b. **EH ECM ANTENNA** switch - **RETRACT**. Check **ANTENNA RETRACTED** advisory light - On. ECM operator report antenna deployed light - Off.
 - O c. **EH IINS TACAN** - **OFF**.

8.32 LANDING.



During roll-on landing aerodynamic braking with aft cyclic is permitted with the tail wheel contacting the ground. Once the main wheels touchdown, the cyclic must be centered prior to reducing collective. Excessive aft cyclic may cause droop stop pounding and contact between main rotor blades and other portions of the aircraft. Aerodynamic braking is prohibited once the main landing gear touches down. Use brakes to stop the aircraft.

NOTE

Because of the flat profile of the main transmission, pitching the helicopter nose up as in hover, may cause a transient drop in indicated main transmission oil pressure, depending on degree of nose-up attitude.

- a. Roll-on landing. A roll-on landing may be used when the helicopter will not sustain a hover, to avoid hovering in snow or dust, if tail rotor control is lost, or when operating with one heavy external tank.



EH When landing the EH-60A in a nose downslope configuration, exercise extreme caution to prevent the main rotor blades from contacting the aft DF antennas. When the main wheels contact the ground, center the cyclic prior to reducing collective. The cyclic should be centered before the collective is placed in full down to prevent possible rotor/airframe contact. If droop stop contact is felt prior to the main wheels touching the ground, abort landing attempt.

- b. Slope landing. The tailwheel should be locked and the parking brake should be set. For slope landings and all ground operations, avoid using combinations of excessive cyclic and low collective settings. Where minimum collective is used, maintain cyclic near neutral position and avoid abrupt cyclic inputs. During nose-down slope landings, low-frequency oscillations may be eliminated by moving cyclic toward neutral and lowering collective.

8.33 AFTER LANDING CHECK.

- ① **TAIL WHEEL** switch - As required.
- ② Exterior lights - As required.
- ③ Avionics/mission equipment - As required.

8.34 PARKING AND SHUTDOWN.

- ① **TAIL WHEEL** switch - As required.
 - ② **PARKING BRAKE** - Set.
- 2.1. **FUEL BOOST PUMP CONTROL** switches - **OFF**.
3. Landing gear - Chocked.
- O 4. **AUXILIARY FUEL MANAGEMENT** control panel **ERFS** **FUEL XFR MODE**

switch - **OFF**. **AFMS** **XFER MODE** switch - **OFF**.

- O 5. **ERFS** **AFMS** **AUXILIARY FUEL MANAGEMENT** panel **PRESS** switch(es) - Off.
- O 6. **VOL** Volcano red arming levers - **SAFE** and jettison safety pins install.
- O 7. **ES** Ejector rack locking levers - Locked.
- O 8. Chaff, flare electronic module safety pin(s) - Install.
- ⑨ **EH** **IINS SYSTEMS SELECT** switches - **DG/VG**.
- O ⑩ **EH** **IINS** - **OFF**.
- O ⑪ **EH** **ECS** panel switches - **OFF**.
- ⑫ **SAS 1** - Off.
- 12.1 **DPLR GPS MODE SEL** switch - Off.
- ⑬ **DEICE, PITOT, ANTI-ICE, HEATER** and **EH** **Q/F PWR** switches - **OFF**.
- ⑭ **AIR SOURCE HEAT/START** switch - **APU**.
- ⑮ **FUEL PUMP** switch - **APU BOOST**.
- ⑯ **APU CONTR** switch - **ON**. The **APU ON, BACK-UP PUMP ON,** and **APU ACCUM LOW** advisory lights - On.

NOTE

If external electrical power is required for shutdown, it shall be connected and **EXT PWR** switch placed to **RESET** ; then **ON**. If external ac power is not available, complete normal shutdown on right engine before continuing.

17. Collective raise no more than 1 inch.

18. Flight controls - Hold.



During shutdown ensure that cyclic is kept in neutral or displaced slightly into prevailing wind, collective no more than one inch above full down and pedals centered.

Restrict the rate of ENG POWER CONT lever movement, when the tailwheel lockpin is not engaged. Abrupt application of ENG POWER CONT lever can result in turning the helicopter.

⑲ ENG POWER CONT levers - **IDLE**.

⑳ ENGINE IGNITION switch - **OFF**.

21. Cyclic - As required to prevent anti-flap pounding.

22. Droop stops - Verify in, about 50% **RPM R**. If one or more droop stops do not go in during rotor shutdown, shut down an engine to lower rotor idling RPM in an attempt to seat the droop stops. If droops still do not go in, accelerate rotor to above 75% **RPM R**. Repeat rotor shutdown procedures, slightly displacing cyclic in an attempt to dislodge jammed droop stop. If droop stops still do not go in, make certain that rotor disc area is clear of personnel and proceed with normal shutdown procedures while keeping cyclic in neutral position.



To prevent damage to anti-flap stops, do not increase collective pitch at any time during rotor coast-down.

㉓ BACKUP HYD PUMP switch - **OFF**.

24. Stabilator - Slew to 0° after last flight of the day.

㉕ BACK-UP PUMP ON advisory light - Check off.



Before moving ENG POWER CONT lever OFF, engine must be cooled for 2 minutes at an Ng SPEED of 90% or less. If an engine is shut down from a high power setting (above 90%) without being cooled for 2 minutes, and it is necessary to restart the engine, the restart should be done within 5 minutes after shutdown. If the restart can not be done within 5 minutes, the engine should be allowed to cool for 4 hours before attempting an engine restart.

㉖ ENG POWER CONT levers - **OFF** after 2 minutes at Ng SPEED of 90% or less.

㉗ ENG FUEL SYS selectors - **OFF**.

㉘ TGT TEMP - Monitor. If TGT TEMP rises above 538°C:

a. Start button - Press.

b. ENG POWER CONT lever(s) - Pull after TGT TEMP is below 538°C.

O ㉙ AUX CABIN HEATER switch - **OFF**.

30. 701C DEC torque indicator fault code - Check.

31. Avionics - Off.

32. Deleted.

O33. HUD ADJ/ON/OFF switch - **OFF**.

34. Overhead switches - As required:

a. ANTICOLLISION/POSITION LIGHTS.

b. Left panel light controls.

c. WINDSHIELD WIPER.

d. VENT BLOWER.

e. Right panel light controls.

- 35. **APU** generator switch - **OFF**.
- 36. **FUEL PUMP** switch - **OFF**.
- 37. **APU CONTR** switch - **OFF**.
- 38. **BATT** switch - **OFF**.

8.35. BEFORE LEAVING HELICOPTER.

- 1. Walkaround - Complete, checking for damage, fluid leaks and levels.
- 2. Mission equipment - Secure.
- 3. Complete log book forms.
- 4. Secure helicopter - As required.

Section III INSTRUMENT FLIGHT

8.36 INSTRUMENT FLIGHT.

Refer to FM 1-240 for instrument flying and navigation techniques.

Section IV FLIGHT CHARACTERISTICS

8.37 GENERAL.

a. Refer to FM 1-203 Fundamentals of Flight for explanation of aerodynamic flight characteristics.

b. The safe maximum operating airspeed range is described in Chapter 5. While hovering in high wind, sideward and rearward flight should be limited to low ground speeds. The helicopter is directionally stable in forward flight. In sideward and rearward flight, directional control is more difficult. During approach, or slow flight as the airspeed reaches about 17 to 20 KIAS, a mild vibration will be felt.

8.38 GROUND RESONANCE.

Ground resonance is a self-excited vibration created when a coupling interaction occurs between the movement of the main rotor blades and the helicopter. For this to happen, there must be some abnormal lead/lag blade condition which would dynamically unbalance the rotor and a reaction between the helicopter and ground, which could aggravate and further unbalance the rotor. Ground resonance can be caused by a blade being badly out of track, a malfunctioning damper, or a peculiar set of landing conditions. Ground resonance may occur when a wheel reaction aggravates an out-of-phase main rotor blade condition such as a hard one-wheel landing, resulting in maximum lead and lag blade displacement. This helicopter does not have a history of ground resonance. If it should occur, get the helicopter airborne. If this is not possible, immediately reduce collective pitch, place **ENG POWER CONT** levers **OFF**, and apply wheel brakes.

8.39 MANEUVERING FLIGHT.

8.39.1 Flight with External Loads. Refer to FM 55-450-1.

WARNING

Static electricity generated by the helicopter should be discharged before attempting a sling or rescue hoist pickup. Use a conductor between helicopter and the ground to discharge the static electricity.

Caution must be exercised when transporting external loads that exhibit unstable characteristics. These loads may

amplify any oscillation and cause the load to contact the aircraft.

a. Load bobble. In forward flight at the higher external cargo hook load weights, a slight vertical bobble may occasionally be noticed. If experienced, this bobble will increase in amplitude with a corresponding increase in airspeed or aggressiveness of maneuver. This bobble is caused by an external disturbance (e.g. turbulence or a control input) that triggers the natural elastic response of the sling. To correct, airspeed shall be decreased or limit aggressiveness of maneuver until bobble is eliminated and pilot is comfortable with the aircraft's control.

b. Stabilator angle in level flight. Due to the increased drag of external loads, collective position for a given level flight speed will be higher. Correspondingly, the stabilator angle will be more trailing edge down than usual. Since the surface area and inherent drag of each external load varies, exact guidance relative to how much more trailing edge down angle that results is not possible.

c. Collective friction. With external cargo hook sling loads, it is especially important to have collective friction set at a minimum of three pounds.

8.39.2 Flying Qualities with External ERFS Installed. **ERFS**

a. Pitch Attitude vs. Airspeed. The ERFS installation naturally results in increased drag. Since this drag vector is below the center of gravity of the helicopter, the pitch attitude will be more nose-down for any speed beyond 60 to 70 KIAS. At mid to high gross weights (and most especially at a forward CG) there is a slight pitch down at 50 to 55 KIAS. The installation of the ERFS results in a small increase in this nose-down tendency.

b. Tank Vibration. It will be observed that the right hand tank(s) will vibrate more than the left tank(s). This is a normal occurrence.

c. Stabilator Angle vs. Airspeed. With the increased drag of the ERFS, a given airspeed will require more collective which, due to the collective to stabilator coupling, results in a more trailing edge down stabilator angle. In the ferry configuration (full inboard 450-gallon tanks, full outboard 230-gallon tanks) the stabilator angle at higher speeds may be increased because of higher collective positions signal. This is normal as no stabilator program changes were made for the ERFS.

d. Roll Attitude Hold (FPS ON). With only the ERFs wings installed, the roll attitude hold feature of the FPS is not noticeably affected. With full outboard 230-gallon tanks there is a very slight degradation of roll attitude stability, evidenced by a slower return to trim after an excitation (gust). With four full 230-gallon tanks the return to trim is a bit slower and with full inboard 450-gallon tanks and full outboard 230-gallon tanks the return to trim is slower. Since the return to trim is affected by the roll inertia of the helicopter, it is therefore recommended that for a four tank configuration the outboard tanks be used first.

8.39.3 Collective Bounce/Pilot Induced Oscillation.

NOTE

The friction force refers to the breakaway force required to move the collective stick in an upward direction. The three pounds force is measured with the BOOST servo and SAS amplifiers operating and collective at mid-range.

To prevent vertical oscillation (collective bounce), the collective control system requires a minimum friction of three pounds measured at the collective head. Vertical oscillation can occur in any flight regime and may be caused by such events as SAS oscillation, turbulence, external load oscillation, and inadvertent pilot input into the collective. The oscillation causes the aircraft to vibrate. This vibration will be felt as a vertical bounce at approximately three cycles per second. If the severity of the oscillation is allowed to build, very high vibration levels will be experienced. During flight, if vertical oscillation is encountered, the pilot should remove the hand from the collective grip; this should eliminate the oscillation.

8.39A **700** TRANSIENT ROTOR DROOP CHARACTERISTICS

a. The T700 engine control system accurately maintains 100 % **RPM R** throughout the flight envelope for most

maneuvers. However, pilots should be aware that certain maneuvers performed with minimum collective applied will result in significant transient rotor droop. High density altitudes, heavy gross weights and operation at less than 100% **RPM R** will aggravate this condition.

b. During descent with little or no collective applied, **Ng SPEED** will be less than 80%. If % **RPM R** increases above 100%, the ECU torque motor input to the HMU is trimmed down in an attempt to restore 100% **RPM 1/2** and % **RPM R**. When collective is increased, the LDS input demands more power, but the ECU continues to trim down until % **RPM 1/2** returns to 100%. Since the **Ng SPEED** is at a slow speed, engine response time is greater. If rotor drag increases faster than the engine controller response, rotor droop occurs.

c. During aggressive level deceleration (quick stop) or right turn approach maneuvers as the collective is raised and the nose lowered, % **RPM R** may droop to 95% or lower for 1 - 2 seconds. % **RPM R** may then momentarily increase to 105-106% as the engine control system overcompensates for the reduced % **RPM 1/2**. Similar conditions of low collective, high % **RPM R**, and low **Ng SPEED** may be present during practice autorotations to a power recovery. After the flare as the nose is leveled and collective is increased, significant transient droop can occur. A rapid collective pull will aggravate the rotor droop.

d. Maneuvers that rapidly load the rotor system with no collective input can result in transient droops as low as 92%. Transient droop is more pronounced at higher altitudes since the HMU reduces **Ng SPEED** acceleration as barometric pressure decreases.

e. To minimize transient rotor droop, avoid situations which result in rapid rotor loading from low **Ng SPEED** and % **TRQ** conditions. Initiate maneuvers with collective inputs leading or simultaneous to cyclic inputs. During approach and landing, maintain at least 15% - 20% **TRQ** and transient droop will be minimal as hover power is applied.

Section V ADVERSE ENVIRONMENTAL CONDITIONS

8.40 GENERAL.

This section informs the crewmembers of the special precautions and procedures to be followed during the various weather and climatic conditions that may be encountered. This will be additional material to that already covered in other chapters regarding the operation of the various helicopter systems. Refer to FM 1-202 for cold weather operations.

8.41 COLD WEATHER OPERATION.

The basic helicopter with normal servicing can operate at temperatures down to -34°C (-29°F).

WARNING

Static electricity generated by the helicopter should be discharged before attempting a sling or rescue hoist pickup. In cold, dry climatic conditions static electricity buildups are large. Use a conductor between the helicopter and the ground to discharge the static charge. Delay lowering rescue hoist hook until helicopter is over the load, to lessen static charge buildup.

NOTE

During operation in cold weather, particularly when snow or moisture is present, the tail wheel locking indicating systems may give erroneous cockpit indications.

8.41.1 Cold Weather Preflight Check.

CAUTION

Ice removal shall never be done by scraping or chipping. Remove ice by applying heat or deicing fluid.

Blade deice operation with erosion strips installed may cause blade damage.

a. In addition to the checks in Section II check aircraft for ice or snow. If ice or snow is found, remove as much as possible by hand and thaw aircraft with heated air or deicing fluid before attempting start. Failure to remove ice and snow may cause damage.

b. Check main rotor head and blades, tail rotor, flight controls and engine inlets and hand holds for ice and snow. Failure to remove snow and ice accumulations can result in serious aerodynamic, structural effects in flight and serious foreign object damage if ice is ingested into the engine. Check **ENG POWER CONT** levers for freedom of movement.

c. On aircraft equipped with Extended Range Fuel System, check ESSS and 230/450-gallon fuel tank for ice or snow. Remove as much as possible by hand and then use heated air. Start APU and turn on pressure to both INBD and OUTBD fuel tanks. Wing-mounted pressure regulator may require heated air applied directly onto the exhaust vent protruding from the ESSS wing. After regulator valve is operating and fuel tanks are pressurized, leave system on. **DO NOT TURN OFF PRESSURE SWITCHES OR PRESSURE REGULATORS MAY FREEZE.**

d. When parking the helicopter in temperatures below freezing, the gust lock may seize due to frozen moisture in rod assembly. Normal operations may be returned by warming the assembly. Main rotor tiedowns may be used in lieu of gust lock to meet parking requirements.

8.41.2 Cold Weather Control Exercise. After starting the APU, the controls must be exercised when operating in a temperature range of -17°C (1°F) and below. The control exercise is required

- a. At temperatures between -17°C (1°F) and -31°C (-24°F), cycle collective control slowly for 1 minute.
 - (1) Move collective stick grip up about 3 inches from lower stop, and down again 30 times during 1 minute of control cycling in step a.
 - (2) Move each tail rotor pedal alternately through 3/4-inch of travel from neutral position 30 times during 1 minute of control cycling in step a.
- b. At temperatures between -31°C (-24°F) and -43°C (-45°F), cycle collective slowly for 2 minutes.

- (1) Move collective stick grip up about 1-1/2 inches from lower stop and down again during first minute, and 3 inches of travel during second minute of control cycling in step b.
- (2) Move each tail rotor pedal alternately through 3/8-inch of travel from neutral position during first minute and 3/4-inch of travel during second minute of control cycling in step b.
- c. At temperatures between -43°C (-45°F) and -54°C (-65°F), cycle collective stick grip slowly for 5 minutes.

Move collective and pedals through travel for times shown below:

<u>Collective Travel (Approximately)</u>	<u>Pedals Travel (Approximately)</u>	<u>Time Duration</u>
3/4-inch	1/8-inch	First minute
1-1/2 inches	1/4-inch	Second minute
1-3/4 inches	1/2-inch	Third minute
2-1/2 inches	5/8-inch	Fourth minute
3 inches	3/4-inch	Fifth minute

8.41.3 Engine Operation.

a. Even though cold weather does not particularly affect the engine itself, it still causes the usual problems of ice in the fuel lines, control valves, and fuel sumps, which frequently prevent a successful cold weather start. It may be found that certain elements or accessories need preheating.



When starting an engine that has been exposed to low temperatures, watch for rise in TGT TEMP within 45 seconds. If no TGT TEMP rise is evident, manually prime the engine and attempt another engine start. If there is no overboard fuel flow during prime, inspect for ice in the sumps and filters. During cold weather operation, allow longer warm-up period

to bring transmission oil temperature up to desired operating range refer to Chapter 5. Monitor oil pressure and temperature closely. When advancing the power control levers, maintain transmission oil pressure in normal operating range.

b. When starting in cold weather below -40°C (-40°F), if light-off does not occur within 45 seconds after initial indication of **Ng SPEED** move **ENG POWER CONT** lever for the affected engine back to **OFF**, with the engine shutdown move the **ENG POWER CONT** lever from **OFF** to **FLY**, if the force required to move the **ENG POWER CONT** lever is higher than normal, suspect possible frozen PAS cable. This situation may require maintenance prior to attempting another start. If force is normal then attempt another start. If light-off still does not occur within 45 seconds, abort start and do the following:

- (1) **ENG POWER CONT** lever(s) - Hold at **LOCKOUT**.
- (2) **FUEL BOOST PUMP CONTROL** switch(es) - **ON** until crewmember reports fuel from the overflow drain.
- (3) **FUEL BOOST PUMP CONTROL** switch(es) - **OFF**.
- (4) **ENG POWER CONT** lever(s) - **OFF**.
- (5) Attempt another start.

8.41.4 Engine Oil System Characteristics.

a. It is normal to observe high engine oil pressure during initial starts when the ambient temperature is 0°C (32°F) or below. Run engine at idle until oil pressure is within limits. Oil pressure should return to the normal range after operating 5 minutes. However, time required for warm-up will depend on temperature of the engine and lubrication system before start.

b. During starts in extreme cold weather (near -54°C (-65°F)), the following oil pressure characteristics are typical:

- (1) Oil pressure may remain at zero for the first 20 to 30 seconds after initiating the start. Abort the start if oil pressure does not register within 1 minute after initiating a start.
- (2) Once oil pressure begins to indicate on the gage, it will increase rapidly and it will exceed

the limit. This condition is normal. The time for oil pressure to decrease will depend on the ambient temperature, but should be normal within 5 minutes after starting the engine.

- (3) Oil pressure may increase above the maximum pressure limit if the engine is accelerated above idle while oil temperature is within normal operating range. The pressure will decrease to within the normal operating range as the oil temperature increases.

c. It is normal for the **OIL FLTR BYPASS** caution light to be on when starting an engine with oil temperatures below normal because of high oil viscosity and the accumulation of oil filter contaminants. When the engine oil temperature reaches about 38°C (100°F) during warm-up, the light should go off.

8.41.5 Taxiing. The helicopter should not be taxied until all engine temperatures and system pressures are within the normal range. All taxiing should be done at low speeds with wide-radius turns. If the tires are frozen to the surface, a slight yawing motion induced by light pedal application should break them free. Taxiing in soft snow requires higher than normal power.

8.42 DESERT AND HOT WEATHER OPERATION.

Prolonged hovering flight in hot weather 35°C (95°F) at higher gross weight may cause transmission oil temperature to rise into the yellow precautionary range. Hovering operations in the precautionary range under those conditions may be considered normal.

8.42.1 Taxiing and Ground Operation. Braking and ground operation should be minimized to prevent system overheating. During ground operations, if engine oil pressure falls into the red gage range when the power control lever is in the idle position and/or the engine oil pressure caution light comes on when the power control lever is in the idle position, slightly advance the power control lever. If the engine oil pressure returns to the yellow range and the engine oil pressure caution light extinguishes, engine oil pressure is acceptable.

8.43 IN-FLIGHT.

8.43.1 Thunderstorm Operation.



Avoid flight in or near thunderstorms, especially in areas of observed or anticipated lightning discharges.

a. Tests have shown that lightning strikes may result in loss of automatic flight controls (including stabilator), engine controls or electrical power. The high currents passing through the aircraft structure are expected to produce secondary effects whereby damaging voltage surges are coupled into aircraft wiring.

b. If a lightning strike occurs whereby all aircraft electrical power and electronics subsystems and controls are lost (including the engine 700 ECU/ 701C DEC and the engine-driven alternator), both engines go immediately to maximum power with no temperature limiter or overspeed protection. In addition, the 701C engine overspeed may result in single or dual-engine shutdown without automatic relight.

8.43.2 Turbulence.

a. Recommended maximum turbulence penetration airspeeds. For moderate turbulence, limit airspeed to the MAX RANGE (Chapter 7) or Vne minus 15 knots, whichever is less.

b. In turbulent air - Maintain constant collective and use the vertical situation indicator as the primary pitch instrument. The altimeter and vertical velocity indicator may vary excessively in turbulence and should not be relied upon. Airspeed indication may vary as much as 40 KIAS. By maintaining a constant power setting and a level-flight attitude on the vertical situation indicator, airspeed will remain relatively constant even when erroneous readings are presented by the airspeed indicator.

8.43.3 Ice and Rain Operation.



Operation in rain will result in significant damage to the blade erosion kit materials and should be avoided.

At airspeeds greater than 120 KIAS or during periods of reduced rain intensity the windshield wipers may slow noticeably. If this occurs, wipers must be parked immediately to avoid wiper motor failure.

8.43.4 In-Flight Icing.



Activation of anti-ice systems after entry into potential icing conditions creates the possibility of engine FOD caused by ice shedding. The ice detector has been designed primarily as a sensor to indicate the requirement for activation of the blade deice system.

- a. All anti-ice systems must be turned on prior to entering visible moisture at ambient temperatures of 4°C (39°F) or less.
- b. If icing conditions are encountered, turn on all anti-icing equipment immediately. If torque required increases 20% above that required for level flight at the airspeed being maintained before entering icing, exit the icing environment or land as soon as possible. A 20% torque increase indicates that normal autorotational rotor rpm may not be possible, should dual-engine failure occur.
- c. When the helicopter is equipped with an operating blade deice, and icing conditions are encountered, a recurring torque increase up to 14% per engine may be experi-

enced during normal operation of the blade deice system because of ice build-up. The crew should closely monitor engine instruments to prevent exceeding limits and/or rotor droop. Significant power losses and increased fuel consumption will occur with the activation of engine inlet anti-icing systems. Refer to Chapter 7 for torque available. The main rotor hub and the blades collect ice before initiation of a deice cycle. When enough ice has collected on the blades, moderate vibration levels of short duration can be expected in controls and airframe during normal deicing cycles. If the blade deice system is not operating, unbalanced loads of ice, resulting from asymmetric shedding, may cause severe vibrations. However, these vibrations normally subside after 30 to 60 seconds when ice from other blades is shed.

- d. **ERFS AFMS** When helicopter is equipped with external extended range fuel system turn on pressure to both INBD and OUTBD fuel tanks. This will prevent ice accumulation and assure pneumatic pressure for fuel transfer.

NOTE

After pressurizing the external extended range fuel tanks, **DO NOT TURN OFF** if ambient temperature is below 4°C (39°F).

8.43.5 Ground Operations.

- a. Strong gusty winds may cause increased flapping of the main rotor blades during shutdown following an icing encounter, because the anti-flap restrainers may be frozen in the fly position.
- b. During flight in icing conditions when droop stop heaters are not installed or fail to operate properly, the droop stop hinges may become iced, resulting in the droop stops not returning to the static position during rotor coast down. When the droop stops do not return to the static position, the main rotor blades may droop to within 4 feet of the ground during shutdown. Strong gusty winds may also cause excessive flapping of the main rotor blades, presenting the additional hazard of potential contact with the aft fuselage. If the droop stops are suspected to be stuck in the fly position, caution must be taken during shutdown to be sure personnel remain clear of the helicopter.

CHAPTER 9 EMERGENCY PROCEDURES

Section I AIRCRAFT SYSTEMS

9.1 HELICOPTER SYSTEMS.

This section describes the helicopter systems emergencies that may reasonably be expected to occur and presents the procedures to be followed. Emergency operation of mission equipment is contained in this chapter, insofar as its use affects safety of flight. Emergency procedures are given in checklist form when applicable. A condensed version of these procedures is contained in the condensed checklist TM 1-1520-237-CL.

9.2 IMMEDIATE ACTION EMERGENCY STEPS.

NOTE

The urgency of certain emergencies requires immediate and instinctive action by the pilot. The most important single consideration is helicopter control. All procedures are subordinate to this requirement. The **MASTER CAUTION** should be reset after each malfunction to allow systems to respond to subsequent malfunctions. If time permits during a critical emergency, transmit MAYDAY call, set transponder to emergency, jettison external stores if required, turn off boost pumps, and lock shoulder harnesses.

Those steps that shall be performed immediately in an emergency situation are underlined. These steps must be performed without reference to the checklist. Nonunderlined steps should be accomplished with use of the checklist.

9.3 DEFINITION OF EMERGENCY TERMS.

For the purpose of standardization, these definitions shall apply.

a. The term LAND AS SOON AS POSSIBLE is defined as landing at the nearest suitable landing area (e.g., open field) without delay. (The primary consideration is to ensure the survival of occupants.)

b. The term LAND AS SOON AS PRACTICABLE is defined as landing at a suitable landing area. (The primary consideration is the urgency of the emergency.)

c. The term AUTOROTATE is defined as adjusting the flight controls as necessary to establish an autorotational descent and landing.

d. The term EMER ENG SHUTDOWN is defined as engine shutdown without delay. Engine shutdown in flight is usually not an immediate-action item unless a fire exists. Before attempting an engine shutdown, identify the affected engine by checking **ENG OUT** warning lights, **% RPM**, **% TRQ**, **ENG OIL PRESS**, **TGT TEMP**, and **Ng SPEED**.

1. ENG POWER CONT lever(s) - **OFF**.
2. ENG FUEL SYS selector(s) - **OFF**.
3. FUEL BOOST PUMP CONTROL switch(es) - **OFF**.

CAUTION

If **TGT** rises above **538°C** after shutdown, place **AIR SOURCE HEAT/START** switch as required, turn **ENGINE IGNITION** switch **OFF**, and press starter to motor engine for **30 seconds** or until **TGT TEMP** decreases below **538°C**.

e. The term LOCKOUT is defined as manual control of engine RPM while bypassing **700** ECU, or **701C** DEC functions. Bypass of the engine control will be required when **% RPM 1** or **2** decreases below normal demand speed.

CAUTION

When engine is controlled with **ENG POWER CONT** lever in **LOCKOUT**, engine response is much faster and **TGT limiting system** is inoperative. Care must be taken not to exceed **TGT limits** and keeping **% RPM R** and **% RPM 1** and **2** in operating range.

TM 1-1520-237-10

ENG POWER CONT lever - Pull down and advance full forward while maintaining downward pressure, then adjust to set **% RPM R** as required. Engine control malfunctions can result in **% RPM R** increasing or decreasing from normal demand speed. Under certain failure conditions, **% TRQ**, **% RPM**, and **Ng SPEED** may not be indicating and the possibility of the **ENG OUT** warning light and audio activating exists. The most reliable indication of engine power will be **TGT TEMP**.

f. The term **EMER APU START** is defined as APU start to accomplish an emergency procedure.

1. **FUEL PUMP** switch - **APU BOOST**.
2. **APU CONTR** switch - **ON**.

9.4 AFTER EMERGENCY ACTION.

After a malfunction of equipment has occurred, appropriate emergency actions have been taken and the helicopter is on the ground, an entry shall be made in the Remarks Section of DA Form 2408-13-1 describing the malfunction. Ground and flight operations shall be discontinued until corrective action has been taken.

9.5 EMERGENCY EXITS.

Emergency exits are shown in Figure 9-1. Emergency exit release handles are yellow and black striped.

WARNING

For helicopters without a roll-trim actuator, the cyclic shall be held at all times with the rotor turning. In cases where emergency exit is required prior to rotor coasting to a stop, make sure that the cyclic stick is centered until the last crewmember can depart the cockpit. Since the main rotor shaft has a 3° forward tilt, an exit to the right rear or left rear will provide the greatest rotor clearance safety.

a. Each cockpit door is equipped with a jettison system for emergency release of the door assembly. Jettison is done by pulling a handle marked **EMERGENCY EXIT PULL**, on the inside of the door (Figure 9-1). To release the door, the jettison handle is pulled to the rear; the door may then be jettisoned by kicking the lower forward corner of the door. On helicopters equipped with jettisonable cockpit door windows if the door fails to jettison, the windows may be removed by pulling the emergency strap inward.

b. Cabin door window jettison. To provide emergency exit from the cabin, two jettisonable windows are installed in each cabin door. To release the windows, a handle (under a jettison lever guard) marked **EMERGENCY EXIT PULL AFT**, (left side; right side, **PULL FWD**) on the inside of the cabin door (Figure 9-1), is moved in the direction of the arrow, releasing the windows. The windows can then be pushed out.

9.6 EMERGENCY EQUIPMENT (PORTABLE).

Emergency equipment consists of two hand held fire extinguishers, one crash ax, and three first aid kits, as shown in Figure 9-1.

9.7 ENGINE MALFUNCTION - PARTIAL OR COMPLETE POWER LOSS.

WARNING

Prior to movement of either power-control lever, it is imperative that the malfunctioning engine and the corresponding power-control lever be identified. If the decision is made to shut down an engine, take at least five full seconds while retarding the ENG POWER CONT lever from FLY to IDLE, monitoring % TRQ, Ng SPEED, TGT TEMP, % RPM, and ENG OUT warning light on.

The various conditions under which engine failure may occur, prevent a standard procedure. A thorough knowledge of emergency procedures and flight characteristics will enable the pilot to respond correctly and automatically in an emergency. The engine instruments often provide ample warning of a malfunction before actual engine failure. The indications of engine malfunction, either partial or complete power loss, may be as follows: Changes in affected engine **% RPM**, **TGT TEMP**, **Ng SPEED**, **% TRQ**, **ENG OIL PRESS**, **% RPM R**, **LOW ROTOR RPM** and/or **ENG OUT** warning lights and audio, and change in engine noise. The amount of change in each depends upon the type of failure, e.g., compressor stall, as opposed to complete power loss on one or both engines.

9.8 FLIGHT CHARACTERISTICS.

DUAL-ENGINE FAILURE: The flight characteristics and the required crewmember control responses after a dual-engine failure are similar to those during a normal power-on descent. Full control of the helicopter can be maintained during autorotational descent. In autorotation,

as airspeed increases above 70 - 80 KIAS, the rate of descent and glide distance increase significantly. As airspeed decreases below 64 KIAS, the rate of descent will increase and glide distance will decrease.

SINGLE-ENGINE FAILURE: When one engine has failed, the helicopter can often maintain altitude and airspeed until a suitable landing site can be selected. Whether or not this is possible becomes a function of such combined variables as aircraft weight, density altitude, height above ground, airspeed, phase of flight, single engine capability, and environmental response time and control technique may be additional factors. In addition, these factors should be taken into consideration should the functioning engine fail and a dual-engine failure results.

9.9 SINGLE-ENGINE FAILURE - GENERAL.

WARNING

When the power available during single engine operation is marginal or less, consideration should be given to jettisoning the external stores. The engine anti-ice and cabin heater switches should be turned off as necessary to ensure maximum power is available on the remaining engine.

Crewmember recognition of a single-engine failure and subsequent action are essential and should be based on the following general guidelines. At low altitude and low airspeed, it may be necessary to lower the collective only enough to maintain % RPM R (normal range). At higher altitude, however, the collective may be lowered significantly to increase % RPM R to 100 percent. When hovering in ground effect, the collective should be used only as required to cushion the landing, and the primary consideration is in maintaining a level attitude. In forward flight at low altitude (as in takeoff), when a single-engine capability to maintain altitude does not exist, a decelerating attitude will initially be required to prepare for landing. Conversely, if airspeed is low and altitude sufficient, the helicopter should be placed in an accelerating attitude to gain sufficient airspeed for single-engine fly away to a selected landing site. The light regions in the height velocity avoid region diagram s (Figures 9-2 and 9-3) define the ground speed and wheel-height combinations that will permit a safe landing in the event of an engine failure for various gross weights at both sea level 15°C (59°F), and 4,000 feet/35°C (95°F), ambient condition.

9.10 SINGLE-ENGINE FAILURE.

WARNING

Do not respond to ENG OUT warning light and audio until checking TGT TEMP, Ng SPEED, and % RPM 1 and 2.

1. Collective - Adjust to maintain % RPM R.
2. External cargo/stores - Jettison (if required).

If continued flight is not possible:

3. LAND AS SOON AS POSSIBLE.

If continued flight is possible:

4. Establish single-engine airspeed.
5. LAND AS SOON AS PRACTICABLE.

9.11 ENGINE RESTART DURING FLIGHT.

After an engine failure in flight, an engine restart may be attempted. If it can be determined that it is reasonably safe to attempt a start, the APU should be used. Use of a cross-bleed start could result in a power loss of up to 18% on the operational engine.

9.12 DUAL-ENGINE FAILURE - GENERAL.

a. If both engines fail, immediate action is required to make a safe autorotative descent. The altitude and airspeed (Figure 9-4) at which a two-engine failure occurs will dictate the action to be taken. After the failure, main rotor rpm will decay rapidly and the aircraft will yaw to the left. Unless a two-engine failure occurs near the ground, it is mandatory that autorotation be established immediately. During cruise, reduce collective immediately to regain % RPM R and then adjust as required to maintain % RPM within power off rotor speed limits. The cyclic should be adjusted as necessary to attain and maintain the desired airspeed. The recommended airspeed for autorotation is 80 KIAS. Autorotation below 80 knots is not recommended because the deceleration does not effectively arrest the rate of descent. Adjusting the cyclic and collective control to maintain 100% RPM R and 110 KIAS (100 KIAS high drag) will result in achieving the maximum glide distance. A landing area must be selected immediately after both engines fail. Throughout the descent, adjust collective as

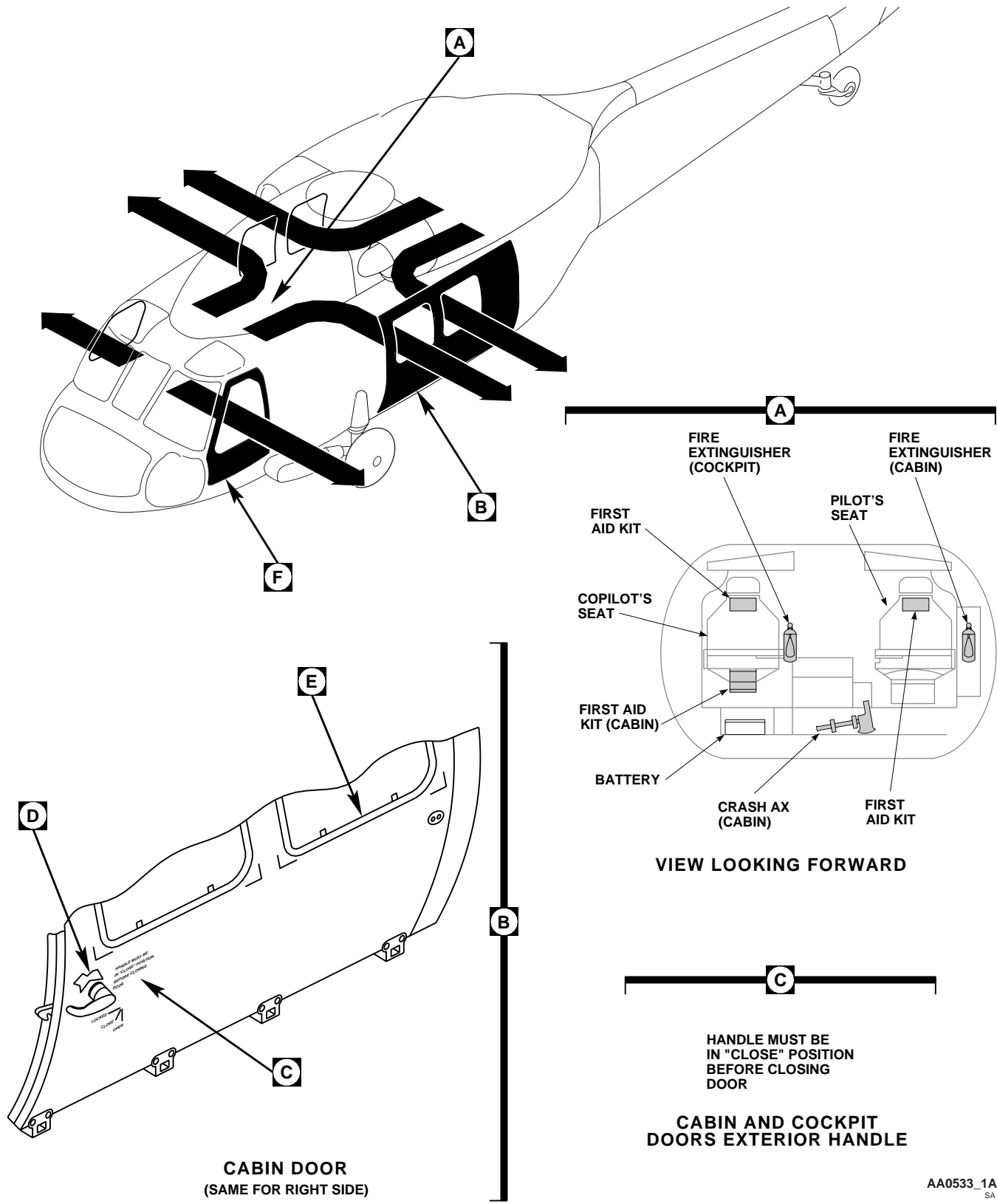
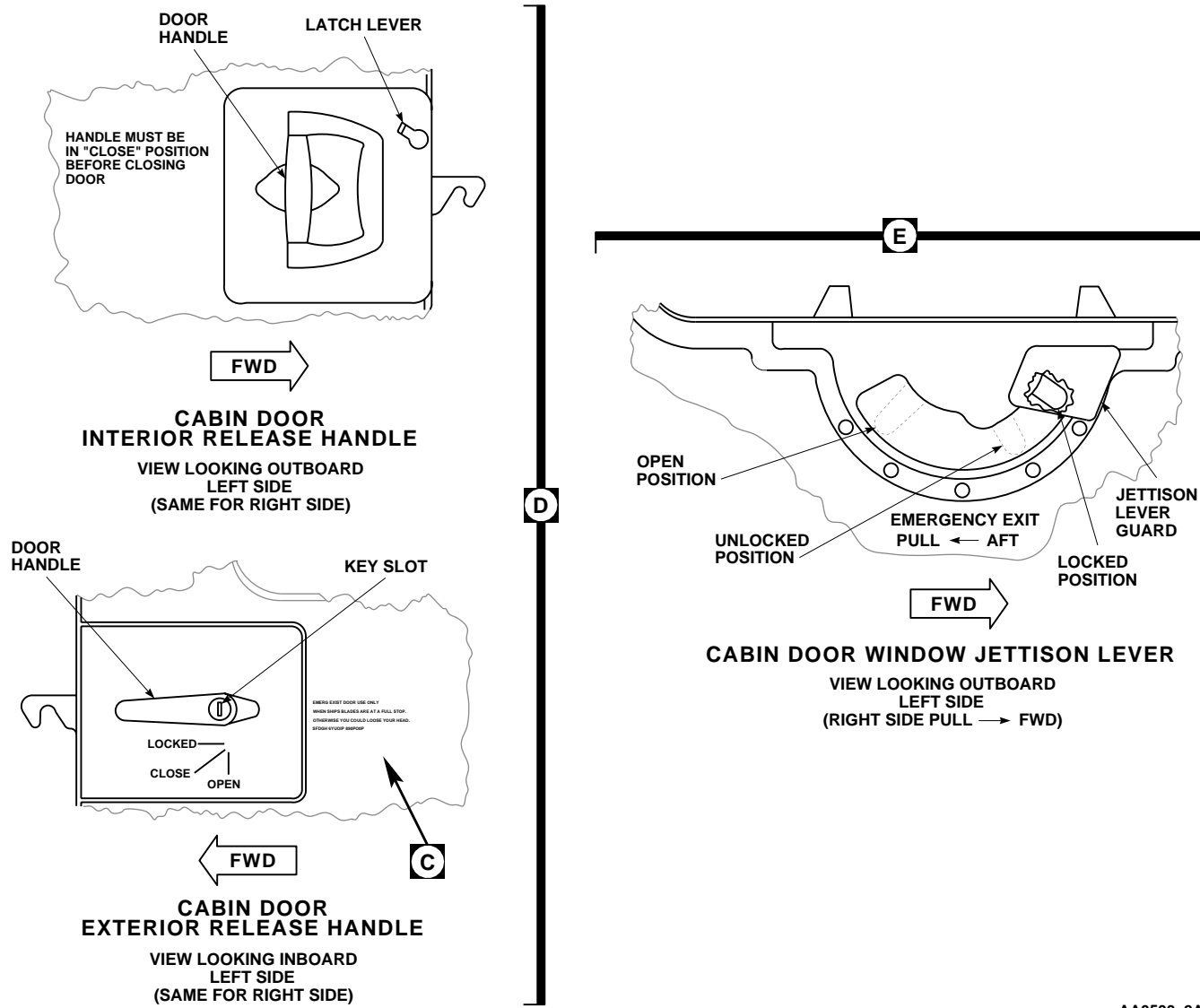

Figure 9-1. Emergency Exits and Emergency Equipment Diagram (Sheet 1 of 3)



AA0533_2A
SA

Figure 9-1. Emergency Exits and Emergency Equipment Diagram (Sheet 2 of 3)

necessary to maintain % RPM R within normal range. Figure 5-1 shows the rotor limitations. % RPM R should be maintained at or slightly above 100 percent to allow ample rpm before touchdown.

b. Main rotor rpm will increase momentarily when the cyclic is moved aft with no change in collective pitch setting. An autorotative rpm of approximately 100 percent provides for a good rate of descent. % RPM R above 100 percent will result in a higher rate of descent. At 50 to 75 feet AGL, use aft cyclic to decelerate. This reduces airspeed and rate of descent and causes an increase in % RPM R. The degree of increase depends upon the amount and rate of deceleration. An increase in % RPM R can be desirable in that more inertial energy in the rotor system

will be available to cushion the landing. Ground contact should be made with some forward speed. Pitch attitudes up to 25° at the point of touchdown normally result in an adequate deceleration and safe landing. If a rough area is selected, a steeper deceleration and a touchdown speed as close to zero as possible should be used. With pitch attitude beyond 25° there is the possibility of ground contact with the stabilator trailing edge. It is possible that during the autorotative approach, the situation may require additional deceleration. In that case, it is necessary to assume a landing attitude at a higher altitude than normal. Should both engines fail at low airspeed, initial collective reduction may vary widely. The objective is to reduce collective as necessary to maintain % RPM R within normal range. In some

TM 1-1520-237-10

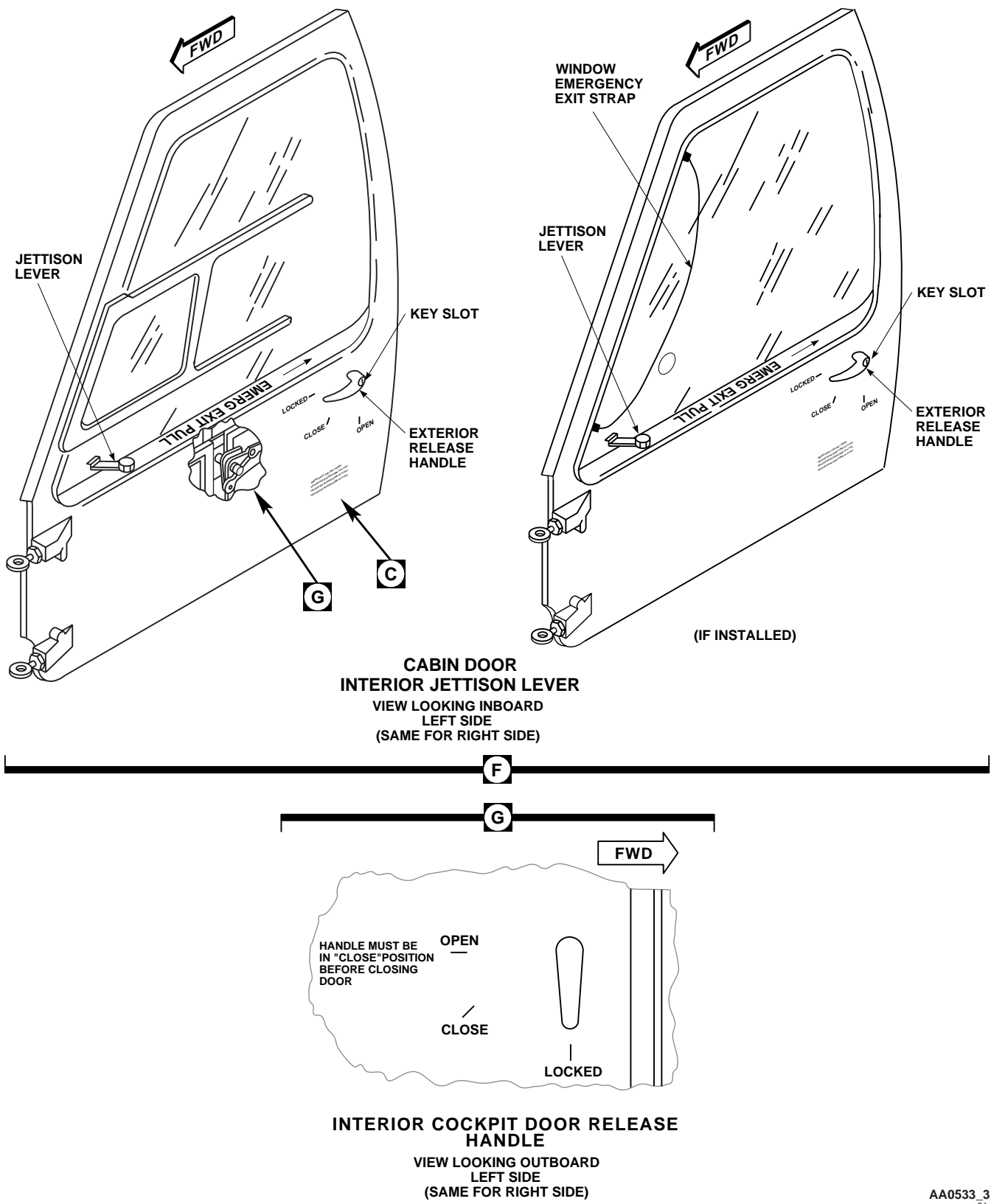

AA0533_3
SA

Figure 9-1. Emergency Exits and Emergency Equipment Diagram (Sheet 3 of 3)

instances at low altitude or low airspeed, settling may be so rapid that little can be done to avoid a hard-impact landing. In that case, it is critical to maintain a level landing attitude. Cushion the landing with remaining collective as helicopter settles to the ground. At slow airspeeds, where altitude permits, apply forward cyclic as necessary to increase airspeed to about 80 KIAS. Jettison external cargo and stores as soon as possible to reduce weight and drag, improve autorotational performance, and reduce the chance of damage to the helicopter on landing.

9.13 DUAL-ENGINE FAILURE.

WARNING

Do not respond to ENG OUT warning lights and audio until checking TGT TEMP and % RPM R.

AUTOROTATE.

9.14 DECREASING % RPM R.

If an engine control unit fails to the low side and the other engine is unable to provide sufficient torque, % RPM R will decrease.

CAUTION

When engine is controlled with engine power-control lever in lockout, engine response is much faster and the TGT limiting system is inoperative. Care must be taken not to exceed TGT limits and keeping % RPM R and % RPM 1 and 2 in operating range.

NOTE

If %RPM R reduces from 100% to 95-96% during steady flight, check %TRQ 1 and 2.

If %TRQ 1 and 2 are equal, attempt to increase %RPM R with RPM trim switch.

1. Collective - Adjust to control % RPM R.
2. ENG POWER CONT lever - LOCKOUT low % TRQ/TGT TEMP engine. Maintain % TRQ approximately 10% below other engine.
3. LAND AS SOON AS PRACTICABLE.

9.15 INCREASING % RPM R.

% RPM R increasing will result from an engine control system failing to the high side. % RPM 1 and 2 (Np) will increase with the rotor % RPM R. Increasing the collective will probably increase the malfunctioning engine's TGT TEMP above 900°C. If an engine control unit fails to the high side:

1. ENG POWER CONT lever - Retard high % TRQ/TGT TEMP engine, maintain % TRQ approximately 10% below other engine.
2. LAND AS SOON AS PRACTICABLE.

If the affected engine does not respond to ENG POWER CONT lever movement in the range between FLY and IDLE, the HMU may be malfunctioning internally.

If this occurs:

3. Establish single engine airspeed.
4. Perform EMER ENG SHUTDOWN (affected engine).

UH-60A/EH-60A HEIGHT VELOCITY AVOID REGIONS SINGLE-ENGINE FAILURE

EXAMPLE

WANTED:

A TAKEOFF PROFILE WHICH WILL PERMIT A SAFE LANDING AFTER AN ENGINE SUDDENLY BECOMES INOPERATIVE.

KNOWN:

AIRCRAFT GROSS WEIGHT = 22,000 LBS
 AMBIENT CONDITIONS:
 TEMPERATURE = 15°C
 PRESSURE ALTITUDE = SEA LEVEL
 WIND = 0 KTS

METHOD:

TRACE ALONG GROSS WEIGHT LINE NOTING WHEEL HEIGHT / AIRSPEED COMBINATIONS WHICH WILL KEEP THE TAKEOFF PROFILE BELOW AND TO THE RIGHT OF THE AVOID REGION.

POINT	AIRSPEED	WHEEL HEIGHT
A	10	10
B	20	10
C	30	15
D	42	155

SEA LEVEL STANDARD

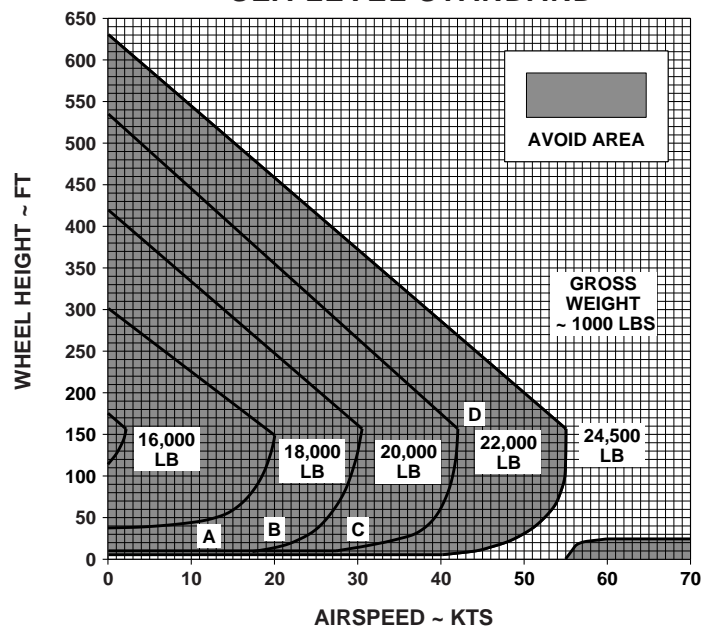

4000 FT 35°C (95°F)

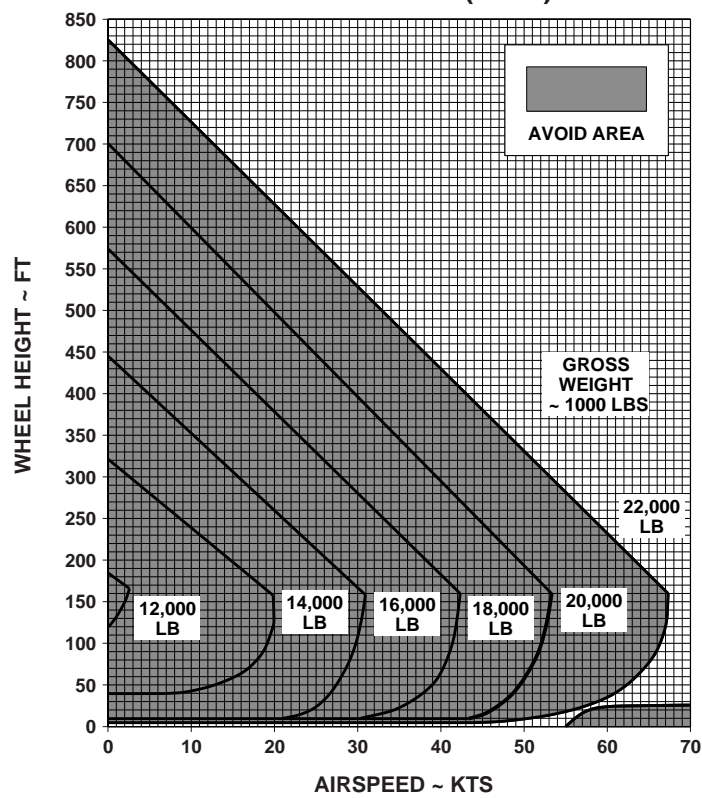

NOTE:

BASED ON AN ETF OF .85 OF MAXIMUM RATED POWER. WEIGHTS GREATER THAN 22,000 LBS ARE FOR FERRY MISSION ONLY, FOR WHICH A FLIGHT RELEASE IS REQUIRED.

DATA BASIS: CALCULATED

AA0673C
SA

Figure 9-2. Height Velocity Diagram UH-60A EH

TM 1-1520-237-10

UH-60L HEIGHT VELOCITY AVOID REGIONS SINGLE ENGINE FAILURE

EXAMPLE

WANTED

A TAKEOFF PROFILE WHICH WILL PERMIT A SAFE LANDING AFTER AN ENGINE SUDDENLY BECOMES INOPERATIVE.

KNOWN

AIRCRAFT GROSS WEIGHT = 22,000 LBS
 AMBIENT CONDITIONS:
 TEMPERATURE = 15°C
 PRESSURE ALTITUDE = SEA LEVEL
 WIND = 0 KTS

METHOD

TRACE ALONG GROSS WEIGHT LINE NOTING WHEEL HEIGHT / AIRSPEED COMBINATIONS WHICH WILL KEEP THE TAKEOFF PROFILE BELOW AND TO THE RIGHT OF THE AVOID REGION.

POINT	AIRSPEED	WHEEL HEIGHT
A	10	21
B	20	33
C	30	150

SEA LEVEL STANDARD

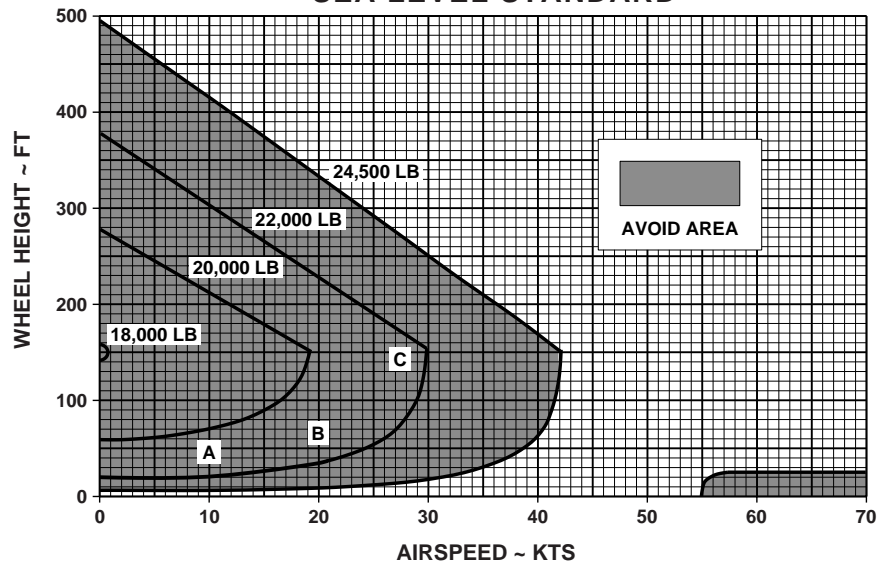

4000 FT 35 °C (95 °F)

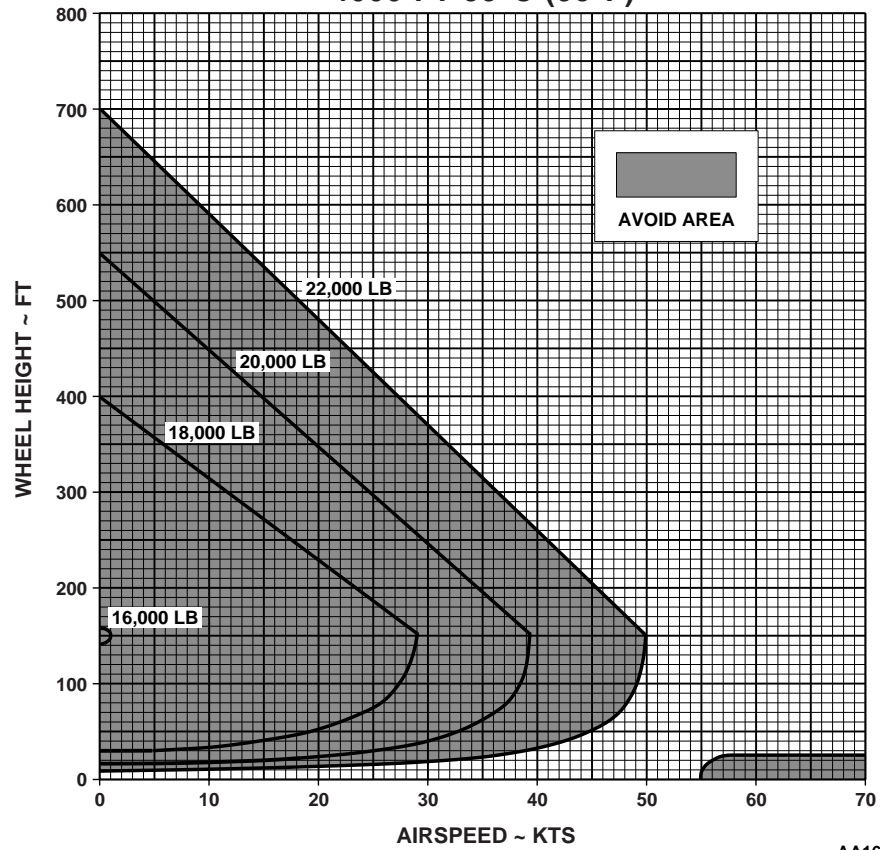

NOTE

BASED ON AN ETF OF .90 OF MAXIMUM RATED POWER.

DATA BASIS: ESTIMATED

AA1639A
SA

Figure 9-3. Height Velocity Diagram UH-60L

**AUTOROTATION
CLEAN CONFIGURATION
100% RPM R ZERO WIND**

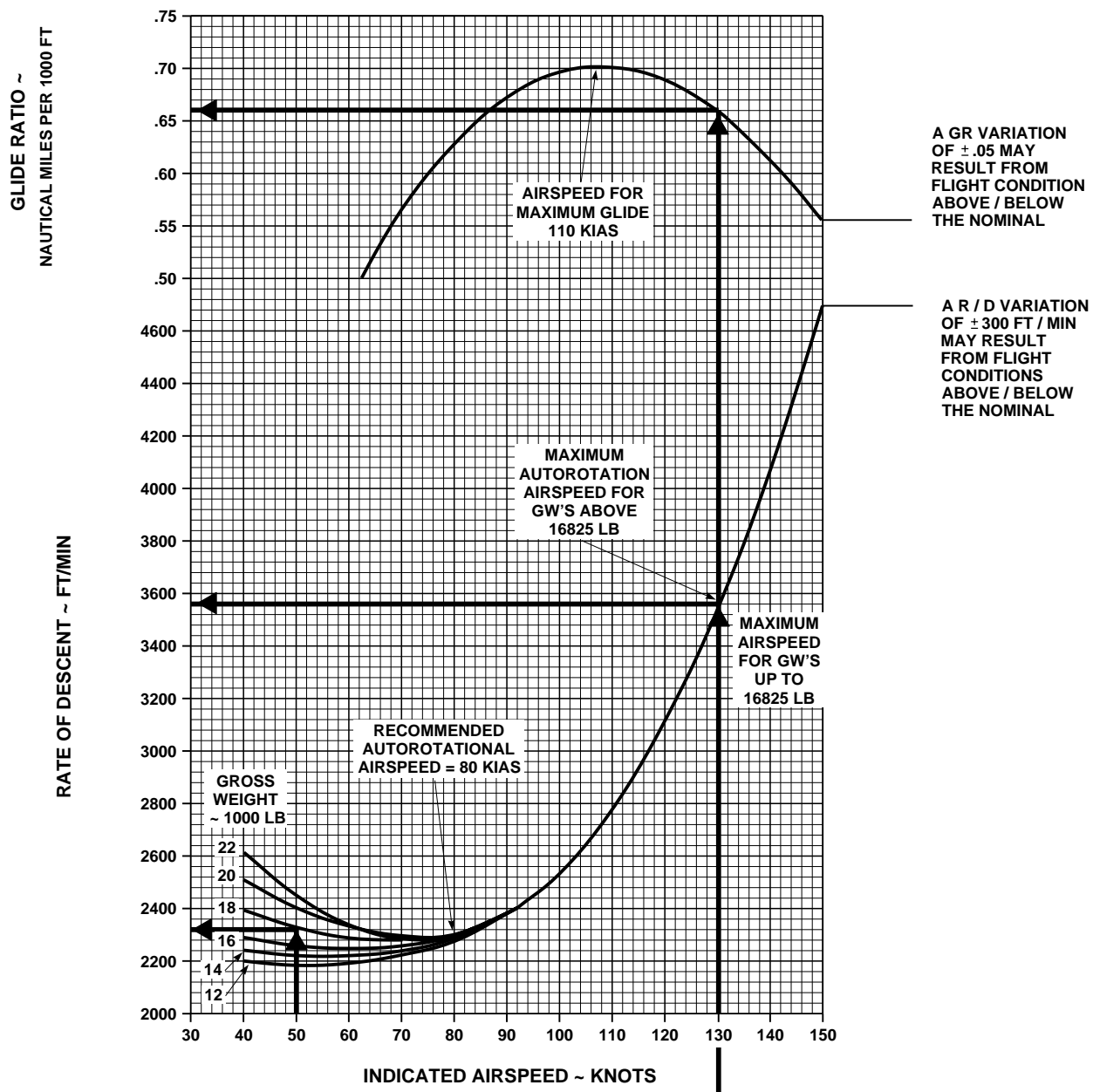

EXAMPLE

WANTED:
RATE OF DESCENT AND GLIDE RATIO IN STEADY
STATE AUTOROTATION AT IAS'S OF:
A. 130 KIAS
B. 50 KIAS

KNOWN:
RPM R = 100%
GROSS WEIGHT = 18,000 LB

METHOD:
A. ENTER AUTOROTATION CHART AT 130 KIAS,
MOVE UP TO INTERSECTION OF R / D LINE,
MOVE LEFT, READ RD = 3,560 FT / MIN
B. ENTER AUTOROTATION CHART AT 50 KIAS,
MOVE UP TO 18,000 LB GW LINE, MOVE LEFT,
READ R / D = 2,325 FT / MIN
THE GLIDE RATIO IS NOT PROVIDED FOR LOW
AIRSPEEDS

DATA BASIS: FLIGHT TEST

AA0322B
SA

Figure 9-4. Autorotative Glide Distance Chart

AUTOROTATION HIGH DRAG CONFIGURATION 100% RPM R ZERO WIND

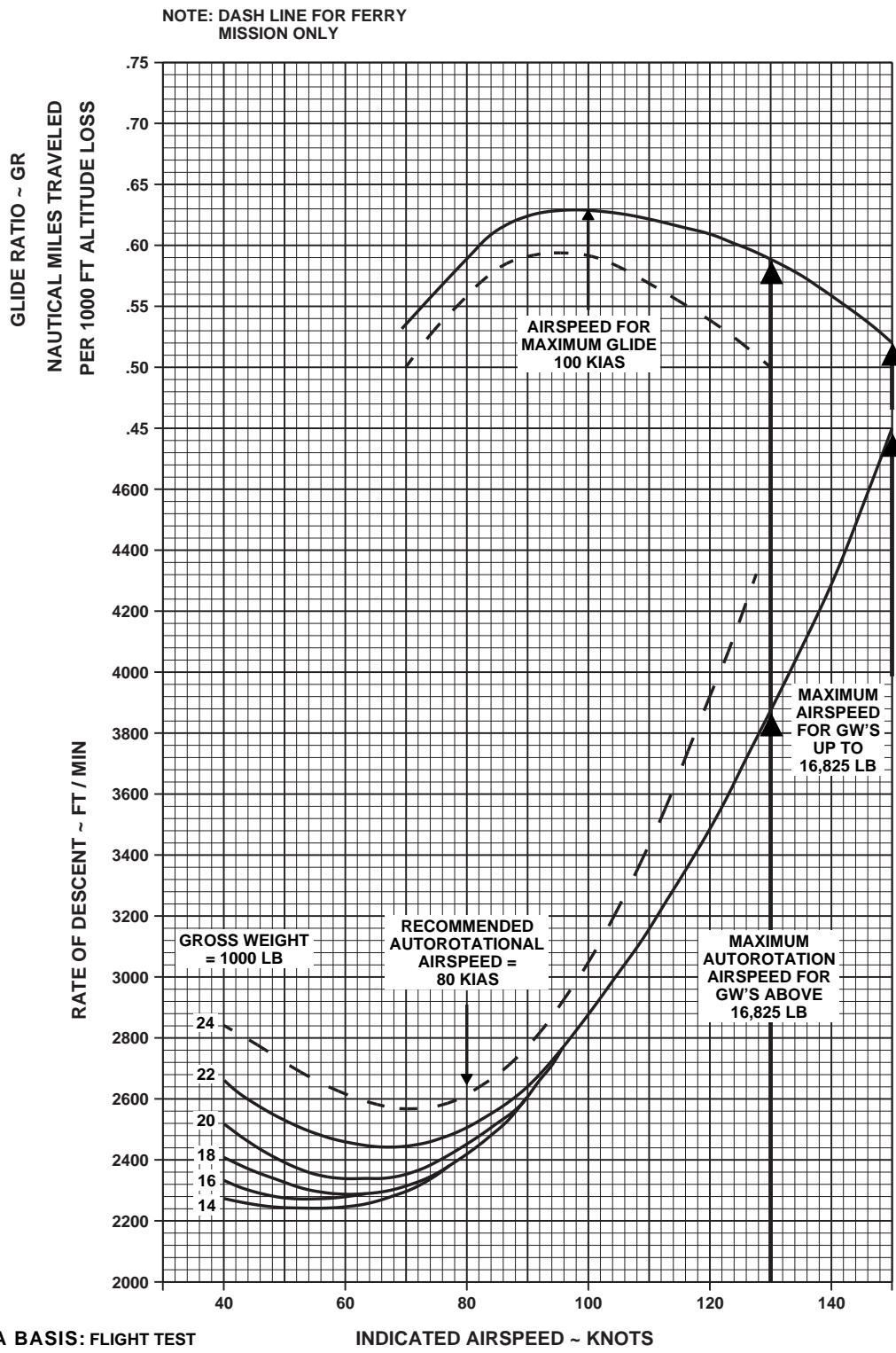

Figure 9-5. Autorotative Glide Distance Chart-High Drag

5. Refer to single engine failure emergency procedure.

9.16 % RPM INCREASING/DECREASING (OSCILLATION).

It is possible for a malfunction to occur that can cause the affected engine to oscillate. The other engine will respond to the change in power by also oscillating, usually with smaller amplitudes. The engine oscillations will cause torque oscillations. The suggested pilot corrective action is to pull back the **ENG POWER CONT** lever of the suspected engine until oscillation stops. If the oscillation continues, the **ENG POWER CONT** lever should be returned to **FLY** position and the other **ENG POWER CONT** lever pulled back until the oscillation ceases. Once the malfunctioning engine has been identified, it should be placed in **LOCKOUT** and controlled manually.

- ①. Slowly retard the **ENG POWER CONT** lever on the suspected engine.

If the oscillation stops:

- ②. Place that engine in **LOCKOUT** and manually control the power.

3. LAND AS SOON AS PRACTICABLE.

If the oscillation continues:

- ④. Place the **ENG POWER CONT** lever back to **FLY** and retard the **ENG POWER CONT** lever of the other engine.

When the oscillation stops:

- ⑤. Place the engine in **LOCKOUT**, manually control the power.

6. LAND AS SOON AS PRACTICABLE.

9.17 % TRQ SPLIT BETWEEN ENGINES 1 AND 2.

It is possible for a malfunction to occur that can cause a % TRQ split between engines without a significant change in % RPM R. The % TRQ split can be corrected by manual control of the **ENG POWER CONT** lever on the affected engine.

- ①. If **TGT TEMP** of one engine exceeds the limiter (700 849°C, 701C 872°C with low power engine above 50% **TRQ** or 896°C with low power engine below 50% **TRQ**), retard **ENG**

POWER CONT lever on that engine to reduce **TGT TEMP**. Retard the **ENG POWER CONT** lever to maintain torque of the manually controlled engine at approximately 10% below the other engine.

- ②. If **TGT TEMP** limit on either engine is not exceeded, slowly retard **ENG POWER CONT** lever on high % **TRQ** engine and observe % **TRQ** of low power engine.

- ③. If % **TRQ** of low power engine increases, **ENG POWER CONT** lever on high power engine - Retard to maintain % **TRQ** approximately 10% below other engine (The high power engine has been identified as a high side failure).

- ④. If % **TRQ** of low power engine does not increase, or % **RPM R** decreases, **ENG POWER CONT** lever - Return high power engine to **FLY** (The low power engine has been identified as a low side failure).

- ⑤. If additional power is required, low power **ENG POWER CONT** lever, momentarily move to **LOCKOUT** and adjust to set % **TRQ** approximately 10% below the other engine.

6. LAND AS SOON AS PRACTICABLE.

9.18 ENGINE COMPRESSOR STALL.

An engine compressor stall is normally recognized by a noticeable bang or popping noise and possible aircraft yaw. These responses are normally accompanied by the rapid increase in **TGT TEMP** and fluctuations in **Ng SPEED**, % **TRQ**, and % **RPM** reading for the affected engine. In the event of a compressor stall:

1. Collective - Reduce.

If condition persists:

- ②. **ENG POWER CONT** lever (affected engine) - Retard (**TGT TEMP** should decrease.)
- ③. **ENG POWER CONT** lever (affected engine) - **FLY**.

If stall condition recurs:

- ④. **EMER ENG SHUTDOWN** (affected engine).

TM 1-1520-237-10

5. Refer to single-engine failure emergency procedure.

9.19 ENGINE OIL FILTER BYPASS CAUTION LIGHT ON, ENGINE CHIP CAUTION LIGHT ON, ENG OIL PRESS HIGH/LOW, ENGINE OIL TEMP HIGH, ENGINE OIL TEMP CAUTION LIGHT ON, ENGINE OIL PRESS CAUTION LIGHT ON.

1. ENG POWER CONT lever - Retard to reduce torque on affected engine.

If oil pressure is below minimum limits or if oil temperature remains above maximum limits:

2. EMER ENG SHUTDOWN (affected engine).
3. Refer to single-engine failure emergency procedure.

9.20 ENGINE HIGH-SPEED SHAFT FAILURE.

Failure of the shaft may be complete or partial. A partial failure may be characterized at first by nothing more than a loud high-speed rattle and vibration coming from the engine area. A complete failure will be accompanied by a loud bang that will result in a sudden % **TRQ** decrease to zero on the affected engine. % **RPM** of affected engine will increase until overspeed system is activated.

1. Collective - Adjust.
2. EMER ENG SHUTDOWN (affected engine). Do not attempt to restart.
3. Refer to single-engine failure emergency procedure.

9.21 LIGHTNING STRIKE.

WARNING

Lightning strikes may result in loss of automatic flight control functions, engine controls, and/or electric power.

Lightning strike may cause one or both engines to immediately produce maximum power with no TGT limiting or overspeed protection. Systems instruments may also be inoperative. If this occurs, the flight crew would have to adjust to the malfunctioning engine(s) power-control lever(s) as required to control % **RPM** by sound and feel. If

practical, the pilot should reduce speed to 80 KIAS. This will reduce the criticality of having exactly correct rotor speed 100%.

1. ENG POWER CONT levers - Adjust as required to control % **RPM**.
2. LAND AS SOON AS POSSIBLE.

9.22 ROTORS, TRANSMISSIONS AND DRIVE SYSTEMS.

9.22.1 Loss of Tail Rotor Thrust. Failure of the tail rotor gearbox, intermediate gearbox or tail rotor drive shaft will result in a loss of tail rotor thrust. The nose of the helicopter will yaw right regardless of the airspeed at which the failure occurs. Continued level flight may not be possible following this type failure. Loss of tail rotor thrust at low speed will result in rapid right yaw. At higher airspeed, right yaw may develop more slowly but will continue to increase. Autorotation should be entered promptly. Retard **ENG POWER CONT** levers to **OFF** position during deceleration. Every effort should be made to establish and maintain an autorotative glide at or above 80 KIAS. This will maximize the effectiveness of the deceleration during the landing sequence. If autorotation entry is delayed, large sideslip angles can develop causing low indicated airspeed with the stabilator programming down. This can make it more difficult to establish or maintain adequate autorotative airspeed.

1. AUTOROTATE.
2. ENG POWER CONT levers - **OFF** (when intended point of landing is assured).

9.22.2 Loss of Tail Rotor Thrust at Low Airspeed/ Hover.

Loss of tail rotor thrust at slow speed may result in extreme yaw angles and uncontrolled rotation to the right. Immediate collective pitch reduction should be initiated to reduce the yaw and begin a controlled rate of descent. If the helicopter is high enough above the ground, initiate a power-on descent. Collective should be adjusted so that an acceptable compromise between rate of turn and rate of descent is maintained. At approximately 5 to 10 feet above touchdown, initiate a hovering autorotation by moving the **ENG POWER CONT** levers - **OFF**.

1. Collective - Reduce.
2. ENG POWER CONT levers - **OFF** (5 to 10 feet above touchdown).

9.22.3 TAIL ROTOR QUADRANT Caution Light On With No Loss of Tail Rotor Control.

WARNING

If the helicopter is shut down and/or hydraulic power is removed with one tail rotor cable failure, disconnection of the other tail rotor cable will occur when force from the boost servo cannot react against control cable quadrant spring tension. The quadrant spring will displace the cable and boost servo piston enough to unlatch the quadrant cable.

Loss of one tail rotor cable will be indicated by illumination of **TAIL ROTOR QUADRANT** caution light. No change in handling characteristics should occur.

LAND AS SOON AS PRACTICABLE.

9.22.4 TAIL ROTOR QUADRANT Caution Light On With Loss of Tail Rotor Control.

a. If both tail rotor control cables fail, a centering spring will position the tail rotor servo linkage to provide 10-1/2 degrees of pitch. This will allow trimmed flight at about 25 KIAS and 145 KIAS (these speeds will vary with gross weight). At airspeed below 25 and above 145 KIAS, right yaw can be controlled by reducing collective. Between 25 and 145 KIAS, left yaw can be controlled by increasing collective.

b. A shallow approach to a roll-on landing technique is recommended. During the approach, a yaw to the left will occur. As the touchdown point is approached, a mild deceleration should be executed to reduce airspeed. As collective is increased to cushion touchdown, the nose of the helicopter will yaw right. Careful adjustment of collective and deceleration should allow a tail-low touchdown with approximate runway alignment. Upon touchdown, lower collective carefully. Use brakes to control heading.

1. Collective - Adjust.
2. LAND AS SOON AS PRACTICABLE.

9.22.5 Pedal Bind/Restriction or Drive With No Accompanying Caution Light. If pedal binding, restriction, or driving occurs with no caution light the cause may not be apparent. A Stability Augmentation System/Flight Path Stabilization (SAS/FPS) computer induced yaw trim

malfunction can produce about 30 pounds at the pedal. An internally jammed yaw trim actuator can produce up to 80 pounds until clutch slippage relieves this force. The pilot can override any yaw trim force by applying opposite pedal firmly and then turning off trim. A malfunction within the yaw boost servo or tail rotor servo can produce much higher force at the pedals and the affected servo must be turned off. Hardover failure of the yaw boost servo will increase control forces as much as 250 pounds on the pedals.

1. Apply pedal force to oppose the drive.

2. TRIM switch - Off.

If normal control forces are not restored:

3. BOOST switch - Off.

If control forces, normal for boost off flight are not restored:

4. BOOST switch - ON.

5. TAIL SERVO switch - BACKUP, if tail rotor is not restored.

a. If the tail rotor quadrant becomes jammed, collective control is available, except that low collective with right pedal or high collective with a left pedal will be restricted. With a quadrant jam, complete collective travel is available for most control combinations, provided the pedals are allowed to move as the collective is displaced.

b. If tail rotor pitch becomes fixed during decreased power situations (right pedal applied), the nose of the helicopter will turn to the right when power is applied, possibly even greater than complete loss of tail rotor thrust. Some conditions may require entry into autorotation to control yaw rate. If continued flight is possible, a shallow approach at about 80 KIAS to a roll-on landing should be made. As the touchdown point is approached, a mild deceleration should be executed at about 15 to 25 feet to reduce airspeed to about 40 KIAS. As collective is increased to cushion touchdown, the nose of the helicopter will turn to the right. Careful adjustment of collective and deceleration should allow a tail-low touchdown with approximate runway alignment. Upon

TM 1-1520-237-10

touchdown, lower collective carefully and use brakes to control heading.

- c. If tail rotor pitch becomes fixed during increased power situations (left pedal applied), the nose of the helicopter will turn left when collective is decreased. Under these conditions, powered flight to a prepared landing site and a powered landing is possible since the sideslip angle will probably be corrected when power is applied for touchdown. Adjust approach speed and rate of descent to maintain a sideslip angle of less than 20°. Sideslip angle may be reduced by either increasing airspeed or collective. Execute a decelerated touchdown tailwheel first, and cushion landing with collective. Upon touchdown, lower collective carefully and use brakes to control heading.

6. LAND AS SOON AS PRACTICABLE.

9.22.6 #1 TAIL RTR SERVO Caution Light On and BACK-UP PUMP ON Advisory Light Off or #2 TAIL RTR SERVO ON Advisory Light Off. Automatic switch-over did not take place.

- ①. **TAIL SERVO** switch - **BACKUP.**
- ②. **BACKUP HYD PUMP** switch - **ON.**
3. LAND AS SOON AS PRACTICABLE.

9.22.7 MAIN XMSN OIL PRESS Caution Light On/ XMSN OIL PRESS LOW/XMSN OIL TEMP HIGH or XMSN OIL TEMP Caution Light On. Loss of cooling oil supply will lead to electrical and/or mechanical failure of main generators. If the malfunction is such that oil pressure decays slowly, the generators may fail before **MAIN XMSN OIL PRESS** caution light goes on.

1. LAND AS SOON AS POSSIBLE.

If time permits:

2. Slow to 80 KIAS.
- ③. EMER APU START.
- ④. **GENERATORS NO. 1** and **NO. 2** switches - **OFF.**

9.22.8 CHIP INPUT MDL LH or RH Caution Light On.

- ①. ENG POWER CONT lever on affected engine - **IDLE.**
2. LAND AS SOON AS POSSIBLE.

9.22.9 CHIP MAIN MDL SUMP, CHIP ACCESS MDL LH or RH, CHIP TAIL XMSN or CHIP INT XMSN/ TAIL XMSN OIL TEMP or INT XMSN OIL TEMP Caution Light On.

LAND AS SOON AS POSSIBLE.

9.23 FIRE.

WARNING

If AC electrical power is not available, only the reserve fire bottle can be discharged and fire extinguishing capability for the #2 engine will be lost.

The safety of helicopter occupants is the primary consideration when a fire occurs; therefore, it is imperative that every effort be made to extinguish the fire. On the ground, it is essential that the engine be shut down, crew and passengers evacuated, and fire fighting begun immediately. If time permits, a "May Day" radio call should be made before the electrical power is OFF to expedite assistance from fire-fighting equipment and personnel. If the helicopter is airborne when a fire occurs, the most important single action that can be taken by the pilot is to land. Consideration must be given to jettisoning external stores and turning **FUEL BOOST PUMPS** and **XFER PUMPS** off prior to landing.

9.23.1 Engine/Fuselage Fire On Ground.

- ①. ENG POWER CONT levers - **OFF.**
- ②. ENG EMER OFF handle - Pull if applicable.
- ③. FIRE EXTGH switch - **MAIN/RESERVE**, as required.

9.23.2 APU Compartment Fire.

1. APU fire T-handle - Pull.
2. FIRE EXTGH switch - **MAIN/RESERVE** as required.

9.23.3 APU OIL TEMP HI Caution Light On.

APU CONTR switch - **OFF**. Do not attempt restart until oil level has been checked.

9.23.4 Engine Fire In Flight.**WARNING**

Attempt to visually confirm fire before engine shutdown or discharging extinguishing agent.

1. ENG POWER CONT lever (affected engine) - OFF.
2. ENG EMER OFF handle - Pull.
3. FIRE EXTGH switch - MAIN/RESERVE as required.
4. LAND AS SOON AS POSSIBLE.

9.23.5 Electrical Fire In Flight. Prior to shutting off all electrical power, the pilot must consider the equipment that is essential to a particular flight environment which will be affected, e.g., flight instruments, flight controls, etc. If a landing cannot be made as soon as possible the affected circuit may be isolated by selectively turning off electrical equipment and/or pulling circuit breakers.

1. BATT and GENERATORS switches - OFF.
2. LAND AS SOON AS POSSIBLE.

9.24 SMOKE AND FUME ELIMINATION.**WARNING**

If battery overheats, do not remove battery cover or attempt to disconnect or remove battery. Battery fluid will cause burns, and an overheated battery could cause thermal burns and may explode.

Smoke or fumes in the cockpit/cabin can be eliminated as follows:

1. Airspeed - 80 KIAS or less.
2. Cabin doors and gunner's windows - Open.

3. Place helicopter out of trim.

4. LAND AS SOON AS PRACTICABLE.

9.25 FUEL SYSTEM.**9.25.1 #1 or #2 FUEL FLTR BYPASS Caution Light On.**

1. ENG FUEL SYS selector on affected engine - XFD.
2. LAND AS SOON AS PRACTICABLE.

9.25.2 #1 and #2 FUEL FLTR BYPASS Caution Lights On.

LAND AS SOON AS POSSIBLE.

9.25.3 #1 FUEL LOW and #2 FUEL LOW Caution Lights On.

LAND AS SOON AS PRACTICABLE.

9.25.4 #1 or #2 FUEL PRESS Caution Light On.

a. If the light illuminates, flameout is possible. Do not make rapid collective movements. This emergency procedure has been written to include corrective action for critical situations. Critical situations are those where the loss of an engine represents a greater hazard than the possibility of pressurizing a fuel leak.

If the light illuminates and the situation is critical:

1. FUEL BOOST PUMP CONTROL switches - NO. 1 PUMP and NO. 2 PUMP - ON.
2. LAND AS SOON AS PRACTICABLE.

b. This portion of the emergency procedure has been written to provide the best method of isolating the cause of the failure and prescribing the proper corrective action when the situation is not critical. This portion of the emergency procedure assumes the **FUEL BOOST PUMP CONTROL** switches are **OFF** when the malfunction occurs.

If the situation is not critical:

1. ENG FUEL SYS selector on affected engine - XFD.

If light stays on:

TM 1-1520-237-10

- ② FUEL BOOST PUMP CONTROL switches - NO. 1 PUMP and NO. 2 PUMP - ON.

If light stays on:

- ③ FUEL BOOST PUMP CONTROL switches - NO. 1 PUMP and NO. 2 PUMP - OFF.

4. LAND AS SOON AS PRACTICABLE.

9.26 ELECTRICAL SYSTEM.

9.26.1 #1 and #2 Generator Failure (#1 and #2 CONV and AC ESS BUS OFF Caution Lights On).

- ① SAS 1 switch - Press off.
2. Airspeed - Adjust (80 KIAS or less).
- ③ GENERATORS NO. 1 and NO. 2 switches - RESET ; then ON.

If caution lights remain on:

- ④ GENERATORS NO. 1 and NO. 2 switches - OFF.
- ⑤ EMER APU START.
- ⑥ SAS 1 switch - ON.
7. LAND AS SOON AS PRACTICABLE.

9.26.2 #1 or #2 GEN Caution Light On.

CAUTION

When the #1 ac generator is failed, and the backup pump circuit breaker is out, turn off ac electrical power before resetting the backup pump power circuit breaker, to avoid damaging the current limiters.

- ① Affected GENERATORS switch - RESET ; then ON.

If caution light remains on:

- ② Affected GENERATORS switch - OFF.

9.26.3 #1 and #2 CONV Caution Lights On.

- ① Unnecessary dc electrical equipment - OFF.

NOTE

When only battery power is available, NICAD battery life is about 22 minutes day and 14 minutes night for a battery 80% charged. SLAB battery life is about 38 minutes day and 24 minutes night for a battery 80% charged.

2. LAND AS SOON AS PRACTICABLE.

9.26.4 BATTERY FAULT Caution Light On.

- ① BATT switch - OFF ; then ON. If BATTERY FAULT caution light goes on, cycle BATT switch no more than two times.

If light remains on:

- ② BATT switch - OFF.

9.26.5 BATT LOW CHARGE Caution Light On.

If light goes on after AC power is applied:

- ① BATT switch - OFF; then ON. About 30 minutes may be required to recharge battery.

If light goes on in flight:

- ② BATT switch - OFF, to conserve remaining battery charge.

9.27 HYDRAULIC SYSTEM.

9.27.1 #1 HYD PUMP Caution Light On.

- ① TAIL SERVO switch - BACKUP ; then NORMAL.
2. LAND AS SOON AS PRACTICABLE.

9.27.2 #2 HYD PUMP Caution Light On.

- ① POWER ON RESET switches - Simultaneously press, then release.

2. LAND AS SOON AS PRACTICABLE.

9.27.3 #1 and #2 HYD PUMP Caution Lights On.

LAND AS SOON AS POSSIBLE. Restrict control movement to moderate rates.

9.27.4 #1 or #2 HYD PUMP Caution Light On and BACK-UP PUMP ON Advisory Light Off. Loss of both the No. 1 hydraulic pump and backup pump results in both stages of the tail-rotor servo being unpressurized. The yaw boost servo is still pressurized and the mechanical control system is still intact allowing limited tail-rotor control. Because of the limited yaw control range available, a roll-on landing 40 KIAS or above is required. Loss of both the No. 2 hydraulic pump and the backup pump results in the loss of pilot-assist servos.

1. Airspeed - Adjust to a comfortable airspeed.

2. BACKUP HYD PUMP switch - ON.

If **BACK-UP PUMP ON** advisory light remains off:

3. FPS and BOOST switches - Off (for #2 HYD PUMP caution light).

4. LAND AS SOON AS POSSIBLE.

9.27.5 #1 or #2 PRI SERVO PRESS Caution Light On. Illumination of #1 or #2 **PRI SERVO PRESS** caution light can be caused by inadvertently placing the **SVO OFF** switch on either collective control head in **1ST STG** or **2ND STG** position. Before initiating emergency procedure action, the pilots should check that both **SVO OFF** switches are centered.

LAND AS SOON AS POSSIBLE.

9.27.6 #1 RSVR LOW and #1 HYD PUMP Caution Lights On With BACK-UP PUMP ON Advisory Light On.

1. LAND AS SOON AS PRACTICABLE.

If the **BACK-UP RSVR LOW** caution light also goes on:

2. SVO OFF switch - 1ST STG.

WARNING

If #2 **PRI SERVO PRESS** caution light goes on, establish landing attitude, minimize control inputs and begin a descent.

3. LAND AS SOON AS POSSIBLE.

9.27.7 #2 RSVR LOW and #2 HYD PUMP Caution Lights On With BACK-UP PUMP ON Advisory Light On.

1. **POWER ON RESET** switches - Simultaneously press then release.

2. LAND AS SOON AS PRACTICABLE.

If **BACK-UP RSVR LOW** caution light also goes on:

3. SVO OFF switch - 2ND STG.

WARNING

If #1 **PRI SERVO PRESS** caution light goes on, establish landing attitude, minimize control inputs, and begin a descent.

4. LAND AS SOON AS POSSIBLE.

9.27.8 #2 RSVR LOW Caution Light On.

Pilot assist servos will be isolated; if they remain isolated, proceed as follows:

1. **BOOST** and **FPS** switches - Off.

2. LAND AS SOON AS PRACTICABLE.

NOTE

Because the logic module will close valves supplying pressure to the pilot-assist servos, **BOOST SERVO OFF**, **SAS OFF**, and **TRIM FAIL** caution lights will be on.

9.27.9 Collective Boost Servo Hardover/Power Piston Failure. Hardover failure of the collective boost servo will increase control forces (as much as 150 pounds)

TM 1-1520-237-10

in the collective. The increased control forces can be immediately eliminated by shutting off the boost servo. Resulting control loads will be the same as for in-flight boost servo off.

①. **BOOST** switch - Off.

2. LAND AS SOON AS PRACTICABLE.

9.27.10 Pitch Boost Servo Hardover. Hardover failure of the pitch boost servo will increase the longitudinal cyclic control forces (approximately 20 pounds). The increased control forces can be immediately eliminated by shutting off SAS.

①. **SAS** (1 and 2) and **FPS** switches - Off.

2. LAND AS SOON AS PRACTICABLE.

9.27.11 BOOST SERVO OFF Caution Light On. Lighting of the **BOOST SERVO OFF** caution light with no other caution lights on indicates a pilot valve jam in either the collective or yaw boost servo. Control forces in the affected axis will be similar to flight with boost off.

①. **BOOST** switch - Off.

2. LAND AS SOON AS PRACTICABLE.

9.28 LANDING AND DITCHING.

9.28.1 Emergency Landing In Wooded Areas. Power Off.

1. AUTOROTATE. Decelerate helicopter to stop all forward speed at treetop level.
2. Collective adjust to maximum before main rotor contacts tree branches.

9.28.2 Ditching - Power On. The decision to ditch the helicopter shall be made by the pilot when an emergency makes further flight unsafe.

1. Approach to a hover.
2. Cockpit doors jettison and cabin doors open prior to entering water.
3. Pilot shoulder harness - Lock.
4. Survival gear - Deploy.

5. Personnel, except pilot, exit helicopter.

6. Fly helicopter downwind a safe distance and hover.

7. **ENG POWER CONT** levers - **OFF**.

8. Perform hovering autorotation, apply full collective to decay rotor RPM as helicopter settles.

9. Position cyclic in direction of roll.

10. Exit when main rotor has stopped.

9.28.3 Ditching - Power Off. If ditching is imminent, accomplish engine malfunction emergency procedures. During descent, open cockpit and cabin doors. Decelerate to zero forward speed as the helicopter nears the water. Apply full collective as the helicopter nears the water. Maintain a level attitude as the helicopter sinks and until it begins to roll; then apply cyclic in the direction of the roll. Exit when the main rotor is stopped.

1. AUTOROTATE.

2. Cockpit doors jettison and cabin doors open prior to entering water.

3. Cyclic - Position in direction of roll.

4. Exit when main rotor has stopped.

9.29 FLIGHT CONTROL/MAIN-ROTOR SYSTEM MALFUNCTIONS.

a. Failure of components within the flight control system may be indicated through varying degrees of feedback, binding, resistance, or sloppiness. These conditions should not be mistaken for malfunction of the AFCS.

b. Failure of a main rotor component may be indicated by the sudden onset or steady increase in main rotor vibration or unusual noise. Severe changes in lift characteristics and/or balance condition can occur due to blade strikes, skin separation, shift or loss of balance weights or other material. Malfunctions may result in severe main rotor flapping. The severity of vibrations may be minimized by reducing airspeed.

If the main rotor system malfunctions:

WARNING

Danger exists that the main rotor system could collapse or separate from the aircraft after landing. Exit when main rotor has stopped.

1. LAND AS SOON AS POSSIBLE.
2. EMER ENG(S) SHUTDOWN after landing.

9.29.1 SAS Failure With No Failure/Advisory Indication. Erratic electrical input to a SAS actuator can result in moderate rotor tip path oscillations that are often

accompanied with pounding sounds or "knocking" which may be felt in the cyclic or pedal controls. No SAS malfunction, however, can physically drive the pilots' flight controls. Failure of **SAS 2** is usually but not necessarily followed by a failure/advisory indication. Failure of a **SAS 1** component will not be accompanied by a failure/advisory indication as **SAS 1** does not contain diagnostic capabilities.

If the helicopter experiences erratic motion of the rotor tip path without failure/advisory indication:

- ①. SAS 1 switch - Off.

If condition persists:

- ②. SAS 1 switch - ON.

- ③. SAS 2 switch - Off.

If malfunction still persists:

- ④. SAS 1 and FPS switches - Off.

9.29.2 SAS 2 Failure Advisory Light On.

POWER ON RESET switches - Simultaneously press and then release.

9.29.3 SAS OFF Caution Light On.

FPS switch - Off.

9.29.4 FLT PATH STAB Caution Light On.

a. An FPS malfunction will be detected by the SAS/FPS computer, which will disengage FPS function in the applicable axis and light the **FLT PATH STAB** caution light and corresponding **FAILURE ADVISORY** light.

b. **EH** With the Mode Select Panel switch in the **IINS/IINS** position, a failure of the IINS gyro will cause a failure of the FPS and may possibly cause **FPS/SAS 2** to become erratic in roll motion. In addition to the failure indications on the IINS Control Display screen, the **GYRO** segment on the Failure Advisory Panel will illuminate. The copilot's VSI will fail with a **ATT** warning flag and both HSI's will fail with **HDG** warning flags. The aircraft may drift in pitch, roll and/or yaw axis due to FPS failure.

- ①. **EH** **SYSTEMS SELECT - DG/VG**.
- ②. **POWER ON RESET** switches - Simultaneously press and then release.

If failure returns, control affected axis manually.

WARNING

If the airspeed fault advisory light is illuminated, continued flight above 70 KIAS with the stabilator in the AUTO MODE is unsafe since a loss of the airspeed signal from the remaining airspeed sensor would result in the stabilator slewing full-down.

If the airspeed fault light remains illuminated on the AFCS panel:

NOTE

Use of the cyclic mounted stabilator slew-up switch should be announced to the crew to minimize cockpit confusion.

3. Manually slew stabilator - Adjust to 0° if above 40 KIAS. The preferred method of manually slewing the stabilator up is to use the cyclic mounted stabilator slew-up switch.

4. LAND AS SOON AS PRACTICABLE.

9.29.5 Pitch, Roll or Yaw/Trim Hardover.

a. A pitch FPS/trim hardover will cause a change in pitch attitude and a corresponding longitudinal cyclic movement of about 1/2 inch. This condition will be detected by the SAS/FPS computer which will disengage FPS and trim functions in the pitch axis and light the **FLT PATH STAB** and **TRIM FAIL** caution lights.

b. A roll FPS/trim hardover will be characterized by a 1/2 inch lateral stick displacement, resulting in a corresponding roll rate and a constant heading sideslip condition, caused by the yaw FPS attempting to maintain heading. The SAS/FPS computer will detect the hardover condition and disengage lateral trim and illuminate the **FLT PATH STAB** and **TRIM FAIL** caution lights.

c. A yaw FPS/trim hardover is characterized by an improper motion of the pedals, resulting in about 1/4 inch of pedal motion followed by a corresponding change in helicopter heading trim. This condition will be detected by the SAS/FPS computer, which will disengage trim and FPS functions in the yaw axis and light the **FLT PATH STAB** and **TRIM FAIL** caution lights.

If failure occurs:

POWER ON RESET switches - Simultaneously press and then release.

If failure returns, control affected axis manually.

9.29.6 Trim Actuator Jammed. Both yaw and roll trim actuators incorporate slip clutches to allow pilot and copilot inputs if either actuator should jam. The forces required to override the clutches are 80 pounds maximum in yaw and 13 pounds maximum in roll.

TM 1-1520-237-10

LAND AS SOON AS PRACTICABLE.

9.30 STABILATOR MALFUNCTION - AUTO MODE FAILURE.

An Auto Mode Failure will normally result in the stabilator failing in place. The indications to the pilots of the failure are a beeping audio warning, and **MASTER CAUTION** and **STABILATOR** caution lights illuminating when the automatic mode fails. The position of failure may vary from the ideal programmed position by 10° at 30 KIAS to 4° at 150 KIAS. If an approach is made with the stabilator fixed 0°, the pitch attitude may be 4° to 5° higher than normal in the 20 to 40 KIAS range.

WARNING

If acceleration is continued or collective is decreased with the stabilator in a trailing edge down position, longitudinal control will be lost. The stabilator shall be slewed to 0° above 40 KIAS and full-down when airspeed is less than 40 KIAS.

Pressing the **AUTO CONTROL RESET** button after a failure occurs results in the automatic mode coming on for one second. If a hardover signal to one actuator is present, the stabilator could move approximately 4° to 5° in that one second before another auto mode failure occurs. Subsequent reset attempts could result in the stabilator moving to an unsafe position.

If the stabilator **AUTO mode** repeatedly disengages during a flight, flight above 70 KIAS is prohibited with the stabilator in **AUTO mode**.

If an **AUTO Mode Failure** Occurs:

NOTE

Use of cyclic mounted stabilator slew-up switch should be announced to the crew to minimize cockpit confusion.

1. Cyclic mounted stabilator slew-up switch - Adjust if necessary to arrest nose down pitch rate.
2. AUTO CONTROL switch - Press ON once.

If automatic control is not regained:

3. Manually slew stabilator - Adjust to 0° for flight above 40 KIAS or full down when airspeed is below 40 KIAS. The preferred method of manually slewing the stabilator up is to use the cyclic mounted stabilator slew-up switch.

4. LAND AS SOON AS PRACTICABLE.

If manual control is not possible:

5. **STAB POS** indicator - Check and fly at or below **KIAS LIMITS** shown on placard.

6. LAND AS SOON AS PRACTICABLE.

9.31 UNCOMMANDED NOSE DOWN/UP PITCH ATTITUDE CHANGE.

a. An uncommanded nose down/up pitch attitude change could be the result of a stabilator or other AFCS malfunction (SAS or FPS). There is a remote possibility that a stabilator malfunction could occur in the automatic or manual mode without audio warning or caution light illumination.

b. If an uncommanded nose down pitch attitude change is detected, the pilot should initially attempt to stop the rate with aft cyclic. Maintaining or increasing collective position may assist in correcting for a nose down pitch attitude. If the nose down pitch rate continues, and/or inappropriate stabilator movement is observed, activate the cyclic mounted stabilator slew-up switch to adjust the stabilator to control pitch attitude. Continue to monitor the stabilator position when the cyclic mounted stabilator slew-up switch is released to ensure movement stops.

c. Uncommanded nose up pitch attitude changes at airspeeds of 140 KIAS and less should not become severe even if caused by full up slew of the stabilator and can be corrected with forward cyclic. If the nose up pitch attitude is caused by full up stabilator slew at airspeeds above 140 KIAS, full forward cyclic may not arrest the nose up pitch rate.

d. If an uncommanded nose up pitch attitude change is detected, the pilot should initially attempt to stop the rate with forward cyclic. At airspeeds above 140 KIAS, a collective reduction of approximately 3 inches, simultaneously with forward cyclic will arrest the nose up pitch rate. If these control corrections are delayed and/or a large nose up attitude results, a moderate roll to the nearest horizon will assist in returning the aircraft to level flight. After the nose

returns to the horizon, roll to a level attitude. After coordination with the pilot, the copilot should adjust the stabilator to 0° at airspeeds above 40 KIAS and full down at airspeeds below 40 KIAS.

If an uncommanded nose down pitch attitude occurs:

1. Cyclic - Adjust as required.
2. Collective - Maintain or increase.
3. Cyclic mounted stabilator slew-up switch - Adjust as required to arrest nose down pitch rate.
- ④. **MAN SLEW** switch - Adjust to 0° at airspeeds above 40 KIAS and full down at airspeeds below 40 KIAS.

5. LAND AS SOON AS PRACTICABLE.

If an uncommanded nose up pitch attitude occurs:

1. Cyclic - Adjust as required.
2. Collective - Reduce as required.
- ③. **MAN SLEW** switch - Adjust to 0° at airspeeds above 40 KIAS and full down at airspeeds below 40 KIAS.
4. LAND AS SOON AS PRACTICABLE.

Section II MISSION EQUIPMENT

9.32 EMERGENCY JETTISONING.

When conditions exist which require the jettisoning of external loads to ensure continued flight or execution of emergency procedures, the crew should jettison the load as follows:

CARGO REL or HOOK EMER REL button
- Press.

9.33 EMERGENCY RELEASE OF RESCUE HOIST LOAD.

If the rescue hoist becomes jammed, inoperative, or the cable is entangled and emergency release is required:

■ To cut cable from cockpit:

1. CABLE SHEAR switch - **FIRE**.

■ To cut cable from hoist operator's position:

2. CABLE CUT switch - **FIRE**.

9.34 BLADE DEICE SYSTEM MALFUNCTIONS.

9.34.1 MR DE-ICE FAULT or MR DE-ICE FAIL, or TR DE-ICE FAIL Caution Light On.

a. If the **MR DE-ICE FAULT** caution light goes on, the system will continue to function in a degraded mode. The pilot must be aware of vibration levels and % TRQ requirements, which could be a result of ice buildup.

b. If the **MR DE-ICE FAIL** caution light goes on, the main rotor deice will automatically turn off. Tail rotor deice will remain on.

c. If the **TR DE-ICE FAIL** caution light goes on, tail rotor deice will automatically turn off. Main rotor deice will remain on.

1. Icing conditions - Exit.

2. **BLADE DEICE POWER** switch - **OFF**, when out of icing conditions.

If vibrations increase:

3. LAND AS SOON AS POSSIBLE.

9.34.2 PWR MAIN RTR and/or TAIL RTR MONITOR Light On.

If a **PWR** monitor light is on with **BLADE DEICE POWER** switch **ON** to stop power from being applied to blades:

1. Icing conditions - **EXIT**.

2. **BLADE DEICE POWER** switch - **OFF**.

If a **PWR** monitor light is still on with **BLADE DEICE POWER** switch **OFF**:

3. **GENERATORS NO. 1 or NO. 2** switch - **OFF**.

4. **APU** generator switch - **OFF** (if in use).

5. LAND AS SOON AS PRACTICABLE.

9.34.3 Ice Rate Meter Fail or Inaccurate. Failure of the ice rate meter should be indicated by appearance of the **FAIL** flag on the meter face. Inaccuracy of the meter will be indicated by increased torque required and/or increase of vibration levels due to ice buildup. If failure or inaccuracy is suspected, with no other indicated failures, the system can be manually controlled.

1. **BLADE DEICE MODE** switch - **MANUAL** as required.

If vibration levels increase or % TRQ required increases:

2. Higher icing **MODE** - Select as required.

If ice buildup continues:

3. LAND AS SOON AS PRACTICABLE.

9.34.4 Loss of NO. 1 or NO. 2 Generator During Blade Deice Operation. Loss of one generator during blade deice operation will result in loss of power to the system. To restore system operation, the **APU** must be started and the **APU** generator switch **ON**. The **APU GEN ON** advisory light will not go on because one main generator is still operating. The **APU** generator will supply power only for blade deice operation.

Pilot not on the controls:

EMER APU START.**9.35 EXTERNAL EXTENDED RANGE FUEL SYSTEM FAILURE TO TRANSFER SYMMETRICALLY IN MANUAL MODE. ERFS**

a. Total failure of a single external extended range fuel system tank to transfer fuel could be the result of a loose filler cap, bleed-air regulator/shutoff valve, fuel shutoff valve, or line blockage failure.

b. Total failure of one tank to transfer fuel will turn on the associated tank's **NO FLOW** light. Reduced flow from one tank may not cause a **NO FLOW** light to go on, but will change the lateral CG of the helicopter. The pilot will notice a migration of the lateral cyclic stick position as the lateral CG offset from neutral increases. For example, a fully asymmetric outboard 230-gallon tank set (one tank full, one tank empty), on an otherwise neutrally balanced H-60, will result in a level flight lateral stick position offset of approximately two inches. If asymmetric transfer is suspected, stop transfer on the selected tank set and initiate transfer on the other tank set, if installed.

If asymmetric fuel transfer is suspected:

1. Stop transfer on tank set.
2. Select other tank set and initiate transfer.
3. LAND AS SOON AS PRACTICABLE.

WARNING

With asymmetric fuel loading, lateral control margin will be reduced in the direction opposite the heavy side. The aircraft has been flown from hover to 138 KIAS, with lateral CG's equivalent to a fully asymmetric outboard 230-gallon tank set, (full right tank, no stores on left side). The most critical maneuvers are turns toward the heavy side and approaches with a crosswind from the lighter side. These maneuvers are not recommended. The most adverse condition for lateral controllability is right side heavy, in the 20 to 50 KIAS range. Do not exceed 30 degree angle of bank. If controllability is in question, jettison the asymmetric tank set.

Should controlled flight with one heavy external tank become necessary, proceed as follows:

1. Make all turns shallow (up to standard rate), and in the direction away from heavy side (particularly when a right tank remains full).
2. Avoid abrupt control motions, especially lateral cyclic.
3. If possible, shift personnel to the light side of the helicopter.
4. Select a suitable roll-on landing area, and make a roll-on landing with touchdown speed in excess of 30 KIAS. To increase control margin, execute the approach into the wind or with a front quartering wind from the heavy side and align the longitudinal axis of the aircraft with the ground track upon commencing the approach. If a suitable roll-on landing area is not available, make an approach to a hover into the wind, or with a front quartering wind from the heavy side.

9.35A AUXILIARY FUEL MANAGEMENT SYSTEM FAILURE TO TRANSFER SYMMETRICALLY IN MANUAL MODE. AFMS

a. Total failure of a single external extended range fuel system tank to transfer fuel could be the result of a loose filler cap, bleed-air regulator/shutoff valve, fuel shutoff valve, or line blockage failure.

b. Total failure of one tank to transfer fuel will turn on the associated tank's **NO FLOW** light. Reduced flow from one tank may not cause a **NO FLOW** light to go on, but will result in a lateral imbalance between tank pairs whether **AUTO** or **MAN** mode is selected. Occasional monitoring of the auxiliary fuel management panel (AFMP) fuel quantity displays provides the crew an accurate means of identifying a developing imbalance condition.

When an asymmetric fuel condition (greater than 400 pound difference between external tank pairs) is identified:

1. **XFER MODE** switch - **MAN**.

CAUTION

Monitor fuel transfer to remain within CG limits and avoid asymmetric loading.

2. **MAN XFER** switch - Select heavy tank **LEFT** or **RIGHT** until imbalance condition is cor-

rected. If the imbalance condition cannot be corrected:

3. **XFER MODE** switch - **OFF**.
4. **LAND AS SOON AS PRACTICABLE**.

WARNING

With asymmetric fuel loading, lateral control margin will be reduced in the direction opposite the heavy side. The aircraft has been flown from hover to 138 KIAS, with lateral CG's equivalent to a fully asymmetric outboard 230-gallon tank set, (full right tank, no stores on left side). The most critical maneuvers are turns toward the heavy side and approaches with a crosswind from the lighter side. These maneuvers are not recommended. The most adverse condition for lateral controllability is right side heavy, in the 20 to 50 KIAS range. Do not exceed 30 degree angle of bank. If controllability is in question, jettison the asymmetric tank set.

Should controlled flight with one heavy external tank become necessary, proceed as follows:

1. Make all turns shallow (up to standard rate), and in the direction away from heavy side (particularly when a right tank remains full).
2. Avoid abrupt control motions, especially lateral cyclic.
3. If possible, shift personnel to the light side of the helicopter.
4. Select a suitable roll-on landing area, and make a roll-on landing with touchdown speed in excess of 30 KIAS. To increase control margin, execute the approach into the wind or with a front quartering wind from the heavy side and align the longitudinal axis of the aircraft with the ground track upon commencing the approach. If a suitable roll-on landing area is not available, make an approach to a hover into the wind, or with a front quartering wind from the heavy side.

9.36 EXTERNAL STORES JETTISON. ES

At high gross weights and with one engine inoperative, or in an emergency or performance limited situation, it may be necessary to jettison a tank set. Circuitry prevents the release of any individual tank even if a single tank jettison has been selected at the **STORES JETTISON** control panel. The helicopter will remain controllable even if a single tank fails to release because of a malfunction in the jettison system. In the case of a four tank configuration, and depending on the amount of fuel in the tanks, lateral control may be lost if both tanks on one side fail to release. For this reason the use of the **EMER JETT ALL**, or **JETT ALL** switches is not recommended. Only in circumstances where failure to do so would result in certain damage to aircraft and crew, should the use of these switches be considered, at the discretion of the pilot in command.

If jettisoning of tanks is required:

- ①. **STORES JETTISON** switch - Select **INBD BOTH, OUTBD BOTH** or **ALL** as applicable.
- ②. **JETT** switch - Actuate.

If primary jettison system does not operate:

- ③. **EMER JETT ALL** switch - Actuate.

9.37 FUEL FUMES IN COCKPIT/CABIN WITH EXTERNAL EXTENDED RANGE FUEL SYSTEM PRESSURIZED. ERFS

If the bleed air check valve(s) is stuck in the open position when the heater is turned on, the resulting bleed air manifold pressure drops due to the heater bleed air demands. This allows fumes/mist above the tanks to backflow through the bleed air manifold, through the heater, and into the cabin. If fuel fumes or mist are noted during external extended range fuel system operation, perform the following:

If heater is on:

- ①. **HEATER** switch - **OFF**.

If heater is off or fumes persist:

- ②. **PRESS OUTBD** and **INBD** switches - **OFF**
- ③. **MODE** switch - **OFF**.

- ④. **FUEL BOOST PUMP CONTROL** switches -
As required.

9.38 FUEL FUMES IN COCKPIT/CABIN WITH EXTERNAL EXTENDED RANGE FUEL SYSTEM PRESSURIZED. AFMS

If the bleed air check valve(s) is stuck in the open position when the heater is turned on, the resulting bleed air manifold pressure drops due to the heater bleed air demands. This allows fumes/mist above the tanks to backflow through the bleed air manifold, through the heater, and into the cabin. If fuel fumes or mist are noted during external extended range fuel system operation, perform the following:

If heater is on:

- ①. **HEATER** switch - **OFF**.

If heater is off or fumes persist:

- ②. **PRESS** switch - **OFF**.

- ③. **XFER MODE** switch - **OFF**.

- ④. **FUEL BOOST PUMP CONTROL** switches -
As required.

9.39 VOL LAUNCHER RACKS JETTISON.

At high gross weights and with one engine inoperative or in an emergency, it may be necessary to jettison the volcano launcher racks. Both lower launcher racks must separate from helicopter before upper racks are activated. If one lower rack remains, upper racks will not jettison.

If jettisoning of launcher rack is required:

1. **JETTISON** switch - **JETTISON**.

If jettison procedure above fails, do the following immediately:

2. **EMER JETTISON** switch - **JETTISON**.

APPENDIX A

REFERENCES

AR 70-50	Designating and Naming Military Aircraft, Rockets and Guided Missiles
AR 95-1	Army Aviation General Provisions and Flight Regulations
AR 95-3	General Provisioning, Training, Standardization, and Resource Management
AR 385-40	Accident Reporting and Records
DA PAM 40-501	Noise and Conservation of Hearing
DA PAM 738-751	Functional Users Manual for the Army Maintenance Management System Aviation (TAMMS-A)
DOD FLIP	Flight Information Publication
FAR Part 91	Federal Air Regulation, General Operating and Flight Rules
FM 1-202	Environmental Flight
FM 1-203	Fundamentals of Flight
FM 1-230	Meteorology for Army Aviators
FM 1-240	Instrument Flying and Navigation for Army Aviators
FM 10-68-1	Aircraft Refueling
FM 55-450-1	Army Helicopter External Load Operations
FM 55-450-2	Army Helicopter Internal Load Operations
TB 55-9150-200-24	Engine and Transmission Oils, Fuels, and Additives for Army Aircraft
TC 1-204	Night Flight Techniques and Procedures
TM 1-1520-237-CL	Operator's and Crewmember's Checklist, Army Model UH-60A, UH-60L and EH-60A Helicopters
TM 1-1520-250-23	General Tie-down and Mooring Technical Manual Aviation Unit and Intermediate Maintenance. All Series Army Models AH-64, UH-60, CH-47, UH-1, AH-1, OH-58 Helicopters.
TM 9-1005-224-10	Operator's Manual M60 Machinegun
TM 9-1300-206	Ammunition and Explosives
TM 11-5810-262-10	Operator's Manual for Communication Security Equipment TSEC/KY 58
TM 11-5841-281-12	Operator's Manual for Doppler Navigation Set
TM 11-5841-283-12	Operator's Manual for AN/APR 39(V) Radar Signal Detecting Set
TM 11-5865-200-12	AN/ALQ 144 Countermeasure Set
TM 11-5895-1199-12	Operator's and Organization Maintenance for MARK-12 IFF System AN/APX-100, AN/APX-72

APPENDIX A (Cont)

TM 11-5895-1037-12 & P	Transponder Set AN/APX-100(V)
TM 55-1500-342-23	Army Aviation Maintenance Engineering Manual: Weight and Balance
TM 750-244-1-5	Procedures for the Destruction of Aircraft and Associated Equipment to Prevent Enemy Use

APPENDIX B

ABBREVIATIONS AND TERMS

AFMP	- auxiliary fuel management panel	ECU	- electrical control unit
AFMS	- auxiliary fuel management system	EMB	- expanded memory board
AJ	- anti-jam	ENG	- engine
ALT	- altitude	EOT	- element-on-time
ANT	- antenna	ERFS	- extended range fuel system
APU	- auxiliary power unit	ESU	- electronic sequence unit
ATF	- aircraft torque factor	ESSS	- external stores support system
BL	- butt line	ETF	- engine torque factor
°C	- degree Celsius	ETL	- effective translational lift
CBIT	- continuous built in test	°F	- degree Fahrenheit
CCU	- converter control unit	FAT	- free-air temperature
CDU	- central display unit	FPM	- feet-per-minute
CG	- center of gravity	ft	- feet
CL	- center line	GPS	- global positioning system
CRT	- cathode ray tube	GW	- gross weight
CW	- continuous wave	HAT	- height above terrain
DCU	- dispenser control unit	HMU	- hydromechanical unit (fuel control)
DEC	- digital electronic control (for engine)	HQ	- have quick
DEG	- degree	hr	- hour
DF	- direction find	HSI	- horizontal situation indicator
DRVS	- Doppler radar velocity sensor	HSP	- hot start preventor
DU	- display unit	HSS	- horizontal stores support
ECM	- electronic counter measure	HUD	- heads up display
EGR	- embedded GPS receiver	IAS	- indicated airspeed
ΔF	- change in flat plate drag area	IAW	- in accordance with
ΔTRQ	- change in torque	IB	- inboard
		IBIT	- initiated built in test

APPENDIX B (Cont)

IGE	- in ground effect	NVG	- night vision goggles
IINS	- integrated inertial navigation system	°	- degree
IN	- inch	% RPM R	- rotor rpm, percent
IN HG	- inch of mercury	% RPM 1 or 2	- No. 1 or No. 2 engine Np % rpm
IPS	- inlet particle separator - inches per second	OAT	- outside air temperature
IR	- infrared	OB	- outboard
IRCM	- infrared countermeasures	ODV	- overspeed and drain valve
KCAS	- knots calibrated airspeed	OEI	- one engine inoperative
KIAS	- knots indicated airspeed	OGE	- out of ground effect
KN	- knot	PA	- pressure altitude
KTAS	- knots true airspeed	PAS	- power available spindle
lb	- pound(s)	PBIT	- power up built in test
lb/gal	- pounds-per-gallon	PDU	- pilot display unit
lb/hr	- pounds-per-hour	POS	- position
LCD	- liquid crystal display	POU	- pressurizing and overspeed unit
LDI	- leak detection isolation	PRESS	- pressure
LDS	- load-demand spindle	PPM	- pounds-per-minute
LIM	- limit	PSCU	- power supply calibration unit
LLL	- low light level	PSI	- pounds per square inch
LRU	- line replaceable unit	PSID	- pounds per square inch differential
LWC	- liquid water content	PSIG	- pounds per square inch gauge
MAX	- maximum	R/C	- rate of climb
MGRS	- military grid reference system	R/D	- rate of descent
MIN	- minimum	RDW	- ram dump waypoints
min	- minutes	RPM	- revolutions-per-minute
Ng SPEED 1 or 2	- No. 1 or No. 2 engine compressor speed % rpm	RTA	- Receiver Transmitter Antenna
NM	- nautical miles	SDC	- signal data converter
Np	- power turbine speed		

APPENDIX B (Cont)

SEL	- select	Vh	- maximum level flight speed using torque available - 30 minutes
SL	- sea level		
SLAB	- sealed lead acid battery	VIDS	- vertical instrument display systems
SPEC	- specification		
STA	- station	Vne	- velocity never exceed (airspeed limitation)
STD TEMP	- 15°C at sea level		
SQ FT	- square feet	VSI	- vertical situation indicator
TAS	- true airspeed	VSP	- vertical support pylon
TGT	- turbine gas temperature	WL	- water line
TOD	- time of day	WOD	- word of day
% TRQ	- torque, percent	WOW	- weight-on-wheels
TRQ	- torque	XMSN	- transmission
UTM	- universal transverse mercator		
VDC	- volts direct current		

APPENDIX C

KY-100.

C.1 KY-100 CONFIGURATION SETUP.

CONTROL/ DISPLAY	FUNCTION
▲ and ▼	Used to scroll through the available menus or available options. ▼ scrolls in the opposite direction of the ▲. Pressing ▲ and ▼ simultaneously returns the display to the previous set of menus (one level up from the current menu on the display).
INIT	Used to bring up the set of menus or options that are one level below the current menu on the display.

C.1.1 KY-100 Audio/Data and Radio Interface Settings Procedure.

a. Audio Data Interface.

- (1) **PRESET** switch - **MAN**.
- (2) **MODE** switch - **OFL**.
- (3) ▲ - Repeatedly press until **INFC** is displayed.
- (4) **INIT** - Press, and **AUD-dATA** will be displayed (if necessary use ▲ or ▼ to display **AUD-dATA**).
- (5) **INIT** - Press.
- (6) Select the item that needs to be changed (Menu Item column of Table C-1) by repeatedly pressing ▲ until the item is displayed.
- (7) **INIT** - Press, and the default setting will be displayed.
- (8) If the setting does not agree with the setting shown under the Setting column of Table C-1, ▲ - Press until the proper setting is displayed.
- (9) ▲ and ▼ - Press simultaneously.

- (10) Repeat steps (6) through (9) until all of the menu items shown in Table C-1 have been set as indicated.
- (11) After all menu items from Table C-1 have been correctly set, ▲ and ▼ - Press simultaneously, and **AUD-dATA** will be displayed.
- (12) ▲ and ▼ - Press simultaneously, and **INFC** will be displayed. Proceed to step b. to set Radio Interface settings.

b. Radio Interface.

- (1) **PRESET** switch - **MAN**.
- (2) **MODE** switch - **OFL**.
- (3) ▲ - Repeatedly press until **INFC** is displayed.
- (4) **INIT** - Press, and **AUD-dATA** will be displayed.
- (5) ▲ or ▼ - Press until **RADIO** is displayed.
- (6) **INIT** - Press, and **NRW-bAND** will be displayed.
- (7) **INIT** - Press.
- (8) ▲ or ▼ - Press until **SET dEF** is displayed.
- (9) **INIT** - Press, and a flashing **SET dEF** will be displayed.
- (10) **INIT** - Press. **SET dEF** stops flashing and a pass tone is heard, indicating nrw-band radio default settings are stored in memory.
- (11) ▲ and ▼ - Press simultaneously.
- (12) Select the item that needs to be changed (Menu Item column of Table C-2) by repeatedly pressing ▲ or ▼ until the item is displayed.
- (13) **INIT** - Press, and the default setting or a Sub-Menu (if one exists) will be displayed. Unless Table C-2 indicates a SubMenu, go to step (15).

APPENDIX C (Cont)

Table C-1.

MENU ITEM	SETTING	DEFAULT
GUARd	GRd OFF	YES
MIC	MIC UNbAL	YES
bALANCE	RX UNbAL*	YES
IMPEd	150 OHMS	NO
dAT SENS	MARK +	YES
RX COUP	RX AC	YES
TX COUP	TX AC	YES
TX CLK	J2-V	NO

* For MH Series aircraft MIC should be set to MIC BAL.

(14) In cases with a SubMenu, select the appropriate SubMenu by pressing **▲** until the SubMenu indicated in Table C-2 is displayed. Then press **INIT**, and the default setting will be displayed. **▲** - Press until proper setting is displayed. **▲** and **▼** - Press simultaneously. Repeat this step for all SubMenus within the same Menu Item. When all SubMenu settings within the same Menu Item have been set, **▲** and **▼** - Press simultaneously.

(15) If the setting does not agree with the setting shown under the Setting column of Table C-2, **▲** or **▼** - Press until the proper setting is displayed.

(16) **▲** and **▼** - Press simultaneously.

(17) Repeat steps (12) through (16) until all of the menu items shown in Table C-2 have been set as indicated.

Table C-2.

MENU ITEM	SUBMENU	SETTING	DEFAULT
TX CLKS	-----	EXT CLK	NO
TRN SEQ	-----	6	YES
TX dELAY	-----	135 ms	YES
PREAM	-----	ENH	NO
dAT SENS	-----	MARK -	YES
CTS	Bd/BdL	188	NO
CTS	HF/PT	188	NO
CTS	LOS	188	NO
MILSTAR	-----	OFF	YES
TX LVL	-----	0	YES
IMPEd	-----	150 OHMS	NO

APPENDIX C (Cont)

Table C-2. (Cont)

MENU ITEM	SUBMENU	SETTING	DEFAULT
RTS/PTT	Bd/BdL	RTS	NO
RTS/PTT	HF	PTT	NO
RTS/PTT	LOS	PTT	NO
RTS/PTT	PT	PTT	NO

C.1.2 KY-100 Preset Configuration Procedure.

- | | |
|--|---|
| <ul style="list-style-type: none"> a. MODE switch - OFL. b. PRESET switch - Rotate to preset to be modified (1 - 6). c. ▲ or ▼ - Press until PRESET is displayed. d. INIT - Press. If NARROWBAND is not displayed, INIT - Press. The preset operating mode will flash. e. ▲ or ▼ - Press until NRW-BAND is displayed. f. INIT - Press, NARROWBAND is now selected. g. ▲ or ▼ - Press until MODEM SELECT is displayed. h. INIT - Press. | <ul style="list-style-type: none"> i. ▲ or ▼ - Press until BD is displayed. Press INIT to select this setting. j. Press ▲ or ▼ until RATE SELECT is displayed. Press INIT to select this setting. k. ▲ or ▼ - Press until RATE 24 is displayed. INIT - Press to select this setting. l. ▲ or ▼ - Press until KEY SELECT is displayed. INIT - Press to select this setting. m. ▲ or ▼ - Press until TEK 1 is displayed. INIT - Press to select this setting. n. ▲ or ▼ - Press until MODE SELECT is displayed. INIT - Press to select this setting. o. ▲ or ▼ - Press until HF VC VT is displayed. INIT - Press to select this setting. |
|--|---|

INDEX

Subject

**Paragraph
Figure, Table
Number**

#1 and #2

#1 and #2 CONV Caution Lights On	9.26.3
#1 or #2 FUEL FLTR BYPASS Caution Light On	9.25.1
#1 and #2 FUEL FLTR BYPASS Caution Lights On	9.25.2
#1 or #2 HYD PUMP Caution Light On and BACK-UP PUMP ON Advisory Light Off.....	9.27.4
#1 HYD PUMP Caution Light On.....	9.27.1
#1 or #2 PRI SERVO PRESS Caution Light On	9.27.5
#1 RSVR LOW and #1 HYD PUMP Caution Lights On With BACK-UP PUMP ON Advisory Light On	9.27.6
#1 FUEL LOW and #2 FUEL LOW Caution Lights On.....	9.25.3
#1 or #2 FUEL PRESS Caution Light On.....	9.25.4
#1 and #2 HYD PUMP Caution Lights On.....	9.27.3
#1 and #2 Generator Failure (#1 and #2 CONV and AC ESS BUS OFF Caution Lights On).....	9.26.1
#1 or #2 GEN Caution Light On.....	9.26.2
#2 RSVR LOW Caution Light On.....	9.27.8
#2 RSVR LOW and #2 HYD PUMP Caution Lights On With BACK-UP PUMP ON Advisory Light On	9.27.7
#2 HYD PUMP Caution Light On.....	9.27.2
#1 TAIL RTR SERVO Caution Light On and BACK-UP PUMP ON Advisory light Off or #2 TAIL RTR SERVO ON Advisory Light Off	9.22.6

A

AC Power Supply System	2.65
AC Secondary Bus EH	2.65.2
Accept/Reject Page EH	F 3-27
Accessory Module.....	2.45.2
Accumulator Recharge	2.69
After Emergency Action.....	9.4
After Landing Check.....	8.33
After Takeoff	8.30
Air Conditioner System EH	2.61
Air Conditioning System Power Priority EH	T 2-2

INDEX (Cont)

Subject	Paragraph Figure, Table Number
Aircraft Configuration Drag Changes For Use With Clean Cruise Charts.....	7.21
	7A.22
Aircraft Configuration Drag Changes For Use With High Drag Cruise Charts.....	7.22
	7A.23
Aircraft Torque Factor (ATF).....	F 7-2
	F 7A-2
Airspeed Charts	7.28
	7A.29
Airspeed Correction Aircraft With Wedge Mounted Pitot-Static Probes	F 7-36
Airspeed Correction Aircraft Without Wedge Mounted Pitot-Static Probes	F 7-35
Airspeed Correction Chart	F 7A.38
Airspeed Correction Chart - High Drag.....	F 7-37
	F 7A-39
Airspeed Correction Charts.....	7.28.1
	7A.29.1
Airspeed for Onset of Blade Stall	F 5-9
Airspeed Indicator	2.75
Airspeed Limitations Following Failure of the Automatic Stabilator Control System.....	5.21
Airspeed Operating Limits.....	F 5-6
Airspeed Operating Limits ES	F 5-7
	5.19
Airspeed Operating Limits (Volcano).....	F 5-8
	7A.28
Airspeed System Description.....	7.27
	7A.28
Airspeed System Dynamic Characteristics.....	7.28.2
	7A.29.2
Altimeter Encoder AAU-32A	F 2-22
	2.76
Altimeter Set AN/APN-209	F 3-29
Altimeter Set AN/APN-209(V)	3.26
AN/APR-39(V)2 Control Panel.....	F 4-5

INDEX (Cont)

Subject	Paragraph Figure, Table Number
AN/ASN-132(V) EH	3.16
Antenna Arrangement	F 3-1
Anticollision Lights.....	2.71.3
Appendix A, References.....	1.4
Appendix B, Abbreviations and Terms.....	1.5
Approved Fuels	T 2-5
APU	2.68
APU Compartment Fire.....	9.24.2
APU Controls	2.68.1
APU Fuel Control System (Helicopters equipped with GTC-P36-150 APU).....	2.68.3
APU Fuel Control System (Helicopters equipped with T-62T-40-1 APU).....	2.68.2
APU Fuel Supply System.....	2.68.4
APU Inlet Particle Separator (IPS) Kit. (Helicopters with IPS kit installed).....	4.26
APU Oil System Servicing.....	2.87
APU OIL TEMP HI Caution Light On.....	9.23.3
APU Operating Limitations	5.31
APU Source Engine Start	2.28.2
Arm	6.6.2
Armament Loading Data Moments	F 6-5
	6.13
Armament Subsystem.....	4.14
Arming Volcano System Canisters.....	F 4-21
Army Aviation Safety Program.....	1.7
ASE Status Panel EH	F 4-10
	4.13
Assault Mission Profile (4 - 230 Gallon Tanks).....	F 7-39
	F 7A-41
Assault Mission Profile (2 - 230 Gallon Tanks).....	F 7-40
	F 7A-42
Attitude Indicating System.....	2.73
Authorized Ammunition.....	T 4-2
Automatic Flight Control System (AFCS).....	2.37

INDEX (Cont)

Subject	Paragraph Figure, Table Number
Automatic Flight Control System (AFCS) Switch Panel	F 2-15
Autorotative Glide Distance Chart	F 9-4
Autorotative Glide Distance Chart-High Drag.....	F 9-5
Auxiliary AC Power System	2.66
Auxiliary Cabin Heater Control Panel	F 4-26
Auxiliary Electrical Cabin Heater (On helicopters equipped with auxiliary cabin heater kit).....	4.20
Auxiliary Fuel Management Control Panel.....	F 4-27
	4.20.3
Auxiliary Fuel Management Control Panel AFMS	F 4-27.1
	4.22A.2
Auxiliary Fuel Management Control Panel Test	4.20.5
Auxiliary Fuel Management System Fault Messages AFMS	T 4-4
Auxiliary Heater System. EH	2.62
Auxiliary Power Unit (APU) System.....	2.67
Auxiliary Power Unit (APU) (Typical).....	F 2-21
Average Arm	6.6.4
Aviation Life Support Equipment	8.3
Avionics Equipment Configuration	3.2
Avionics Power Supply.....	3.3
B	
Backup Hydraulic Pump Hot Weather Limitations	5.30
Backup Hydraulic System.....	2.40.3
Balance Definitions	6.6
Bank Angle Limitation.....	5.23.3.4
Basic Moment.....	6.6.5
BATT LOW CHARGE Caution Light On	9.26.5
Battery.....	2.64.2
Battery Charger/Analyzer.....	2.64.5
BATTERY FAULT Caution Light On	9.26.4
Bearing, Distance, Heading Indicator (BDHI) EH	4.5
Before Exterior Check	8.11
Before Landing.....	8.31

INDEX (Cont)

Subject	Paragraph Figure, Table Number
Before Leaving Helicopter.....	8.35
Before Starting Engines	8.21
Before Takeoff.....	8.28
Before Taxi.....	8.25
Blackout Curtains.....	2.55
Blade Deice System Control Panel	2.54.2
Blade Deice System Malfunctions.....	9.34
Blade Deice System Operation.....	2.54.1
Blade Deice Test.....	2.54.3
Blade Deice Test Panel.....	2.54.4
Boost Servo	2.36.4
BOOST SERVO OFF Caution Light On.....	
Built In Test (BIT) Chip Detectors	2.46.3
C	
Cabin Ceiling Tiedown Fittings.....	5.16
Cabin Dimensions	F 6-9
	6.15
Cabin Dome Lights	2.70.7
Cabin Doors.....	6.16
Cabin Interior	F 2-5
Cabin Mission Equipment Arrangement EH	F 2-6
Cabin Top (AREA 3).....	8.15
Cargo Center of Gravity Planning.....	6.20.2
Cargo Hook Moments	F 6-7
Cargo Hook System	F 4-23
	4.17
Cargo Hook Weight Limitation.....	5.17
Cargo Tiedown Arrangement.....	F 6-11
Caution/Advisory BRT/DIM - TEST Switch.....	2.81.2
Caution/Advisory and Warning Light Lighting Parameters.....	T 2-3
Caution/Advisory Light System.....	2.81.1
Caution/Advisory Panel UH	F 2-24

INDEX (Cont)

Subject	Paragraph Figure, Table Number
CDU and PDU Digital Control	2.10.4.3
CDU Controls and Indicators EH	F 3-19
Center of Gravity (CG).....	6.6.6
Center of Gravity Limitations.....	5.13
Center of Gravity Limits Chart	F 6-13
	6.21
Center of Gravity Limits Chart ES	F 6-14
Central Display Unit (CDU).....	2.10.4
CG Limits.....	6.6.7
Chaff and Flare Dispenser M130.....	4.3
Chaff Dispenser M130	4.3.1
Chapter 7 Index.....	7.2
Chapter 7A Index.....	7A.2
Charging (Cocking) Machinegun M60D.....	F 4-18
Checklist	8.9
CHIP INPUT MDL LH or RH Caution Light On	9.22.8
CHIP MAIN MDL SUMP, CHIP ACCESS MDL LH or RH, CHIP TAIL XMSN or CHIP INT XMSN/TAIL XMSN OIL TEMP or INT XMSN OIL TEMP Caution Light On.....	9.22.9
CIS Modes of Operation.....	F 3-32
Class.....	6.2
Climb/Descent	F 7-32
	F 7A-35
Climb/Descent Chart	7.23
	7A.24
Climb/Descent - High Drag.....	F 7-33
	F 7A-36
Clock.....	2.80
Cockpit Diagram	F 2-4
Cockpit Doors.....	2.11.1
Cockpit Equipment Checks.....	8.22
Cockpit Floodlights.....	2.70.2
Cockpit-Left Side (AREA 2).....	8.14

INDEX (Cont)

Subject	Paragraph Figure, Table Number
Cockpit-Right Side (AREA 8).....	8.20
Cold Weather Control Exercise.....	8.41.2
Cold Weather Operation.....	8.41
Cold Weather Preflight Check.....	8.41.1
Collective/Airspeed to Yaw (Electronic Coupling).....	2.35.4
Collective and Cyclic Grips.....	F 2-14
Collective Boost Servo Hardover/Power Piston Failure.....	9.27.9
Collective Bounce/Pilot Induced Oscillation.....	8.39.3
Collective Pitch Control Stick.....	2.35.2
Communication/Navigation Equipment.....	T 3-1
Compartment Diagram EH	2.7.2
Compartment Diagram UH	2.7.1
Compass Control Panel C-8021/ASN-75.....	F 3-29
Configuration Drag Change.....	T 7-1
	T 7A-1
Configurations ES	5.34
Control Display Unit AN/ARC-220.....	F 3-12.1
Control Panel KY-100(V).....	F 3-12.2
Control Panel RT-1296/APX-100(V).....	F 3-33
Converters.....	2.64.1
Countermeasures Set AN/ALQ-156(V)2 EH	4.10
Countermeasures Set AN/ALQ-162(V) EH	4.11
Crash-Actuated System.....	2.14.6
Crash Axe.....	2.15
Crew Briefing.....	8.5
Crew Chief/Gunner Seats.....	2.12.3
Crew Chief/Gunner Windows.....	2.11.3
Crew Call Switch/Indicator EH	4.2
Crew Duties/Responsibilities.....	8.4
Crew Seats.....	2.12
Crewmember's Cargo Hook Control Pendant.....	F 4-24
	4.15.3

INDEX (Cont)

Subject	Paragraph Figure, Table Number
Crossbleed Engine Start System.....	2.28.3
Cruise-Pressure Altitude Sea Level.....	F 7-7
	F 7A-9
Cruise - Pressure Altitude 2,000 Feet	F 7-9
Cruise - Pressure Altitude 2,000 Feet	F 7A-11
Cruise - Pressure Altitude 4,000 Feet	F 7-11
	F 7A-13
Cruise - Pressure Altitude 6,000 Feet	F 7-13
	F 7A-15
Cruise - Pressure Altitude 8,000 Feet	F 7-15
	F 7A-17
Cruise - Pressure Altitude 10,000 Feet	F 7-17
	F 7A-19
Cruise - Pressure Altitude 12,000 Feet	F 7-19
	F 7A-21
Cruise - Pressure Altitude 14,000 Feet	F 7-21
	F 7A-23
Cruise - Pressure Altitude 16,000 Feet	F 7-23
	F 7A-25
Cruise - Pressure Altitude 18,000 Feet	F 7-25
	F 7A-27
Cruise - Pressure Altitude 20,000 Feet	F 7-27
	F 7A-29
Cruise High Drag - Pressure Altitude Sea Level.....	F 7-8
	F 7A-10
Cruise High Drag - Pressure Altitude 2,000 Feet.....	F 7-10
	F 7A-12
Cruise High Drag - Pressure Altitude 4,000 Feet.....	F 7-12
	F 7A-14
Cruise High Drag - Pressure Altitude 6,000 Feet.....	F 7-14
	F 7A-16

INDEX (Cont)

Subject	Paragraph Figure, Table Number	
Cruise High Drag - Pressure Altitude 8,000 Feet.....	F	7-16
	F	7A-18
Cruise High Drag - Pressure Altitude 10,000 Feet.....	F	7-18
	F	7A-20
Cruise High Drag - Pressure Altitude 12,000 Feet.....	F	7-20

INDEX (Cont)

Subject	Paragraph Figure, Table Number
Cruise High Drag - Pressure Altitude 12,000 Feet.....	F 7A-22
Cruise High Drag - Pressure Altitude 14,000 Feet.....	F 7-22
	F 7A-24
Cruise High Drag - Pressure Altitude 16,000 Feet.....	F 7-24
	F 7A-26
Cruise High Drag - Pressure Altitude 18,000 Feet.....	F 7-26
	F 7A-28
Cruise High Drag - Pressure Altitude 20,000 Feet.....	F 7-28
	F 7A-30
Cryptographic Computer Kit-1C	3.28
Cyclic-Mounted Stabilator Slew Up Switch	2.38.3
Cyclic Stick	2.35.1
D	
Dashed Line Data.....	7.5.1
Data Basis.....	7.5.2
	7A.5.1
Data Compartments.....	2.58
DC and AC Circuit Breaker Panels (Typical)	F 2-20
	2.64.6
DC Monitor Bus EH	2.64.3
DC Power Supply System	2.64
DD Form 365-3 (Chart C) Weight and Balance Records	6.7
DD Form 365-4 (Form F).....	6.9
Decreasing % RPM R.....	9.14
Definition of Course Terms	F 3-18.2
Definition of Emergency Terms	9.3
Desert and Hot Weather Operation	8.42
Destruction of Army Materiel to Prevent Enemy Use	1.8
DF and ECM Operator's Seats EH	2.13.2
Digital Electronic Control (DEC) 701C	2.29.2
Dimensions	2.5
Direction Finder Set AN/ARN-89 (LF/ADF)	3.13

INDEX (Cont)

Subject	Paragraph Figure, Table Number
Direction Finder Set AN/ARN-149 (LF/ADF)	3.14
Discriminator Off Mode Display	F 4-2
Discriminator On Mode Display	F 4-3
Ditching-Power Off	9.28.3
Ditching-Power On.....	9.28.2
Door Locks	2.11.4
Doors and Windows.....	2.11
Doppler/GPS Navigation Set (DGNS) AN/ASN-128B UH	3.17A
Doppler/GPS Navigation Set AN/ASN-128B	F 3-18.1
Doppler World UTM Spheroids	F 3-22
Doppler Lamp Test Mode Display	F 3-18
Doppler Navigation Set AN/ASN-128 UH	F 3-17
	3.17
Downwind Hovering	5.23.2
Dual-Engine Failure	9.13
Dual-Engine Failure-General	9.12
Dual-Engine Fuel Flow	7.26
	7A.27
Dual-Engine Torque Limitations at Airspeeds Above 80 KIAS 701C	F 5-4
Dual-Engine Torque Limit.....	F 7A-5
Dual-Engine Torque Limits	7A.14
E	
ECM Antenna Switch EH	4.9
Effects of Blade Erosion Kit.....	7.15
	7A.16
EH-60A EH	2.4
EH-60A Helicopters Without Mission Equipment	6.14
EH-60A Data EH	8.2
Electrical Control Unit (ECU) 700	2.29.1
Electrical Fire In Flight.....	9.23.5
Electrical Power Systems.....	2.63
Electrical System.....	F 2-19

INDEX (Cont)

Subject	Paragraph Figure, Table Number
	9.26
Electronic Navigation Instrument Display System	3.25
Emergency Equipment (Portable).....	9.6
Emergency Exits.....	9.5
Emergency Exits and Emergency Equipment Diagram.....	F 9-1
Emergency Jettisoning	9.32
Emergency Landing In Wooded Areas. Power Off.....	9.28.1
Emergency Release of Rescue Hoist Load	9.33
Engine	2.17
Engine Alternator 700	2.19.1
Engine Alternator 701C	2.19.2
Engine and Engine Inlet Anti-Ice Limitations	5.29
Engine Anti-Icing	2.26.1
Engine Anti-Icing Systems	2.26
Engine Bleed Air	7.12
	7A.12
Engine Bleed-Air System.....	2.25
Engine Chip Detector.....	2.27.4
Engine Compressor Stall.....	9.18
Engine Control Quadrant	F 2-13
	2.29.3
Engine Control System	2.29
Engine Driven Boost Pump	2.18.1
Engine Emergency Oil System.....	2.27.1
Engine Fire In Flight.....	9.23.4
Engine Fuel Prime System.....	2.33
Engine Fuel Supply System.....	2.18
Engine Fuel System Components.....	2.18.4
Engine Fuel System Selector Control	2.32.2
Engine/Fuselage Fire On Ground	9.23.1
Engine High-Speed Shaft Failure	9.20
Engine Inlet Anti-Icing	2.26.2

INDEX (Cont)

Subject	Paragraph Figure, Table Number
Engine Instruments.....	2.31
Engine Limitations	5.8
Engine Malfunction-Partial or Complete Power Loss	9.7
ENGINE OIL FILTER BYPASS Caution Light On, ENGINE CHIP Caution Light On, ENG OIL PRESS HIGH/LOW, ENGINE OIL TEMP HIGH, ENGINE OIL TEMP Caution Light On, ENGINE OIL PRESS Caution Light On.....	9.19
Engine Oil Pressure Indicator.....	2.31.2
Engine Oil System	2.27
Engine Oil System Characteristics	8.41.4
Engine Oil System Servicing.....	2.86
Engine Oil Temperature Indicator	2.31.1
Engine Operation.....	8.41.3
Engine Overspeed Check Limitations	5.11
Engine Power Limitations 700	5.8.1
Engine Power Limitations 701C	5.8.2
Engine Power Turbine/Rotor Speed Indicator	2.31.5
Engine Restart During Flight.....	9.11
Engine % RPM Limitations.....	5.8.3
Engine Runup.....	8.24
Engine Speed Control System	2.29.5
Engine Start Envelope.....	F 5-5
Engine Start Limits	5.10
Engine Starter Limits	5.8.4
Engine Start System	2.28
Engine T700	F 2-11
Equipment Loading and Unloading.....	6.20
Equipment Stowage Compartments.....	6.19
ESSS Fuel System Degraded Operation Chart ES	T 4-3
Exceeding Operational Limits	5.3
Explanation of Change Symbols	1.10
Exterior Check.....	8.12
Exterior Check Diagram	F 8-1

INDEX (Cont)

Subject	Paragraph Figure, Table Number
Exterior Lights.....	2.71
External AC Power System.....	2.66.2
External Air Source/Electrical Requirements.....	2.85
External Auxiliary Fuel Management System AFMS	4.22A
External Extended Range Fuel Flow Verification in Manual Mode.....	4.20.7.3
External Extended Range Fuel Quantity Indicating System	4.20.4
External Extended Range Fuel System Degraded Operation Chart ERFS	T 4-3
External Extended Range Fuel System Failure To Transfer Symmetrically In Manual Mode ERFS	9.35
External Extended Range Fuel System Kit ERFS	4.22
External Extended Range Fuel System Kit Configurations ES	5.34
External Extended Range Fuel System Tanks	4.20.2
External Extended Range Fuel System Tank Jettison ES	9.36
External Extended Range Fuel Transfer Check.....	4.20.7
External Extended Range Fuel Transfer In Auto Mode.....	4.20.7.1
External Extended Range Fuel Transfer In Manual Mode.....	4.20.7.2
External Extended Range Fuel Transfer Modes	4.20.1
External Load Drag.....	F 7-30
	F 7A-33
External Load Drag Chart.....	7.20
	7A.21
External Source Engine Start.....	2.28.4
External Stores Fixed Provisions.....	4.21.1
External Stores Jettison Control Panel.....	4.21.4
External Stores Removable Provisions.....	4.21.2
External Stores Support System (ESSS) ES	4.23
F	
Fire.....	9.23
Fire Detection System.....	2.14.1
Fire Detector Test Panel	2.14.2
Fire Extinguisher Arming Levers (T-handles).....	2.14.4
Fire Extinguisher Control Panel	2.14.5
Fire Extinguishing Systems	2.14.3

INDEX (Cont)

Subject	Paragraph Figure, Table Number
Fire Protection Systems	2.14
First Aid Kits.....	2.16
Flare Dispenser M130 EH	4.3.2
Flight Characteristics.....	9.8
Flight Control/Main-Rotor System Malfunctions	9.29
Flight Control Servo Low-Pressure Caution Lights	2.36.2
Flight Control Servo Systems.....	2.36
Flight Control Servo Switch.....	2.36.1
Flight Control Systems.....	2.35
Flight Data Recorder (On Helicopters Equipped with Flight Data Recorder Kit).....	2.57
Flight In Icing Conditions.....	5.28
Flight Instrument Lights.....	2.70.3
Flight In Instrument Meteorological Conditions (IMC)	5.27
FLT PATH STAB Caution Light On.....	9.29.4
Flight Path Stabilization (FPS)	2.37.3
Flight With Cabin Door(s)/Window(s) Open.....	5.20
Flight With External Loads	8.39.1
Flying Qualities with External ERFs Installed ES	8.39.2
FM Control AN/ARC-114A	F 3-3
FM Control AN/ARC-201	F 3-7
Formation Lights	2.71.5
Forms and Records.....	1.9
Free Air Temperatures	7.9
	7A.9
Free-Air Temperature (FAT) Indicator	2.79
Fuel and Lubricants, Specifications, and Capacities.....	T 2-4
Fuel Boost Pump.....	2.34.2
Fuel Filter	2.18.2
	2.32.3
Fuel Fumes in Cockpit/Cabin With External Extended Range Fuel System Pressurized ES	9.37
Fuel Limitations	5.12
Fuel Low Caution Light.....	2.34.1

INDEX (Cont)

Subject	Paragraph Figure, Table Number
Fuel Moments.....	F 6-2 6.10

INDEX (Cont)

Subject	Paragraph Figure, Table Number
Fuel Pressure Warning System.....	2.18.3
Fuel Quantity Indicating System.....	2.34
Fuel Sampling System.....	2.84.5
Fuel Supply System.....	2.32
Fuel System.....	9.25
Fuel System Servicing.....	2.84
Fuel Tanks.....	2.32.1
Fuel Transfer Sequence.....	4.20.6
Fuel Types.....	2.84.1
Fuselage-Left Side (AREA 5).....	8.17
Fuselage-Right Side (AREA 7).....	8.19
G	
Gas Generator Speed (Ng) Indicator.....	2.31.4
General Arrangement.....	F 2-1
Generator Control Switches.....	2.66.1
Generator Control Units (GCU).....	2.65.1
Gravity Refueling.....	2.84.3
Ground Operations.....	8.43.5
Ground Resonance.....	8.38
Ground Taxi.....	8.26
Gust Lock Limitations.....	5.37
Gyro Magnetic Compass Set AN/ASN-43.....	3.24
H	
Hand-Operated Fire Extinguishers.....	2.14.7
Handpump Reservoir Servicing.....	2.88
Heads Up Display AN/AVS-7.....	F 4-7
	4.12
Heat and Ventilation Controls.....	2.59.2
Heating System.....	2.59
Height Velocity Diagram UH-60A EH	F 9-2
Height Velocity Diagram UH-60L	F 9-3
Helicopter Compartment and Station Diagram.....	F 6-1

INDEX (Cont)

Subject	Paragraph Figure, Table Number
	6.3
Helicopter Systems.....	9.1
High Drag Symbol	1.12
High Speed Yaw Maneuver Limitation.....	5.23.3.1
History Counter 701C	2.22
History Recorder 700	2.21
Horizontal Reference Datum	6.6.1
Horizontal Situation Indicator.....	F 3-31
	3.25.2
Hover Chart	7.14
	7A.15
Hover Check.....	8.27
Hover - Clean	F 7A-6
Hover-Clean Configuration	F 7-4
Hover-High Drag.....	F 7-5
	F 7A-7
Hover Infrared Suppressor Subsystem (HIRSS).....	2.30
HSI/VSI MODE SEL Panel E4	F 3-21
Hydraulic Leak Detection/Isolation System.....	2.41
Hydraulic Logic Module Operation Principle.....	F 2-16
Hydraulic Pump Modules	2.40
Hydraulic System	2.39
	9.27
Hydraulic Systems Servicing.....	2.89
I	
Ice and Rain Operation	8.43.3
Ice Rate Meter Fail or Inaccurate.....	9.34.3
Idle Fuel Flow	T 7-2
	T 7A-2
	7.24
	7A.25
IFM Amplifier Control.....	F 3-6

INDEX (Cont)

Subject	Paragraph Figure, Table Number
Ignition System.....	2.20
Immediate Action Emergency Steps	9.2
In-flight	8.43
In-flight Icing.....	8.43.4
Increasing % RPM R	9.15
Index	1.6
Infrared Countermeasure Set AN/ALQ-144(V).....	4.8
Infrared Suppressor System	7.13
	7A.13
Input Module	2.45.1
INS Page EH	F 3-24
Installation and Removal of Ammunition Can on Machinegun M60D.....	F 4-16
Installation of Ejector Control Bag on Machinegun M60D.....	F 4-15
Installation of Machinegun M60D on Pintle.....	F 4-14
Instrument Flight.....	8.36
Instrument Markings	F 5-1
Instrument Markings 700	F 5-2
Instrument Markings 701C	F 5-3
Instrument Marking Color Codes	5.5
Instrument Panel.....	F 2-9
	2.10
Instrument Panel UH	2.10.1
Instrument Panel EH	2.10.2
Integrated Inertial Navigation System (IINS) AN/ASN-132(V) EH	3.18
Intercommunication Control Panel C-6533/ARC	F 3-2
Intercommunication System C-6533/ARC.....	3.4
Interior Cabin (AREA 4)	8.16
Interior Lighting	2.70
Intermediate and Tail Gear Box Chip/Temperature Systems.....	2.47.3
Intermediate Gear Box	2.47.1
J	
Jettison Limits	5.35

INDEX (Cont)

Subject	Paragraph Figure, Table Number
L	
Landing.....	8.32
Landing and Ditching.....	9.28
Landing Gear Limitations.....	5.24
Landing Gear System.....	2.9
Landing Light.....	2.71.2
Landing Speed Limitations.....	5.25
VOL Launcher Racks Jettison.....	9.38
LF/ADF Control Panel C-7932/ARN-89.....	F 3-13
LF/ADF Control Panel AN/ARN-149.....	F 3-14
Lightning Strike.....	9.21
Limitations for Maneuvering With Rescue Hoist Loads.....	5.23.3.3
Limitations for Maneuvering With Sling Loads.....	5.23.3.2
Limits.....	7.4
	7A.4
Litter Support.....	4.24.1
Load Demand System.....	2.29.4
Loading Data.....	6.8
Location and Identification of Safety on Machinegun M60D.....	F 4-13
Logic Modules.....	2.42.4
Loss of Tail Rotor Thrust.....	9.22.1
Loss of Tail Rotor Thrust at Low Airspeed/Hover.....	9.22.2
Loss of No. 1 or No. 2 Generator During Blade Deice Operation.....	9.34.4
Lower Console.....	F 2-8
M	
Machinegun 7.62 Millimeter M60D.....	F 4-12
	4.15
Machinegun M60D Installation.....	F 4-11
Main Landing Gear.....	2.9.1
Main Rotor Blade and BIM [®] System.....	F 2-17
Main Rotor Blades.....	2.49.1
Main Rotor Gust Lock.....	2.49.2

INDEX (Cont)

Subject	Paragraph Figure, Table Number
Main Rotor System	2.49
Main Rotor Tiedown.....	2.95.2
Main Transmission BIT Chip Detector.....	2.46.3
Main Transmission Lubrication System.....	2.46
Main Transmission Module Limitations	5.7
Main Transmission Oil System Servicing.....	2.91
MAIN XMSN OIL PRESS Caution Light On/XMSN OIL PRESS LOW/XMSN OIL TEMP HIGH or XMSN OIL TEMP Caution Light On.....	9.22.7
Maintenance Light.....	2.70.8
Maneuvering Flight.....	8.39
Maneuvering Limitations	5.23.3
Manual Operation of the Stabilator.....	5.23.1
Master Mode Display.....	F 4-6.2
Master Warning Panel.....	F 2-23
Master Warning System.....	2.81
Maximum Cargo Size Diagram for Loading Through Cabin Doors	6.17
Maximum Package Size for Cargo Door.....	F 6-10
Maximum Torque Available	F 7A-4
Maximum Torque Available Chart.....	7.11
Maximum Torque Available - 30 Minute Limit.....	F 7-3
Medevac and Seat System	F 4-29
Medevac Kit Personnel Moments.....	6.12
Medevac Seats Installation.....	4.25.5
Medical Evacuation (Medevac) Kit.....	4.25
Minimum Crew Requirements.....	5.4
Mission Equipment Interface EH	3.30
Mission Kits	F 4-1
Mission Planning.....	8.1
Mission Readiness Circuit Breaker Panel	4.18
Mixing Unit.....	2.35.3
Moment.....	6.6.3
Mooring	F 2-26

INDEX (Cont)

Subject	Paragraph Figure, Table Number
	2.95
Mooring Instructions	2.95.1
MR DE-ICE FAULT or MR DE-ICE FAIL, or TR DE-ICE FAIL Caution Light On.....	9.34.1
N	
No. 1 Transfer Module	2.42.1
No. 2 Transfer Module	2.42.2
Nose Section (AREA 1).....	8.13
Number 1 Hydraulic System	2.40.1
Number 2 Hydraulic System	2.40.2
NVG Lighting System	2.70.1
O	
Observer's Seat EH	2.13.3
Operating Procedures and Maneuvers	8.7
Optimum Altitude For Maximum Range	F 7-29
Optimum Altitude For Maximum Range	F 7A-31
Optimum Altitude For Maximum Range - High Drag	F 7A-32
Optimum Range Charts.....	7.19
	7A.20
Overspeed and Drain Valve 701C	2.18.4.2
P	
Parking.....	2.93
Parking and Shutdown	8.34
Passenger Briefing.....	8.6
Pedal Bind/Restriction or Drive With No Accompanying Caution Light	9.22.5
Performance Data Basis-Clean	7.7
	7A.7
Performance Data Basis-High Drag	7.8
	7A.8
Performance Discrepancies	7.6
	7A.6
Personnel Moments	F 6-3
	6.11

INDEX (Cont)

Subject	Paragraph Figure, Table Number
Personnel Moments (Medevac Configuration).....	F 6-4
Pilot and Copilot VSI/HSI MODE SEL Panel EH	3.23
Pilot-Assist Controls.....	2.36.5
Pilot-Assist Servos	2.36.3
Pilot’s Display Unit (PDU).....	2.10.5
Pilot’s Seats	2.12.1
Pitch Boost Servo Hardover	9.27.10
Pitch, Roll or Yaw/Trim Hardover.....	9.29.5
Pitot Heater.....	2.53
Pitot-Static System	2.72
Placarded Aircraft Symbol.....	1.13
Pneumatic Source Inlet Limits.....	5.9
Pneumatic Subsystem.....	2.44
Position Lights.....	2.71.4
Position Page EH	F 3-23
Positioning Cartridge Link Belt on Machinegun M60D	F 4-17
Powertrain.....	2.45
Preflight Check.....	8.10
Pressure Refueling.....	2.84.4
Pressurizing and Overspeed Unit 700	2.18.4.1
Principal Dimensions	F 2-2
Prohibited Maneuvers.....	5.22
Protective Covers and Plugs.....	2.94
PWR MAIN RTR and/or TAIL RTR MONITOR Light On	9.34.2
Q	
Quick Fix Power EH	2.64.4
R	
Radar Altimeter Set AN/APN-209(V).....	F 3-34
	3.29
Radar Signal Detecting Set AN/APR-39A(V)1	4.7
Radar Signal Detecting Set AN/APR-39(V)2 EH	4.6
Radar Signal Detector Set AN/APR-39(V)-1	4.4

INDEX (Cont)

Subject	Paragraph Figure, Table Number
Radio Receiving Set AN/ARN-123(V)	F 3-15
Radio Receiving Set AN/ARN-123(V) (VOR/ILS/MB)	3.15
Radio Receiving Set AN/ARN-147(V) (VOR/ILS/MB)	3.16
Radio Retransmission Control	3.11
Radio Set AN/ARC-114A(VHF-FM) UH	3.5
Radio Set AN/ARC-115A (VHF-AM) UH	3.6
Radio Set AN/ARC-186(V)	3.7
Radio Set AN/ARC-201.....	
Radio Set, HF AN/ARC-220	3.12A
Rappeling Rope Connectors.....	4.24
Receiver-Transmitter Radio, RT-1167/ARC-164(V)	3.10
Receiver-Transmitter Radio, RT-1167C/ARC-164(V).....	3.9
Recommended Emergency External Fuel Tank Jettison Envelope.....	T 5-1
Refueling/Defueling	2.34.3
Remote Fill Panel.....	F 3-11
Rescue Hoist Kit UH	F 4-25
Rescue Hoist Lubrication System Servicing.....	2.90
Rescue Hoist Moments	F 6-8
Rescue Hoist System Kit	4.19
Rescue Hoist Weight Limitations.....	5.18
Reservoir Fill System.....	2.43
Restraint Criteria	6.20.3
Restricted Maneuvers	5.23
Retransmission Control Panel.....	F 3-12
	3.12
Rotor Blade Deice Kit	F 2-18
	2.54
	4.19
Rotor Limitations	5.6
Rotor Speed Limitations	5.6.2
Rotor Start and Stop Limits.....	5.6.1
Rotor Systems.....	2.48

INDEX (Cont)

Subject

**Paragraph
Figure, Table
Number**

Rotors, Transmissions and Drive Systems..... 9.22

INDEX (Cont)

Subject	Paragraph Figure, Table Number
% RPM Increasing/Decreasing (Oscillation).....	9.16
S	
Sample Cruise Chart	F 7A-8
Sample Cruise Chart - Clean.....	F 7-6
SAS Failure With No Failure/Advisory Indication.....	9.29.1
SAS 2 Failure Advisory Light On.....	9.29.2
SAS OFF Caution Light On	9.29.3
Scope.....	6.4
Searchlight	2.71.1
Self Deployment Mission Profile.....	F 7-38
	F 7A-40
Self-Test Patterns AN/APR-39(V)2.....	F 4-6
Series and Effectivity Codes.....	1.11
Service Platforms and Fairings.....	2.83
Servicing.....	2.82
Servicing Diagram.....	F 2-25
Signal Converter Unit, CV-3739/ASN-132. EH	3.20
Signal Validation - Fault Codes 701C	F 2-12
Single/Dual-Engine Fuel Flow.....	F 7-34
	F 7A-37
Single-Engine	7.18
Single-Engine	7A.19
Single-Engine Fuel Flow	7-25
	7A.26
Single-Engine Failure.....	9.10
Single-Engine Failure-General.....	9.9
Sling/Hoist Load Maneuvering Limitations	F 5-10
Slope Landing Limitations.....	5.26
Smoke and Fume Elimination	9.24
Special Mission Flight Profiles.....	7.29
	7A.30
Specific Conditions.....	7.5.3

INDEX (Cont)

Subject	Paragraph Figure, Table Number
	7A.5.2
Spheroid Data Codes EH	T 3-2
Stabilator Control Panel.....	2.38.1
Stabilator Malfunction-Auto Mode Failure	9.30
Stabilator Position Indicator.....	2.38.2
Stabilator System	2.38
Stability Augmentation System (SAS).....	2.37.1
Standby Magnetic Compass.....	2.78
Starting Engines	8.23
Stores Jettison Control Panel ES	F 4-28
Stowage Compartment Moments.....	F 6-12
Stowage Provisions	5.15
Symbol Generator Test Mode.....	F 4-9
Symbols Definition.....	8.8
System Annunciators EH	F 3-28
SYSTEMS SELECT Panel EH	F 3-20
	3.22
T	
TACAN Control Page EH	F 3-25
TACAN Navigational Set Receiver-Transmitter, RT-1159/A EH	3.21
Tail and Intermediate Gear Box Servicing	2.92
Tail Drive System	2.47
Tail Gear Box.....	2.47.2
Tail Landing Gear.....	2.9.3
Tail Pylon (AREA 6).....	8.18
Tail Rotor Control.....	2.35.5
Tail Rotor Pedals.....	2.35.6
TAIL ROTOR QUADRANT Caution Light On With Loss of Tail Rotor Control	9.22.4
TAIL ROTOR QUADRANT Caution Light On With No Loss of Tail Rotor Control	9.22.3
Tail Rotor Quadrant/Warning	2.51
Tail Rotor System	2.50
Takeoff.....	8.29

INDEX (Cont)

Subject	Paragraph Figure, Table Number
Taxiing.....	8.41.5
Taxiing and Ground Operation.....	8.42.1
Temperature Conversion Chart.....	F 7-1
	F 7A-1
TGT Temperature Indicator.....	2.31.3
The Main Module.....	2.45.3
Thermocouple Harness.....	2.23
Thunderstorm Operation.....	8.43.1
Tiedown Fittings and Restraint Rings.....	6.18
Torque and Overspeed and % RPM Sensors.....	2.24
Torque Available.....	7A.11
Torque Available - 10 Minutes.....	7A.11.1
Torque Available - 30 Minutes.....	7A.11.2
Torque Conversion Chart.....	F 7A-3
Torque Factor Method.....	7.10
	7A.10
Torque Factor Procedure.....	7.10.2
	7A.10.2
Torque Factor Terms.....	7.10.1
	7A.10.1
Torque Indicator.....	2.31.6
Transfer Modules.....	2.42
Transmission Chip Detector System.....	2.46.4
Transmission Oil Pressure Indicator.....	2.46.2
Transmission Oil Temperature Indicator.....	2.46.1
Transponder AN/APX-100(V)1(IFF).....	3.26
Transponder Computer KIT-1A/TSEC.....	3.27
Trim Actuator Jammed.....	9.29.6
Trim System.....	2.37.2
Troop/Cargo (Cabin) Doors.....	2.11.2
Troop Commander's Antenna.....	4.1
Troop Provisions UH	2.13

INDEX (Cont)

Subject	Paragraph Figure, Table Number
Troop Seat Belt Operation UH	2.13.1
Troop Seats UH	F 2-10
% TRQ Split Between Engines 1 and 2	9.17
Turbulence	8.43.2
Turbulence and Thunderstorm Operation.....	5.33
Turn Rate Indicating System	2.74
Turning Radius and Clearance.....	F 2-3
Turning Radius and Ground Clearance	2.6
Typical High Drag Configurations	F 7-31
	F 7A-34
Typical Self-Test Mode Display.....	F 4-4
U	
UH-60A UH-60A	2.2
UH-60A/L Master Mode Symbology Display (HUD)	T 4-1
	F 4-8
UH-60L UH-60L	2.3
UHF Control, AN/ARC-164(V)	F 3-8
Uncommanded Nose Down/Up Pitch Attitude Change.....	9.31
Update Page EH	F 3-26
Upper Console.....	F 2-7
Upper and Lower Console Lights	2.70.5
Upper and Lower Consoles	2.8
Use of Charts.....	7.5
	7.17
	7A.5
	7A.18
Use of Fuels	2.84.2
Use of M60D Gun(s) with ERFs Kit Installed ES	5.36
Use of Words Shall, Should, and May	1.14
Utility Lights	2.70.6
Utility Module	2.42.3

INDEX (Cont)

Subject	Paragraph Figure, Table Number
V	
Ventilation System	2.60
Ventilation System EH	2.60.2
Ventilation System UH	2.60.1
Vertical Instrument Display System (VIDS).....	2.10.3
Vertical Situation Indicator.....	F 3-30 3.25.1
Vertical Speed Indicator.....	2.77
VHF Control AN/ARC-115A	F 3-4
VHF Control Panel AN/ARC-186(V)	F 3-5
Voice Security Equipment	F 3-10
Voice Security System	3.11
Voice Security System Control C-8157/ARC.....	F 3-9
Volcano ICP	F 4-22
Volcano Mine Dispenser Controls.....	F 4-19
Volcano Mine Moments.....	F 6-6
Volcano Multiple Mine Delivery System	4.16
Volcano System DCU Displays.....	F 4-20
VOR/ILS/MB Control Panel AN/ARN-147 (V).....	F 3-16
VSI/HSI and CIS Mode Selector Panels.....	3.25.4
W	
Warnings, Cautions, and Notes	1.2
Weight Definitions	6.5
Weight Limitations.....	5.14
Weight-On-Wheels Functions.....	T 2-1
Wheel Brake System.....	2.9.2
Windshield Anti-Ice/Defogging System.....	2.52.2
Windshield Anti-Ice Limitations	5.32
Windshield Wiper Control.....	2.52.1
Windshield Wipers	2.52
Winterized Heater.....	2.59.1

INDEX (Cont)

Subject

**Paragraph
Figure, Table
Number**

Wire Strike Protection System..... 2.56

TM 1-1520-237-10

By Order of the Secretary of the Army:

DENNIS J. REIMER
General, United States Army
Chief of Staff

Official:

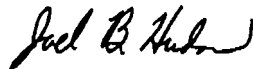

JOEL B. HUDSON
Administrative Assistant to the
Secretary of the Army
03477

DISTRIBUTION:

To be distributed in accordance with DA Form 12-31-E,
block no. 1284, requirements for TM 1-1520-237-10.



THEN ... JOT DOWN THE DOPE ABOUT IT ON THIS FORM, CAREFULLY TEAR IT OUT, FOLD IT AND DROP IT IN THE MAIL!

SOMETHING WRONG WITH THIS PUBLICATION?

FROM: (PRINT YOUR UNIT'S COMPLETE ADDRESS)

PFC John DOE
CO 4 3rd Engineer Bn
Ft. Leonardwood, MD 63108

DATE SENT

10 January 1999

PUBLICATION NUMBER

TM 1-1520-237-10

PUBLICATION DATE

30 December 1998

PUBLICATION TITLE

Operator's Manual for UH-60

BE EXACT PIN-POINT WHERE IT IS

IN THIS SPACE, TELL WHAT IS WRONG AND WHAT SHOULD BE DONE ABOUT IT:

PAGE NO	PARA-GRAPH	FIGURE NO	TABLE NO
6	2-1 a		
B1		4-3	

In line 6 of paragraph 2-1a the manual states the engine has 6 cylinders. The engine on my set only has 4 cylinders. Change the manual to show 4 cylinders.

Callout 16 in figure 4-3 is pointed at a bolt. In key to figure 4-3, item 16 is called a shim. Please correct one or the other

PRINTED NAME, GRADE OR TITLE, AND TELEPHONE NUMBER

JOHN DOE, PFC (268) 317-7111

SIGN HERE

JOHN DOE *John Doe*

FILL IN YOUR
UNITS ADDRESS

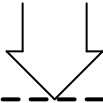

FOLD BACK

DEPARTMENT OF THE ARMY

OFFICIAL BUSINESS

COMMANDER
U.S. ARMY AVIATION AND MISSILE COMMAND
ATTN: AMSAM-MMC-MA-NP
REDSTONE ARSENAL, AL 35898-5230

TEAR ALONG PERFORATED LINE

FILL IN YOUR
UNITS ADDRESS

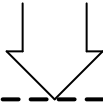

FOLD BACK

DEPARTMENT OF THE ARMY

OFFICIAL BUSINESS

COMMANDER
U.S. ARMY AVIATION AND MISSILE COMMAND
ATTN: AMSAM-MMC-MA-NP
REDSTONE ARSENAL, AL 35898-5230

TEAR ALONG PERFORATED LINE

FILL IN YOUR
UNITS ADDRESS

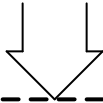

FOLD BACK

DEPARTMENT OF THE ARMY

OFFICIAL BUSINESS

COMMANDER
U.S. ARMY AVIATION AND MISSILE COMMAND
ATTN: AMSAM-MMC-MA-NP
REDSTONE ARSENAL, AL 35898-5230

TEAR ALONG PERFORATED LINE

The Metric System and Equivalents

Linear Measure

1 centimeter = 10 millimeters = .39 inch
 1 decimeter = 10 centimeters = 3.94 inches
 1 meter = 10 decimeters = 39.37 inches
 1 dekameter = 10 meters = 32.8 feet
 1 hectometer = 10 dekameters = 328.08 feet
 1 kilometer = 10 hectometers = 3,280.8 feet

Weights

1 centigram = 10 milligrams = .15 grain
 1 decigram = 10 centigrams = 1.54 grains
 1 gram = 10 decigrams = .035 ounce
 1 decagram = 10 grams = .35 ounce
 1 hectogram = 10 decagrams = 3.52 ounces
 1 kilogram = 10 hectograms = 2.2 pounds
 1 quintal = 100 kilograms = 220.46 pounds
 1 metric ton = 10 quintals = 1.1 short tons

Liquid Measure

1 centiliter = 10 milliliters = .34 fl. ounce
 1 deciliter = 10 centiliters = 3.38 fl. ounces
 1 liter = 10 deciliters = 33.81 fl. ounces
 1 dekaliter = 10 liters = 2.64 gallons
 1 hectoliter = 10 dekaliters = 26.42 gallons
 1 kiloliter = 10 hectoliters = 264.18 gallons

Square Measure

1 sq. centimeter = 100 sq. millimeters = .155 sq. inch
 1 sq. decimeter = 100 sq. centimeters = 15.5 sq. inches
 1 sq. meter (centare) = 100 sq. decimeters = 10.76 sq. feet
 1 sq. dekameter (are) = 100 sq. meters = 1,076.4 sq. feet
 1 sq. hectometer (hectare) = 100 sq. dekameters = 2.47 acres
 1 sq. kilometer = 100 sq. hectometers = .386 sq. mile

Cubic Measure

1 cu. centimeter = 1000 cu. millimeters = .06 cu. inch
 1 cu. decimeter = 1000 cu. centimeters = 61.02 cu. inches
 1 cu. meter = 1000 cu. decimeters = 35.31 cu. feet

Approximate Conversion Factors

<i>To change</i>	<i>To</i>	<i>Multiply by</i>	<i>To change</i>	<i>To</i>	<i>Multiply by</i>
inches	centimeters	2.540	ounce-inches	Newton-meters	.007062
feet	meters	.305	centimeters	inches	.394
yards	meters	.914	meters	feet	3.280
miles	kilometers	1.609	meters	yards	1.094
square inches	square centimeters	6.451	kilometers	miles	.621
square feet	square meters	.093	square centimeters	square inches	.155
square yards	square meters	.836	square meters	square feet	10.764
square miles	square kilometers	2.590	square meters	square yards	1.196
acres	square hectometers	.405	square kilometers	square miles	.386
cubic feet	cubic meters	.028	square hectometers	acres	2.471
cubic yards	cubic meters	.765	cubic meters	cubic feet	35.315
fluid ounces	milliliters	29.573	cubic meters	cubic yards	1.308
pints	liters	.473	milliliters	fluid ounces	.034
quarts	liters	.946	liters	pints	2.113
gallons	liters	3.785	liters	quarts	1.057
ounces	grams	28.349	liters	gallons	.264
pounds	kilograms	.454	grams	ounces	.035
short tons	metric tons	.907	kilograms	pounds	2.205
pound-feet	Newton-meters	1.356	metric tons	short tons	1.102
pound-inches	Newton-meters	.11296			

Temperature (Exact)

F	Fahrenheit temperature	5/9 (after subtracting 32)	Celsius temperature	C
----------	------------------------	----------------------------	---------------------	----------

