

109629

20P

First NASA Workshop on Wiring for Space Applications

(NASA-CP-10145) FIRST NASA
WORKSHOP ON WIRING FOR SPACE
APPLICATIONS (NASA, Lewis Research
Center) 181 p

N95-16044
--THRU--
N95-16057
Unclas

G3/20 0030136

*Proceedings of a workshop
cosponsored by NASA Headquarters, Office
of Safety and Mission Quality, and
NASA Lewis Research Center, and held
in Cleveland, Ohio, July 23-24, 1991*



NASA Conference Publication 10145

First NASA Workshop on Wiring for Space Applications

*Proceedings of a workshop
cosponsored by NASA Headquarters, Office
of Safety and Mission Quality, and
NASA Lewis Research Center, and held
in Cleveland, Ohio, July 23–24, 1991*



National Aeronautics and
Space Administration

Office of Management

**Scientific and Technical
Information Program**

1994

PREFACE

This document contains the proceedings of the First NASA Workshop on Wiring for Space Applications held at NASA Lewis Research Center (LeRC), Cleveland, Ohio, July 23-24, 1991. The workshop was sponsored by NASA Headquarters/Code QE Office of Safety and Mission Quality, Technical Standards Division and hosted by the NASA LeRC Power Technology Division, Electrical Components and Systems Branch. The workshop addressed key technology issues in the field of electrical power wiring for space applications. Topics discussed included wiring system operational experience, NASA wiring requirements, and wire manufacturing technologies. In addition to reviewing the ongoing NASA and other related programs on space wiring, the workshop provided a forum in which the government and industry representatives could discuss the results of their research programs on the development of arc track-resistant wiring systems.

The workshop organizers express their appreciation to the session chairmen, speakers, and participants, whose efforts contributed to the technical success of this event. Thanks are also due to Ms. Mindy Wolf for her relentless efforts in providing a well prepared and very efficient and organized workshop.

PRECEDING PAGE BLANK NOT FILMED

TABLE OF CONTENTS

SUMMARY	vii
AGENDA	ix
SESSION I—ORGANIZATIONS AND PROGRAMS	1
NASA Code Q Overview Daniel R. Mulville, NASA Headquarters	3
SESSION II—WIRING APPLICATIONS AND STANDARDS	9
Kapton Wire Concerns for Aerospace Vehicles J. Van Laak, NASA Johnson Space Center	11 ⁻¹
Orbiter Kapton Wire Operational Requirements and Experience R.V. Peterson, Rockwell International	19 ⁻²
WSTF Electrical Arc Projects Larry Linley, NASA Johnson Space Center, White Sands Test Facility (WSTF)	43 ⁻³
Problems with Aging Wiring in Naval Aircraft Francis J. Campbell, Naval Research Laboratory	61 ⁻⁴
Kapton Pyrolysis on Space Station Freedom's Solar Array Flexible Current Carrier Thomas J. Stueber, Sverdrup Technology, Inc.	73 ⁻⁵
Combustion and Fires in Low Gravity Robert Friedman, NASA Lewis Research Center	81 ⁻⁶
SESSION III—WIRING REQUIREMENTS	91 ^{-omit}
NASA Wiring for Space Applications Program Daniel R. Mulville, NASA Headquarters	93 ^{omit}
Space Station Freedom Primary Power Wiring Requirements Thomas J. Hill, NASA Lewis Research Center	95 ⁻⁷
Space Station Freedom Secondary Power Wiring Requirements C.R. Sawyer, Boeing Aerospace and Electronics Company	99 ⁻⁸
Space Wiring Workshop—ELV Requirements Bill McPeak, NASA George C. Marshall Space Flight Center	111 ^{omit}
A Study of Electric Transmission Lines for Use on the Lunar Surface Krista L. Gaustad, Lloyd B. Gordon, and Jennifer R. Weber, Auburn University	115 ⁻⁹
Kapton Pyrolysis, The Space Environment and Wiring Requirements Dale C. Ferguson, NASA Lewis Research Center	125 ⁻¹⁰
AEO Briefing to Workshop on Wiring for Space Applications John Reagon, NASA Lewis Research Center	133 ^{omit}

SESSION IV—CANDIDATE INSULATION MATERIALS AND CONSTRUCTIONS	135
	<i>omit</i>
High Temperature Polymer Dielectric Film-Wire Insulation	
John G. Nairus, Wright Laboratory, Wright Patterson Air Force Base	137
	<i>5-11</i>
New Insulation Constructions for Aerospace Wiring Applications	
George Slenski, Wright Laboratory, Wright Patterson Air Force Base	143
	<i>12</i>
Aerospace Wire and Cable	
David H. Berkebile, E.I. du Pont De Nemours & Co., Inc.	163
	<i>13</i>
Wire and Cable Design for Space Applications—New Ideas	
Bruce Pike, Teledyne Thermatics	169
	<i>omit</i>
High Performance Dielectric Materials Development	
Joe Piché, Ted Kirchner, and K. Jayaraj, Foster Miller, Inc.	173
	<i>14</i>
LIST OF ATTENDEES	181

FIRST NASA WORKSHOP ON WIRING FOR SPACE APPLICATIONS

SUMMARY

The First NASA Workshop on Wiring For Space Applications was held at NASA Lewis Research Center, Cleveland, Ohio, July 23-24, 1991. The workshop was sponsored by NASA Headquarters, Code QE, Office of Safety and Mission Quality, Technical Standards Division and hosted by the NASA LeRC Power Technology Division, Electrical Components and Systems Branch. The workshop addressed key technology and development issues pertaining to electrical power wiring for space-based applications.

The workshop was organized into four sessions. Session I provided an overview of the NASA Office of Safety and Mission Quality, Code QE, organization, structure, charter, and operating plans and programs. A summary of wiring system failures induced by arc tracking and their impact was also discussed.

Session II discussed the performance of various electrical insulation constructions in aerospace vehicles which have been experienced during service as well as during testing. These included the space shuttle, Space Station Freedom, and Naval aircraft. A summary of the concerns and recommendations to address the problems associated with wiring insulation breakdown in aerospace wiring systems was also presented in this section.

Session III focused on the unique operational requirements which are representative of the various NASA missions. These include the Space Station Freedom primary and secondary power requirements, the Space Shuttle Orbiter, expendable launch vehicles and Lunar and Martian surface missions. Discussions focused on the electrical, mechanical, and environmental conditions which the space vehicles, as well as the wiring systems, will be exposed to during their operational lifetimes.

Session IV considered new candidate insulation materials and hybrid wiring constructions which may improve the performance and reliability of wiring systems. Presentations were given by industry representatives on the development in the area of high temperature, high performance, arc track-resistant wiring insulation and dielectrics for aerospace applications. New wiring constructions and cable designs were also presented. The workshop was attended by approximately 60 individuals from various government agencies, industry, and academia. A list of the attendees and the final workshop agenda are included in these proceedings.

In response to the issues raised at the workshop, A NASA Office of Safety and Mission Quality (Code Q) program was established to identify and characterize wiring systems in terms of their potential use in aerospace vehicles. The goal of the program is to provide the information and guidance necessary to develop and qualify reliable, safe, lightweight wiring systems which are resistant to arc tracking and

suitable for use in space power applications. This program will be managed by NASA Lewis Research Center, Power Technology Division, Electrical Components and Systems Branch under the top level management of NASA Headquarters, Office of Safety and Mission Quality, Technical Standards Division (Code QE). The continued participation of the other NASA centers, DOD laboratories, wiring and aerospace industries, and academia is anticipated during the course of the program.

The organizers once again express their appreciation to the volunteers and participants in making this workshop a very interesting and successful event. The support of NASA Headquarters Code QE for this program is gratefully acknowledged.

FIRST NASA WORKSHOP ON WIRING FOR SPACE APPLICATIONS

AGENDA

July 23-24, 1991
NASA Lewis Research Center
NASA Administration Building (Bldg. No. 3)
Auditorium

Tuesday, July 23

Session I: Organizations and Programs

<u>Time</u>	<u>Topic</u>	<u>Speaker</u>	<u>Organization</u>
8:00 - 8:15	Opening Remarks	R. Bercaw	NASA/LeRC
8:15 - 8:30	NASA Code Q Overview	D. Mulville	NASA/HQ

Session II: Wiring Applications and Standards

<u>Time</u>	<u>Topic</u>	<u>Speaker</u>	<u>Organization</u>
8:30 - 9:00	Kapton Wire Concerns for Aerospace Vehicles	J. VanLaak	NASA/JSC
9:00 - 9:30	Orbiter Kapton Wire Operational Requirements and Experience	R. Peterson	Rockwell International
9:30 - 10:00	WSTF Electrical Arc Projects	L. Linley	NASA/JSC/WSTF
10:00 - 10:30	Problems with Aging Wiring in Naval Aircraft	F. Campbell	Naval Research Laboratory
10:30 - 11:00	Kapton Pyrolysis on Space Station Freedom's Solar Array Flexible Current Carrier	T. Stueber	NASA/LeRC/Sverdrup
11:00 - 11:30	Combustion and Fires in Low Gravity	R. Friedman	NASA/LeRC
11:30 - 12:30	Lunch		

Session III: Wiring Requirements

<u>Time</u>	<u>Topic</u>	<u>Speaker</u>	<u>Organization</u>
12:30 - 1:00	Wiring for Space Applications Workshop Objectives	D. Mulville	NASA/HQ
1:00 - 1:30	Space Station Freedom Primary Power Wiring Requirements	T. Hill	NASA/LeRC
1:30 - 2:00	Space Station Freedom Secondary Power Wiring Requirements	C. Sawyer	Boeing

2:00 - 2:30	Expendable Launch Vehicle Wiring Requirements	B. McPeak	NASA/MSFC
2:30 - 3:00	Break		
3:00 - 3:30	A Study of Electrical Transmission Lines for Use on the Lunar Surface	K. Gaustad	Auburn University
3:30 - 4:00	Kapton Pyrolysis, The Space Environment and Wiring Requirements	D. Ferguson	NASA/LeRC
4:00 - 4:30	AEO Briefing to Workshop on Wiring for Space Applications	J. Reagan	NASA/LeRC

Wednesday, July 24

Session IV: Candidate Insulation Materials and Constructions

<u>Time</u>	<u>Topic</u>	<u>Speaker</u>	<u>Organization</u>
8:30 - 9:00	High Temperature Polymer Dielectric Film-Wire Insulation	J. Nairus	U.S. Air Force
9:00 - 9:30	New Insulation Constructions for Aerospace Wiring Applications	G. Slenski	U.S. Air Force
9:30 - 10:00	Aerospace Wire and Cable	D. Berkebile	Du Pont
10:00 - 10:30	Wire and Cable Design for Space Applications - New Ideas	B. Pike	Teledyne Thermatics
10:30 - 11:00	Break		
11:00 - 11:30	High Performance Dielectric Materials Development	J. Piché	Foster Miller
11:30 - 12:00	Closing Remarks/Discussions	R. Bercaw	NASA/LeRC

SESSION I:

ORGANIZATIONS AND PROGRAMS

NASA CODE Q OVERVIEW

NASA WORKSHOP ON WIRING FOR SPACE APPLICATIONS

JULY 23-24, 1991

DR. DANIEL R. MULVILLE
DIRECTOR, TECHNICAL STANDARDS DIVISION
NASA HEADQUARTERS

OSMQ
CODE QE

TECHNICAL STANDARDS DIVISION

- ORGANIZATION
- CHARTER
- OPERATING PLAN/PROGRAMS

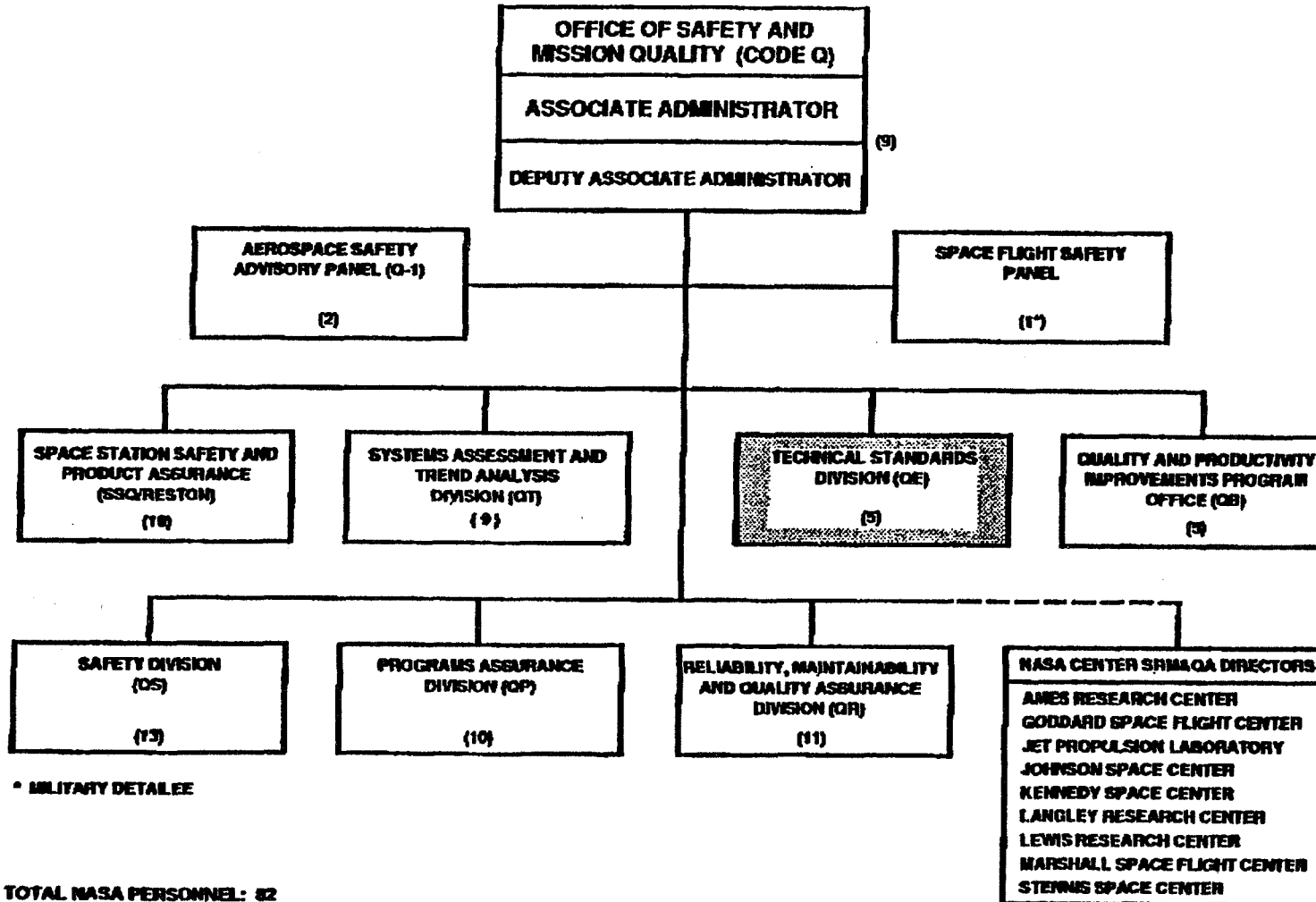

* MILITARY DETALLEE

TOTAL NASA PERSONNEL: 82

4



CODE QE

CODE QE ORGANIZATION

5

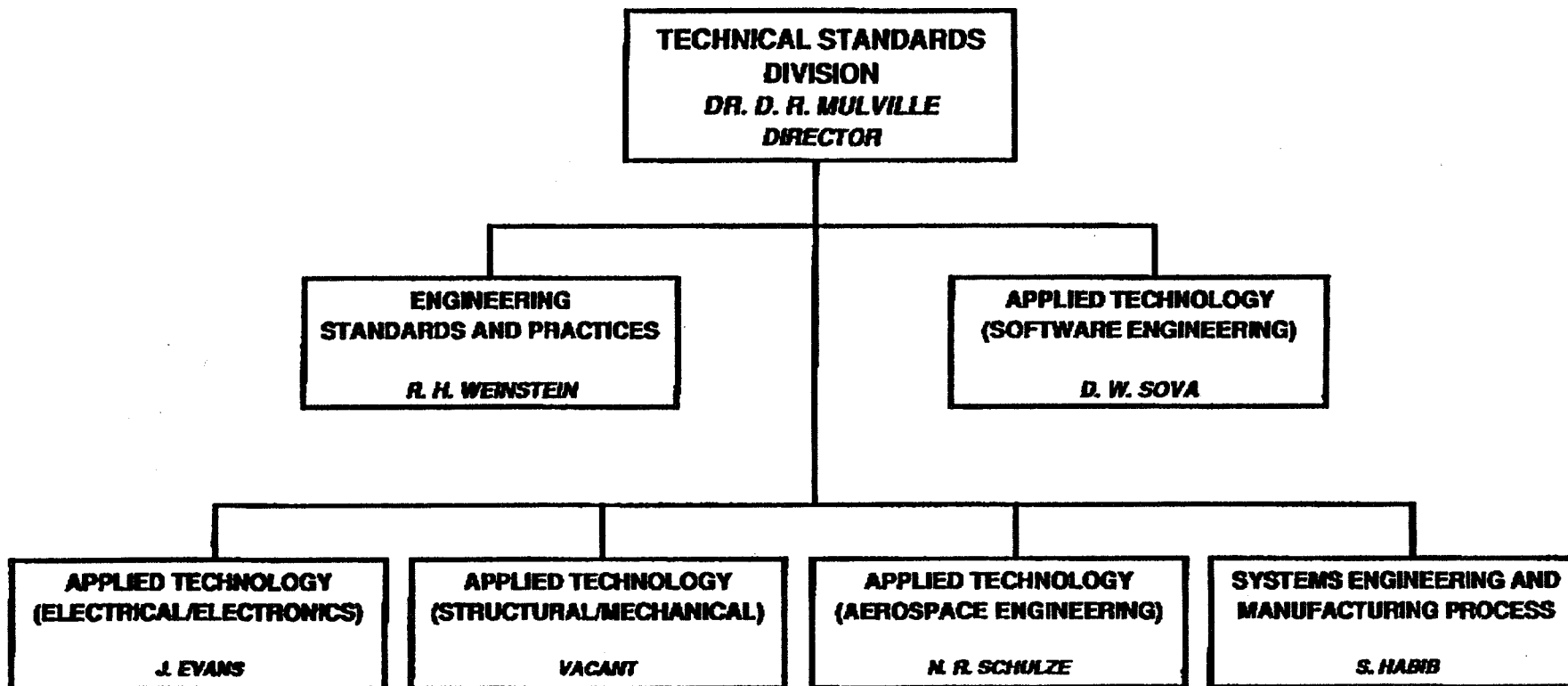



CODE QE CHARTER

CODE QE

- **PURPOSE**
 - **PROVIDE THE FOCUS FOR THE COORDINATION AND ADVOCACY REQUIRED TO DEVELOP AND MAINTAIN TECHNICAL STANDARDS AND IMPROVED CAPABILITY TO SUPPORT SAFETY AND RELIABILITY OF PROGRAM HARDWARE AND FLIGHT SYSTEMS**

- **FUNCTIONS**
 - **DEVELOP STANDARDS, PRACTICES, AND PROCESSES TO SUPPORT THE DESIGN, BUILD, AND QUALIFICATION OF HARDWARE AND FLIGHT SYSTEMS**
 - **ENHANCE NASA'S ENGINEERING CAPABILITY THROUGH DEVELOPMENT OF IMPROVED ANALYSIS, TEST, AND QUALIFICATION TECHNIQUES**
 - **DEMONSTRATE CRITICAL APPLIED TECHNOLOGIES TO IMPROVE THE PERFORMANCE AND RELIABILITY OF PLANNED HARDWARE/FLIGHT PROJECTS OR PROVIDE SOLUTIONS TO CURRENT PROBLEM TRENDS**

- **WORKING RELATIONSHIPS**
 - **HEADQUARTERS OFFICES AND FIELD CENTERS**
 - **ESTABLISH AND MAINTAIN NASA-WIDE TECHNICAL STANDARDS**
 - **PROGRAM OFFICES AND CODE R**
 - **BRIDGE BETWEEN RESEARCH AND TECHNOLOGY AND PROGRAMMATIC NEEDS**
 - **ENGINEERING MANAGEMENT COUNCIL**
 - **"STEERING COMMITTEE" TO DEVELOP PRIORITIES**
 - **INVOLVE ENGINEERING ORGANIZATIONS IN CODE QE INITIATIVES**
 - **OMB/CONGRESS**
 - **ADVOCATE NASA ENGINEERING CAPABILITY AND ENHANCEMENT**

- **PROGRAMS**

- **ENGINEERING STANDARDS AND PRACTICES** **ESTABLISH/MAINTAIN ENGINEERING STANDARDS FOR NASA-WIDE APPLICATION**
- **APPLIED TECHNOLOGIES** **DEVELOP/IMPLEMENT CURRENT AND NEXT GENERATION TECHNOLOGIES FOR ELECTRICAL/ELECTRONIC AND STRUCTURAL/MECHANICAL COMPONENTS AND SYSTEMS, AEROSPACE ENGINEERING, AND SOFTWARE ENGINEERING**
- **SYSTEMS ENGINEERING AND MANUFACTURING PROCESS** **IMPROVE EFFECTIVENESS OF PROGRAM DEVELOPMENT/MANUFACTURING PROCESS**

- **ENGINEERING STANDARDS AND PRACTICES**

- **PROGRAM DEVELOPMENT**
- **STANDARDS DEVELOPMENT**
- **CAPABILITY DEVELOPMENT**
- **METRIC TRANSITION**
- **PRODUCT DATA EXCHANGE INITIATIVE**

- **APPLIED TECHNOLOGY**

- **AEROSPACE FLIGHT BATTERY SYSTEMS**
- **ELECTRONIC PACKAGING AND ASSEMBLY**
- **FIBEROPTIC ROTATION SENSOR**
- **SOFTWARE ENGINEERING**
- **PYROTECHNIC ACTUATED SYSTEMS**
- **AEROSPACE WIRING SYSTEMS**

- **SYSTEMS ENGINEERING AND MANUFACTURING PROCESS**

SESSION II:

WIRING APPLICATIONS AND STANDARDS

PRECEDING PAGE BLANK NOT FILMED

N95- 16045

Kapton Wire Concerns for Aerospace Vehicles

51-33
30137
P. 7
109630
BP

J. Van Laak

Maintenance Operations Manager

DE 111

NASA Johnson Space Center

Agenda

Background

Shuttle Status

Test/Research Programs

Recommendations for Shuttle

Recommendations for Freedom

Conclusions

Background

- o **Rapid growth of electrical system size and weight**
- o **Aerospace industry evolved new requirements**
 - **Smaller conductors and thinner insulation films**
 - **Higher temperature insulation materials**
 - **Improved abrasion resistance**
- o **Kapton has high temperature rating and good abrasion resistance**
- o **New failure modes introduced but not recognized**
 - **Conductive char formation**
 - **Energy density of harnesses increased**
- o **Fly by wire vehicles raise the criticality of the electrical system**
- o **Arc-tracking facts:**
 - **Two kinds: wet and dry**
 - **Requires an initiating event (i.e., insulation damage)**
 - **Not a combustion process**
 - **An extended ignition source (time and space)**
 - **Failure can cascade through a harness (flashover)**
 - **Flashover can fail an entire harness**
 - **Failure propagates rapidly**
 - **Conventional circuit protection does not prevent**
 - **Substantial failure history in DOD (500+) and NASA (5+) arc propagating events**
 - **Use of Kapton wire has been severely restricted by many agencies**

Shuttle Status

- o **NASA HQ investigation concluded that the risk of Kapton arc-tracking/flashover is a credible threat to the orbiter**
 - **Risk of another arcing event over life of program is high**
 - **Risk of loss of mission/early return is moderate**
 - **Risk of loss of vehicle is at least an order of magnitude less than risk resident in the propulsive elements**
- o **Risk can be substantially lessened**
 - **Orbiter not originally engineered with consideration for these failure modes**
 - **Maintenance and inspection can compensate for many shortcomings**
- o **Pre-STS-26 rationale not valid**
 - **Depended on four fundamental elements**
 - Aerospace quality wire installation will preclude wire damage**
 - Physical protection installed in high traffic areas**
 - Circuit protection will prevent damage propagation**
 - Redundancy separation will preclude crit 1 events**
- o **Detailed review of rationale revealed the following:**
 - **Quality of wire installation and maintenance:**
 - Shuttle built to 1970's "aerospace Standard" & did not account for arc-tracking/flashover failure modes**
 - Wire damage and short circuits fairly common**
 - Most damage not due to negligence**

Status (cont)

- **Physical protection installed in high traffic areas:**
 - Level of effort reflected low credibility of threat**
 - Rubber pads used to crawl on wiring in ECLSS bay**
 - Some convoluted tubing applied at high traffic points**
 - Sheetmetal cable covers installed on VESS**
 - Other protection defined but not implemented**

- **Circuit protection to prevent damage propagation**
 - Not designed to detect/prevent arcing**
 - Resistance to inadvertent tripping is critical**
 - JSC Orbiter breadboard shows ineffective for 28 volt DC events**
 - JSC data inconclusive for 115 volt AC events**
 - STS-6 event was in AC harness & destroyed harness**

- **Redundancy separation of critical functions precludes Crit 1 events**
 - Requirements allowed exceptions in certain areas**
 - These exceptions not recorded or tracked**
 - FMEA/CIL review of wiring deleted from program**

JSC testing and flight experience have demonstrated that failure propagation can result in loss of an entire harness

Rationale for Flight

- o Rationale adequate for continued flight for time being
 - Wiring generally well installed and maintained
 - Physical protection installed at highest risk locations
 - Additional protection being installed as practical
 - Training and hardware inspection highlight concerns
 - Flight rules preclude resetting tripped circuit breakers
 - Small number of crit 1 harnesses and low risk of crit 1 event
 - Continued attention required to control risk
 - Risk is unacceptably high for inclusion in new builds

Testing/Research

- o NASA development of new insulation materials is not practical
- o Improved understanding of insulation material properties in a systems level context is critical
- o New testing programs address NASA requirements:
 - WSTF program to determine minimum energy level to sustain arc-propagation in MIL-W 81381 (Kapton) wire
 - 4 watts for 26 awg wire
 - 8 watts for 20 awg wire
 - WSTF program to determine physics-based limits of insulation resistance to arc-propagation
 - Analytical math model development (Battelle)

Recommendations for Shuttle

- o Increase emphasis on mitigating this risk**
- o Physical protection must be stressed**
 - Add protection where logical before damage is noted**
- o Thorough, dedicated inspections should continue regularly**
- o Redundancy and its limits should be understood:**
 - Crit 1 harnesses should be identified**
 - re-routing/replacement when practical**
 - Special inspection/protection when not**
 - Should understand downmoding to crit 1 harnesses when all remaining redundancy is in one harness**

Recommendations for Station

- o Do not use Kapton wire (MIL-W 81381) for any power circuits**
- o Do not ban the use of Kapton**
 - May be ideal for low power signal wires**
 - OK for use as structural applications such as solar array blankets**
 - Flexible circuits have shown susceptibility to arc-tracking**
 - Kapton may be safely used in correctly designed hybrid wire constructions (i.e., TKT) to improve abrasion resistance**
- o Electrical systems should be designed to preclude arc-propagation regardless of insulation material**

Conclusions

- o **Arc-propagation poses a significant and credible threat to mission safety and success in aerospace vehicles**
- o **Wire construction has a significant impact on the probability of arc-propagation**
 - **Resistance to damage**
 - **Formation of conductive char**
- o **If permitted, arc-propagation can result in the failure of any wire bundle above a critical energy potential**
 - **Includes primary power cabling if bundled with returns**
- o **Station should be designed to tolerate reasonable levels of wire damage without failure propagation to adjoining wires**
- o **Kapton (MIL-W 81381) wire or its equivalent should not be utilized in new builds for power applications**

352962 N95-16046

20120
P. 2324
109631

ORBITER KAPTON WIRE OPERATIONAL REQUIREMENTS AND EXPERIENCE

R.V. Peterson
Rockwell International

LEWIS RESEARCH CENTER SPACE APPLICATION WIRING WORKSHOP JULY 23, 1991

R. V. PETERSON
213-922-3144

AGENDA

- **ORBITER WIRE SELECTION REQUIREMENTS**
- **ORBITER WIRE USAGE**
- **FABRICATION & TEST REQUIREMENTS**
- **TYPICAL WIRING INSTALLATIONS**
- **KAPTON WIRE EXPERIENCE**
- **NASA KAPTON WIRE TESTING**
- **SUMMARY**
- **BACKUP DATA**

ORBITER REQUIREMENTS FOR GENERAL PURPOSE WIRE (6/73)

- **MINIMUM WEIGHT WITHOUT COMPROMISING CONDUCTOR INSULATION INTEGRITY**
- **TEMPERATURE (OPERATING) -100°F TO 260°F**
- **NON-FLAMMABLE/NO OUTGASSING/NON-TOXIC**
- **RESISTANCE TO DAMAGE DURING & AFTER INSTALLATION**
- **NO DEGRADATION DUE TO VACUUM EXPOSURE**
- **COMPLIANCE WITH ELECTRICAL REQUIREMENTS**
- **PRODUCIBILITY-UTILIZATION OF STANDARD TOOLS & TECHNIQUES TO FABRICATE HARNESSSES & TERMINATE WIRES IN CRIMP OR SOLDER CONNECTIONS AND MARKABILITY**
- **MINIMUM COST**

WIRE PROPERTIES SUMMARY

















JUNE, 73

INSULATION PROPERTY	KAPTON	TEFLON TE	POLY-Y	TEFZEL	HALAR
Physical					
Specific Gravity	1.42	2.15	1.33	1.70	1.68
Tensile/Yield	19k/7.9k	3-5k	13.2k	6.5k/4.0k	5.26k
Flex Life; Insulated Wire	130 cycles	160 cycles	Not Tested	85 cycles	Not Tested
Cut-Through Resistance 150°C	pass	pass	pass	Fail	Fail
Notch Sensitivity	8.25kv at 4 mil cut In 6 mil Insul vs 49kv w/o cut	26kv at 4 mil cut In 10 mil Insul vs 34.2kv w/o cut	3kv 6 mil cut In 10 mil wall	Passes 60% Notch	No Data
Wear Abrasion Resistance					
Scrape 25°C	4k cycles 10 mils	5k cycles 12 mil	30 cycles 10 mil	No Data	No Data
Tape 25°C	3 Inches 1/4 lb load	30 Inches 1/4 lb load	63 In 1 lb load	35 Inches	28.5 Inches
Tape 25°C	normal wt 6 Inches light wt 1 Inch	 10 Inches	 10.5 Inches	 7 1/8 inches	Not Tested
Thermal					
Service Temp	200°C	250°C	200°C	150°C	165°C
Melting Point	None	327°C	365°C	271°C	245°C
Flammability/Smoke	pass	pass	pass	pass	pass
Low Temp Embrittlement	-65°C	-100°C	-65°C	-100°C	180° Bend @ -5°C per MIL- W-22759/13
Low Temp Embrittlement (Note 1)	pass -65°C	pass - 65°C	pass - 65°C	pass - 65°C	Not Tested
Heat Distortion	no change	no change	no change	no change	Not Tested
Insul. Shrinkage	no change	no change	no change	no change	Not Tested

Legend: Indicates data source - see enclosure

WIRE PROPERTIES SUMMARY (continued)

JUNE, 73

INSULATION PROPERTY	KAPTON	TEFLON TE	POLY-Y	TEFZEL	HALAR
Electrical					
Dielectric Constant	3.46	2.1	3.4	2.6	2.5
Dielectric Strength v/mil	2500 	1160 	1000 	1480 	1870
Insulation Resistance 25°C Megohm/1000 ft	3000 	2250 	5000 		2000 
175°C	12 	12 	50 	31 	
Chemical					
Water Absorption	1%-3% Note 1	0.1%	0.3% 	0.02%	0.01% 
Chemical Resistance	unaffected	unaffected	unaffected	unaffected	unaffected
to the following chemicals:					
1. Nitrogen Tetroxide					
2. MMH Hydrazine					
3. Skydrol 500A					
4. Aerosafe 2300					
5. Jet Fuel JP4					
6. Ethylene Glycol					
7. Freon					
8. Lube Oil					
Wire Weight					
	 107%	124%	100%	Not Quoted	Not Quoted
Cost					
	 100%	145%	142%	Not Quoted	Not Quoted

Note 1: Water absorption applies to Kapton mat'l. When fabricated into wire, an impervious top coat is added and provides a barrier to moisture.

Data Sources

JUNE, 73

- ▷ LOCKHEED RPT. #24-004 Oct. 10, 1969
 1. Cut-Through Resist:: Ref. P.24; Test - 10 mil radius blade forced .05 inch/min into insulation, record pounds req'd.
 2. Notch Sensitivity: Ref. P. 23; Test - 4 or 65 mil razor cut then wrap over 1/4" diameter rod cut faces out, record dielectric breakdown volts - indicates decrease in effective insulation.
 3. Wear Abrasion: Ref. P. 29; Test - 1kgm wt on 10 mil radius back-and forth, record cycles to fail. (scrape abrasion)
- ▷ DUPONT TEFZEL SPEC. SHT. APD #4 July 20, 1971
 1. Wear Aprasion: Ref. P.3; Test - 1.0 lb vert wt on wire, 400 grit tape abrades wire.
Record tape length upon contact with conductor.
- ▷ RAYCHEM SPEC. SHT. "COMPARATIVE TEST DATA - RAYCHEM TYPE 88 AIRFRAME WIRE"
 1. Tape Abrasion: Test - 1.0 lb vert wt on wire 400 grit tape abrades wire. Record tape length upon contact with conductor.
 2. Scrape Abrasiion: Test - 2.25 lb load on 5 mil flat edge on 90°wedge moved back-and-forth, record cycles to fail.
 3. Cut-Through: Test - 5 mil flat on 90° wedge forced 0.2 in./min inot insul., record pounds to fail.
- ▷ McDAC RPT. MDC A0975 June 16, 1972
 1. Cut-Through Resistance: Ref. P.9; Test - 90° edge .010 radius blade applied 205 grams/sec.
- ▷ ALLIED CHEMICAL CORP. "HALAR FLUOROPOLYMER RESIN" May 1, 1972
 1. Chemical Resistance: See Page C-1 thru C-17
 2. Flame/Smoke: Test - See Pages F-1 thru F-6
- ▷ RAYCHEM PAPER "A NEW EXTRUDED ALKANE-IMIDE WIRE" LANZA & HALPERN ATLANTIC CITY Dec. 3, 196-
- ▷ DUPONT TEFZEL SPEC. SHT. APD #1 February 1, 1971
- ▷ McDAC RPT. MDC A0515
 1. Flex Life: Test plus/minus 90° over 1/8 mandrel
- ▷ DUPONT PAPER ON TEFZEL (STECCA, FASIG, CHEVRIER) ATLANTIC CITY December 3, 1970
- ▷ (Telecon) Ron Woloman, McDac/St Louis March 28, 1973
- ▷ ALLIED CHEMICAL CORP. DATA SHEET "HALAR - NEW GENERATION FLUOROPOLYMER"
- ▷ ALLIED CHEMICAL CORP. PAPER BY A. ROBERTSON & W. MIILLER "HALAR FLUOROPOLYMER - A VERSATILE INSULATION FOR WIRE"
- ▷ RAYCHEM DATA - LETTER - C. HAWKINS TO J. D. DOYLE "POLYARLENE TYPE 88B WIRE & CABLE" - 5-9---
- ▷ JSC/HOUSTON: TEST DATA AVAILABLE AT A LATER DATE
- ▷ ROCKWELL MEMO: INSULATION ABRASION TEST/H. L. PORTIOUS D/098-411 TO J.E. WELLS D/060 DATED 10-18-72
- ▷ ROCKWELL L&T REPORT NO. LR9931-901 DATED MAY 1973
- ▷ ROCKWELL IL 044-110-73-4-11, EVALUATION OF SPACE SHUTTLE WIRE TYPES
- ▷ ROCKWELL IL M3-053-JEB-1881, SHUTTLE WIRE EVALUATION

ORBITER WIRE USAGE

- **KAPTON IS PRIMARY WIRE USED ON ORBITER PROGRAM**
 - MIL SPEC 81381, RI SPEC MB0150-048
 - KAPTON PRIMARY INSULATION & OUTER JACKET
 - 26 TO "0" AWG SIZES USED
 - CURRENT CARRYING CHARACTERISTICS ESTABLISHED BY TEST, NASA-JSC, REPORT LEC-1756 & JSC-09156
- **TEFLON USED IN D&C PANELS & POWER & CONTROL ASSEMBLIES**
 - MIL SPEC 22759/12, RI SPEC MB0150-061
 - TFE TEFLON PRIMARY INSULATION
 - KAPTON OUTER JACKET
- **CONTROLLED IMPEDANCE USED FOR DATA BUS WIRE**
 - MIL SPEC 22759/23, RI MB0150-051
 - TFE TEFLON PRIMARY INSULATION
 - KAPTON OUTER JACKET
- **PFA USED FOR LARGE GAGE IN POWER & CONTROL ASSEMBLIES & EQUIPMENT BAYS**
 - MIL SPEC 22759, RI MB0150-062
 - PFA TEFLON PRIMARY INSULATION
- **MPS ENGINE CONTROLLER DATA BUS WIRE**
 - 40 M 50578B22-2SR

ORBITER WIRE USAGE PER VEHICLE

• ORBITER WIRE USAGE BY TYPE & LENGTH		
• KAPTON	- UNSHIELDED	577,900 FT.
	- SHIELDED	176,000 FT
	TOTAL	<u>753,900 FT</u>
• TEFLON	- UNSHIELDED	64,500 FT
	- SHIELDED	700 FT
	- PFA (LARGE GAGE)	1100 FT
• DATA BUS (2 CONDUCTOR SHIELDED)		<u>32,600 FT</u>
	TOTAL	98,900 FT
	GRAND TOTAL	852,800 FT
• VEHICLE WIRE SEGMENTS		83,000 SEGMENTS
• D&C PANELS & PWR & CONT. ASSY. WIRE SEGMENTS		<u>32,000 SEGMENTS</u>
	TOTAL SEGMENTS	115,000 SEGMENTS
• TOTAL VEHICLE WIRE WEIGHT (WITH CONNECTORS)		5,369 LBS
• DOES NOT INCLUDE D&C PANELS & PWR & CONT. ASSY'S.		

FABRICATION & TEST REQUIREMENTS

- **HARNES FABRICATION**
 - **ORBITER MOCKUP BUILT FOR WIRING & PLUMBING**
 - **FLIGHT DECK & EQUIPMENT BAY HARNESSES BUILT ON 3D TOOL**
 - **ALL OTHER HARNESSES BUILT ON FLAT BOARDS**
 - **MECHANICAL STRIPPERS USED FOR KAPTON INSULATION**
 - **SLEEVES USED TO MARK WIRES**
- **HARNES TEST REQUIREMENTS**
 - **CONTRACT REQUIRES CONTINUITY & 1500 VDC HIGH POTENTIAL TEST AFTER INSTALLATION**
 - **MANUFACTURING PERFORMS SAME TEST ON EACH HARNES PRIOR TO INSTALLATION**
 - **AFTER POWER ON TESTING CONTINUITY REQUIRED ON ALL REWORK**
 - **HIGH POTENTIAL TEST ON DATA BUS & PYRO FIRING CIRCUITS**

ORBITER WIRE INSTALLATIONS

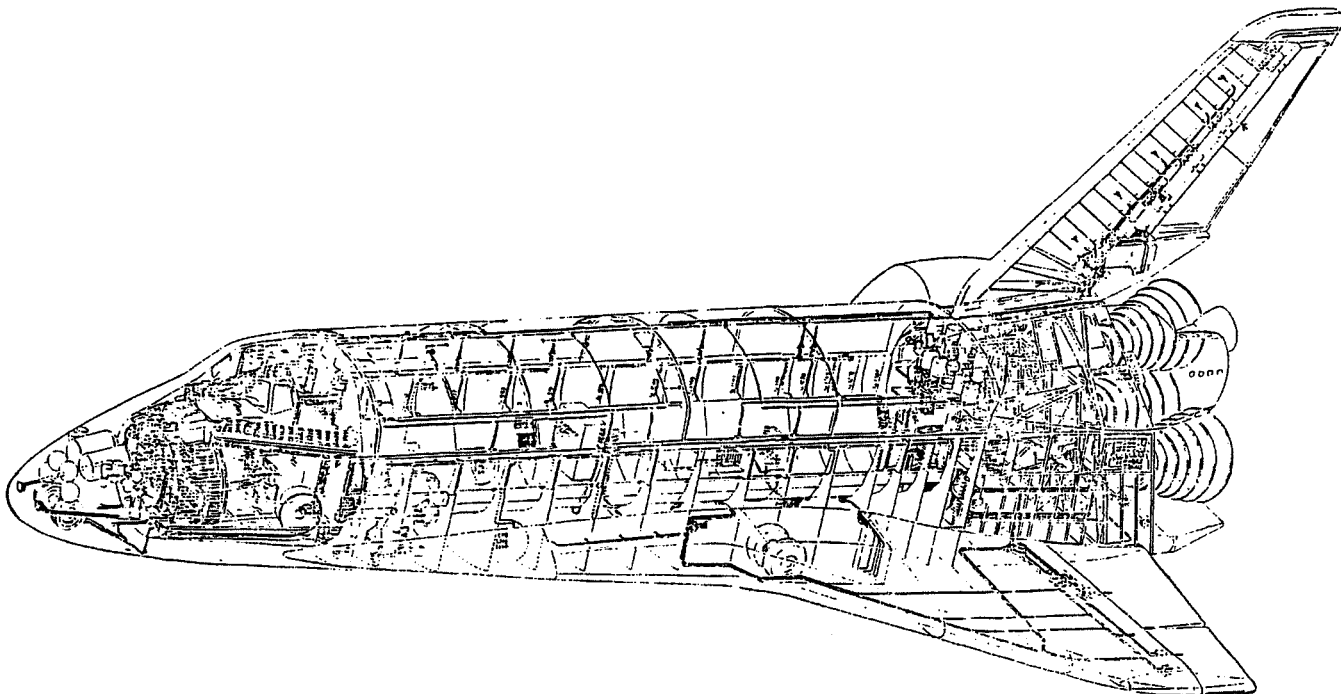

CREW MODULE WIRING INSTALLATION

- FLIGHT DECK WIRE CONGESTED DUE TO QUANTITY OF WIRING REQUIRED FOR DISPLAY & CONTROL PANELS
 - LARGE WIRE BUNDLES BEHIND SECONDARY STRUCTURE, D&C PANELS & CLOSE OUT PANELS
- MID DECK EQUIPMENT BAYS HAVE LARGE QUANTITY OF WIRES
 - ROUTED IN WIRE TRAYS IN FRONT OF LRU'S
 - COVERS INSTALLED OVER BAYS
- ENVIRONMENTAL CONTROL BAY CONGESTED WITH WIRE ROUTING FROM EQUIPMENT BAYS THRU PRESSURE BULKHEADS

AFT
FLIGHT
DECK
ON-ORB
STA
LKG AFT
LOWER
STOWAGE
AREA

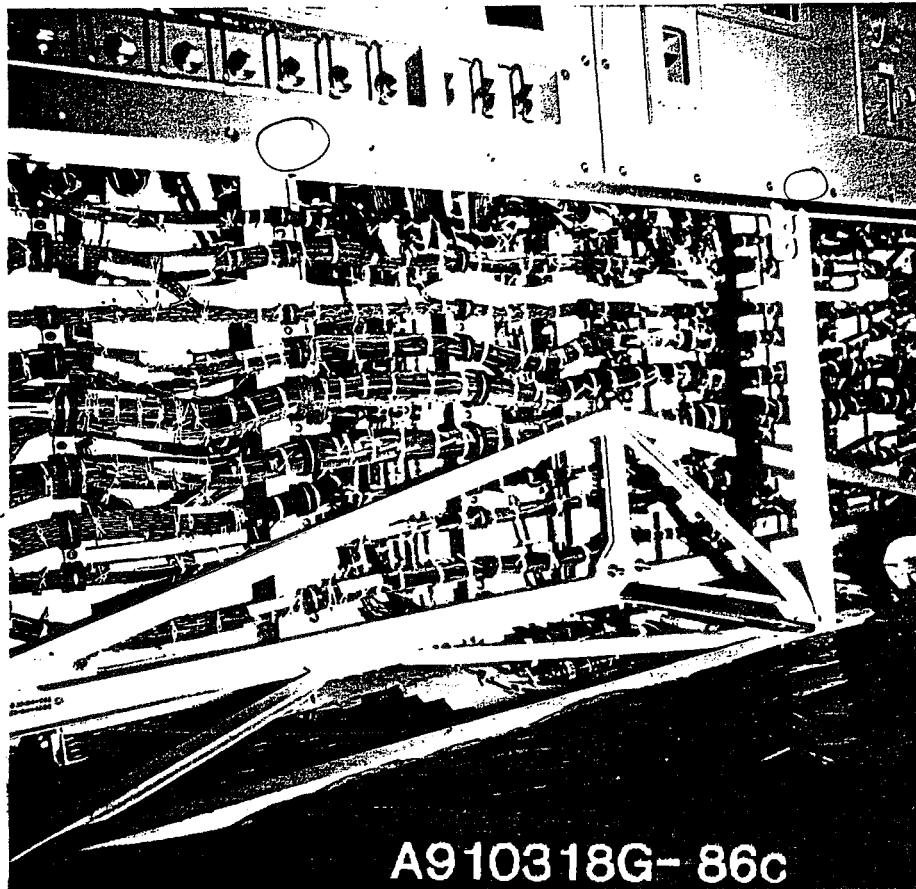

A910318G-86c

X0574
R.H.
SIDE

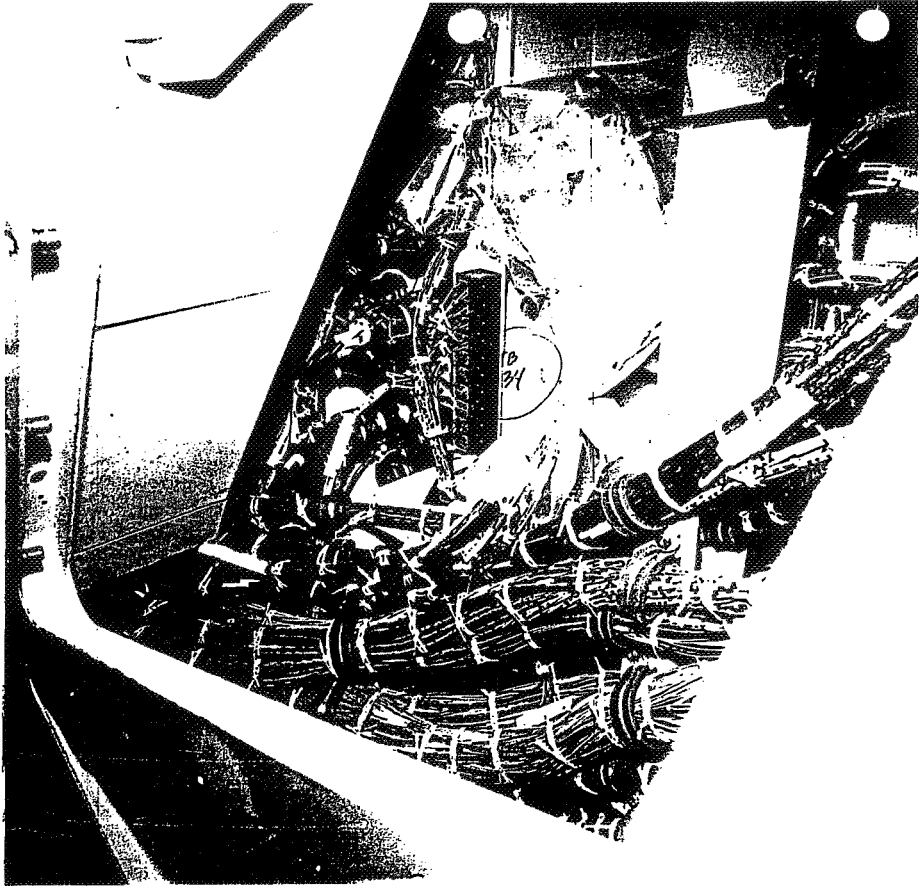

AVIONICS
BAY 1
LKG FWD
& OUTBD

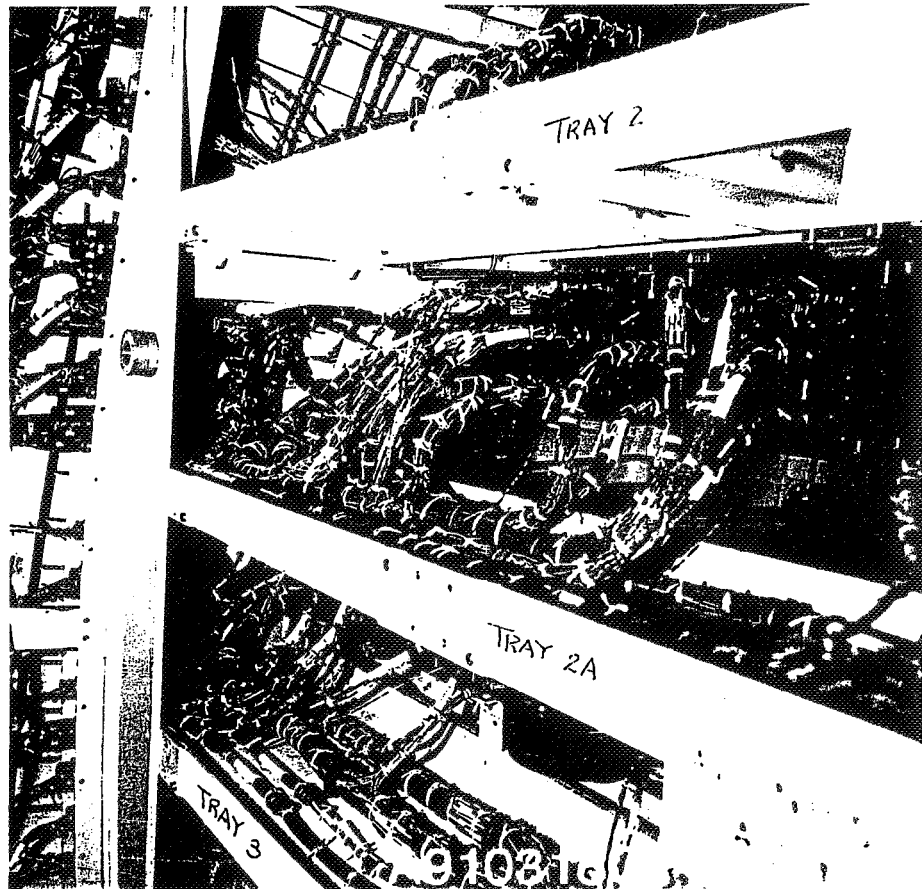

OV 108
ECSS
R.H.

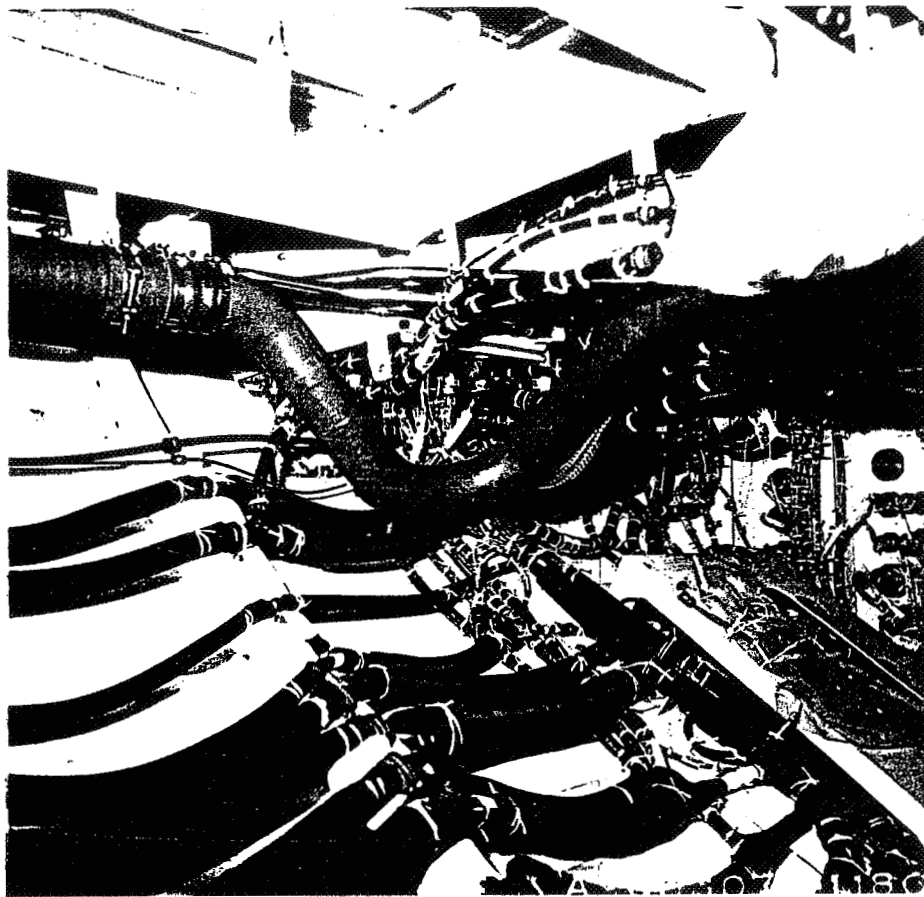

MID FUSELAGE WIRE INSTALLATIONS

- WIRE TRAYS WITH COVERS ON EACH SIDE OF MID FUSELAGE
- WIRING TO EQUIPMENT PROTECTED FROM TRAFFIC
 - LINER CLOSES OUT LOWER PORTION OF BAY.
 - WIRING FOR PAYLOADS ABOVE LINER
 - TEFLON BRAID ON ALL HARNESSSES FOR ADDED PROTECTION

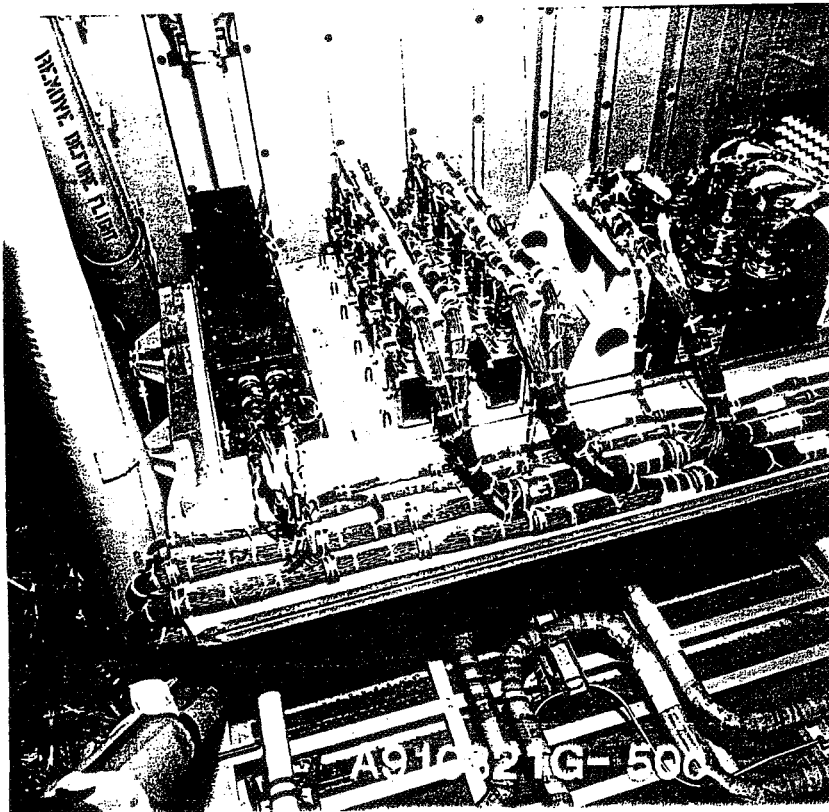
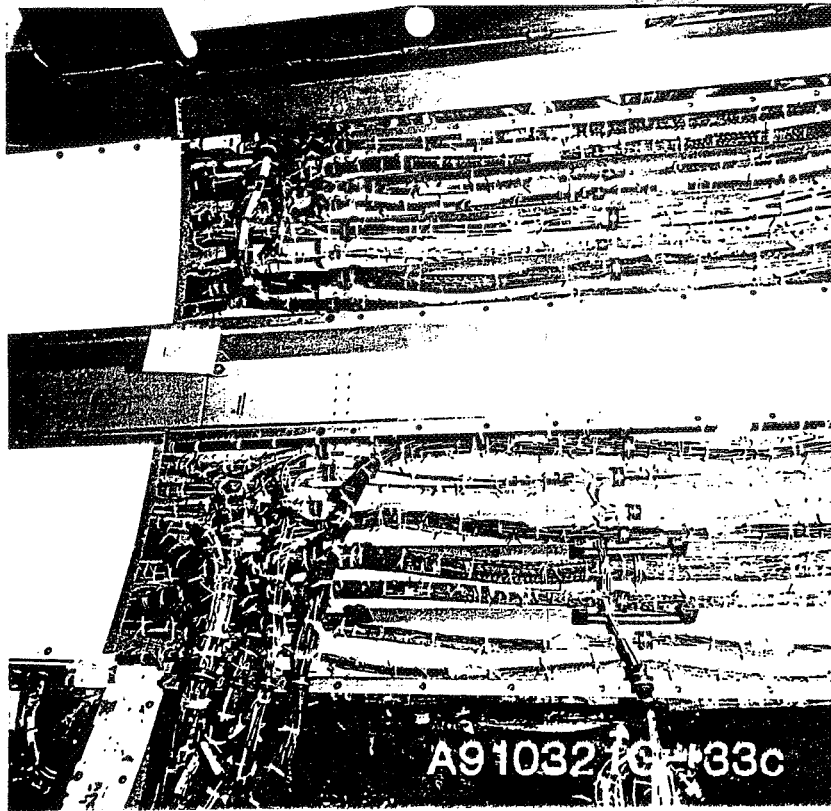

AFT FUSELAGE WIRE INSTALLATION

- **EQUIPMENT BAYS HAVE LARGE QUANTITY OF WIRES**
 - **WIRE TRAYS IN FRONT OF LRU'S**
 - **COVERS INSTALLED OVER BAYS**
- **AFT FUSELAGE WIRING ROUTED ON SIDE WALLS**
 - **PERMANENT COVERS & CONVOLUTED TUBING ADDED IN HIGH TRAFFIC AREAS**
 - **WIRE TRAYS ORIGINALLY PLANNED BUT DELETED DUE TO WEIGHT**
 - **WORK STANDS ADDED/REMOVED EACH FLOW FOR ACCESS TO EXTERNAL TANK INTERFACES**

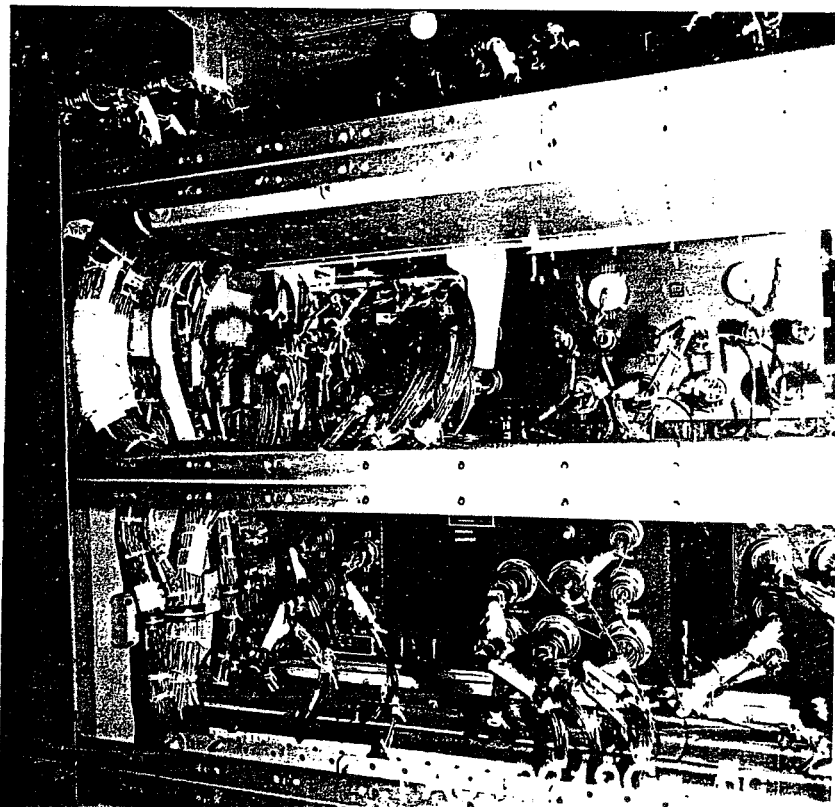

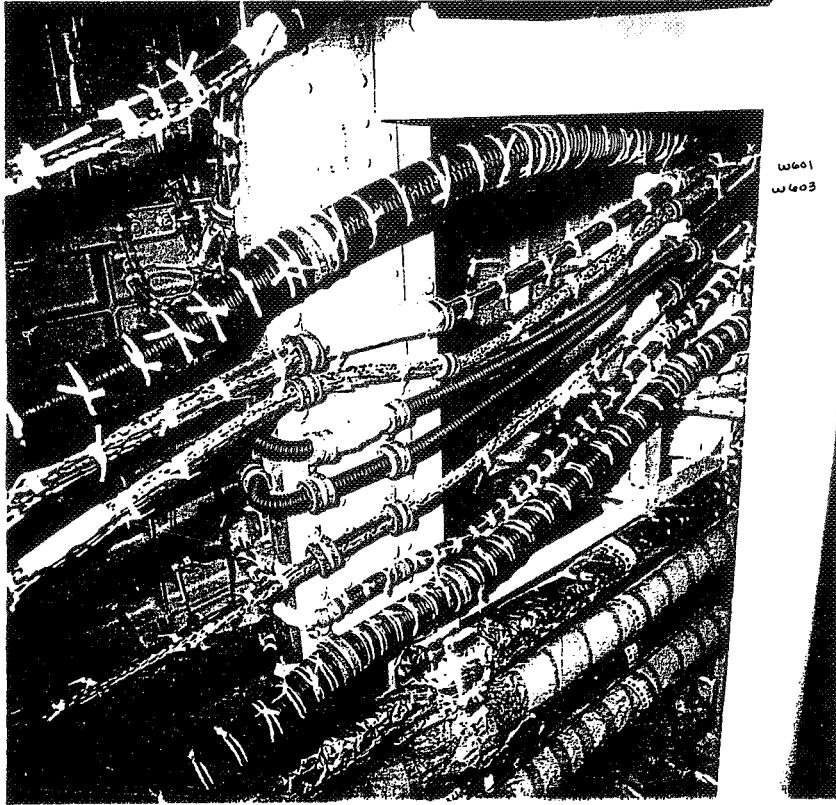

W601
W603

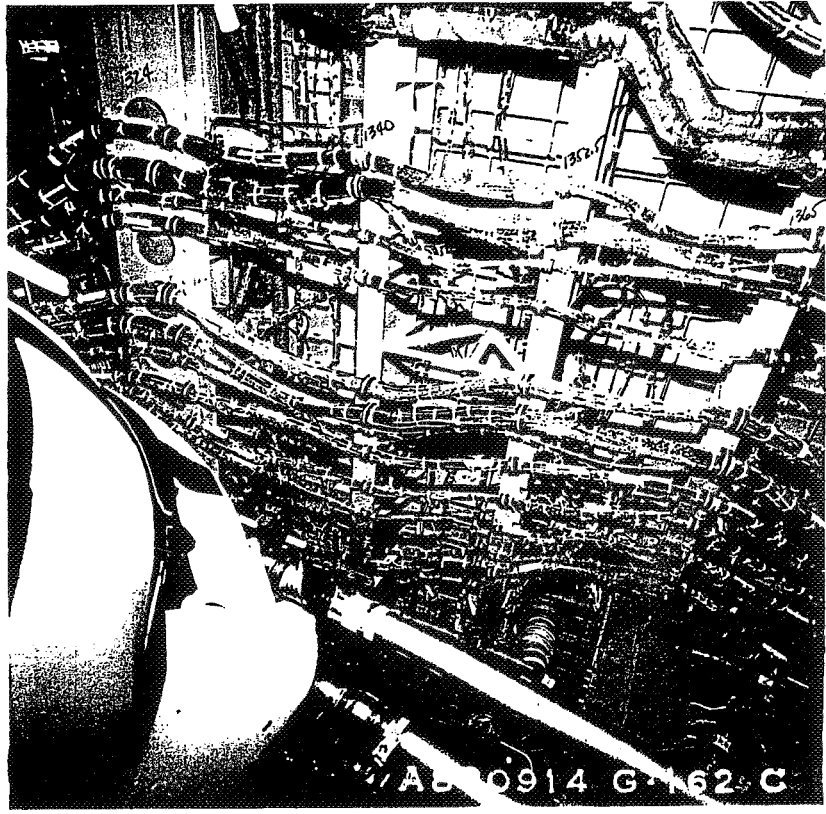

OV-103
PLM DL

A5 0914 G 162 C

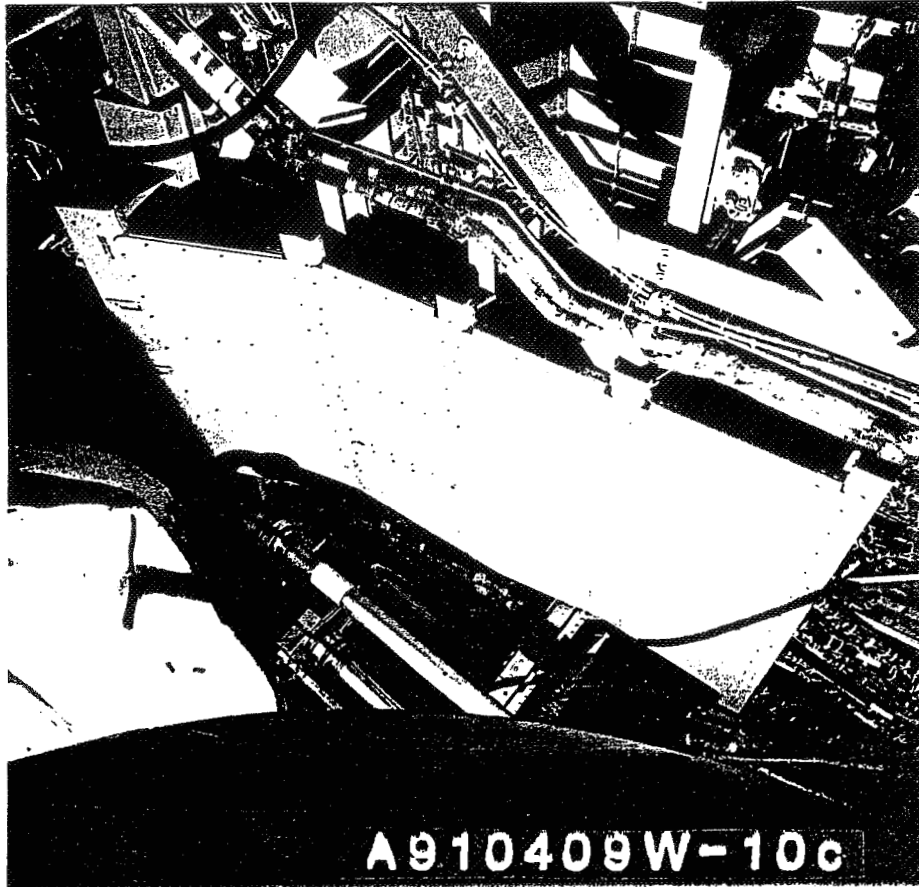

KAPTON WIRE EXPERIENCE

- **MANY ELECTRICAL SHORT CIRCUITS DUE TO INSULATION DAMAGE HAVE OCCURRED**
 - **PROTECTION DEVICES OPERATED AND INTERRUPTED FAULT CURRENT**
 - **ORBITER HAS EXPERIENCED TWO INSTANCES OF ARC TRACKING**
 - **OV-099 STS-6 HUMIDITY SEPARATOR WIRING**
 - **SIX CONDUCTORS MELTED THRU**
 - **ARCING INTERRUPTED BY FOUR CIRCUIT BREAKERS OPENING**
 - **CORRECTIVE ACTION PERFORMED TO VERIFY CLEARANCE OF ALL STORAGE CONTAINERS AND ADDITIONAL WIRE INSULATION PROTECTION INSTALLED**
 - **OV-102 STS-28 TELEPRINTER CABLE SHORT**
 - **ARC TRACKING OCCURRED FOR APPROXIMATELY 1.6 SECONDS UNTIL ARC EXTINGUISHED ITSELF AT BACK OF CONNECTOR**
 - **CIRCUIT BREAKER DID NOT OPEN**
 - **CORRECTIVE ACTION CHANGED HARNESS WIRES TO TEFLON INSULATION FOR GREATER FLEXIBILITY & USED 90° CONNECTOR AT PANEL INTERFACE**

KAPTON WIRE EXPERIENCE

- **VEHICLE INSPECTIONS CONDUCTED TO REVIEW CONDITION OF KAPTON WIRE**
 - **11/6/89 NASA HEADQUARTERS, NASA JSC, NASA KSC, ROCKWELL & LOCKHEED PERSONNEL REVIEWED THREE VEHICLES AT KSC BECAUSE OF ARC TRACKING CONCERNS**
 - **INSPECTION INDICATED ORBITER WIRING WAS GENERALLY IN GOOD SHAPE**
 - **4/9/91 NASA JSC, NASA KSC, ROCKWELL & LOCKHEED INSPECTED OV-102 AFT FUSELAGE - FIRST VEHICLE DELIVERED AND FABRICATION OF HARNESSSES STARTED IN 1977**
 - **OVERALL CONDITION OF WIRING WAS VERY GOOD**
 - **SOME TWO CONDUCTOR SHIELDED CABLES IN HIGH TRAFFIC AREAS HAD TOP COAT CRACKS/FRAYING**
 - **SAW WHERE DAMAGED WIRES HAD BEEN REPAIRED IN HIGH TRAFFIC AREAS**
- **FLUID SPILLS**
 - **FIRST TEST VEHICLE HAD A HYDRAZINE SPILL WHICH CAUSED KAPTON INSULATION TO DETERIORATE**
 - **HYDRAULIC FLUID HAS NOT AFFECTED INSULATION**
- **PROTECT AGAINST DAMAGE**
 - **INSPECTIONS DURING BUILD PHASE TO IDENTIFY AND PROTECT AREAS OF POTENTIAL DAMAGE**
 - **TECHNICIAN TRAINING HAS BEEN EXPANDED TO STRESS IMPORTANCE OF PREVENTING DAMAGE**
 - **WIRING IS INSPECTED FOR DAMAGE AS PART OF CLOSEOUT OF AREAS REQUIRING WORK DURING TURNAROUND**
 - **ORBITER DESIGN REQUIREMENT ROUTE CRITICAL FUNCTIONS IN SEPARATE HARNESSSES**
 - **PRECLUDES SINGLE HARNESS FAILURE FROM CREATING A SAFETY OF FLIGHT CONDITION**
 - **WIRE COVERS BEING ADDED IN HEAVY TRAFFIC AREAS OF AFT FUSELAGE**
 - **CONVOLUTED TUBING ADDED IN AREAS WHERE DAMAGE OR POTENTIAL FOR DAMAGE HAS BEEN IDENTIFIED**

NASA KAPTON WIRE TESTING

- **ARC TRACKING TESTS PERFORMED AT JSC IN THE ELECTRICAL POWER SYSTEMS LABORATORY**
- **TEST OBJECTIVES WERE:**
 - **OBTAIN DATA FROM TESTS PERFORMED ON KAPTON WIRE IN SIMULATED ORBITER CONFIGURATIONS**
 - **USE DATA TO ASSESS SAFETY OF ORBITER WIRE SYSTEM**
- **ARC TRACKING TESTS EVALUATED EFFECTS OF**
 - **WIRE SIZE/CONFIGURATION**
 - **ORBITER CIRCUIT PROTECTION DEVICES**
 - **AC/DC VOLTAGES**
 - **ARCING TO STRUCTURE**
 - **ELECTRICAL LOADING**
 - **INSTALLATION HARDWARE BUNDLING & ARC PROPAGATION**

RESULTS OF ARC TRACKING TEST

- **SUMMARY OF TESTS**
 - **CIRCUIT PROTECTION DEVICES, AS A RULE, DO NOT PROTECT AGAINST ARC TRACKING**
 - **RE-CLOSING OF TRIPPED CIRCUIT PROTECTION DEVICES REINITIATES ARC TRACKING**
 - **ARC TRACKING OF WIRE IN A BUNDLE CAUSES DAMAGE TO ADJACENT WIRING**
 - **THE HIGHER THE VOLTAGE, THE EASIER IT IS TO START ARC TRACKING**
 - **DISTANCE OF ARC TRAVEL APPEARS TO BE LESS BEFORE CIRCUIT PROTECTION OPENS**
 - **WIRE SIZE 4 AWG WOULD NOT TRACK**

TEST SET-UP FOR TWISTED PAIR TESTING

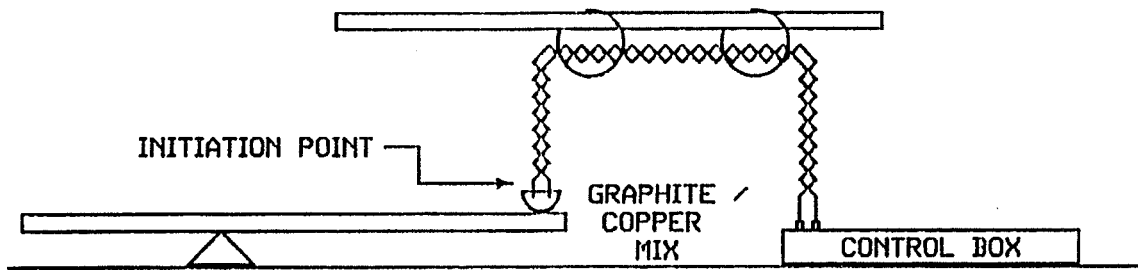

TEST SET-UP FOR TWISTED PAIR ELECTRICAL LOADING TESTING

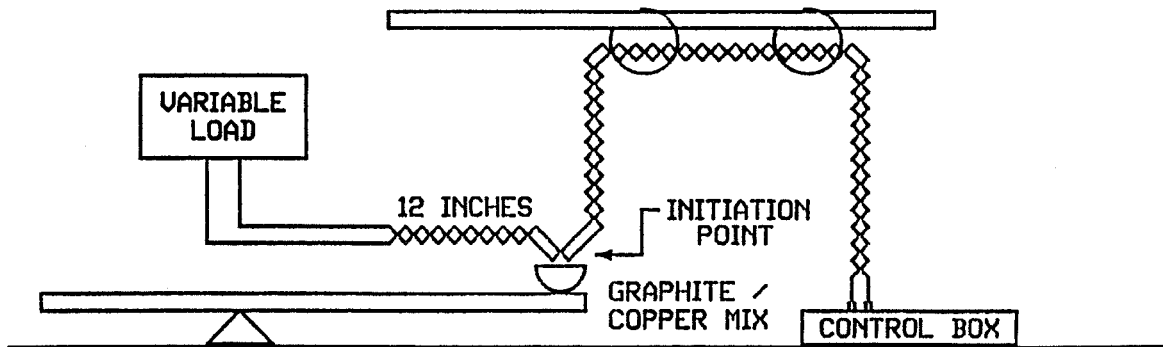

SUMMARY OF 28VDC ARC TRACK TESTS WITH PROPER SIZED CIRCUIT PROTECTION

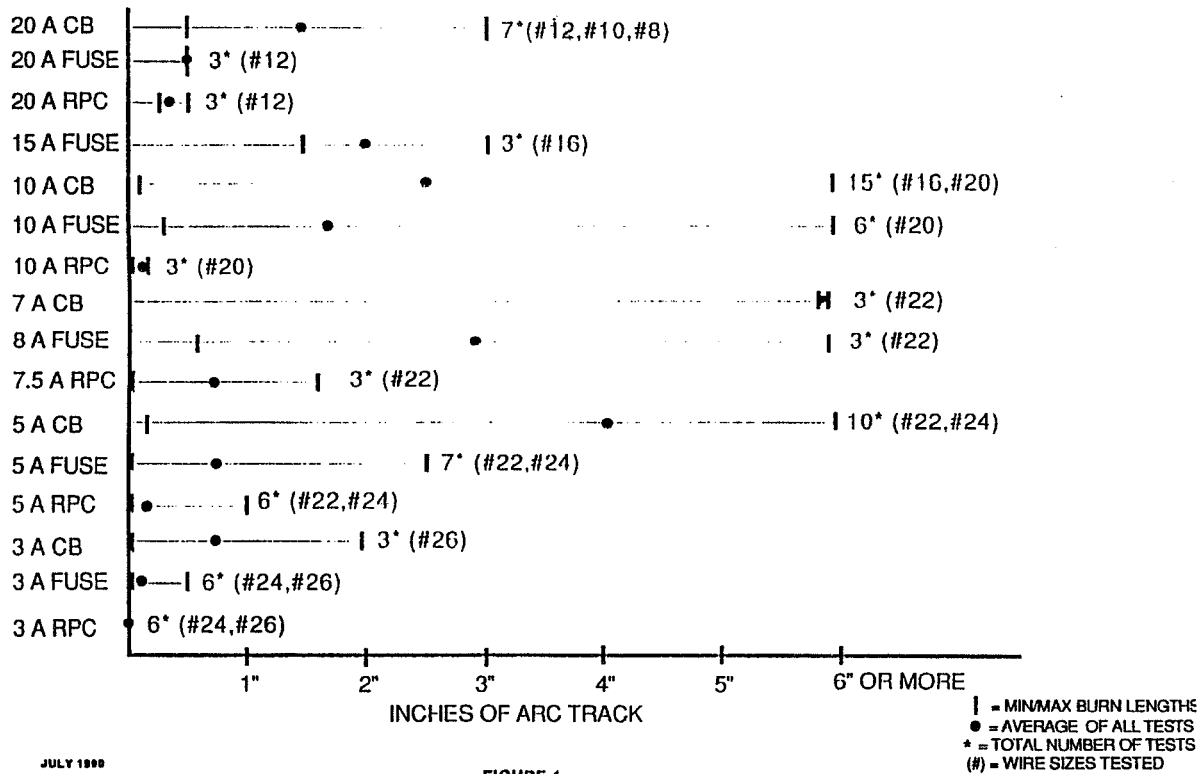

JULY 1999

FIGURE 1

SUMMARY OF 117VAC ARC TRACK TESTS WITH PROPER SIZED CIRCUIT PROTECTION

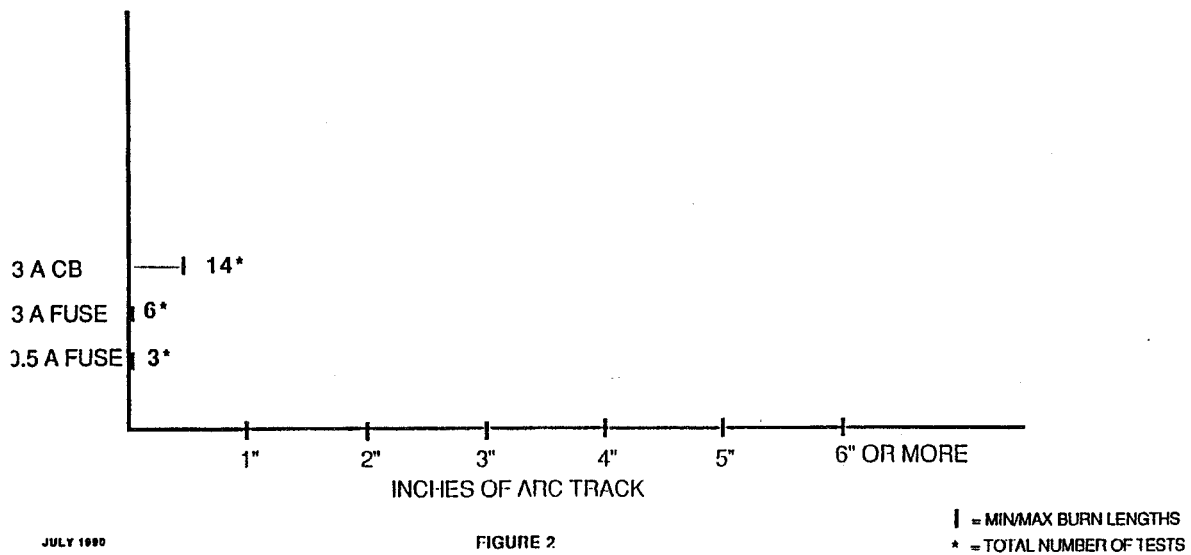

JULY 1999

FIGURE 2

SUMMARY

- INSPECTION OF FLEET SHOWS KAPTON WIRE IN GOOD CONDITION
 - FIRST SET OF HARNESS BUILT 1977
 - WIRE EXPOSED TO A RELATIVE BENIGN ENVIRONMENT
- TWO INSTANCES OF ARC TRACKING HAVE OCCURRED ON THE ORBITER
 - INSULATION MUST BE DAMAGED TO EXPOSE BARE CONDUCTORS
 - PROTECTIVE DEVICES LIMIT DURATION & EXTENT OF ARC TRACKING
- EXPOSED WIRING IN HIGH TRAFFIC AREAS HAS RESULTED IN NUMEROUS INSULATION DAMAGE
 - ON AN AVERAGE ONE SHORT CIRCUIT PER TURNAROUND HAS BEEN OCCURRING
 - EMPHASIS IS PLACED ON PREVENTING/LOCATING WIRE INSULATION DAMAGE
 - PHYSICAL PROTECTION
 - TECHNICIAN TRAINING
 - INSPECTION

BACK UP

1500 VDC HIGH POTENTIAL TEST REQUIREMENTS 10/4/89 CONTRACTOR FURNISHED HARNESES

REQUIREMENT	ORBITER		MISSION EQUIPMENT		PAYLOADS	
	BENCH	INSTALLATION	BENCH	INSTALLATION	BENCH	INSTALLATION
• OVEI MJ070-0001-1C(JSC8080)		X		X		
• SEISMJ073-0001B(JSC8080)						X
• ROCKWELL SPECIFICATION ML0201-0003	1*	2	1	2	1 & 3	
• OMRSD FILE II VOLUME I S00 GEN. 410 (REWORK AND/OR REPAIR)		4				
• OMRSD FILE II VOLUME IV S0712A.717 (PAYLOAD & MISSION EQUIPMENT)			5		5	

* NUMBERS REFER TO TEST REQUIREMENTS EXPLANATION

1500 VDC HIGH POTENTIAL TEST REQUIREMENTS 10/4/89

1. SPECIFICATION STATES BENCH LEVEL TEST IS OPTIONAL EXCEPT FOR OPERATIONAL SPARE WIRES WHICH IS MANDATORY PRIOR TO INSTALLATION. MANUFACTURING HAS CHOSEN TO TEST ALL HARNESSSES AT THE BENCH LEVEL.
2. SPECIFICATION STATES TEST MANDATORY AFTER INSTALLATION. AFTER POWER ON TEST IT IS MANDATORY THAT TEST BE RUN ON ALL REWORKED DATA BUS, CONTROLLED IMPEDANCE, AND PYRO FIRING WIRES. SOME MISSION EQUIPMENT HARNESSSES ARE INSTALLED DURING ORBITER ASSEMBLY AND NEVER REMOVED.
3. TEFLON WIRE USED FOR HARNESSSES AND MID FUSELAGE HARNESSSES HAVE AN OVERBRAID WHICH REQUIRE HIGH POTENTIAL TEST PRIOR TO AND AFTER BRAIDING.
4. TEST REQUIRED ON REWORKED AND/OR REPAIRED WIRES IS LIMITED TO DATA BUS CABLES, CONTROLLED IMPEDANCE CABLES AND PYRO FIRING WIRES OR CABLES.
5. TEST REQUIRED ON ALL PAYLOAD RELATED KITS. LOCKHEED (SPC) HAS REOCCURRING DOCUMENT OMI V1199 THAT REQUIRES TEST TO BE RUN AT KITTING FACILITY PRIOR TO EACH INSTALLATION.

COMPARISON OF TEFZEL, TEFLON AND KAPTON

	XL-ETFE	TFE	KAPTON
CUT-THROUGH RESISTANCE	GOOD	FAIR	EXCELLENT
ABRASION RESISTANCE	EXCELLENT	FAIR	EXCELLENT
FLEXIBILITY/ HANDLING	GOOD	EXCELLENT	POOR
ARC-TRACKING RESISTANCE	EXCELLENT	EXCELLENT	POOR
WEIGHT	GOOD	FAIR	EXCELLENT
MOISTURE RESISTANCE	EXCELLENT	EXCELLENT	GOOD
COLD-FLOW RESISTANCE	GOOD	FAIR	EXCELLENT
TEMPERATURE RANGE	GOOD	EXCELLENT	EXCELLENT
OUTGASSING	EXCELLENT	EXCELLENT	EXCELLENT
FLAMABILITY	GOOD	EXCELLENT	EXCELLENT
COLORABILITY	EXCELLENT	EXCELLENT	POOR

TYPICAL COSMETIC WIRE DAMAGE FOUND DURING 4/91 REVIEW OF OV-102

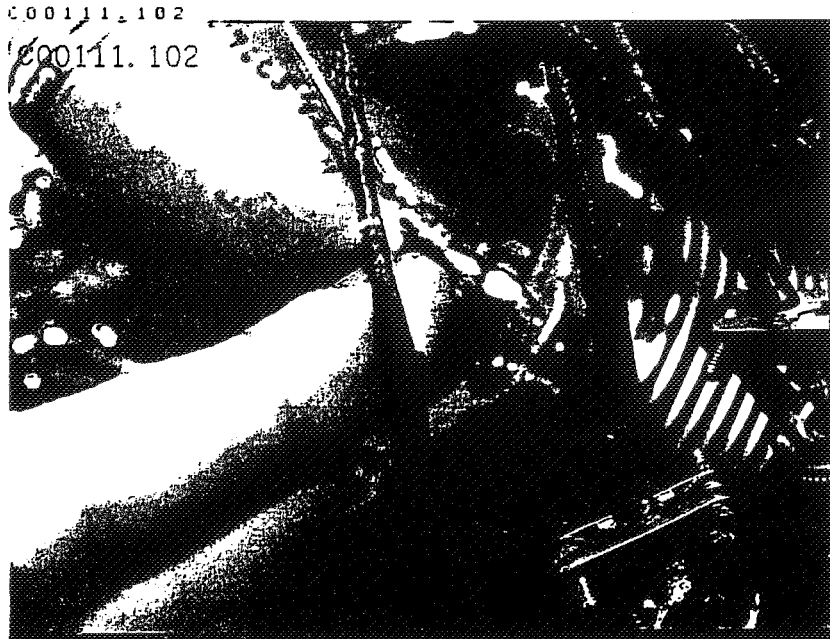
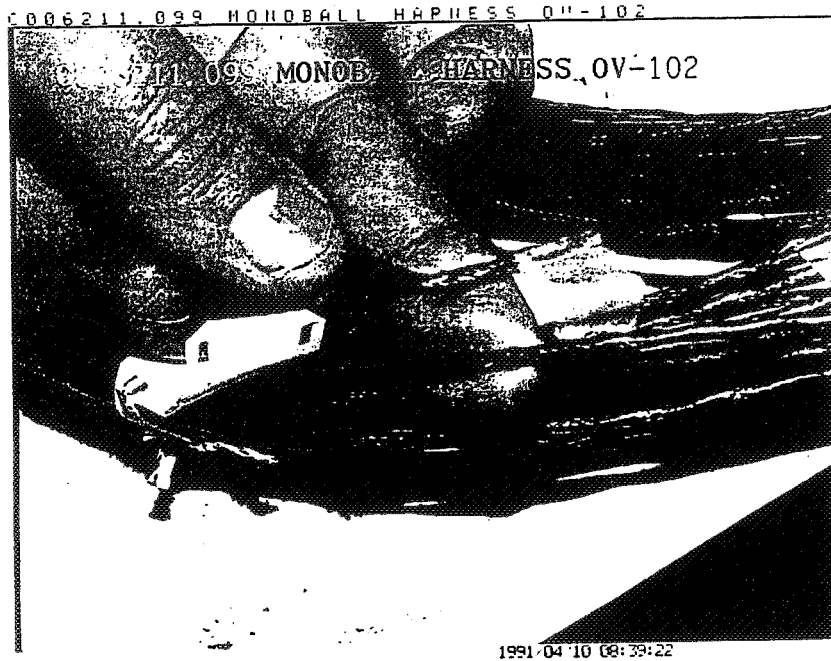

TYPICAL COSMETIC WIRE DAMAGE FOUND DURING 4/91 REVIEW OF OV-102

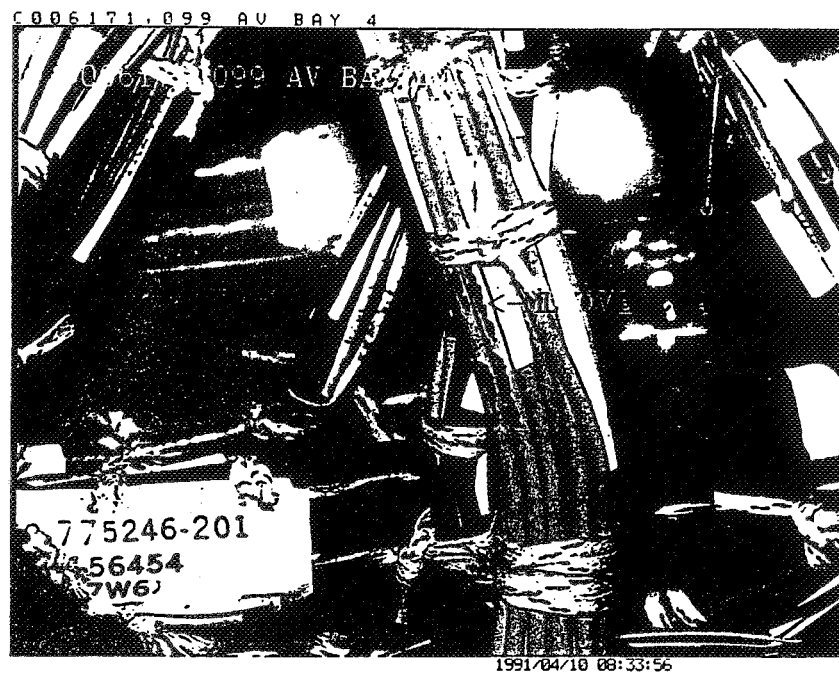
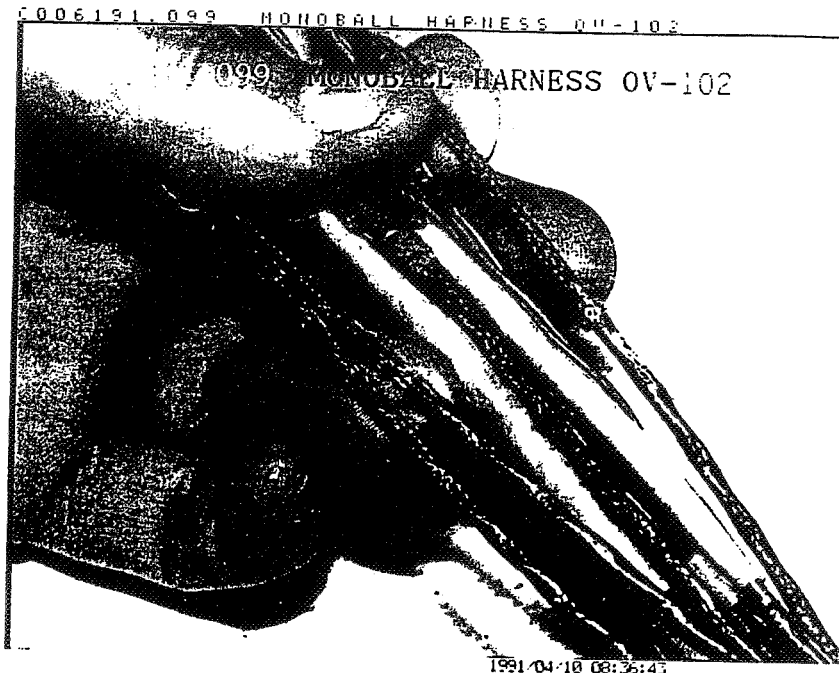

OV-099, STS-26 HUMIDITY SEPARATOR
DAMAGED WIRING

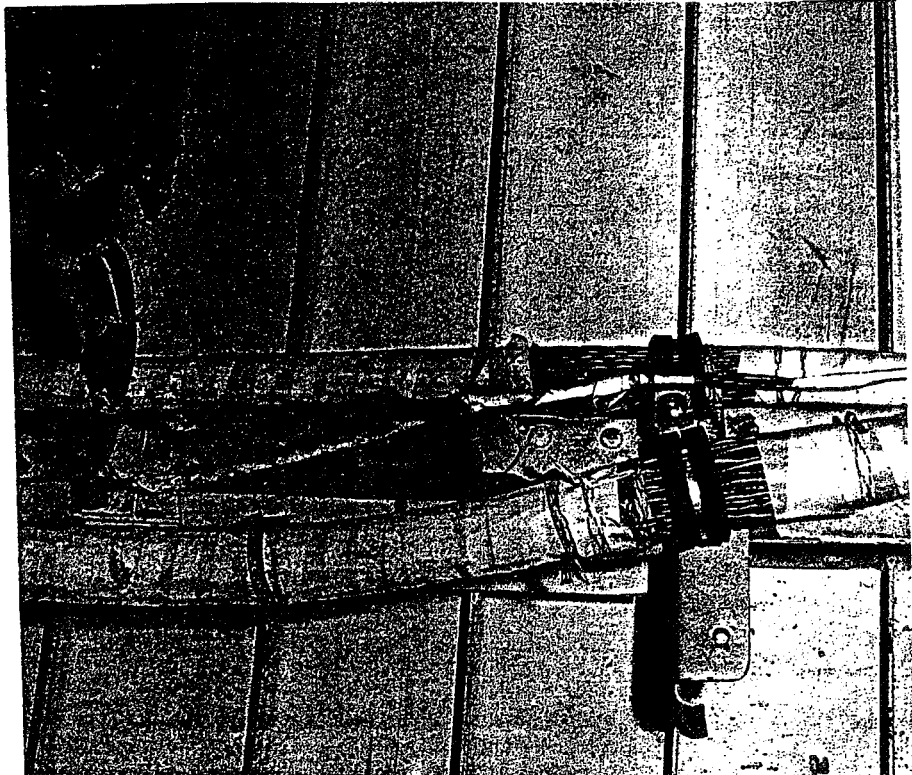

#1 MOTOR WIRE

↑
10X

N95- 16047

WSTF Electrical Arc Projects

30139
P. 18
109652
352963

Larry Linley
NASA Johnson Space Center
White Sands Test Facility (WSTF)

NHB 8060.1C Test 18 Validation

Objective

Validate Method Used To Screen Wire Insulation With Arc Tracking Characteristics

Approach

**7-wire bundle
Worst Case Power 200 VAC 25 Amps 400 Hz
Induce Failure with Graphite Powder (5 sec)
Remove Power (10 sec)
Restrike (30 sec)**

Failure

Propagation

Validation

**PTFE, ETFE, Polyimide
Ambient Air
Shuttle Environments**

PRECEDING PAGE BLANK NOT FILMED

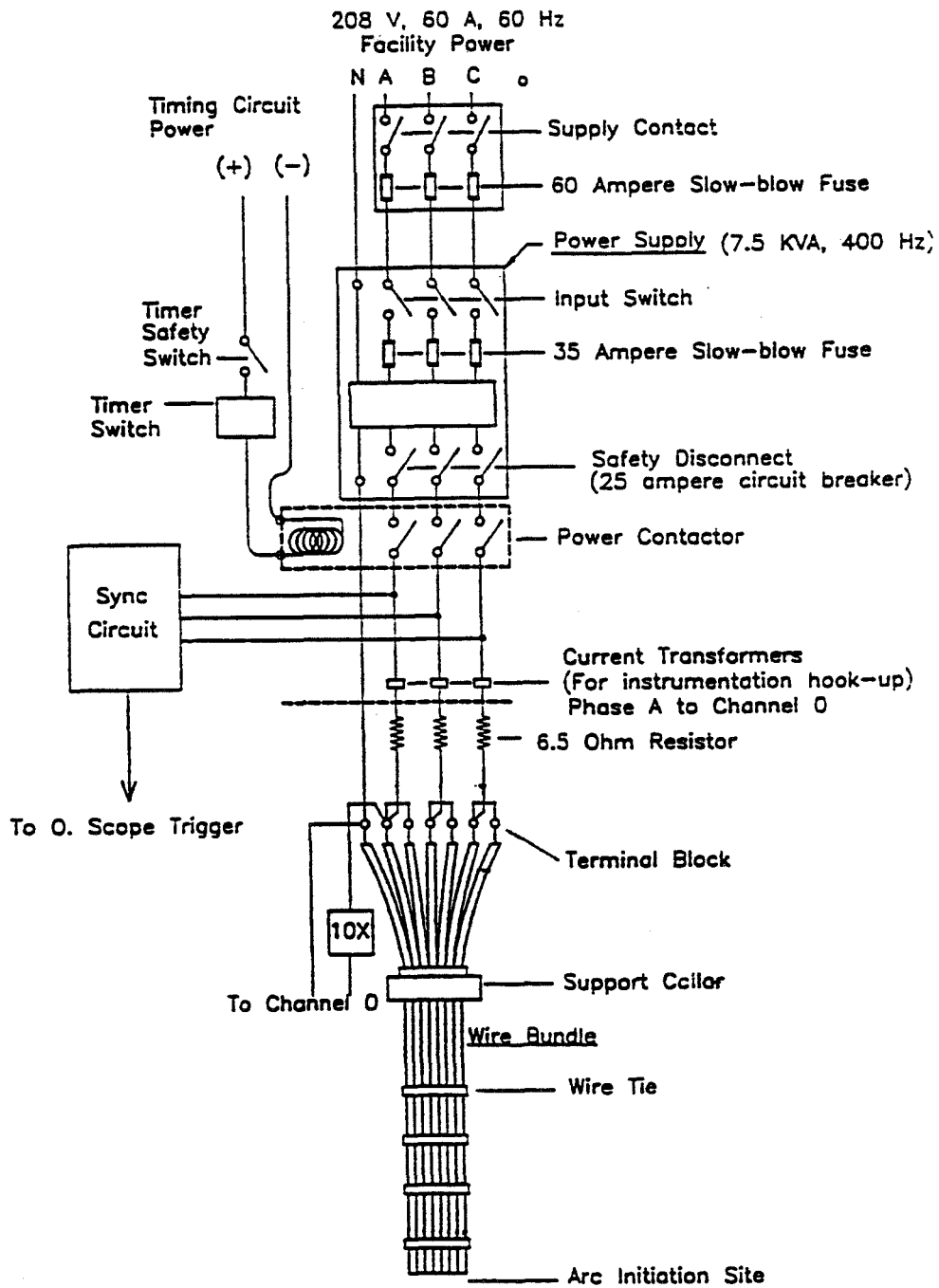

Functional Schematic of Test System Used to Validate NHB 8060.1C, Test 18

Arc Resistance In Space Grade Wires

Objective

Determine Damage Resistance to Arc as A Function of Source Voltage and Insulation Thickness

Approach

7-wire bundle
Power Source Voltage 28 to 300 VDC
Induce Brief (100 msec) Failure With Bridge Wire and Constant Current Source
Allow Normal Propagation With Power Source Voltage
Dielectric Measurement Between All Wires Insitu
Dielectric Evaluation of Each Wire
Visual Inspection

Analysis

Plot Wires Failed on Source Voltage vs Insulation Thickness

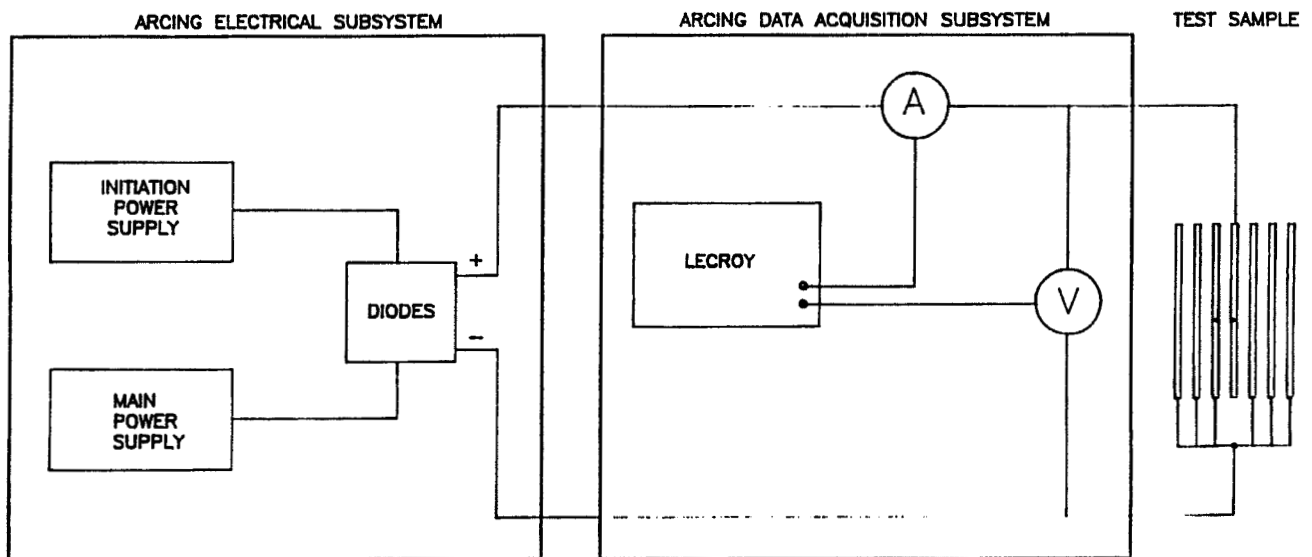

Pyrolytic and Arc Damage Properties of Kapton at Low Voltages

Objective

Investigate Propagation Characteristics of Kapton at Low Voltages

An Evaluation of the Pyrolytic and Arc-Damage Properties of Polyimide Wire Insulation for Low-Voltage Applications

Objective

Investigate Pyrolytic Properties of Polyimide Insulated (Kapton) Wire for Low Voltage (<35 VDC) Applications

Approach

- Measure pyrolytic threshold temperature of Kapton via thermogravimetric analysis
- Measure electrical resistance of pyrolyzed Kapton material (arc induced damage) as a function of arc exposure time
- Measure pyrolytic threshold and propagation rates for energized conductor pairs as a function of voltage and power for 20 & 26 AWG wires
- Assess damage to the insulation of wire adjacent to energized pyrolyzing wires
- Investigate spectral characteristics of the radiative emissions associated with the pyrolytic process as a function of applied voltage
- Develop and evaluate a theoretical model for predicting pyrolytic temperatures as a function of applied electrical power and wire size

Thermogravimetric Test

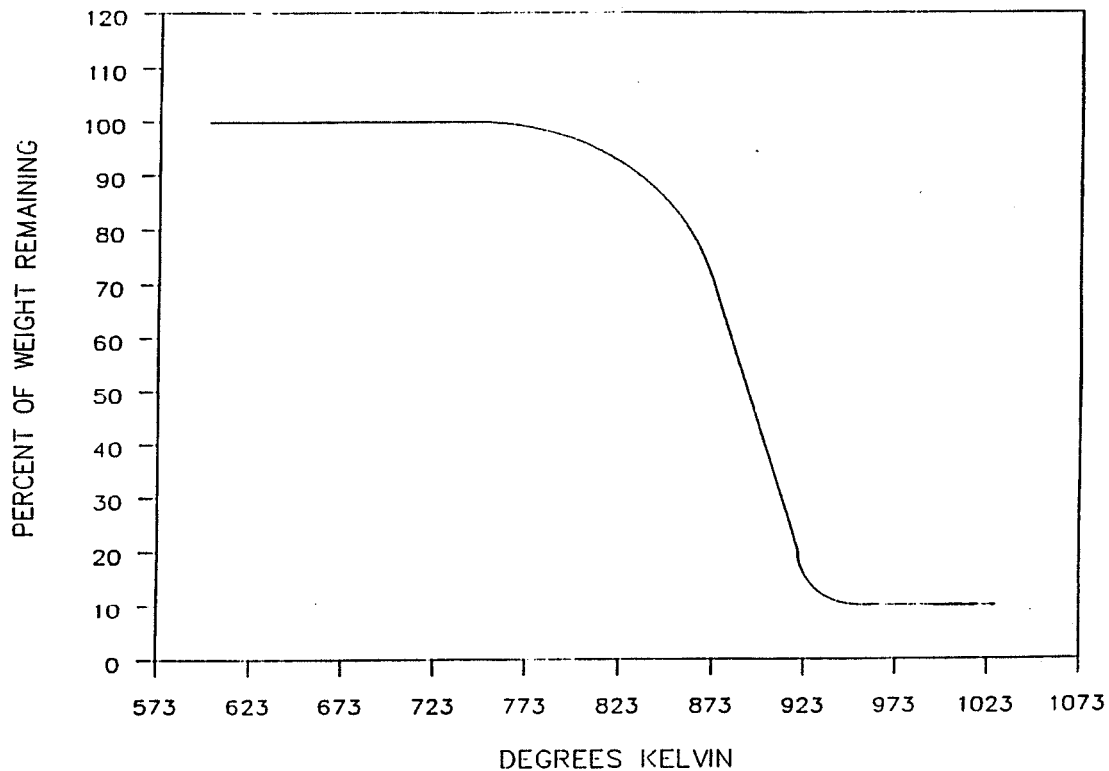

Thermogravimetric Analysis Procedures

A sample of the polyimide insulation was placed on a small tray. The tray was suspended by a microbalance and placed inside of a small oven contained within an Omnitherm 1500 TGA test system. A quartz tube surrounding the sample was placed inside the oven and attached to the top of the Omnitherm 1500. The top contains a seal through which the microbalance suspension passed into the oven. The maximum temperature (1023 K), rate of temperature increase (5 K/min), and flow rate of dry air through the oven (4 cc/sec) were then set at the control panel. As the temperature increased, the sample reacted with the air flowing through the oven and the weight was recorded by a computer attached to the Omnitherm 1500.

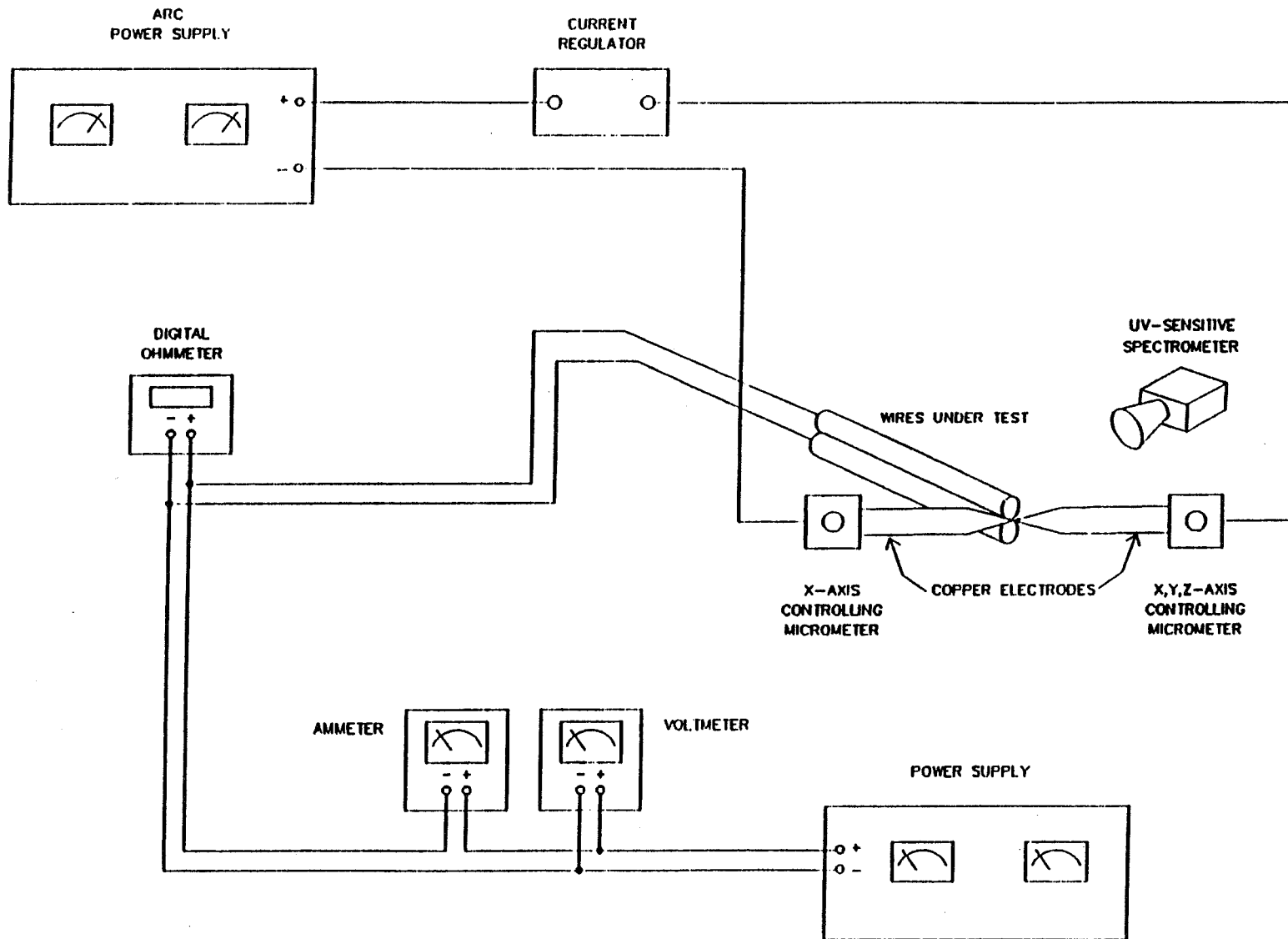

$$e_a = a + bx + \frac{c}{i} + \frac{dx}{i}$$

where

- e_a = voltage required to sustain the arc at 100 kPa (1 atm) at currents less than 18 A
- a, b, c, d = constants for copper electrodes (15.2, 10.7, 21.4, and 3.0, respectively)
- x = gap distance in mm
- i = arc current

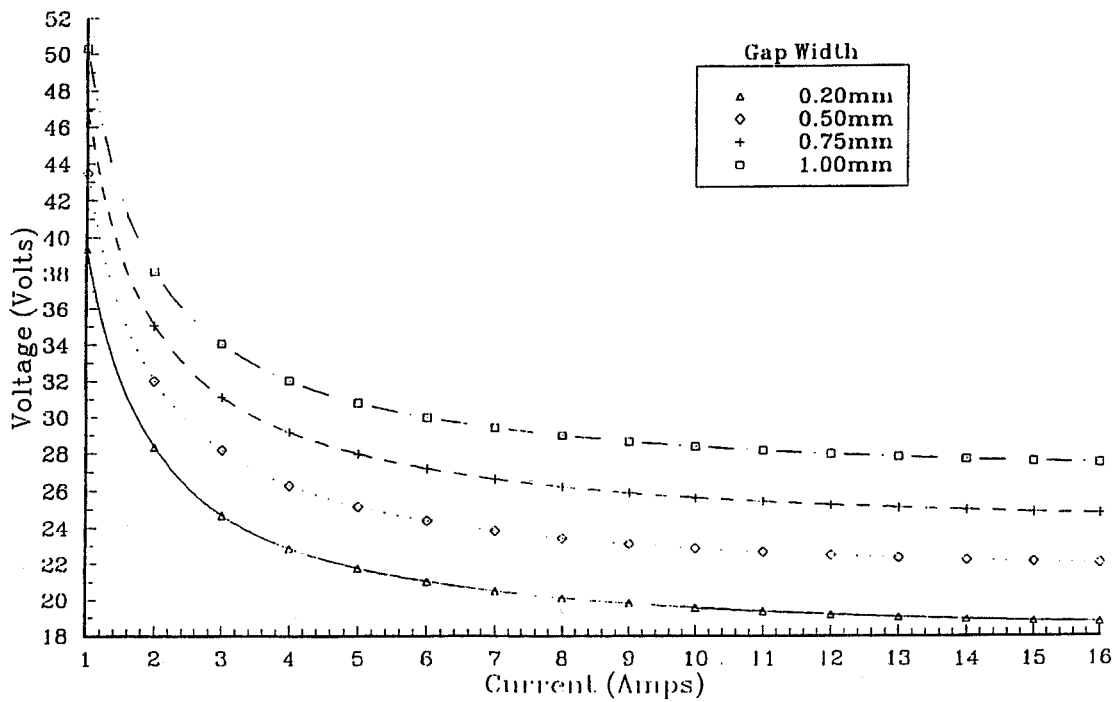

Table 1
Resistance Measurements After Arcs and After Power Application

Resistance (Ω) Measured After			Power (Volts, Amps)	After Power Applied	
2-sec Arc	5-sec Arc	10-sec Arc		Activity	Resistance (Ω)
20 AWG Wire					
∞^a	∞	128	28, 4	Sparks	1000
∞	1,400	115	28, 4	Nothing	∞
∞	∞	19,000	28, 4	Nothing	∞
∞	∞	7	28, 4	Pyrolysis	3
∞	∞	546	28, 4	Nothing	∞
∞	28,000	14	28, 4	Sparks	∞
∞	105	2	28, 4	Pyrolysis	2
∞	∞	2000	28, 4	Nothing	∞
∞	870,000	5	28, 4	Pyrolysis	5
∞	∞	8	28, 4	Pyrolysis	1
∞	∞	15	5, 5	Nothing	23
∞	10,000	20	5, 5	Nothing	410
∞	∞	30	5, 5	Nothing	14,000
∞	∞	4	5, 5	Nothing	5,000,000
∞	8,500	50	5, 5	Nothing	10,000,000
26 AWG Wire					
∞	∞	18	28, 4	Sparks	3500
∞	∞	570	28, 4	Nothing	∞
∞	∞	14	28, 4	Sparks	724,000
∞	240	113	28, 4	Sparks	11,000,000
∞	∞	30	28, 4	Sparks	5,800,000
∞	37	43	5, 5	Nothing	18,000
∞	∞	30	5, 5	Nothing	123
∞	39	7	5, 5	Sparks	1500
∞	∞	190	5, 5	Nothing	∞
∞	∞	25	5, 5	Nothing	136

^a ∞ : Greater than 12,000,000 Ω

Drawn Arc Test Procedures

Fifteen sets of 20 AWG and 10 sets of 26 AWG polyimide-insulated wire pairs (15-cm [6.0 in.] long) were constructed. Each pair was held together with common sewing thread to simulate a parallel wire bundle configuration.¹ Each wire pair was positioned horizontally in a metal clamp attached to a metal stand.

- The ends of the wire insulation were exposed to the drawn arc for 2 seconds.
- The resistance of the pyrolyzed polyimide insulation between the two wires was measured and recorded.
- The drawn arc and resistance measurements were repeated with arcs of 5 and 10 seconds.
- A power supply limited to 28 V open circuit and 4 A short circuit was applied for 1 minute to the wires and any pyrolytic activity was noted.
- The resistance of the pyrolyzed polyimide insulation was measured again after the power supply was turned off.

This same sequence of testing was conducted with the power supply limited to 5 V open circuit and 5 A short circuit.

After all the drawn arc testing was completed, an arc was drawn in the field of view of the UV-sensitive spectrometer to record the arc emissions.

¹Previous testing at WSTF determined that nylon lacing cord acted as a "fire-break" and greatly inhibited propagating pyrolysis.

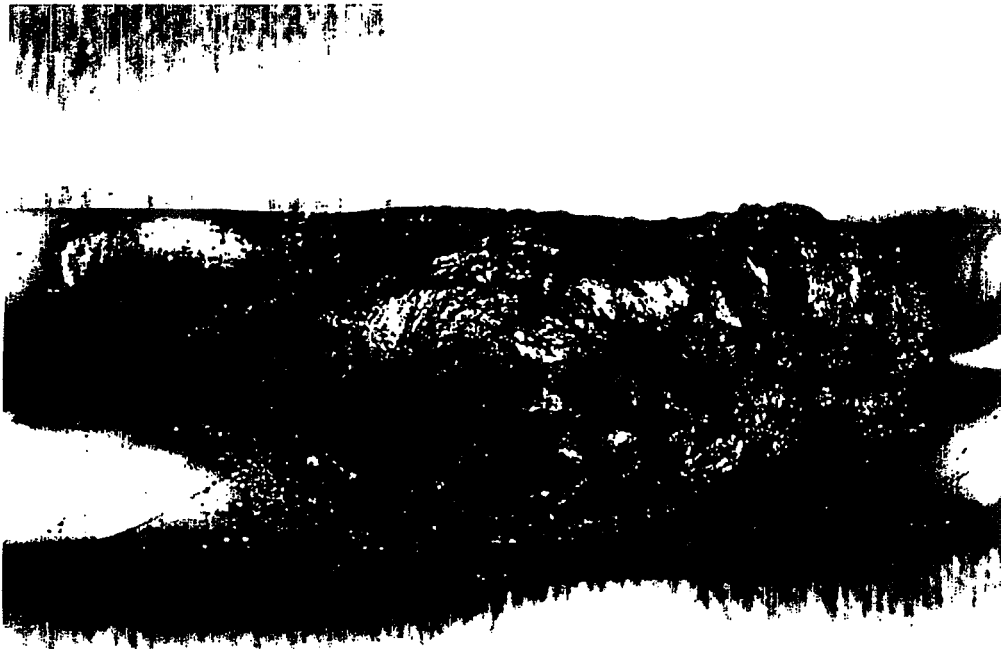

20 AWG Polyimide-Insulated Wire after 10 Seconds in Drawn Arc Test

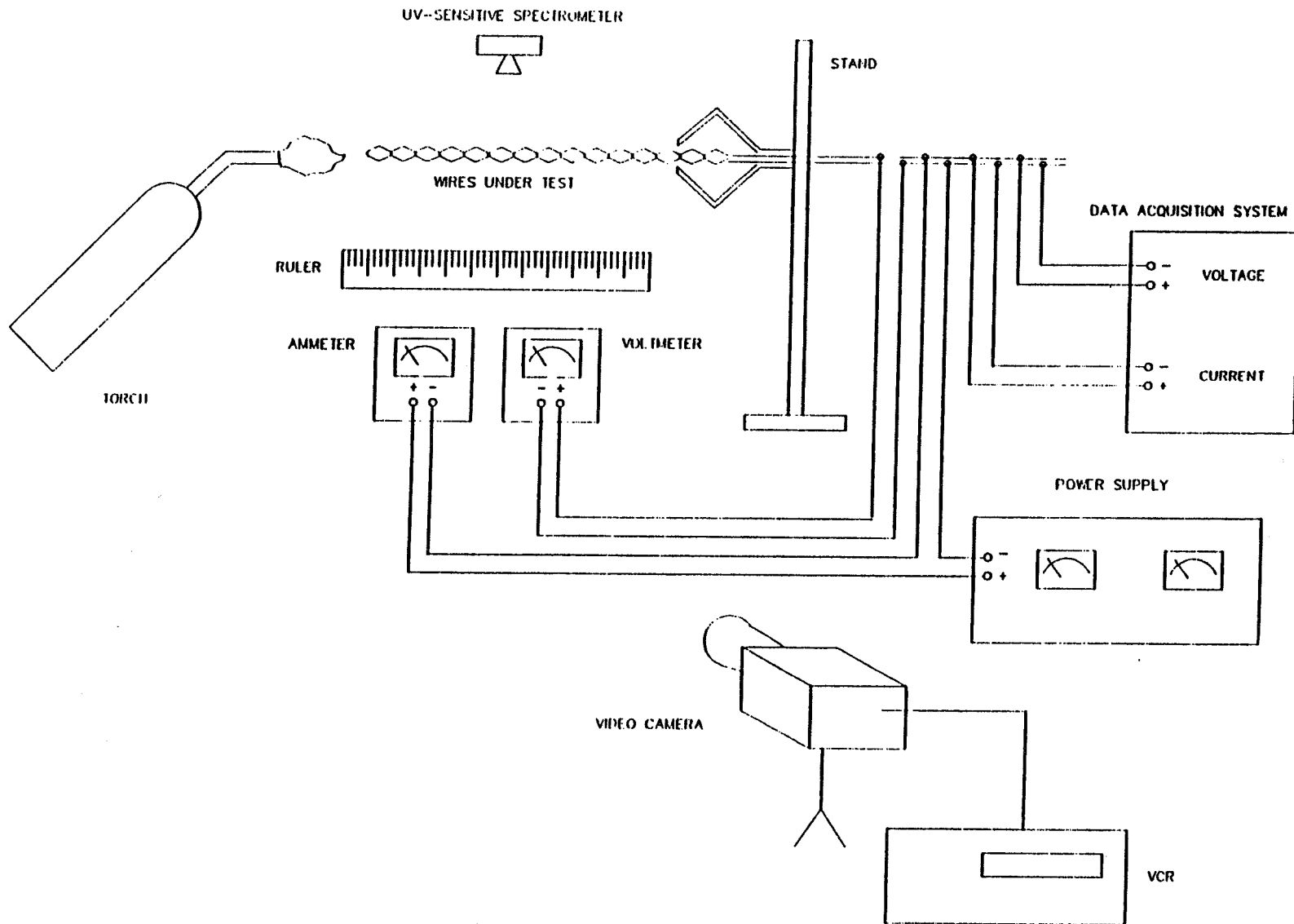

Energized Conductor

Energized Conductor Test Procedures

Twenty sets of both 20 and 26 AWG twisted pair, open circuit, polyimide-insulated wires (36-cm [14-in.] long) were constructed. Each wire pair was positioned horizontally in a metal clamp attached to a metal stand. Power supply, data acquisition system, and meter connections were made at the ends of the wires held in place by the metal clamp. A ruler was placed under the wires (to facilitate the measurement of the propagating-pyrolysis rate) and the video system was activated.

- The power supply, limited to 28 V open circuit and 4 A short circuit and connected to the ends of the wires, was energized. Approximate electrical power values necessary to sustain pyrolysis, along with propagating-pyrolysis rates, were recorded with the analog meters and video system. More accurate electrical power values were recorded with the data acquisition system to verify the analog meter readings.
- After sustained pyrolysis was obtained, the power supply current limit was decreased (to 2 A for the 20 AWG wires and to 1 A for the 26 AWG wires), and then increased in 1 A/min increments up to 10 A.

Table 2
Propagating-Pyrolysis Rate of 20 AWG

Voltage (Volts)	Current (Amps)	Power (Watts)	Propagation Rate	
			(cm/min)	(in./min)
5.3	1.9	10.0	0.5	0.2
4.5	2.9	13.1	0.8	0.3
3.6	4.0	14.4	1	0.4
4.3	4.8	20.6	1	0.5
3.8	5.9	22.4	2	0.9
4.3	6.8	29.2	3.8	1.5
4.3	7.8	33.5	4.3	1.7
4.0	8.9	35.6	6.4	2.5
3.8	9.9	37.6	10	3.8
4	20.0	80.0	25	10
4	24.0	96.0	30	12
16	15.0	240.0	76	30
24	12.0	288.0	76	30
28	11.0	308.0	76	30

Table 3
Propagating-Pyrolysis Rate of 26 AWG

Voltage (Volts)	Current (Amps)	Power (Watts)	Propagation Rate	
			(cm/min)	(in./min)
2.7	0.9	2.4	<1	<0.4
3.8	1.9	7.2	1	0.4
2.9	2.7	7.8	1	0.5
2.8	3.6	10.1	2	0.6
2.4	4.6	11.0	2.5	1.0
2.1	5.7	12.0	2.8	1.1
1.9	6.6	12.5	3.3	1.3
2.0	7.7	15.4	4.1	1.6
2.0	8.7	17.4	6.4	2.5
3.1	9.9	30.7	9.1	3.6
4.0	10.0	40.0	31	12
15.0	3.3	49.5	76	30
18.0	4.5	81.0	76	30
28.0	3.4	95.2	76	30
30.0	4.0	120	76	30
35.0	4.0	140	76	30

20 AWG

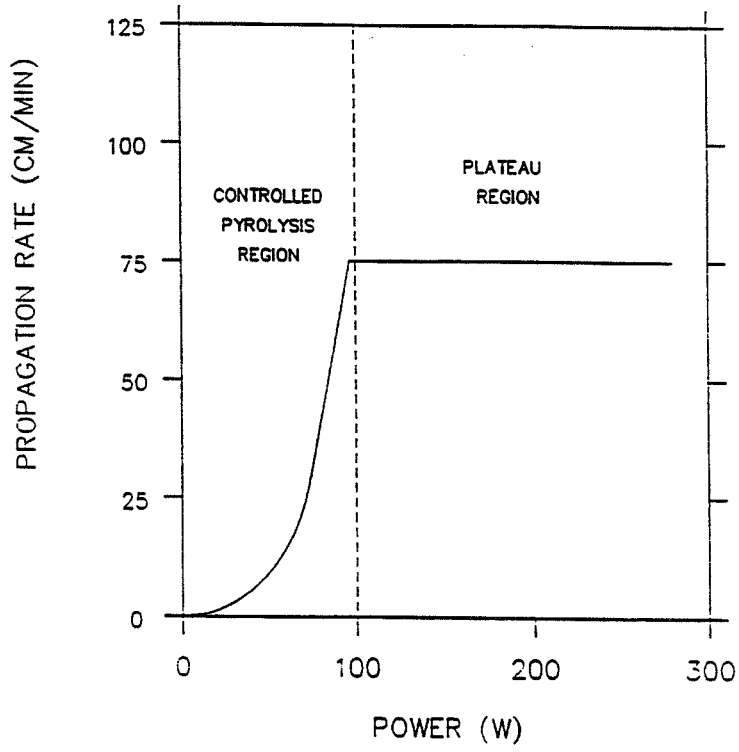

26 AWG

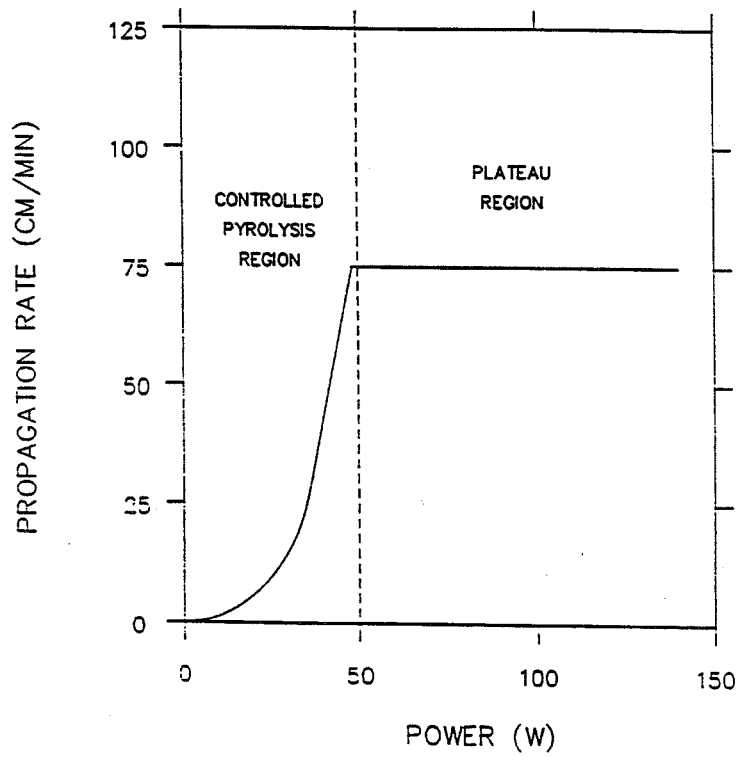

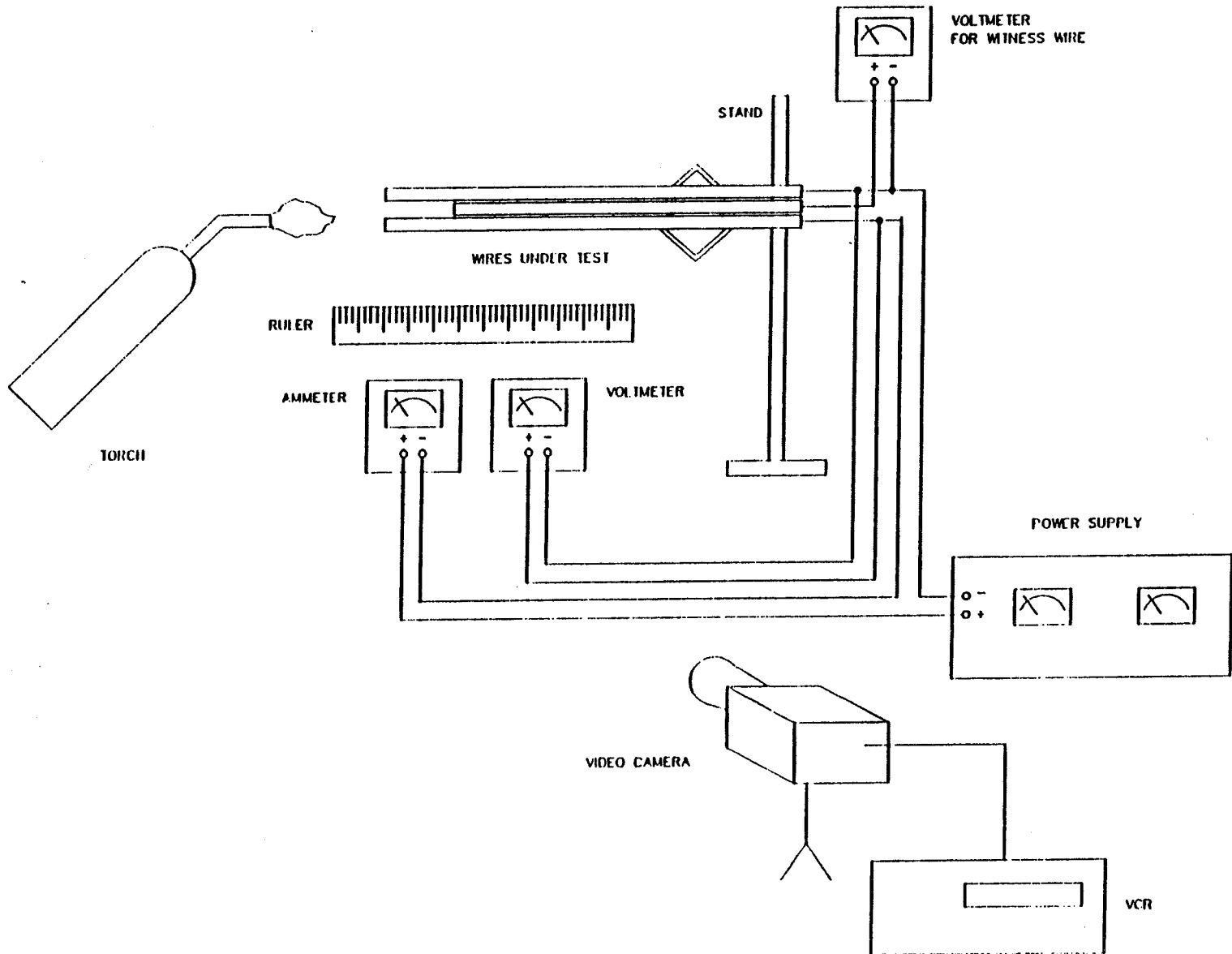

Adjacent Wire Pyrolysis Test Procedures

Five sets of three 36-cm (14-in.) long, polyimide-insulated wires were constructed from both 20 and 26 AWG wire. Each set was held together in a parallel configuration with common sewing thread to simulate a parallel wire bundle configuration. Each wire set was positioned horizontally in a metal clamp attached to a metal stand. To study the effects of pyrolysis on an adjacent wire, the middle wire was shortened by 5-cm (2 in.) The voltmeter was placed in parallel with the middle wire and the negative side of the power supply to measure voltage across the wire insulation during pyrolysis.

- The two outside wires were energized with 28 V and 10 A (to ensure pyrolysis), while the middle (adjacent) wire was left as an open circuit.
- The video recording system was activated and the propane torch was used to pyrolyze the ends of the 36-cm (14-in.) wires.

Spectrometer Test Procedures

Twenty sets of both 20 and 26 AWG twisted pair, open circuit, polyimide-insulated wires (36-cm [14-in.] long) were constructed. Each pair of previously pyrolyzed wire was positioned horizontally in a metal clamp attached to a metal stand, and then placed into the spectrometer's field of view. Power supply and meter connections were made at the ends of the wires held in place by the metal clamp. A ruler was placed under the wires (to facilitate the measurement of the propagating-pyrolysis rate) and the video system was activated.

- The voltage limit was set to 5 V for 20 AWG wires (15 V for 26 AWG wires) and increased in 5 volt increments (up to 28 V for 20 AWG wires and to 40 V for 26 AWG wires).
- At each voltage increment, the current was increased slowly until rapidly propagating pyrolysis occurred or the maximum power supply current level was reached. When characteristic arc emissions were detected, the minimum voltage threshold to support arc emissions was recorded.

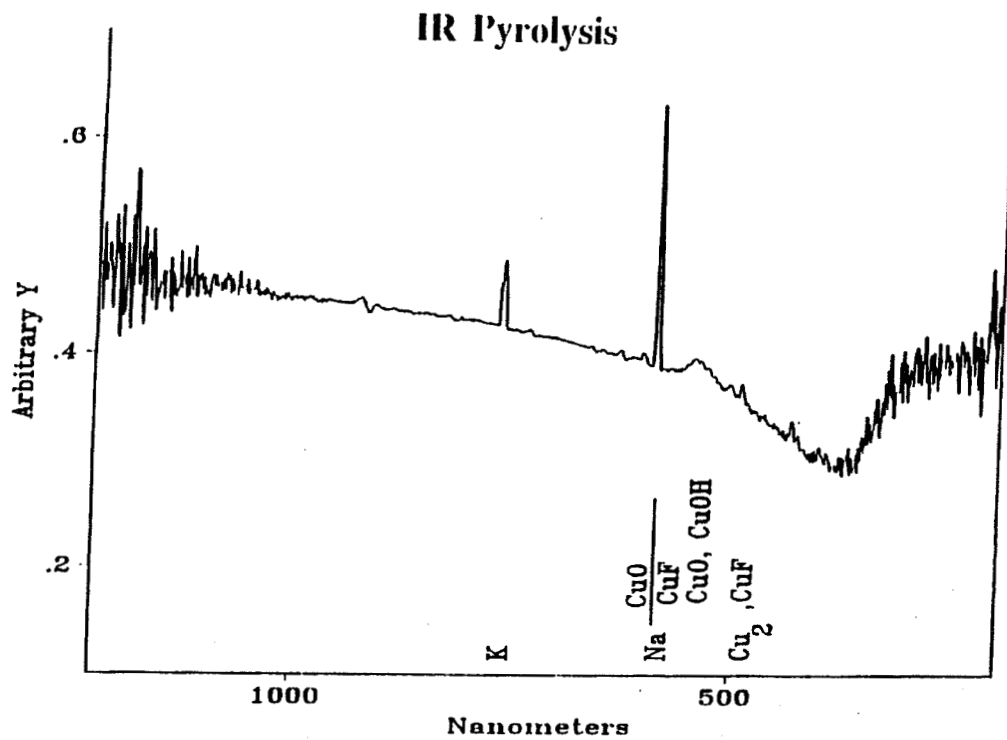
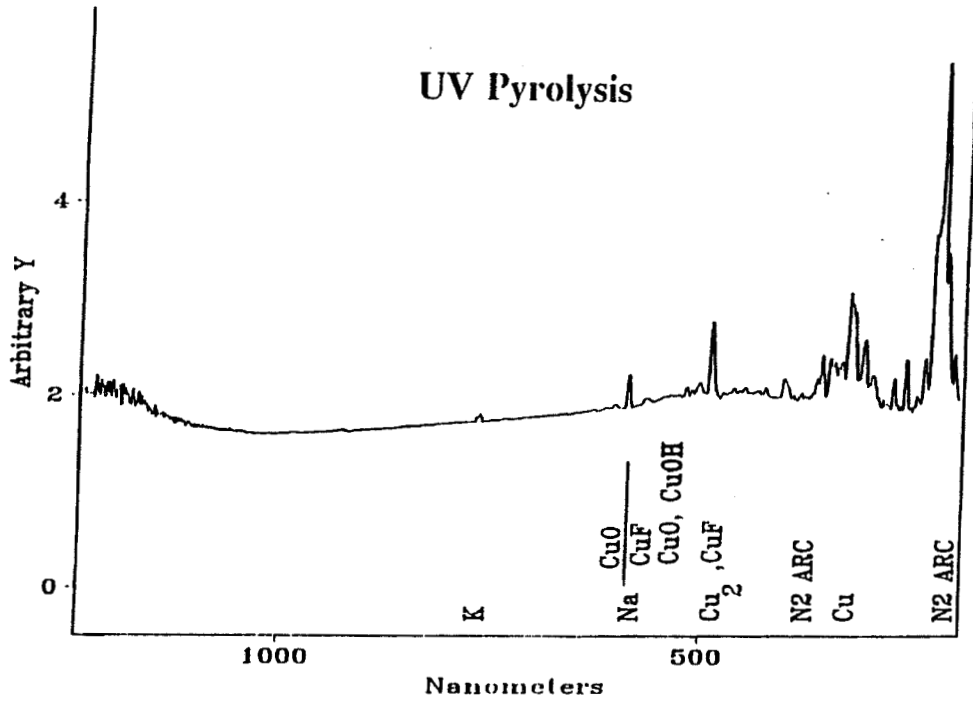

Electrical Power In = Heat Loss of Decomposition Zone

$$P_{in} = Q_{Loss} \quad (1)$$

Assuming that convection heat losses are negligible, and that steady-state conditions exist, then:

$$P_{in} = \epsilon\sigma(T^4 - 300^4)\alpha_{eff} + \sum_{j=1}^n \left[\frac{k_j A_{eff}^j (T - 300)}{l_j} \right] \quad (2)$$

where the second term is the sum of conductive heat losses from the decomposition zone, and where

- ϵ = emissivity ≈ 1.0
- σ = $5.67 \times 10^{-12} \frac{w}{cm^2 K^4}$
- T = steady-state temperature of decomposition zone
- α_{eff} = effective area of decomposition zone (0.035 cm^2 for 20 AWG wire)
- n = number of materials
- k_j = coefficient of thermal conductivity
- A_{eff}^j = effective area of conductor (heat loss) material
- l_j = length of heat flow path for conductor (heat loss) material

Solving the fourth order polynomial for its real root yields the temperature as a function of electrical power (Figure 15).

Table 1
Typical Constants for Steady-State Equation for Heat Transfer of
20 AWG Wire Pairs

Material	k_j $\left[\frac{w}{cm K} \right]$	A_{eff}^j (cm^2)	l_j (cm)
Air	2.5×10^{-4}	0.05	0.1
Kapton (20 Ga)	3.0×10^{-3}	0.01	1.0
Copper (19-32 Ga)	4.0	0.005	1.0

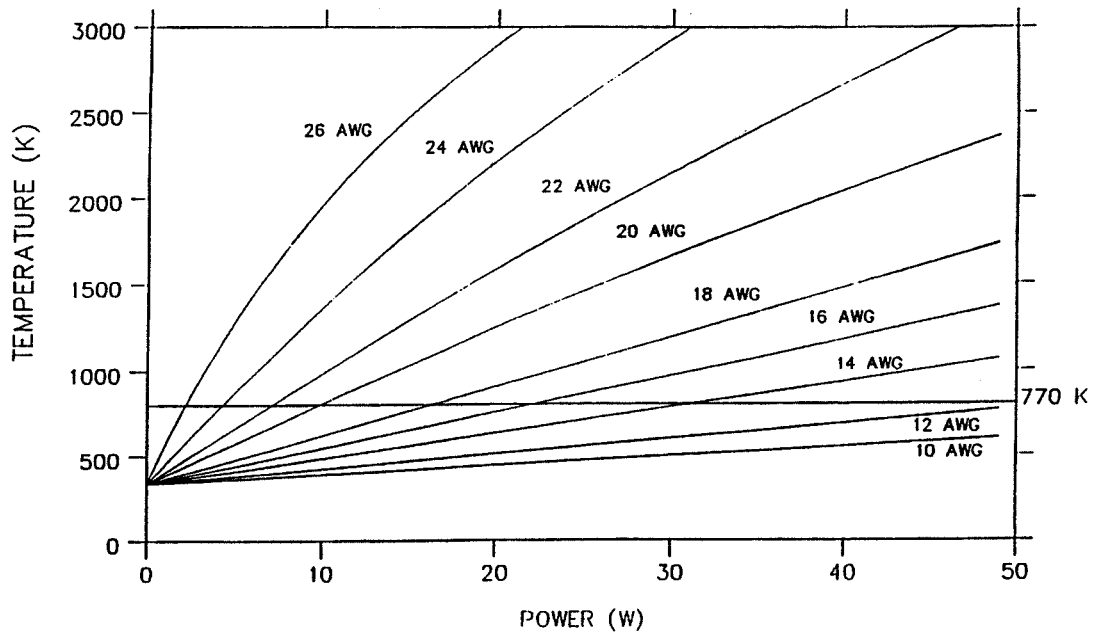

Conclusions

- Thermogravimetric Decomposition Threshold
Temperature of Kapton Insulation Material Measured in Air 773 K
 - Resistance of Pyrolyzed Kapton Insulation < 150 ohms.
Damage Occurs Within 5 Seconds of Arc-Induced Exposure.
 - Pyrolytic Thresholds and Propagation Rates Measured:
 - Electrical Power Pyrolytic Thresholds
 - 20 AWG Kapton Wire = 10 WATTS
 - 26 AWG Kapton Wire = 2.5 WATTS
 - Pyrolytic Propagation Rates
 - Nonlinear Rate from 10-100 WATTS for 20 AWG
Plateau Rate: 76 cm/min 100-300 WATTS
 - Nonlinear Rate from 2.5-50 WATTS for 26 AWG
Plateau Rate: 76 cm/min 50-150 WATTS
- Crossover Region Between Nonlinear and Plateau Indicated Electrically as a Switching Region from Resistive Heating Damage to Arc Damage

Conclusions

- Adjacent Wire Insulation Damage by a Pyrolysis Zone
 - 2 Seconds with 280 WATTS (28 VDC @ 10 A) for 20 AWG
- Pyrolytic Spectral Characteristics Measured in Air
 - Resistive Heat Damage -- Planck IR Radiation Emissions
 - < 16 VDC @ 20 AWG
 - < 28 VDC @ 26 AWG
 - Arc Damage -- Ultraviolet Emissions Peaks (190-350 NM)
 - > 16 VDC @ 20 AWG
 - > 28 VDC @ 26 AWG
 - Arc versus Resistive Heating Damage Mechanisms Are Not Completely Understood, But Thresholds Are Considered to be Related to the Minimum Voltage (Potential) Required to Ionize Air for a Specific Wire Spacing
- Theoretical Model
 - Predicts pyrolytic temperature versus electrical power
 - Benchmarked with 20 AWG and predicted 26 AWG
 - Model demonstrates the significance of the conductors to remove heat from the pyrolytic zone

30140

P. 12

109633

352964

PROBLEMS WITH AGING WIRING IN NAVAL AIRCRAFT

F. J. CAMPBELL

NAVAL RESEARCH LABORATORY

WASHINGTON, DC

ABSTRACT

The Navy is experiencing a severe aircraft electrical wiring maintenance problem as a result of the extensive use of an aromatic polyimide insulation that is deteriorating at a rate that was unexpected when this wire was initially selected. This problem has significantly affected readiness, reliability, and safety and has greatly increased the cost of ownership of Naval aircraft.

Failures in wire harnesses have exhibited arcing and burning that will propagate drastically, to the interruption of many electrical circuits from a fault initiated by the failure of deteriorating wires. There is an urgent need for a capability to schedule aircraft rewiring in an orderly manner with a logically derived determination of which aircraft have aged to the point of absolute necessity.

Excessive maintenance was demonstrated to result from the accelerated aging due to the parameters of moisture, temperature, and strain that exist in the Naval Aircraft environment. Laboratory studies have demonstrated that MIL-W-81381 wire insulation when aged at high humidities followed the classical Arrhenius thermal aging relationship. In an extension of the project a multifactor formula was developed that is now capable of predicting life under varying conditions of these service parameters. An automated test system has also been developed to analyze the degree of deterioration that has occurred in wires taken from an aircraft in order to obtain an assessment of remaining life. Since it is both physically and financially impossible to replace the wiring in all the Navy's aircraft at once, this system will permit expedient scheduling so that those aircraft that are most probable to have wiring failure problems can be overhauled first.

AIRCRAFT WIRE SERVICE LIFE

PROBLEM

- **KAPTON WIRE INSULATION DETERIORATING PREMATURELY.**
 - **ACCELERATED BY MOISTURE, MECHANICAL AND ELECTRICAL STRESSES.**
 - **SERVICE LIFE SHORTER THAN DESIGN LIFE.**
- **CONSEQUENCES OF INITIAL PREMATURE FAILURES LEAD TO SHORT-CIRCUIT ARCING.**
 - **COMPLETE WIRING BUNDLE SEVERED WITH A SINGLE WIRE FAULT.**
- **NAVY NEEDS TO PLAN ITS MAINTENANCE BUDGET.**

OBJECTIVE

DEVELOP A METHODOLOGY FOR DETERMINING AN OVERHAUL SCHEDULE FOR KAPTON WIRED NAVAL AIRCRAFT.

MIL-W-81381/11
KAPTON

WIRE, ELECTRIC, FLUROCARBON/POLYIMIDE INSULATED,
MEDIUM WEIGHT, SILVER COATED COPPER CONDUCTOR, 600 VOLT,
NOMINAL 8.4 MIL WALL, 200°C

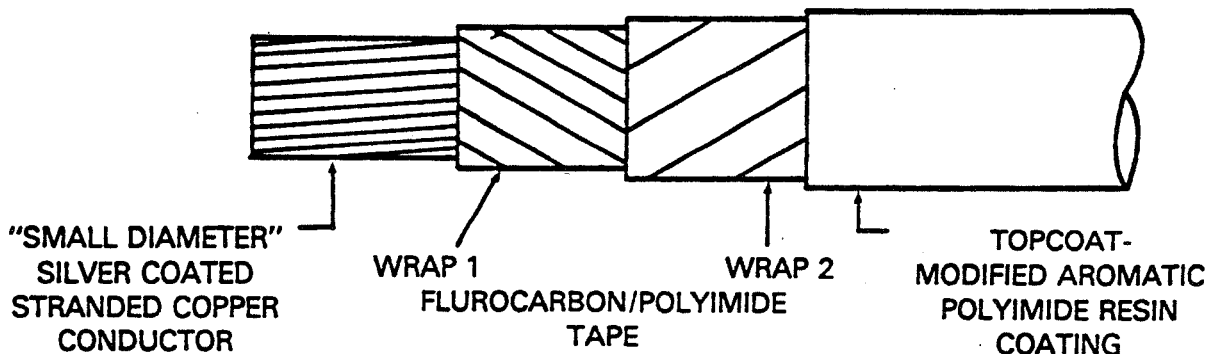

NAVAL AIRCRAFT CONCERNS

- DRY WIRE FLASHOVER AND BURNING
- WET WIRE TRACKING AND FLASHOVER

MAINTENANCE AND DESIGN
FOR FAULT PREVENTION
INITIAL WIRE SELECTION

- SYSTEMS AND FAILURE MECHANISMS

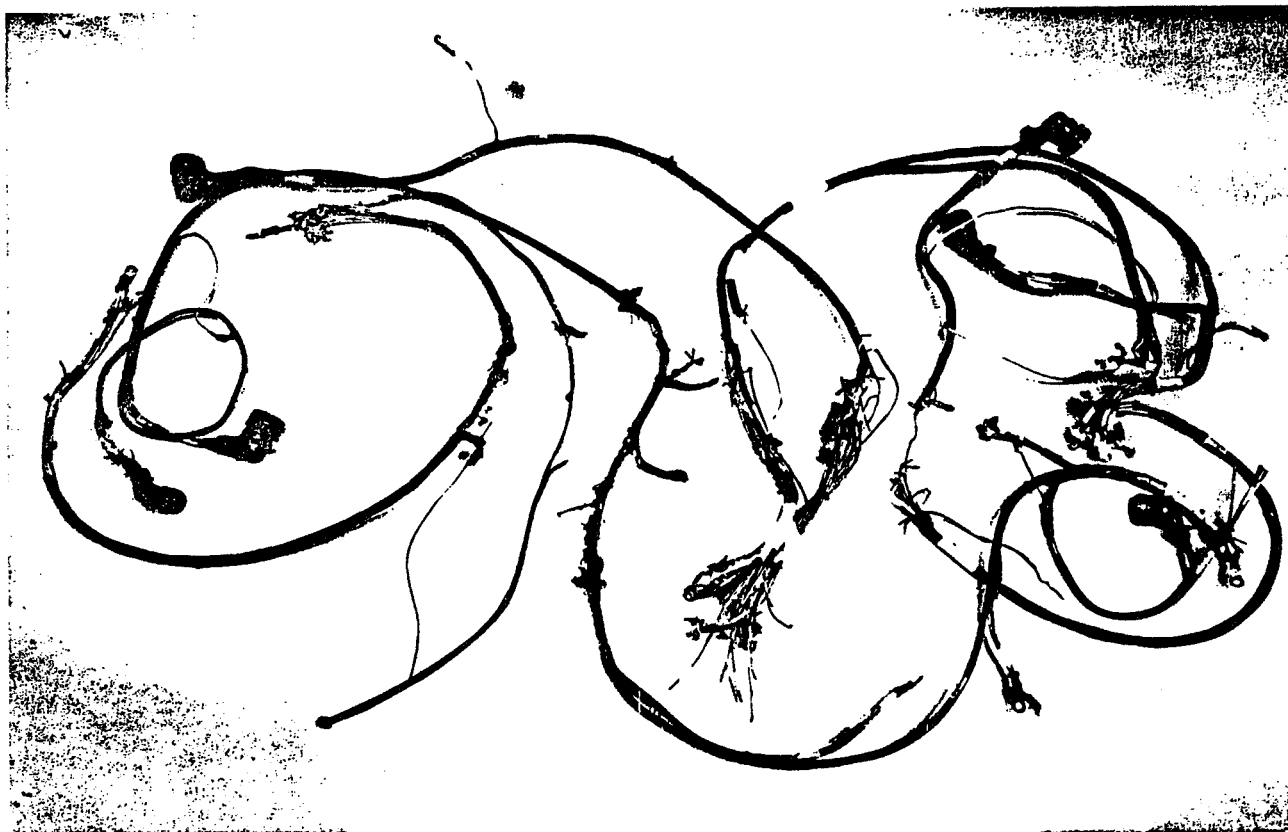

F/A-18 FORWARD FUSELAGE CABLE ASSEMBLY
INFLIGHT WIRE HARNESS CHAFING ARCING/FIRE
SEVERED LEFT AND RIGHT GENERATOR CIRCUITS

STRIKE FIGHTER SQUADRON 136
MAYPORT NAVAL AIR STATION, FLORIDA
8 APRIL 1987

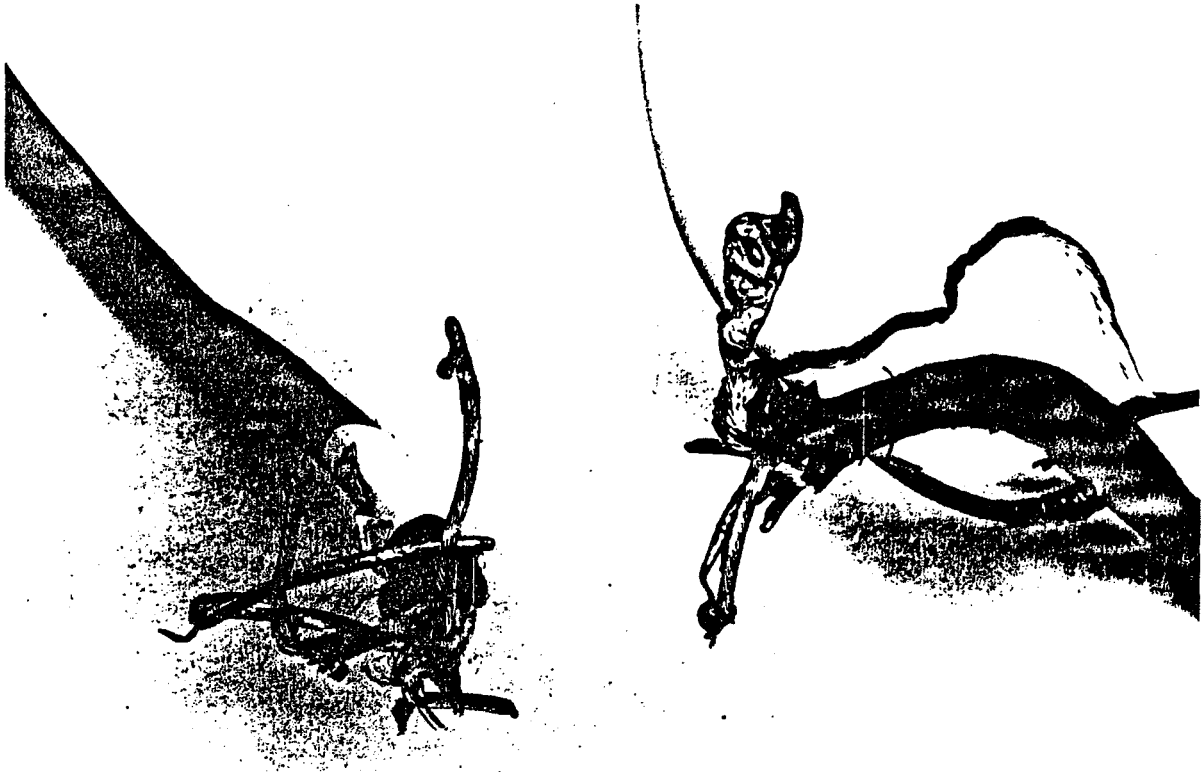

AIRCRAFT WIRE SERVICE LIFE

PAYOFF

- o NAVY HAS APPROXIMATELY 4,000 A/C WITH KAPTON WIRING
- o NAVY NEEDS TO PLAN ITS WIRING REPLACEMENT BUDGET
\$1M TO \$4M FOR EACH A/C
- o SPECIFIC REPLACEMENT OF PROBLEM WIRING HARNESSSES AS ALTERNATIVE
- o NAVY IS SCHEDULING OVERHAULS
 - F-14 A TO D CONVERSION
 - S-3 A TO B
 - A-6 E TO F
 - EA-6B AVIONICS UPDATE

PLANNED F-14 A TO D CONVERSION SCHEDULE - 450 AIRCRAFT

<u>YEAR</u>	<u>NUMBER OF A/C</u>
1990	6
1991	12
1992-2010	24 PER YEAR

APPROACH

- DEVELOP ARRHENIUS PLOTS OF RELATIVE HUMIDITY SUPERIMPOSED ON TEMPERATURE-LIFE CURVES
- DEVELOP DATA BASE OF STRESS INFLUENCES ON THE HYDROLYSIS DEGRADATION RATE
 - MECHANICAL STRESS
- DEVELOP FORMULAS FOR EXPRESSING EFFECTS OF INTERACTIVE FACTORS
- DEVELOP MODEL FOR INTEGRATING CUMULATIVE DEGRADATION AS A FUNCTION OF TIME AT VARIOUS ENVIRONMENTAL AND STRESS FACTORS FROM A TYPICAL SERVICE DEPLOYMENT HISTORY.

CHEMICAL MECHANISM OF KAPTON HYDROLYSIS

Polymer Chain Repeating Unit

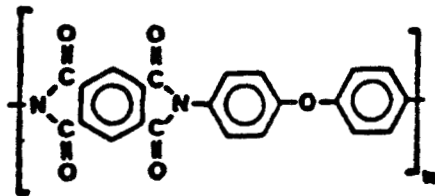

Chain Splitting Reaction

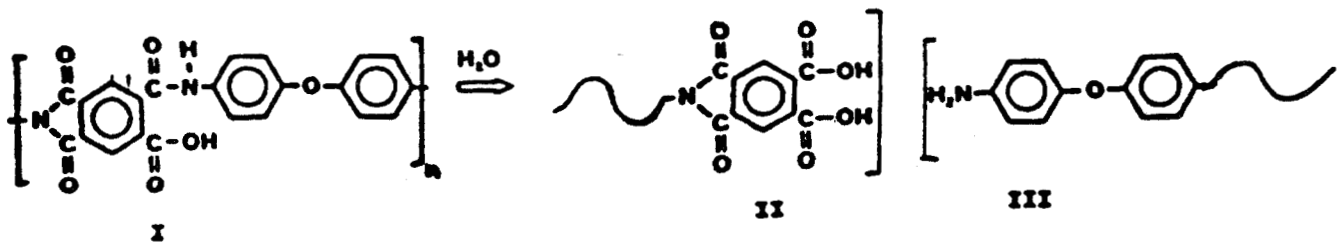

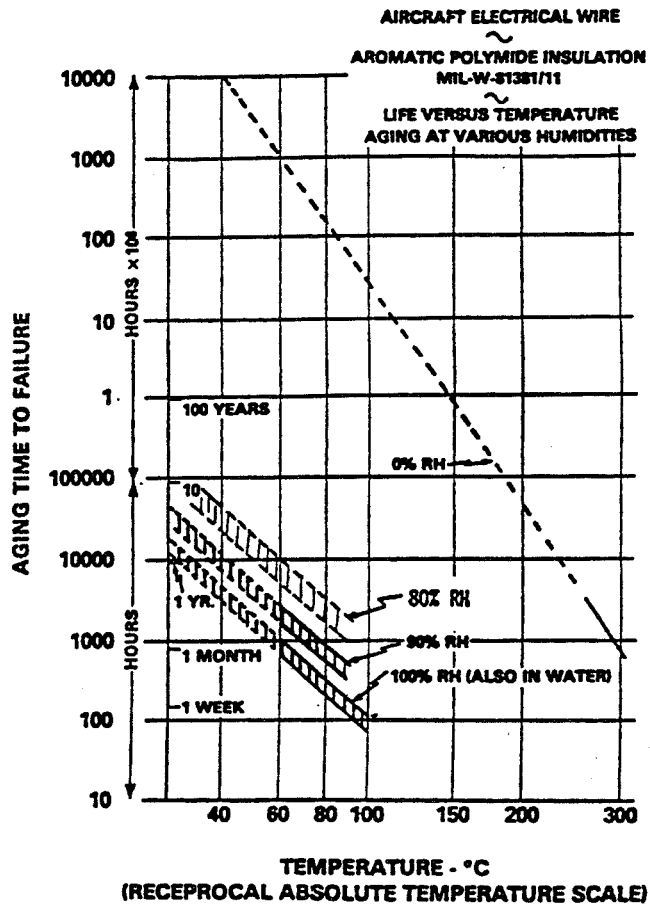
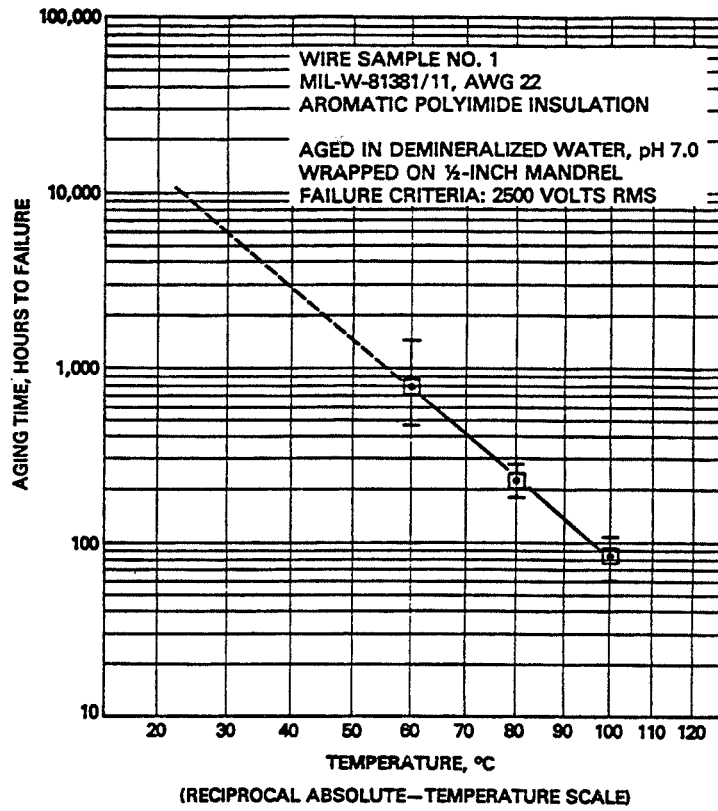

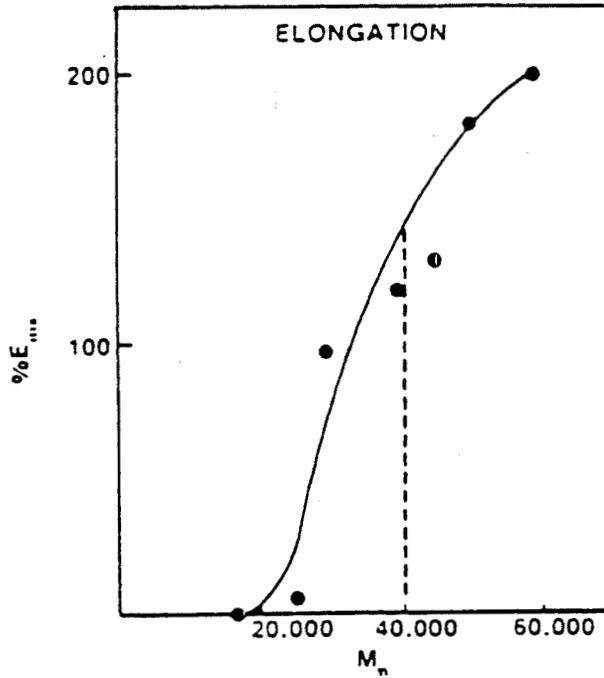

$\% E_{mx}$ is the percent elongation (mechanical strain) at which the polyimide insulation fractures.

M_n is the number average molecular weight of the polyimide molecules in the insulation.

- Relationship between the elongation at break and the molecular weight of the polyimide. (Reference: M.L. Wallach, Journal of Polymer Science, A-2, 6, 953 (1968)).

WIRE INSULATION DETERIORATION MECHANISM

IS A MULTIFACTOR STRESS EFFECT

DETERIORATION RATE AS A FUNCTION OF BEND DIAMETER

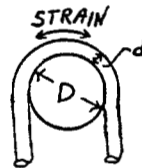

$$\text{STRAIN (\%)} = \frac{100}{1 + D/d}$$

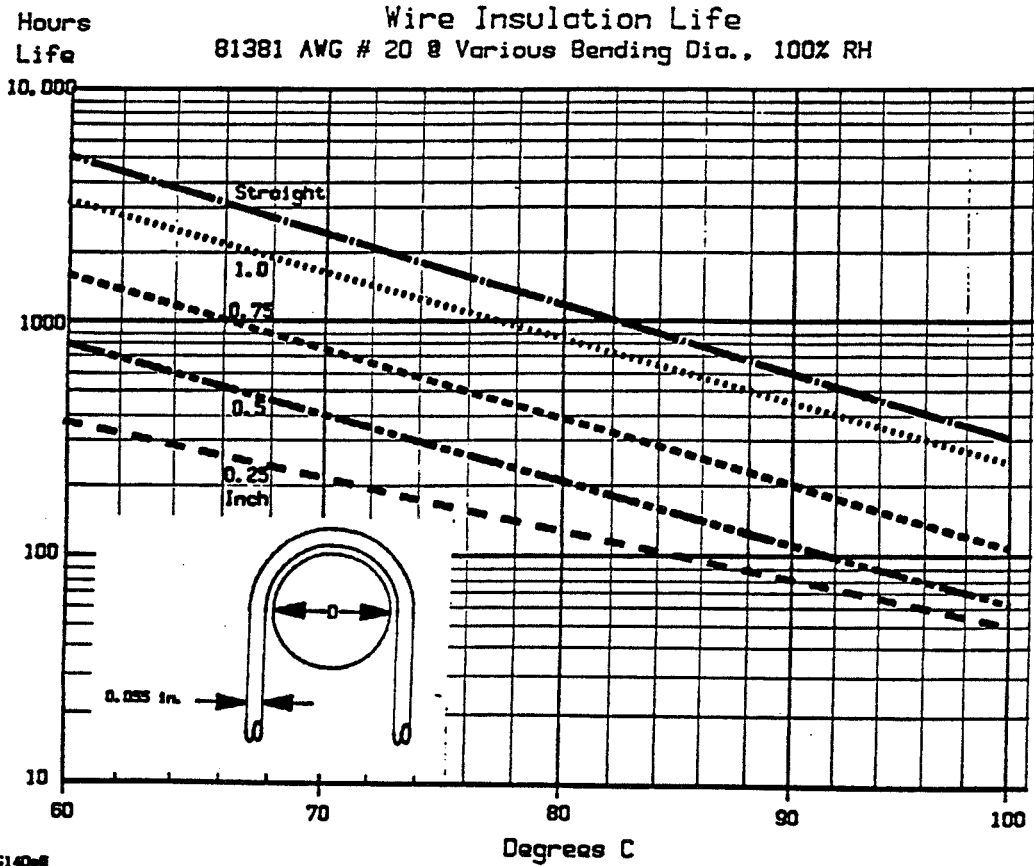

File: A-6140e8

MULTI-FACTOR STRESS FORMULA

$$\text{LOG (Life)} = \text{INTERCEPT (R.H.)} - \text{SLOPE (D/d)/(T}^\circ\text{C} + 273)$$

GIVEN VARIABLES: TIME OF EXPOSURE TO RELATIVE HUMIDITY AND TEMPERATURE
BEND DIAMETER OF THE INSTALLED WIRE
WIRE DIAMETER

D/d	4.5	9.1	10.6	11.9	13.6	18.2	36.4	100	inf
-Slope(D/d)	3160	3223	3241	3256	3273	3330	3521	3821	4500

Relative Humidity	0.0 %	70 %	80 %	90 %	100 %
Intercept(R.H.)	0.0	-5.0	-5.9	-6.2	-6.8

A COMPUTER MODEL HAS BEEN DEVELOPED TO INTEGRATE SERVICE AGING PARAMETERS INTO THE FORMULA TO PREDICT LIFE OF THE WIRES, USING A PROGRAM WE HAVE WRITTEN INTO THE SOFTWARE PACKAGE, TKISOLVER.

AIRCRAFT WIRE SERVICE LIFE

OBJECTIVES ACCOMPLISHED

- * DEVELOPED A COMPUTER MODEL FOR INTEGRATING SERVICE CONDITIONS WITH AGING RATES TO CALCULATE REMAINING WIRE LIFE
 - IN ORDER TO SCHEDULE WIRING OVERHAUL PRIORITIES.
- * DEVELOPED A SYSTEM TO DETERMINE THE DEGREE OF WIRE INSULATION DETERIORATION BY LABORATORY ANALSES OF PERIODIC SAMPLES
 - IN ORDER TO TRACK REMAINING LIFE
 - SUPPORT CALCULATIONS MADE BY THE COMPUTER MODEL.
- * DEVELOPED A MULTI-FACTOR STRESS THEORY AND PROCESS FOR DETERMINING SERVICE LIFE OF ORGANIC MATERIALS BY ACCELERATED LABORATORY AGING EXPERIMENTS.

W I D A S

Wire Insulation Deterioration

Analysis System



W I D A S

PURPOSE

- o Determine amount of Kapton wire insulation deterioration BEFORE wire failure and/or destructive arcing occurs.

SYSTEM PROCEDURE

- o Select Aircraft to be Tested
- o Identify Locations
- o Remove Wire Samples
- o Test Samples in LAWIDA
- o Analyze Results
- o Report to Customer
- o Establish History Data Base

ORGANIZATIONS THAT USE KAPTON

U.S. NAVY

U.S. AIR FORCE

U.S. ARMY

N.A.S.A. SPACE SHUTTLE

NATO MILITARY AIRCRAFT

DOMESTIC AND FOREIGN COMMERCIAL AIRLINES

NUCLEAR POWER PLANTS

ACTION

- 0 AS A DIRECT RESULT OF THIS PROGRAM THE U.S. NAVY AND THE U.S. ARMY HAVE ISSUED DIRECTIVES ABOLISHING THE FURTHER USE OF KAPTON WIRE.

ADDITIONAL WIRING PROGRAM ASSIGNMENTS

- 0 AGING ANALYSIS OF KAPTON WIRING IN AGING AIRCRAFT.
- 0 STUDY ALTERNATE INSULATION SYSTEMS AND KAPTON HYBRIDS FOR MOST PROBABLE FAILURE MODES.
- 0 DEVELOP STANDARD TEST METHODS FOR DETERMINING SUSCEPTIBILITY TO HARNESS DESTRUCTION FROM PROJECTILES, CHAFING AND WET-TRACKING.
- 0 STUDY EFFECTS OF 270 VOLT DC ON WIRE LIFE, ARCING AND TRACKING RESISTANCE.
- 0 STUDY NEW TECHNOLOGY CIRCUIT PROTECTION METHODS.
- 0 DEVELOP METHODS TO DETECT INCIPIENT FAULTS.
- 0 STUDY LIGHTNING STRIKE EFFECTS ON COMPOSITE CONNECTORS.
- 0 MAINTAIN LIAISON WITH MILITARY AND INDUSTRIES OF U.S. AND ALLIED NATIONS ABOUT WIRING FAILURE CONCERNS.

30141
p. 8
109634
352965
88

**Kapton Pyrolysis on Space Station Freedom's
Solar Array Flexible Current Carrier**

Thomas J. Stueber
Sverdrup Technology, Inc.
National Aeronautic and Space Administration (NASA)
Lewis Research Center (LeRC) group
Cleveland, Ohio

Objectives:

- * Investigate possible events that could cause the kapton to pyrolyze.
- * Investigate the degree of damage when the kapton pyrolyzes.

.07" spacing between copper conductors

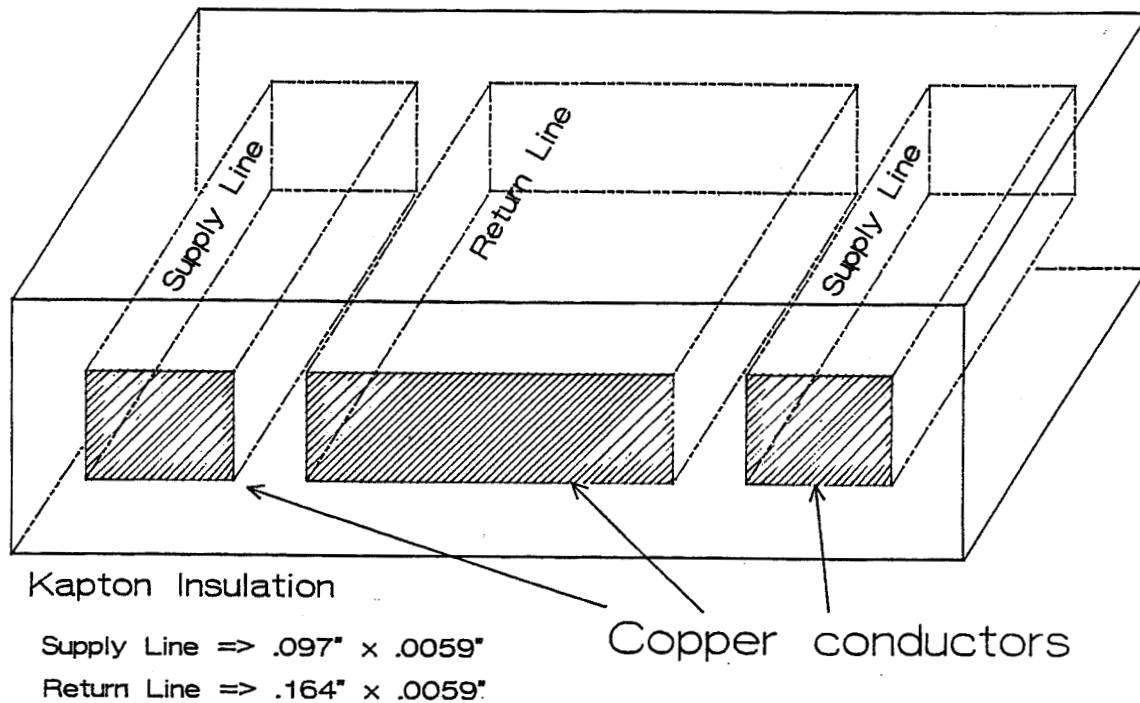

One Channel Sample FCC

Simulation of possible causes of FCC Kapton Pyrolysis in LEO:

- * **Leo space plasma interaction.**
- * **micro-meteoroid or debree impact.**
 - * Local plasma created by energetic debree or micro_meteoroid impacts. (capacitive).
 - * Local plasma generation when conductor breaks (inductive).
- * **Momentary current carrier shorts.**
 - * Micro-meteoroid and debree impacts
 - * Extension and retraction of atomic oxygen eroded Kapton.

Possible Causes:

LEO SPACE PLASMA

INTERACTION.

TEST POSITION IN THE LeRC A/O FACILITY OXYGEN PLASMA ENVIRONMENT

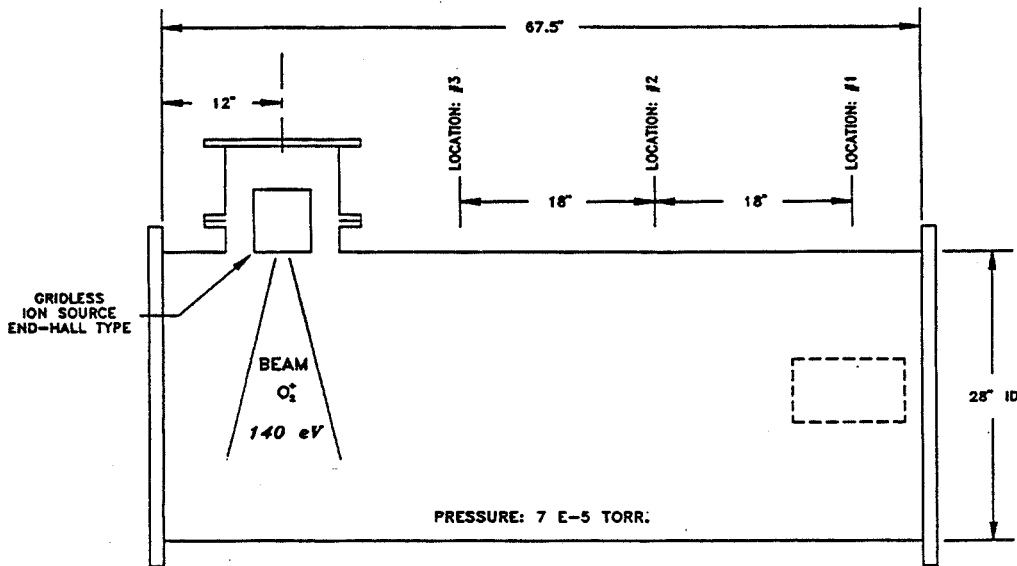

ENCLOSED CAGE AT FLOATING POTENTIAL.
FCC SAMPLE LOCATED INSIDE OF CAGE
AND BIASED (-200 V) WITH RESPECT TO
THE CAGE POTENTIAL.

PYROLIZATION TEST PLASMA DATA

DATE	Run No.	KT_e/e (eV)	n_i (#/cm ³)	j_e (mA/cm ²)	j_i (mA/cm ²)	Plasma Potential (V)	Floating Potential (V)
1990							
12/5	1	3.7	4.3 E7	.22	2.3 E-3	15	-6.5
12/6	1	4.8	4.1 E7	.24	2.5 E-3	23	-9.0
12/6	2	3.5	6.8 E7	.35	3.5 E-3	19.5	-6.0

Oxygen Plasma Environment (O₂⁺)

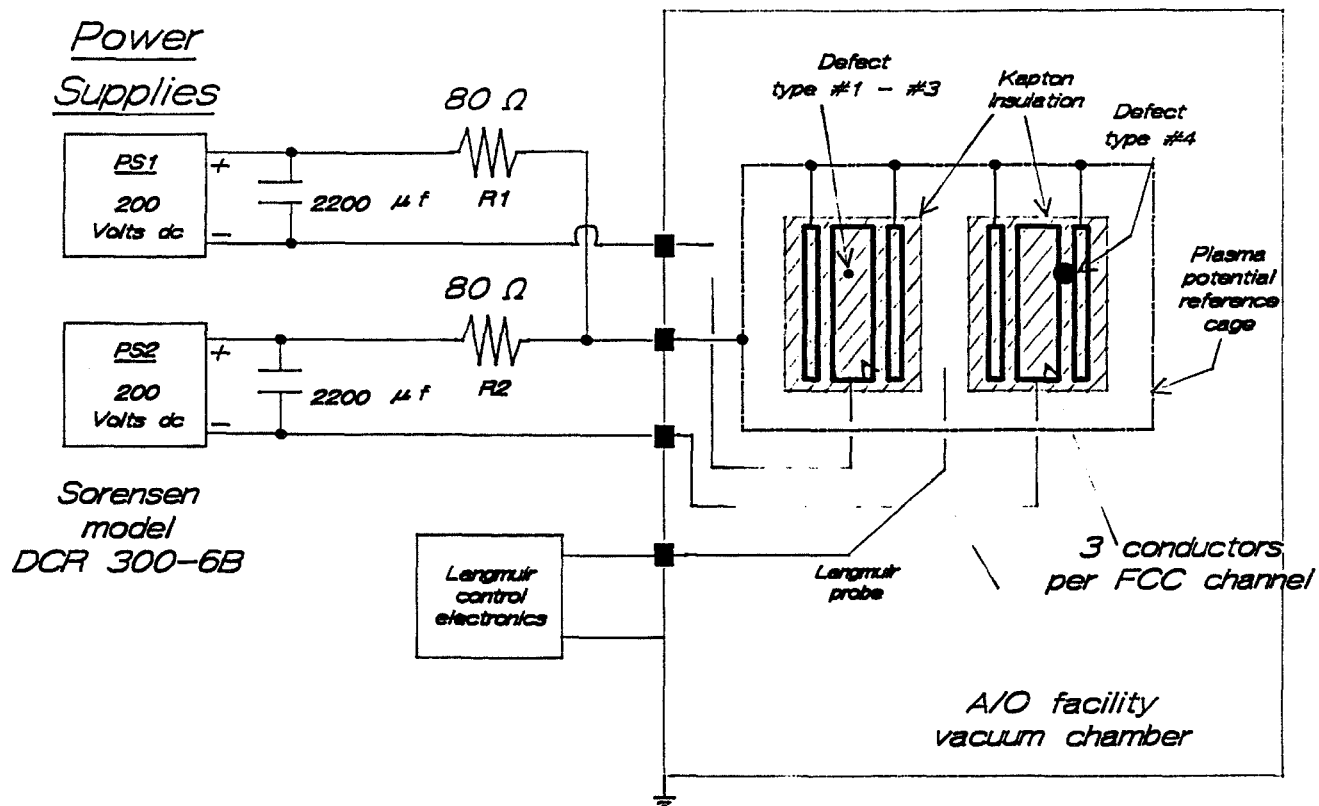

Results:

- * **No destructive arcing occurred on FCC.**
- * **No visual damage to FCC as a result of test.**

Possible Cause:

**MICRO-METEOROID or
DEBREE IMPACTS.**

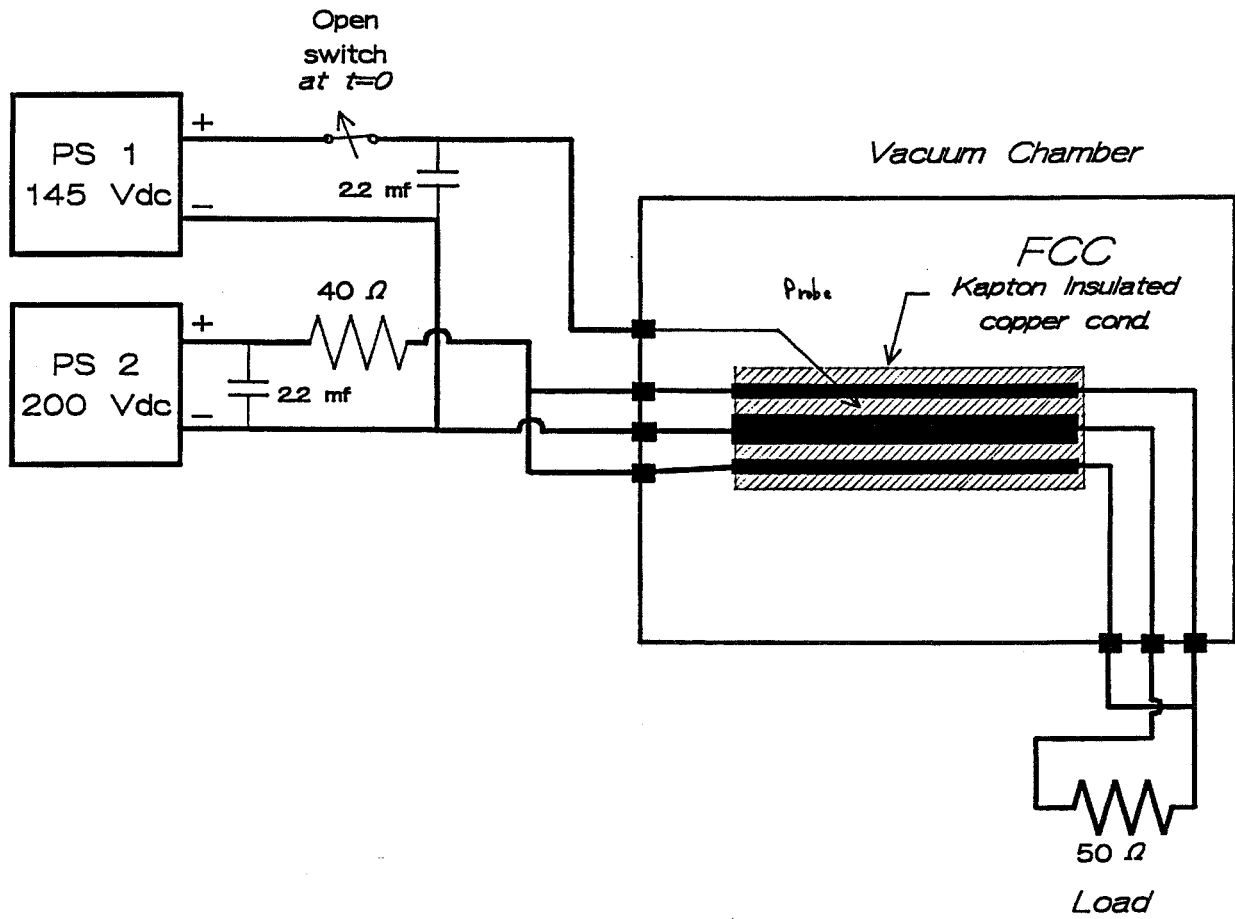

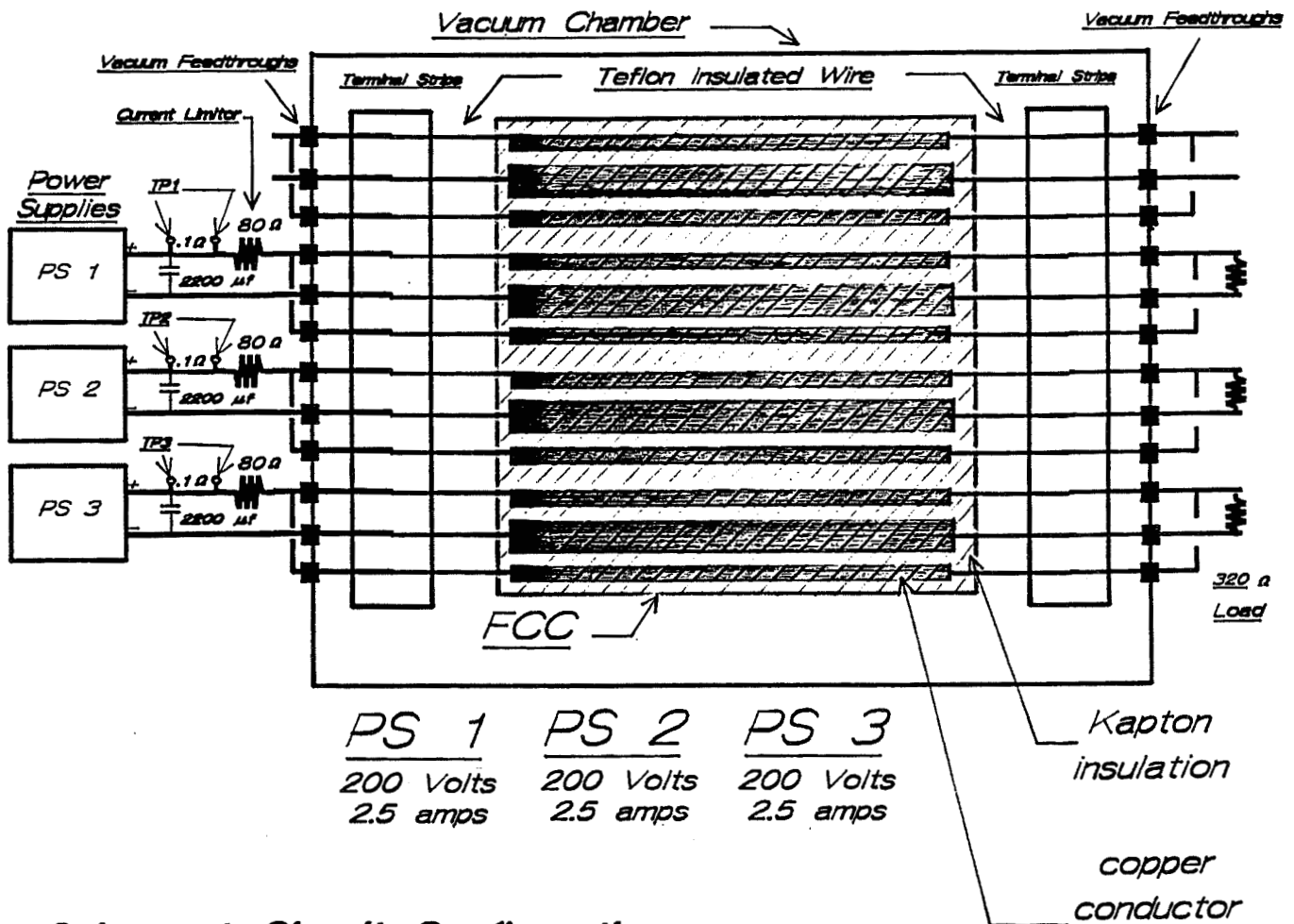
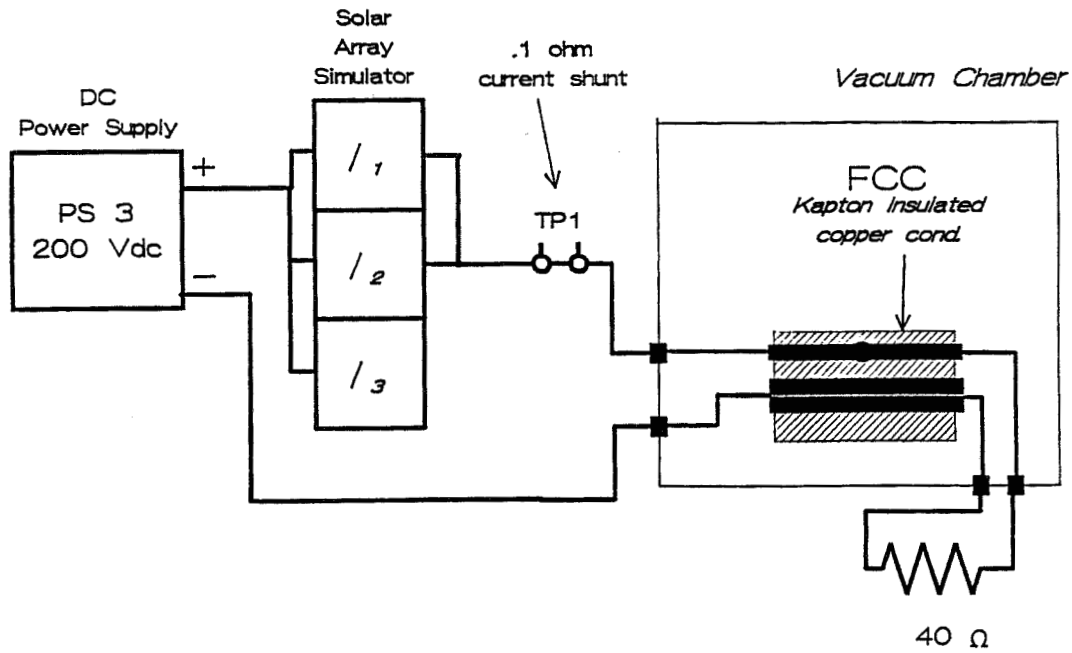

Quiescent Circuit Configuration.

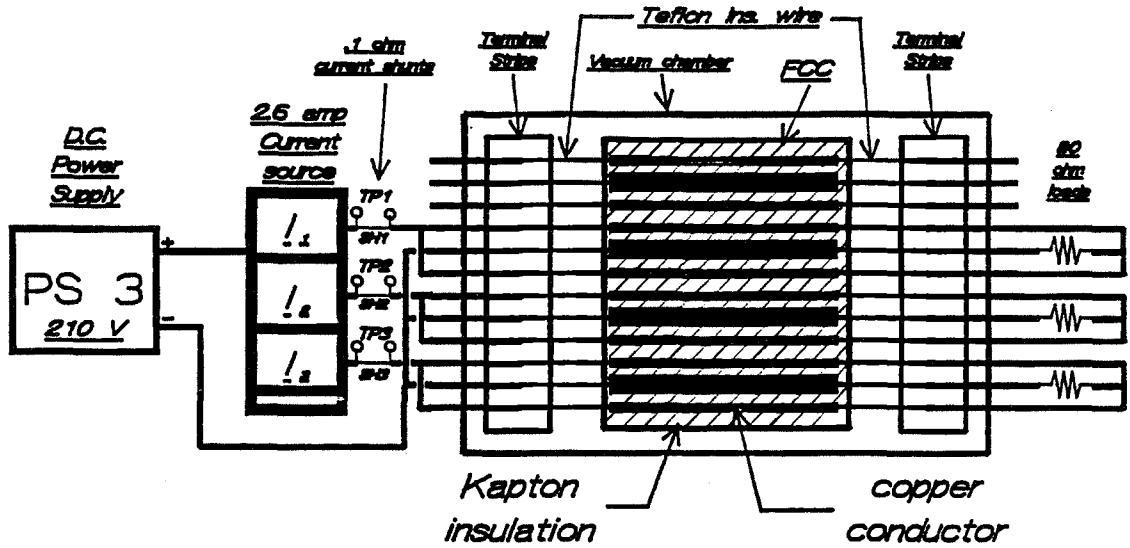

Solar Array Simulator Circuit configuration.

MOMENTARY CURRENT CARRIER SHORTS:

- * INVESTIGATION OF EVENTS CAUSING PYROLYSIS.**
- * DAMAGE ASSESSMENT**

Test #7

Objective:

Identify, the threshold power to initiate the Kapton pyrolysis event.

Circuit:

Quiescent circuit configuration.

Procedure:

Only one channel energized.

Voltage incremented from 0 to 200 Vdc.

Create a short circuit at each voltage increment.

Results:

Pyrolysis and arc tracking initiated when the voltage was set at 145 volts dc.

Only 90 volts was necessary to restart arc tracking event.

History of sparks at the defect site seemed to be contributing factors.

Test #8

Objective:

Identify Power requirements for Kapton pyrolysis.

Circuit:

Solar Array circuit configuration.

Procedure:

Only one channel energized.

Current incremented from 0 to 2.5 amps.

Create an arc at the defect site after each increment in current.

Results:

Pyrolysis, and arc tracking experienced at 2 amps.

Test #9

Objective:

Identify power necessary to promote Kapton Arc Propagation.

Circuit:

Quiescent Circuit Configuration.

Procedure:

All three channels will be energized.

Voltage incremented from 145 Vdc.

Create an arc after every increment in voltage.

Results:

Propagation occurred at 192 volts.

Arc did not cross over fat return lines.

Results:

- * Kapton pyrolysis, which leads to the arc tracking and propagation even can occur on the SSF FCC.**
- * With the current power specs of the photovoltaic array (160 V, 5 amps) a spark can ignite the Kapton pyrolysis catastrophe.**
- * With improved thermal design, the arc tracking event may be inhibited or short lived.**

N95-16050

5017
P-14
109635
352906

COMBUSTION AND FIRES IN LOW GRAVITY

ROBERT FRIEDMAN
NASA LEWIS RESEARCH CENTER
SPACE EXPERIMENTS DIVISION
MAIL STOP 500-217
CLEVELAND OH 44135

FIRE SAFETY IN NASA HUMAN-CREW SPACECRAFT

- FIRE SAFETY ALWAYS RECEIVES PRIORITY ATTENTION IN NASA MISSION DESIGNS AND OPERATIONS, WITH EMPHASIS ON FIRE PREVENTION AND MATERIAL ACCEPTANCE STANDARDS

- RECENTLY, INTEREST IN SPACECRAFT FIRE-SAFETY RESEARCH AND DEVELOPMENT HAS INCREASED BECAUSE
 - IMPROVED UNDERSTANDING OF THE SIGNIFICANT DIFFERENCES BETWEEN LOW-GRAVITY AND NORMAL-GRAVITY COMBUSTION SUGGESTS THAT PRESENT FIRE-SAFETY TECHNIQUES MAY BE INADEQUATE OR, AT BEST, NON-OPTIMAL

 - THE COMPLEX AND PERMANENT ORBITAL OPERATIONS IN *FREEDOM* DEMAND A HIGHER LEVEL OF SAFETY STANDARDS AND PRACTICES

SPACECRAFT FIRE RISK STRATEGIES

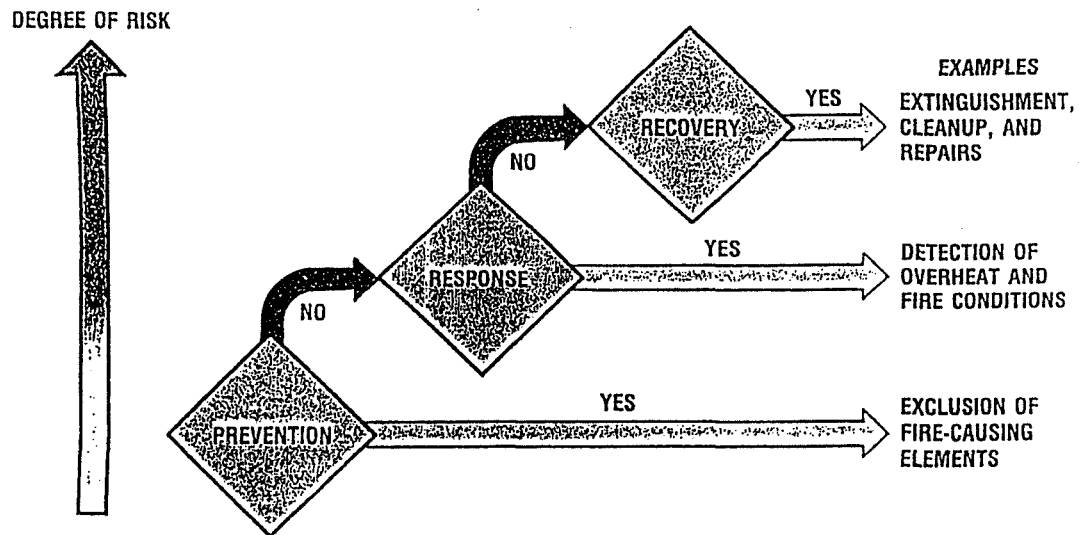

SPACECRAFT FIRE-SAFETY STATE OF THE ART

OAET

PREVENTION

- LARGE DATABASE AVAILABLE ON ACCEPTABLE "NON-FLAMMABLE" MATERIALS
- NASA TEST METHODS UNDER EVALUATION BY NIST; MODIFICATIONS ARE SUGGESTED
- RECENT RESEARCH DEFINED LOW-GRAVITY FLAMMABILITY LIMITS AND VENTILATION EFFECTS

FIRE DETECTION

- AIRPLANE SMOKE DETECTOR DESIGNS ADAPTED TO SPACECRAFT
- NO SPACE-RELATED DATA

FIRE EXTINGUISHMENT

- SPACECRAFT EXTINGUISHING AGENTS SELECTED BY SYSTEM ANALYSES
- RECENT RESEARCH DEFINED RELATIVE EFFICIENCY OF AGENTS AS ATMOSPHERIC SUPPRESSANTS

CURRENT PRACTICES IN FIRE PREVENTION FOR SPACECRAFT

- LIMITING MATERIALS, AS FAR AS PRACTICAL, TO THOSE THAT ARE "NON-FLAMMABLE", BASED ON NHB 8060.1 FLAMMABILITY TESTS
- AVOIDANCE OF IGNITION SOURCES, THROUGH ELECTRICAL INSULATION AND GROUNDING, OVERPRESSURE CONTAINMENT, AND THERMAL/ELECTRICAL OVERLOAD PROTECTION
- GOOD HOUSEKEEPING PRACTICES FOR WASTE STORAGE AND DISPOSAL, FLUID LEAK PREVENTION, "FLAMMABLES" ISOLATION, AND SO ON

NASA ELECTRICAL WIRE INSULATION FLAMMABILITY TEST NHB 8060.1C TEST 4

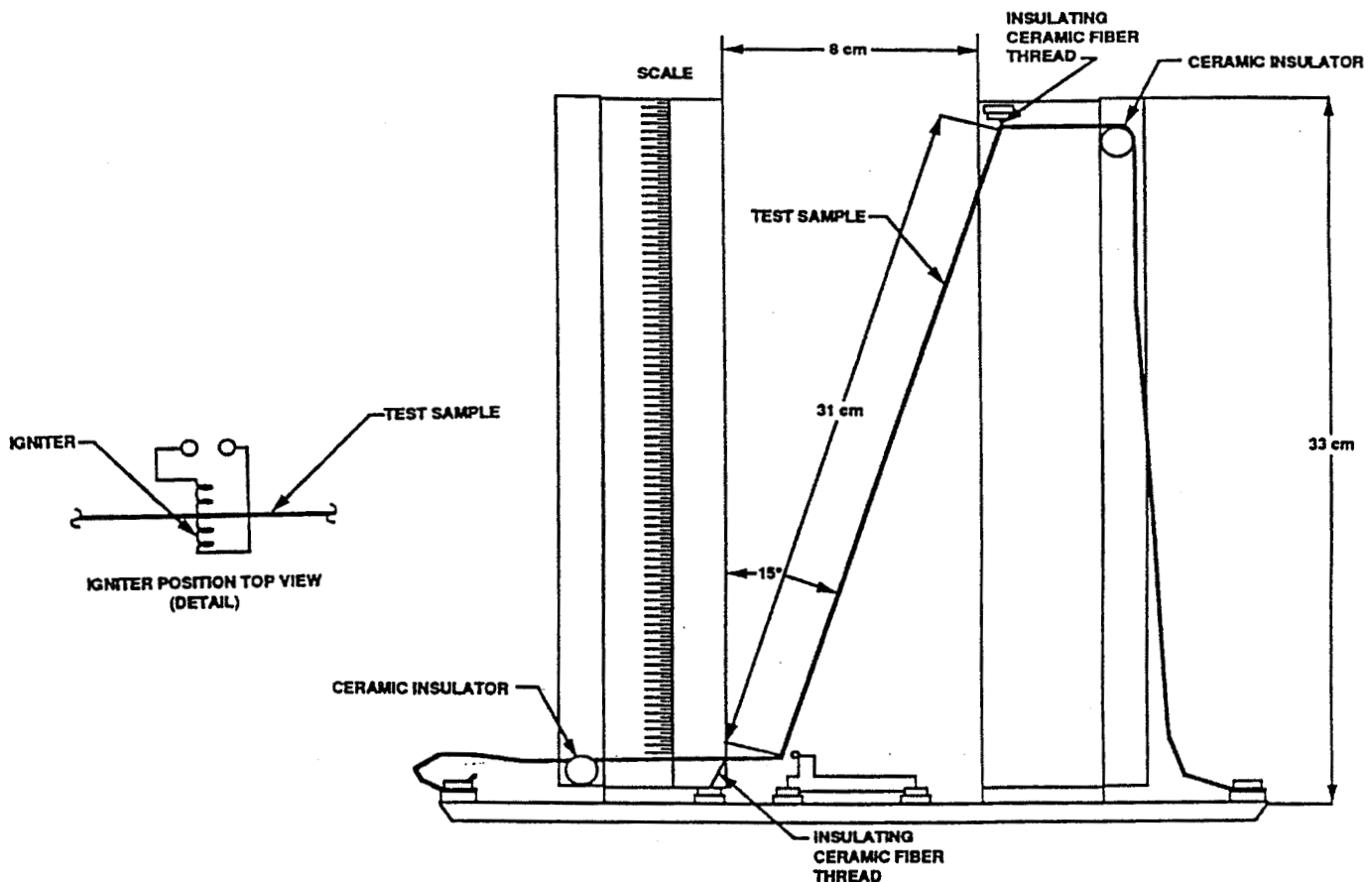

PROBLEMS IN FIRE PREVENTION FOR SPACECRAFT

- MANY COMMON ITEMS, PARTICULARLY COMMERCIAL INSTRUMENTS AND PERSONAL USE ITEMS, CANNOT PASS THE FLAMMABILITY TEST. THESE ARE PERMITTED ONBOARD SPACECRAFT WHEN CONTROLLED THROUGH ISOLATION, STORAGE PROTECTION, OR BARRIERS. NEVERTHELESS
 - CONFIGURATION CHANGES MAY OCCUR DURING MISSIONS
 - FOAM MATERIALS, VELCRO PATCHES, ETC., POSE SPECIAL FLAMMABILITY PROBLEMS (SMOLDERING, PARTICLE EXPULSION)
- MATERIAL FIRE HAZARDS MAY INCREASE IN THE FUTURE FOR *FREEDOM*
 - GREATER VARIETY OF COMMERCIAL AND TEST MATERIALS
 - HIGHER PROBABILITY OF EXPOSURE TO IGNITION "INCIDENTS"
 - CHANGES AND RELAXATION OF SAFETY ATTITUDES (LONG MISSIONS)
- CURRENT UNDERSTANDING OF MICROGRAVITY COMBUSTION QUESTIONS THE RELEVANCE OF NORMAL-GRAVITY-TEST ACCEPTANCE STANDARDS TO LOW-GRAVITY FLAMMABILITY BEHAVIOR

CURRENT PRACTICES IN FIRE DETECTION FOR SPACECRAFT

- SHUTTLE IS EQUIPPED WITH NINE STATE-OF-THE-ART IONIZATION SMOKE DETECTORS (CARGO-BAY LABORATORIES HAVE SIX OR MORE ADDITIONAL DETECTORS)
- SHUTTLE DETECTORS HAVE INTERNAL FANS FOR PARTICLE SEPARATION (DUST PARTICLE BYPASS OF IONIZATION CHAMBER) AND FOR ADEQUATE ATMOSPHERIC SAMPLING
- SHUTTLE DETECTORS ARE MONITORED TO MEASURE PARTICLE CONCENTRATION AND TO ALARM AT PRESET CONCENTRATIONS

FIRE DETECTION IN THE SHUTTLE

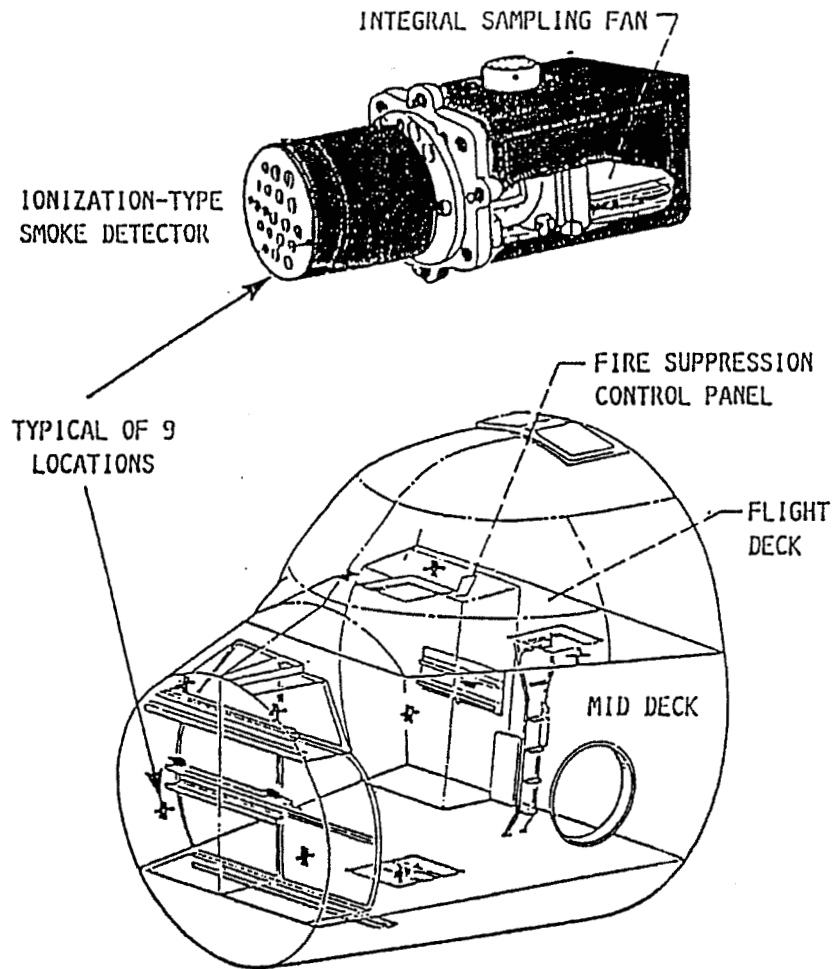

PROBLEMS IN FIRE DETECTION FOR SPACECRAFT

- THE EFFECTIVENESS OF STANDARD SENSORS IN RESPONDING TO THE UNIQUE CHARACTERISTICS OF MICROGRAVITY FIRES IS UNCERTAIN
 - SMOKE AND AEROSOL PARTICLE SIZE, SIZE DISTRIBUTION, AND DENSITY ARE UNKNOWN
 - MICROGRAVITY FLAMES ARE STEADY (FLICKER CIRCUITS DO NOT IDENTIFY THESE FLAMES)
 - THE HEAT AND MASS TRANSPORT OF FIRE "SIGNATURES" TO THE SENSOR ARE DIFFERENT, INFLUENCING RESPONSE TIMES
- SPECIFIC FIRE SCENARIOS AND RISK MODELS, NECESSARY TO GUIDE OPTIMUM SENSOR SPACING AND LOCATION, ARE LACKING
- TRADEOFFS FOR OPTIMUM DECISIONS ON SENSITIVITY VS. FALSE ALARMS, MANUAL VS. AUTOMATED RESPONSES, AND SO FORTH, ARE LACKING

CURRENT PRACTICES IN FIRE EXTINGUISHMENT FOR SPACECRAFT

- SHUTTLE EQUIPPED WITH THREE FIXED AND FOUR PORTABLE STATE-OF-THE-ART HALON 1301 FIRE EXTINGUISHERS
- OPERATION OF FIXED EXTINGUISHER FROM PANEL REQUIRES ACTUATION OF AN "ARM" SWITCH FOLLOWED BY THE "DISCHARGE" SWITCH
- NORMAL COMBUSTION PRODUCTS OF CO₂ AND WATER ARE REMOVED FROM THE ATMOSPHERE BY THE PRESENT ENVIRONMENTAL CONTROL SYSTEM
- OTHER COMBUSTION PRODUCTS, SUCH AS CO, ARE REMOVABLE, IN TRACE QUANTITIES ONLY, BY AN ACTIVATED CARBON FILTER
- MISSION WOULD BE TERMINATED AFTER EXTINGUISHER DISCHARGE FOR SUBSEQUENT GROUND CLEANUP

FIRE EXTINGUISHMENT IN THE SHUTTLE

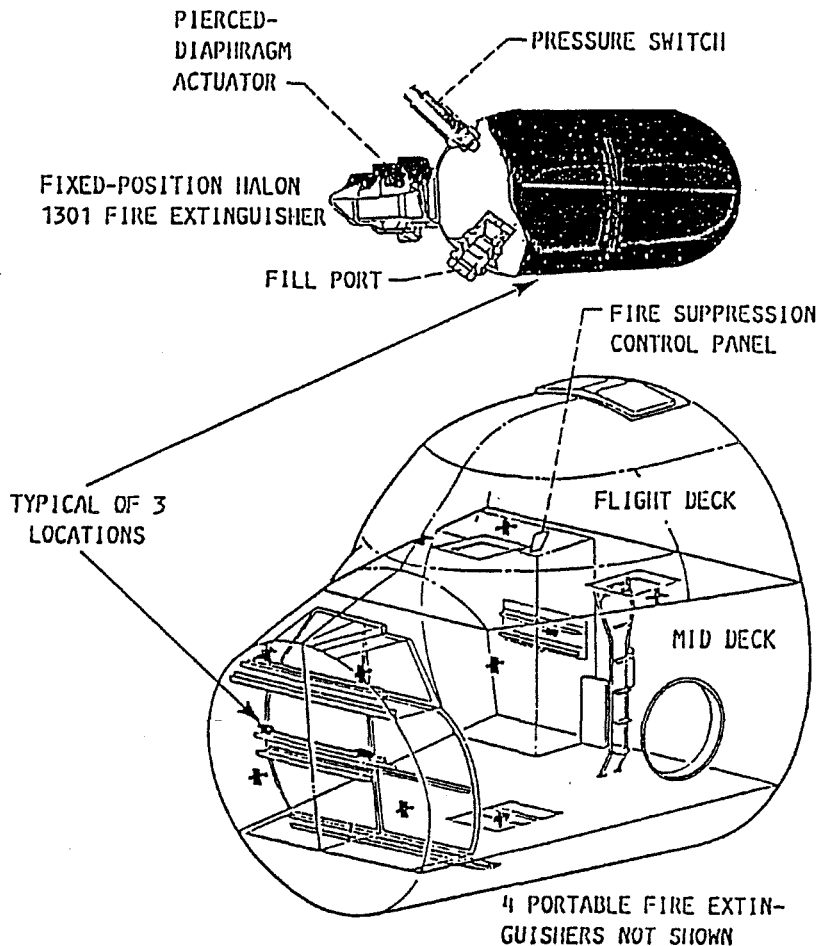

SPACE STATION *FREEDOM* FIRE PROTECTION

MAJOR ISSUES

- THE COMPLEX CONFIGURATION, VARIED CREW ACTIVITIES, AND SCIENTIFIC AND COMMERCIAL OPERATIONS MAY PROVIDE ADDITIONAL FIRE HAZARDS. THE LONG-TERM, PERMANENT ORBITAL MISSION INCREASES THE PROBABILITY OF FIRE "EVENTS" TO NEAR UNITY.
- THE INITIAL ASSEMBLY PERIOD POSES PARTICULAR CONCERNS
 - NO MEANS OF REMOTE MODULE ISOLATION OR FIRE CONTROL TO COMBAT FIRE EVENTS DURING INTERIM UNATTENDED TIMES
 - INCREASED MATERIAL FLAMMABILITY IN HIGHER-O₂-CONCENTRATION ATMOSPHERES (REQUIRED FOR EXTRAVEHICULAR ACTIVITIES)
- THE DEPENDENCIES AND TRADE-OFFS BETWEEN MANUAL AND AUTOMATED FIRE PROTECTION ARE UNRESOLVED. THE AUTOMATED DATA MANAGEMENT SYSTEM MAY FAIL DURING A FIRE, FOR EXAMPLE.
- THE APPLICATION OF THE LIMITED KNOWLEDGE OF LOW-GRAVITY FIRE BEHAVIOR TOWARD PRACTICAL FIRE-PROTECTION HARDWARE AND OPERATIONS FOR SPACE IS STILL IN A VERY EARLY STATE OF DEVELOPMENT
- SEVERE DESIGN CONSTRAINTS ON POWER, MASS, AND VOLUME DEMAND SIMPLE YET HIGHLY EFFICIENT DETECTION-SUPPRESSION SYSTEMS

SUMMARY

~~CAET~~

- **PRESENT STATUS** CURRENT SPACECRAFT FIRE-SAFETY PRACTICES, BASED MAINLY ON SKILLED APPLICATIONS OF GROUND AND AIRCRAFT TECHNIQUES, ARE CONSIDERED ADEQUATE
- **ISSUES** FOR FUTURE SPACECRAFT AND MISSIONS, HOWEVER, ADVANCES IN FIRE-SAFETY STANDARDS AND TECHNOLOGY ARE ESSENTIAL
 - THE GROWING BODY OF KNOWLEDGE OF MICROGRAVITY COMBUSTION SCIENCE OFFERS THE OPPORTUNITY FOR IMPROVED AND MORE EFFICIENT FIRE-SAFETY TECHNIQUES
 - THE COMPLEX, PERMANENT ORBITAL OPERATIONS OF *FREEDOM* IMPOSE NEW DEMANDS ON FIRE SAFETY AND INCREASE THE PROBABILITY OF FIRE INCIDENTS
 - NEW INFORMATION IS NEEDED ON THE APPLICATION OF MICROGRAVITY COMBUSTION SCIENCE AND QUANTITATIVE RISK ASSESSMENTS TO PRACTICAL CONCEPTS OF FIRE SAFETY
- **BENEFITS** RESEARCH AND TECHNOLOGY IN SPACECRAFT FIRE SAFETY PROMISE REDUCED RISK FACTORS AND IMPROVED FLEXIBILITY AND EFFICIENCY IN SPACECRAFT TECHNIQUES TO PROMOTE GREATER MISSION SAFETY AND ENCOURAGE BETTER UTILIZATION OF FUTURE SPACECRAFT

COMPARISON OF FLAMES ON THIN SOLID SURFACES (PAPER, FOR EXAMPLE)

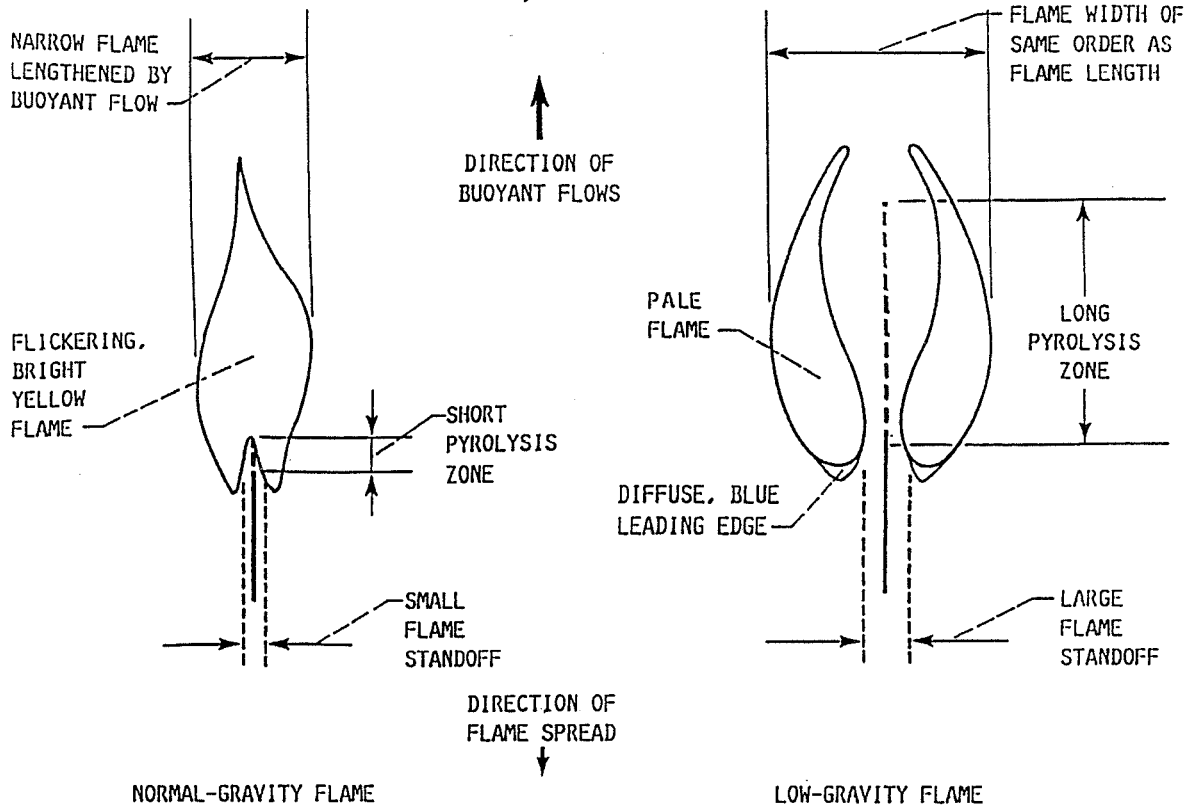

POTENTIAL ENHANCEMENT OF FLAMMABILITY BY LOW AIR FLOWS AT LOW GRAVITY

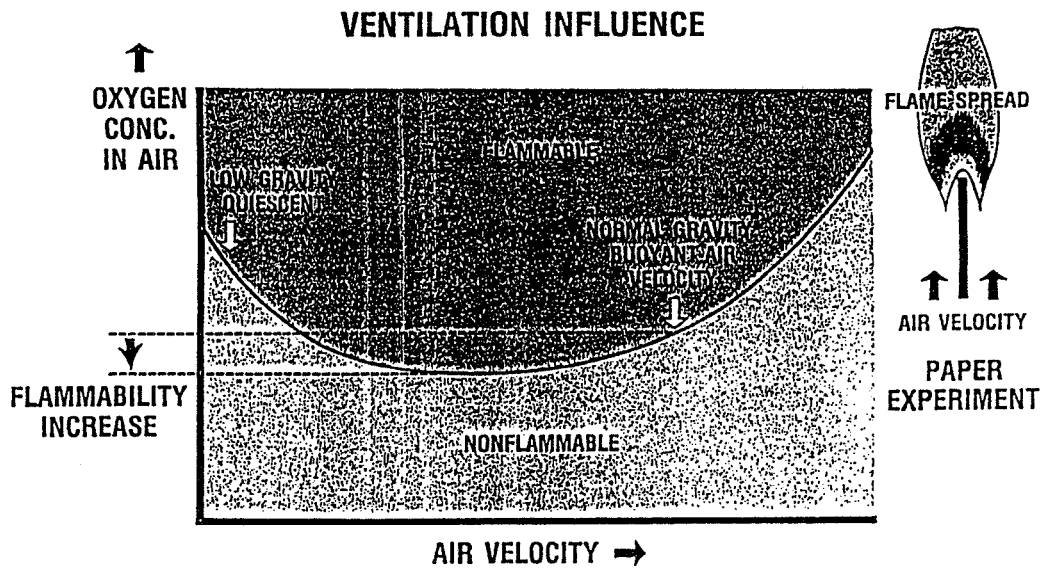

ORIGINAL PAGE IS
OF POOR QUALITY

SOLID SURFACE COMBUSTION EXPERIMENT APPARATUS

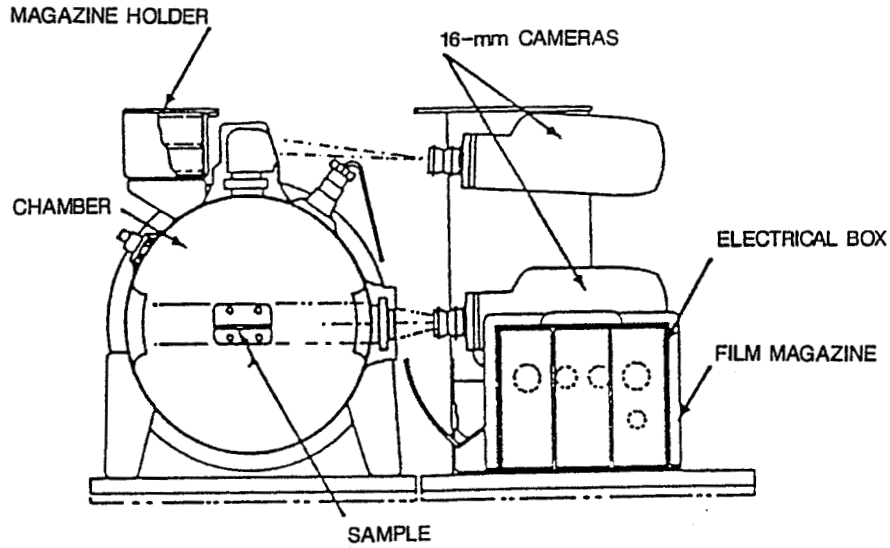

GLOVEBOX EXPERIMENTS ON THE SHUTTLE

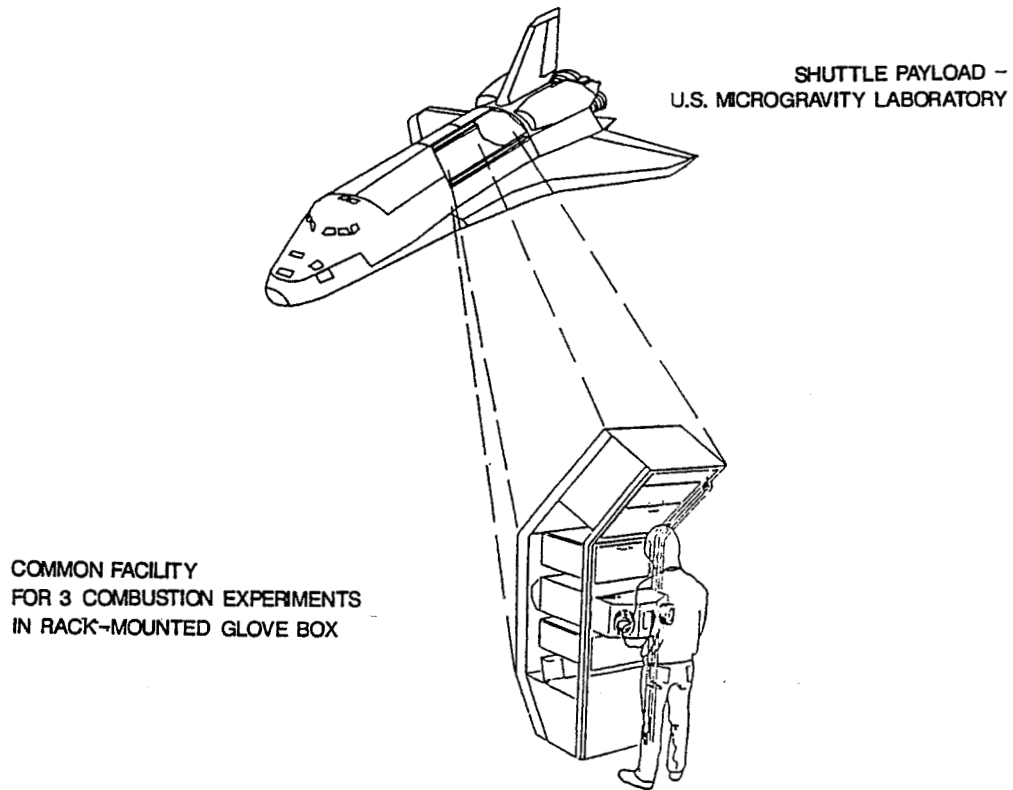

PROBLEMS IN FIRE EXTINGUISHMENT FOR SPACECRAFT

- LIMITED SELECTION OF USEFUL EXTINGUISHING AGENTS FOR SPACE
 - NONGASEOUS OR MIXED-PHASE (FOAM) TYPES NOT SUITABLE
 - REMOVAL OF AGENT AND PRODUCTS FROM CLOSED ENVIRONMENT IS A CRITICAL CONCERN
- HALON 1301 AND SIMILAR HALOCARBONS ARE TO BE PHASED OUT OF USE IN NEXT DECADE BY INTERNATIONAL AGREEMENTS
- EFFECTIVENESS OF AGENT DISPERSAL AND DELIVERY MODE UNDER THE DIFFERING MASS AND HEAT TRANSPORT RATES IN MICROGRAVITY HAVE YET TO BE DEMONSTRATED
- FOR THE PERMANENT ORBITAL MISSIONS OF *FREEDOM*, UNKNOWN LONG-TERM TOXIC AND CORROSIVE EFFECTS OF AGENT AND PRODUCT RESIDUES ARE A CONCERN

EXPERIMENTAL STUDIES AND DEMONSTRATIONS OF MICROGRAVITY FIRE BEHAVIOR RELEVANT TO FIRE SAFETY

<u>IN SPACE</u>	SKYLAB SHUTTLE SSCE (STS 41, 40)	1974 1990, 1991
<u>PARABOLIC AIRPLANE FLIGHTS</u>	KIMZEY NASA LEWIS, ESA	1966 CURRENT
<u>FREE-FALL DROP TOWERS</u>	NASA LEWIS 5.2 SEC: WIRE INSULATION SOLID SAMPLES	1971 1974 TO CURRENT
	NASA LEWIS 2.2 SEC: SOLID SAMPLES PARTICLE CLOUDS PREMIXED GASES	1970 TO CURRENT 1979 TO 1990 1980 TO CURRENT
	VARIOUS UNIVERSITY (1.0 TO 1.4 SEC): DROPLETS, AEROSOLS	CURRENT

SESSION III:

WIRING REQUIREMENTS

NASA WIRING FOR SPACE APPLICATIONS PROGRAM

JULY 23-24, 1991

**DR. DANIEL R. MULVILLE
DIRECTOR, TECHNICAL STANDARDS DIVISION
NASA HEADQUARTERS**

- **OBJECTIVES**

- **IMPROVE SAFETY, PERFORMANCE, AND RELIABILITY OF WIRING SYSTEMS FOR SPACE APPLICATIONS**
- **DEVELOP IMPROVED WIRING TECHNOLOGIES FOR NASA FLIGHT PROGRAMS**

- **APPROACH**

- **IDENTIFY REQUIREMENTS/NEED FOR FUTURE NASA PROGRAMS**
- **CHARACTERIZE EXISTING SYSTEMS**
- **DEVELOP QUALIFICATION TEST METHODS AND STANDARDS**
- **DEVELOP DATA TO SUPPORT CERTIFICATION**
- **TRANSFER TECHNOLOGY TO NASA FLIGHT PROGRAMS**

**NASA WORKSHOP ON WIRING
FOR SPACE APPLICATIONS**

● **MEETING TOPICS**

- NEAR-TERM NASA SPACE MISSIONS AND WIRING REQUIREMENTS
- EXISTING CANDIDATE WIRING SYSTEMS
- DATA BASE ON EXISTING CANDIDATE WIRING SYSTEMS:
COMPLETENESS, CERTIFICATION AND ADDITIONAL NASA
UNIQUE TESTS
- LONG-TERM NASA SPACE MISSIONS AND WIRING REQUIREMENTS
- WIRING TECHNOLOGIES UNDER DEVELOPMENT
- NASA UNIQUE TESTING REQUIREMENTS
- TECHNOLOGIES WHICH MAY SUPPORT FUTURE REQUIREMENTS,
I.E. ADVANCED PROTECTION CIRCUITRY

● **PLANNED ACTIVITIES**

- NASA WORKSHOP ON WIRING FOR SPACE APPLICATIONS – JULY 1991
 - NASA REQUIREMENTS
 - STATUS OF CURRENT WIRING TECHNOLOGY
 - IDENTIFICATION OF REQUIRED NASA PROGRAM EFFORTS
- FORMULATE APPLIED TECHNOLOGY PROGRAM TO ADDRESS NASA
NEEDS – NEAR TERM AND FAR TERM – AUGUST/SEPTEMBER 1991
- REVIEW/APPROVE PROGRAM PLAN – OCTOBER 1991

● **AEROSPACE WIRING SYSTEM PROGRAM (\$K)**

<u>FY 91</u>	<u>FY 92</u>	<u>FY 93</u>	<u>FY 94</u>	<u>FY 95</u>	<u>FY 96</u>
80	320	450	700	650	450

5
N95-16051

30143

P. 4

109636

352967

SPACE STATION FREEDOM PRIMARY POWER WIRING REQUIREMENTS

THOMAS J. HILL
ENGINEERING DIRECTORATE
NASA - LEWIS RESEARCH CENTER

SPACE STATION FREEDOM PROGRAM REQUIREMENTS

- 30 YEAR RELIABLE SERVICE LIFE IN LOW EARTH ORBIT IN HARD VACUUM OR PRESSURIZED MODULE SERVICE WITHOUT DETRIMENTAL DEGRADATION.
- IN ENGINEERING TERMS, THIS IS:
 - 263,000 HOURS SERVICE OVER 175,000 ORBITS.
 - PREDICTED THERMAL CYCLES OF 0 TO 100 DEG. C EXPOSED, OR UP TO 30 % OXYGEN INTERNAL.
 - TOTAL MASS LOSS MUST BE < 1%
 - VOLATILE CONDENSIBLE MATERIAL < 0.1% OR LESS
 - MUST SURVIVE PREDICTED HOSTILE ENVIRONMENTS: ATOMIC OXYGEN, VACUUM ULTRA-VIOLET, PLASMA, RADIATION, AND MICROMETOROIDS.
 - MUST RETAIN GOOD MECHANICAL AND ELECTRICAL PROPERTIES AT END-OF-LIFE.

SSF PRIMARY POWER
SPECIFIC REQUIREMENTS

- WORK PACKAGE 4 /ROCKETDYNE DESIGN FOR POWER DISTRIBUTION IS BASED ON POWER QUALITY, VOLTAGE DROP CONSIDERATIONS. WIRE GAGES #4 AND #1/0 WERE SELECTED.
- INSULATION TRADE STUDIES WERE RUN TO SELECT THE BEST CANDIDATES FOR PRIMARY POWER WIRES.
 - POLYIMIDE WAS EXCLUDED EARLY BECAUSE OF MECHANICAL STIFFNESS IN #4 AND #1/0 GAGES.
 - FLUOROPOLYMER (MIL-STD-22759-41) AND SILICONE OFFER BEST PROPERTIES SO FAR. AGEING TESTS ARE BEING RUN ON ALL CANDIDATES.
 - ALL INSULATIONS DEGRADE UNDER AO, VUV, MM, ETC. WP-4 WILL ENCLOSE ALL PRIMARY WIRING IN CONDUIT.

SSF CABLE INSULATION
SPECIFIC REQUIREMENTS

- ELECTRICAL PROPERTIES- TO END OF LIFE
 - GOOD DIELECTRIC STRENGTH (180 VDC MAX)
 - HIGH INSULATION RESISTANCE
 - HIGH DRY ARC TRACKING RESISTANCE
- MECHANICAL PROPERTIES- TO END OF LIFE
 - LIGHT WEIGHT FOR REQUIRED WALL THICKNESS
 - HIGH ABRASION RESISTANCE
 - FLEXIBILITY, FLEX LIFE, COLD BEND TO -100 DEG. C
 - 200 DEG. C OPERATING TEMPERATURE RATING
 - LONG LIFE AT 100 DEG. C PREDICTED TEMPERATURE
 - OFFGASSING, TOXICITY, FLAMMABILITY TESTS
 - ATOMIC OXYGEN + VACUUM-ULTRA VIOLET, PLASMA, RADIATION RESISTANT
 - FOR MODULES, 30 % OXYGEN @ 10 PSI FLAME TEST

SSF PRIMARY POWER CABLE STATUS

- BY FAR, THE MOST SIGNIFICANT DESIGN REQUIREMENT IMPOSED ON SSF POWER CABLES IS 30 YEAR LIFETIME IN SPACE ENVIRONMENT.
- THE ROCKETDYNE - WP-4 PLAN IS TO DERIVE LONG TERM THERMAL CYCLING DATA AND A LIFE PREDICTION METHODOLOGY BASED ON TESTING.
- WP-04 - ROCKETDYNE DECISION TO ENCLOSE CABLE IN CONDUIT RELIEVES MANY EROSION/IMPACT ISSUES, BUT SUCH TESTS WILL BE RUN ANYWAY.
- ROCKETDYNE MATERIALS AND PROCESSES EXPERTS ARE WORKING WITH THEIR SCIENCE CENTER TO DEVISE THERMAL CYCLE, TENSILE, AND AGEING TESTS TO APPLY TO ALL CANDIDATE INSULATIONS.

WP-4 PLANNED CABLE TEST PROGRAM

- INSULATION TESTS, MULTIPLE SAMPLES, ALL CANDIDATES:
 - LONG TERM MECHANICAL CYCLING OF SAMPLE,
 - LONG TERM THERMAL CYCLING OF SAME SAMPLE,
 - TORSION PENDULUM TEST TO DETECT DEGRADATION.
- CABLE TEST PROGRAM
 - THERMAL MODEL FOR EACH CONFIGURATION.
 - SCALED VACUUM CHAMBER TESTS TO VERIFY MODEL.
 - RADIATED EMISSIONS TESTS OF CABLES AND GROUND.
 - TESTING FOR EVA COMPATIBILITY.
 - PRODUCTION TESTS FOR PRODUCIBILITY/HANDLING.
 - FLIGHT CONFIG. CABLES USED FOR GROUND TESTS.
- A SPECIAL TEST IS PROPOSED FOR LONG CABLE RUNS TO MEASURE EXPANSION AND CONTRACTION EFFECTS.

ROCKETDYNE-WP04 PRIME INSULATION CANDIDATES

- THE SSQ SPECIFICATION FOR POWER WIRE AND CABLE IS SSQ 21656
- ETFE (ETHYLENE-TETRAFLUOROETHYLENE COPOLYMER) IS DUPONT (R) TEFZEL.
- XL-ETFE IS A CROSSLINKED VERSION OF TEFZEL PER ROCKETDYNE SPECIFICATION RE2432. THIS IS SIMILIAR TO MIL-W-22759-41, BUT MODIFIED TO USE FINER STRANDS, MORE FLEXIBLE TEFZEL, AND NO OUTER BRAIDED JACKET.
- THE SILICONE INSULATION CANDIDATES INCLUDE MDAC PROVIDED GENERAL ELECTRIC SE6660, PHENYL-DIMETHYL (PVMQ).

OTHER DATA, LIMITS, AND TEST-TO PARAMETERS AT THIS TIME, SUBJECT TO CHANGE

- ATOMIC OXYGEN REFERENCE FLUX: $4.1E+14$ AO/CM SQ-SEC
- ARC TRACKING: TEST PER NASA NHB 8060.1C TEST 18
- RADIATION: 30 YEAR EXPOSURE $3.6E+4$ RADS
- PLASMA: DESIGN REFERENCE PLASMA $4.5E+6$ IONS/CM³
- FLAMMABILITY: NO FLAME SUPPORT, NASA NHB 8060.1C 401 #1 AT 10 PSIA 30% OXYGEN.
- OUTGASSING: UNLESS ALREADY TESTED AND DATA SUBMITTED FOR INCLUSION INTO MSFC-HDBK-527/JSC 09604, SAMPLES SHALL BE TESTED TO NASA JSC SP-R-0022, AND DATA SUBMITTED TO NASA FOR EVALUATION.
- OFFGASSING: MATERIAL SAMPLES SHALL BE TESTED PER NASA NHB 8060.1C, 407 TEST 7. MAXIMUM ALLOWABLE CONCENTRATION (MAC) VALUES IN APPENDIX D ARE NOT TO BE USED AS PASS/FAIL CRITERIA, BUT DATA SUBMITTED TO NASA FOR EVALUATION.



109637
352968

N95-16052

NASA
National Aeronautics and
Space Administration

3014
P-1

George C. Marshall Space Flight Center

SPACE STATION FREEDOM SECONDARY POWER WIRING REQUIREMENTS

C. R. SAWYER
LEAD ENGINEER
INTERCONNECTING CABLING
SPACE STATION PROGRAM
WORK PACKAGE 1

BOEING AEROSPACE & ELECTRONICS COMPANY
HUNTSVILLE DIVISION
HUNTSVILLE, ALABAMA

SECONDARY POWER - WHAT IS IT?

- SSF POWER TYPES

- PRIMARY - POWER PRODUCED BY THE ARRAY & ROUTED TO DC-TO-DC POWER CONVERTER UNITS
- SECONDARY - POWER PRODUCED BY DDCU'S & ROUTED TO THROUGH SPDA'S TO LOADS OR TERTIARY DISTRIBUTION ASSEMBLIES
- TERTIARY - POWER ROUTED THROUGH TERTIARY POWER DISTRIBUTION ASSEMBLIES TO LOADS

FOR PRACTICAL PURPOSES SECONDARY & TERTIARY POWER
ARE THE SAME, I.E. SECONDARY POWER

SPACE STATION FREEDOM ELECTRICAL POWER CATEGORIES

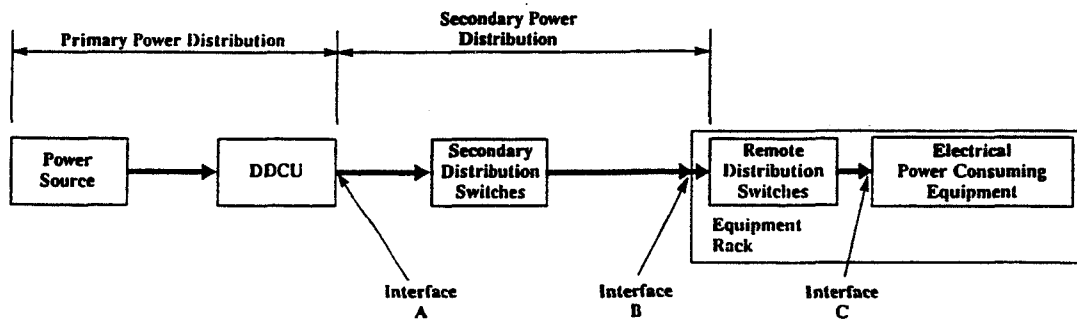

DIFFERENCES BETWEEN SECONDARY & TERTIARY POWER

- ELECTRICALLY - NO DIFFERENCE
 - NO FURTHER CONDITIONING OF POWER IN TERTIARY POWER DISTRIBUTION ASSEMBLIES
 - SAME VOLTAGE LEVELS AT TERTIARY POWER DISTRIBUTION ASSEMBLY OUTPUTS AS SECONDARY POWER DISTRIBUTION ASSEMBLY OUTPUTS
- PHYSICALLY
 - SECONDARY POWER IS POWER DISTRIBUTED FROM DC-TO-DC POWER CONVERTER UNITS TO TERTIARY POWER DISTRIBUTION ASSEMBLIES THROUGH SECONDARY POWER DISTRIBUTION UNITS
 - TERTIARY POWER IS POWER DISTRIBUTED FROM TERTIARY POWER DISTRIBUTION ASSEMBLIES OR SECONDARY POWER DISTRIBUTION ASSEMBLIES TO LOADS

SPACE STATION FREEDOM
EEE PARTS WIRE SELECTION
REQUIREMENTS

- SSP 30000, SECTION 9 SELECTION CRITERIA
 - SUITABILITY FOR APPLICATIONS
 - PROVEN QUALIFICATION
 - POTENTIAL USE IN MULTIPLE APPLICATIONS
 - PROVEN TECHNOLOGY
 - AVAILABILITY
 - APPROVAL STATUS

SPACE STATION FREEDOM
APPROVED ELECTRICAL
WIRE & CABLE

- STANDARD WIRE & CABLE - GRADE 1 WIRE & CABLE LISTED IN MIL-STD-975 & SSP 30423
 - M22759/11, /12, /16, /23 & /3
 - M81381/7, /8, /9, /10 & /21
 - M27500 TYPES RC, RE, TE, TM, TN, MR, MS, MT, MV & NK
- NEW PROGRAM STANDARDS - BEING ADDED TO SSQ 30423
 - SSQ 21656
 - SSQ 21655

SPACE STATION FREEDOM
PDRD LANGUAGE PROBLEMS

- PDRD STATES APPROVED PARTS ARE LISTED IN MIL-STD-975 & SSP 30423
 - INFERS TO DESIGNERS LISTED WIRE & CABLE MEET ALL OF THE REQUIREMENTS OF SPACE STATION
 - MIL-STD-975 DOES NOT DIFFERENTIATE BETWEEN WHAT IS ACCEPTABLE/NOT ACCEPTABLE BY PROJECT
 - MIL-STD-975 IS NOT UP TO DATE WITH CURRENT PART TECHNOLOGY
 - MIL-STD-975 SPECIFIES SUNSET WIRE & CABLE CONFIGURATIONS NECESSARY TO SUPPORT CURRENT, ONGOING PROJECTS

SPACE STATION FREEDOM
PDRD LANGUAGE PROBLEM
RESOLUTION

- DIRECT USE OF SPECIFIC WIRE & CABLE TYPES IN ALL NEW DESIGN SPACE STATION EQUIPMENT BASED ON APPLICATION
 - JOINT WORK PACKAGE CONNECTOR GROUP HAS RECOMMENDED TEFLON, TEFZEL & SILICONE INSULATIONS BASED ON APPLICATION & PERCIEVED NASA DESIRES
- REVISE THE LANGUAGE IN THE PDRD FOR CLARITY
 - *"MIL-STD-975 lists standard EEE parts used in various NASA projects that have been found to be suitable for high reliability space applications and shall be used as a first order of precedence in selecting Space Station parts."*

PERCEIVED NASA
REQUIREMENTS

- NO KAPTON (M81381) INSULATED WIRE OR CABLE DUE TO ARC TRACKING
- NO SILVER COATED CONDUCTOR DUE TO RED PLAGUE EXPERIENCE & POTENTIAL CORROSION PROBLEMS
- NO TEFZEL INSULATED WIRE OR CABLE IN INTERNAL MANNED VOLUMES DUE TO MARGINAL SELF-EXTINGUISHING PROPERTIES & CHAR BYPRODUCTS
- MARGINAL INSULATIONS VACUUM BAKED TO REDUCE OUTGASSING
- LITTLE-TO-NO DEVELOPMENT

CONTRACTUAL EEE PARTS
WIRE & CABLE APPLICATION
REQUIREMENTS

- ENSURE WIRE & CABLE WILL NEVER BE OVERSTRESSED DURING NORMAL OPERATION
- DERATE WIRE & CABLE IN ACCORDANCE WITH MIL-STD-975
- ENSURE ALL EXPECTED ENVIRONMENTAL CONDITIONS ARE CONSIDERED AND EVALUATED WHERE PRACTICAL
 - RADIATION
 - ATOMIC OXYGEN
 - PLASMA
 - VACUUM
 - VARYING THERMAL CONDITIONS

WIRE DERATING CRITERIA

- SSP 30000 SPECIFIES WIRE DERATING IN ACCORDANCE WITH MIL-STD-975
 - CURRENT DERATING BASED ON 200 DEGREE C WIRE OPERATING IN 70 DEGREE C IN HARD VACUUM
 - DERATED CURRENT VALUES ARE APPROXIMATELY ONE HALF OF THE CURRENT THAT WILL RAISE THE INSULATION TEMPERATURE FROM 70 DEGREES C TO 200 DEGREES C
- CONTRACTUAL DERATING IS REASONABLE BASED ON FOLLOWING CRITERIA
 - SCHEDULED MAINTENANCE PERFORMED IN PROXIMITY OF "HOT" WIRES
 - OPERATION IN EVACUATED MODULES AT FULL LOAD

INTERNAL MODULE SECONDARY POWER APPLICATIONS

- SECONDARY POWER DISTRIBUTION ASSEMBLY OUTPUT
 - DISTRIBUTE POWER TO INDIVIDUAL HOUSEKEEPING & PAYLOAD RACKS
 - DISTRIBUTE POWER TO EXORACK MOUNTED COMPONENTS REQUIRING ELECTRICAL POWER
- TERTIARY POWER DISTRIBUTION ASSEMBLY OUTPUT
 - DISTRIBUTE POWER TO RACK MOUNTED EQUIPMENT

GENERAL CONFIGURATION -
U. S. LABORATORY MODULE
ENDCONE

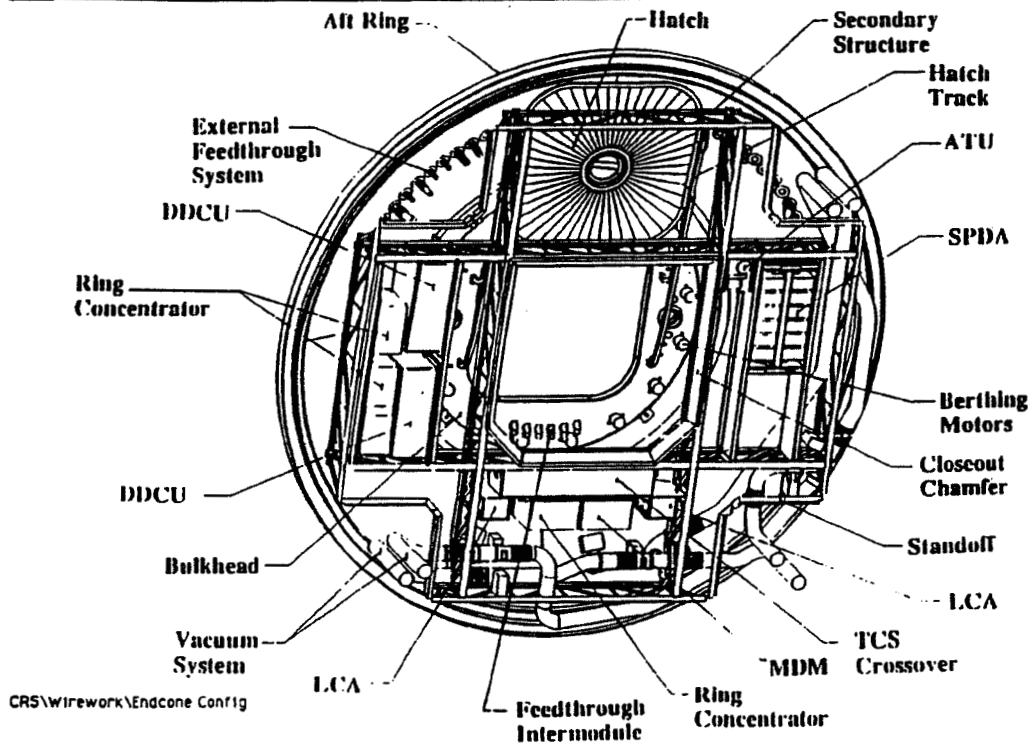

CABLE ROUTING -
SPDA TO RACK INTERFACE

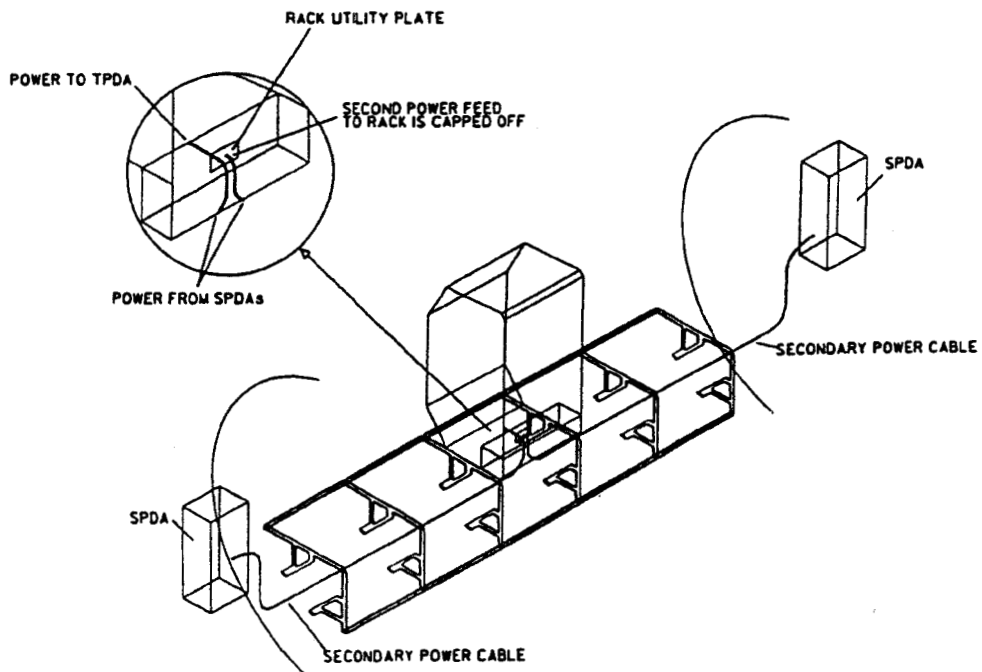

INTERNAL RACK EQUIPMENT CONFIGURATION (OPEN LOOP ARS RACK)

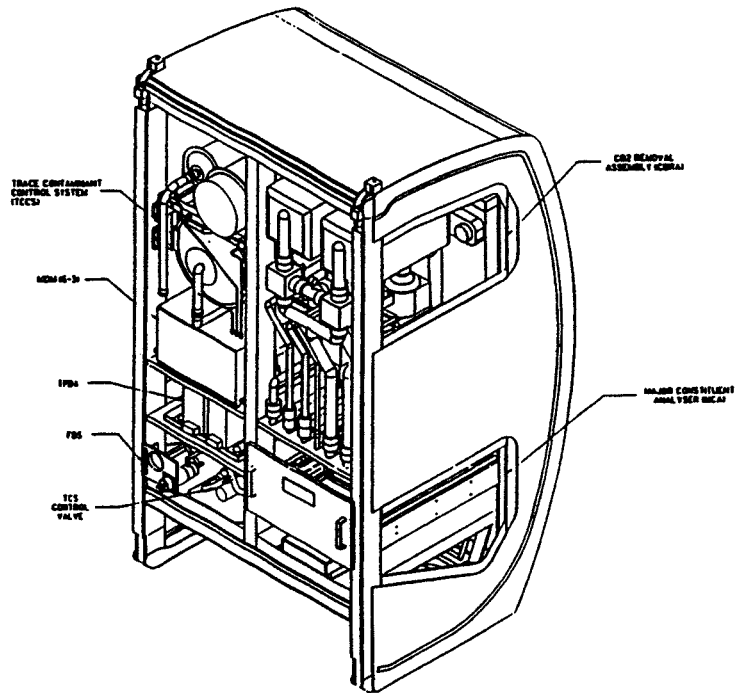

CABLE ROUTING - STANDOFF TO RACK INTERFACE (HOUSEKEEPING RACKS)

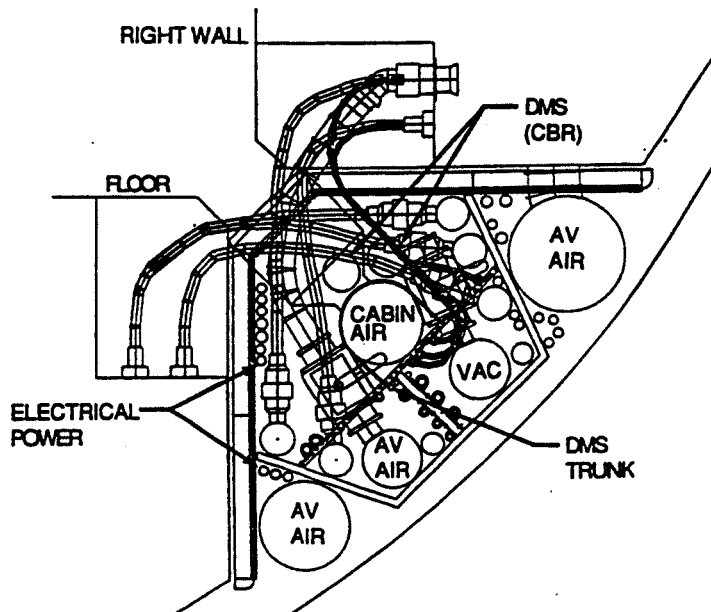

CABLE ROUTING - STANDOFF TO RACK INTERFACE (PAYLOAD RACKS)

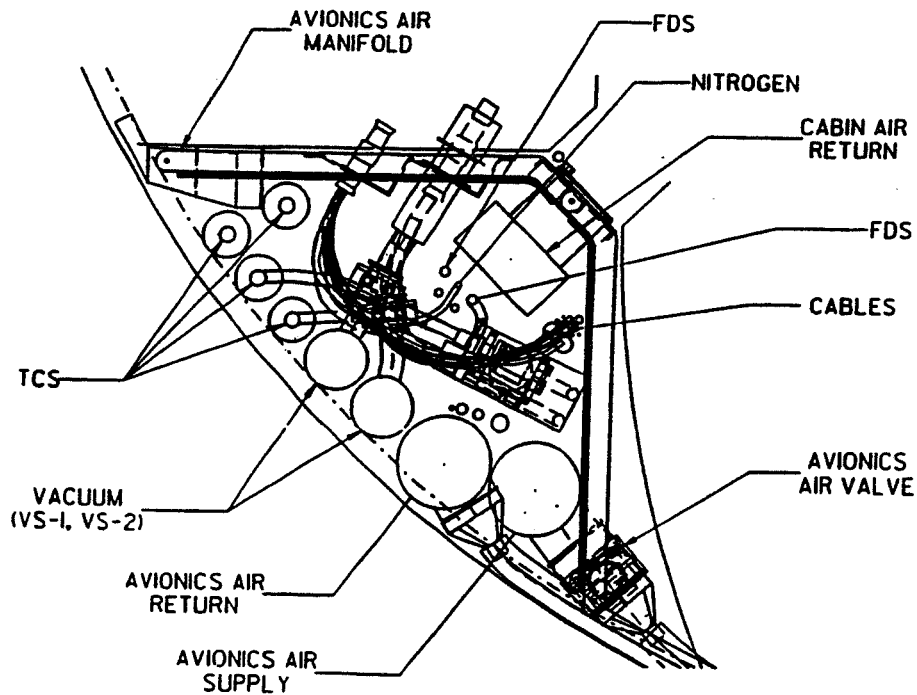

SECONDARY POWER WIRE SIZES

- WIRE SIZES ARE BASED ON CONTRACTUAL DERATING CRITERIA, NUMBER OF WIRES IN BUNDLES EXITING RPCM'S AND RPCM RATING
 - 50 A RPCM = 4 AWG
 - 25 A RPCM = 8 AWG
 - 12 A RPCM = 12 AWG
- WITH 8 12 A RPC'S IN A 12 A RPCM 12 AWG IS MARGINAL
 - ACTUAL ALLOWABLE CURRENT WITH ALL RPC'S "HOT" IS 11.5 A

JOINT WORK PACKAGE
CONNECTOR GROUP
RECOMMENDATIONS

- LARGE POWER FEEDERS (8 AWG & LARGER) REQUIRING FLEXIBILITY/FORMABILITY
 - SSQ 21652 SILICONE INSULATED WIRE
 - HIGH PICK COUNT ROPE LAY
 - HIGH SHORE SILICONE JACKET
- SMALL POWER FEEDERS (12 AWG & SMALLER) INTERNAL TO MODULES
 - SSQ 21656 TEFLON INSULATED WIRE
- SMALL POWER FEEDERS EXTERNAL TO MODULE
 - SSQ 21656 TEFZEL INSULATED WIRE

SECONDARY POWER
WIRE & CABLE DESIRED INSULATION
CHARACTERISTICS

- 200 DEGREE C RATING MINIMUM
- EXTREMELY DURABLE
- SELF EXTINGUISHING
- NON TOXIC CHAR BYPRODUCTS
- FLEXIBLE
- LOW OFFGASSING
- MINIMAL OUTGASSING
- EASY TO STRIP

**POTENTIAL WIRE
CONFIGURATIONS
(BASED ON NASA DESIRES)**

Configuration	Insulation	Conductor coating	Size AWG	Temperature rating (C)	Conductor material
M22759/3	TEFLON	NICKEL	22-2/0	260	COPPER
M22759/11	TEFLON	SILVER	28-8	260	COPPER
M22759/12	TEFLON	NICKEL	28-8	260	COPPER
M22759/16	TEFLON	TIN	24-2/0	150	COPPER
M22759/22	TEFLON	SILVER	28-20	260	HSCA
M22759/23	TEFLON	NICKEL	28-20	260	HSCA
M81381/7	KAPTON	SILVER	26-10	260	COPPER
M81381/8	KAPTON	NICKEL	26-10	260	COPPER
M81381/9	KAPTON	SILVER	30-20	260	HSCA
M81381/10	KAPTON	NICKEL	30-20	260	HSCA
M81381/21	KAPTON	TIN	26-10	150	COPPER

**M22759/3 & /12
CAVEATS**

- M22759/3 WIRE IS EXTREMELY STIFF
 - TEFLON JACKET OVER FIBERGLASS BRAID OVER TEFLON
 - STANDARD MULTI STRAND CONDUCTOR CONSTRUCTION
- M22759/12 WIRE HAS LIGHTWEIGHT TEFLON INSULATION
 - REQUIRES CARE IN FORMING, SECURING AND INSTALLATION
- M22759/3 DOES NOT COVER SIZES LARGER THAN 8 AWG

omit

ORGANIZATION MSFC/NASA	MARSHALL SPACE FLIGHT CENTER SPACE WIRING WORKSHOP ELV REQUIREMENTS	NAME: BILL McPEAK
CHART NO.: 1		DATE: JULY 1991

HISTORICAL

GROUND LAUNCHED PROPULSION VEHICLES

SATURN

- SIC AND SIVB STAGES - THICK WALL EXTRUDED TFE
- SII STAGE - MEDIUM WALL EXTRUDED TFE
- INSTRUMENT UNIT - THIN WALL EXTRUDED TFE AND FEP W/POLYIMIDE COATING

SHUTTLE

- SOLID ROCKET BOOSTER (SRB) - MEDIUM WALL EXTRUDED TFE
- SOLID ROCKET MOTOR (SRM) - MED TFE AND POLYIMIDE FILM
- SPACE SHUTTLE MAIN ENGINE (SSME) - THICK WALL EXTRUDED TFE
- EXTERNAL TANK (ET) - MED TFE INSIDE AND POLYIMIDE FILM OUTSIDE

CONDUCTORS

PREDOMINANTLY NICKEL PLATED COPPER

- FE - POLYTETRAFLUOROETHYLENE
- EP - FLUORINATED ETHYLENE PROPYLENE

ORGANIZATION MSFC/NASA	MARSHALL SPACE FLIGHT CENTER SPACE WIRING WORKSHOP ELV REQUIREMENTS	NAME: BILL McPEAK
CHART NO. 2		DATE: JULY 1991

HISTORICAL

SPACE LAUNCHED PROPULSION VEHICLES

- o INERTIAL UPPER STAGE (IUS) - POLYALKENE INTERNAL & POLYIMIDE FILM EXT.
- o TRANS ORBITAL STAGE (TOS) - POLYIMIDE FILM
- o CONDUCTORS - MIXTURE TIN, SILVER, NICKEL PLATED.

SPACELAB, ORBITAL PAYLOADS AND EXPERIMENTS

- o PREDOMINANTLY POLYIMIDE FILM
- o SOME TFE, FEP, POLYALKENE, AND HYBRID CONSTRUCTIONS
- o CONDUCTORS - MIXTURE TIN, SILVER, NICKEL PLATED

ORGANIZATION MSFC/NASA	MARSHALL SPACE FLIGHT CENTER SPACE WIRING WORKSHOP	NAME: BILL McPEAK
CHART NO 3	ELV REQUIREMENTS	DATE: JULY 1991

LAUNCH AND PROPULSION VEHICLES REQUIREMENTS

RANKING

- 1 ARC TRACKING PROOF WIRING (NO PROPAGATION)
- 2 270 Vdc OPERATION AT CRITICAL PRESSURE
2500 Vdc/rms MINIMUM AT ONE ATMOSPHERE
- 3 ABRASION/CUT-THRU/NOTCH RESISTANT
- 4 TEMPERATURE
 - 85 TO 150⁰C INTERNAL EQUIPMENT AND BOXES
 - 200 TO 200 OR 260⁰C INTERCONNECTING CABLES
 - 255 TO 200⁰C INSIDE CRYOGENIC FUEL & OXIDIZER TANKS

ORGANIZATION MSFC/NASA	MARSHALL SPACE FLIGHT CENTER SPACE WIRING WORKSHOP	NAME: BILL McPEAK
CHART NO 4	ELV REQUIREMENTS	DATE: JULY 1991

LAUNCH AND PROPULSION VEHICLE REQUIREMENTS

RANKING

- 5 RESISTANT TO AND COMPATIBLE WITH:
 - WATER/SALT WATER/HUMIDITY
 - LIQUID OXYGEN
 - LIQUID HYDROGEN AND HYDRAZENE
 - CHEMICALS
- 6 CONDUCTOR SIZES 30 THRU 0 OR EQUIVALENT
 - DATA BUS, RF, & FIBER OPTIC VERSIONS

ORGANIZATION MSFC/NASA	MARSHALL SPACE FLIGHT CENTER SPACE WIRING WORKSHOP ELV REQUIREMENTS	NAME: BILL McPEAK
CHART NO 5		DATE: JULY 1991

LAUNCH AND PROPULSION VEHICLE REQUIREMENTS

RANKING

- 7 FLAMMABILITY, ETC REQUIREMENTS OF NHB 8060.1C
- 8 NO MATERIAL FLAKING, CRACKING, OR DELAMINATION
- 9 VIBRATION 200 G'S
ORDNANCE SHOCK 30,000 G'S
- 10 BASIC REQUIREMENTS (MIL-W-22759, MIL-W-81381)
- 11 FLEXIBLE
- 12 WEIGHT/SPACE (LAST ITEM)

N95-16053

30145
P-10
109638
352969

A STUDY OF ELECTRIC TRANSMISSION LINES FOR USE ON THE LUNAR SURFACE

Krista L. Gaustad
Lloyd B. Gordon
and
Jennifer R. Weber

Space Power Institute and
Department of Electrical Engineering
Auburn University

- INTRODUCTION
- LUNAR ENVIRONMENT
- TRANSMISSION LINE DESIGN
- ELECTRICAL ANALYSIS
- THERMAL ANALYSIS
- STUDIES

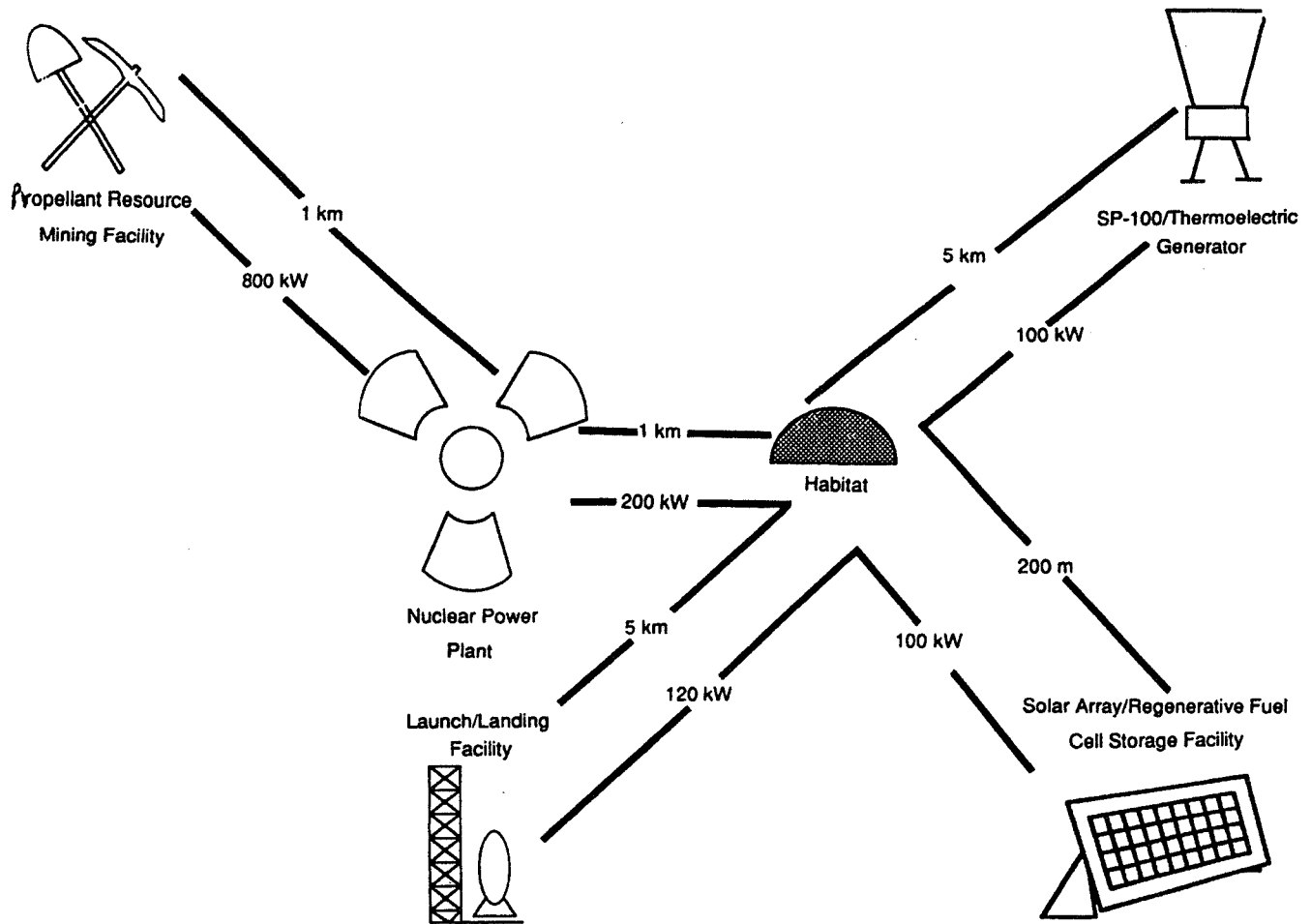

SOURCES

- **Solar/Chemical: 100 kW**
Solar Array/Regenerative Fuel Cells
- **Nuclear (Static Conversion): 100 kW**
Thermoelectric (SP-100)
Thermionic (Topaz)
- **Nuclear (Dynamic Conversion): 1 MW**
Reactor/Stirling Engine (100 Hz)
Reactor/Brayton Engine (1 to 2 kHz)

LOADS

Habitat and Research Facilities

- Wiring requirements likely to be similar to domestic and public building requirements
- Cables will be protected from harsh environment
- Voltage less than 500 V

Launch/Landing Facility

- May involve the use of heavy equipment requiring higher operating voltages.
- Chemically hostile environment (effluents)

Resource Mining

- Mining equipment may require voltages as high as 2 to 6 kV.
- Mechanically hostile environment

Cables Likely to be Required for Lunar Base Operations

- Vacuum-insulated or Solid-dielectric-insulated (oil filled will have high mass and be difficult to maintain)
- Fixed
 - wiring cables 120 - 500 V
 - industrial cables 300 - 600 V
 - power distribution 500 - 5 kV
- Flexible
 - must compromise between flexibility and ease of handling and protection against mechanical damage
- Auxiliary
 - cables used for control, protection, signalling and data transmission purposes associated with power distribution and transmission systems.
- Electronic Applications
 - communication cables
 - applications in computers, automation, robotics aerospace, and data communications
 - interconnecting cabling between individual equipments
 - coaxial cables and twisted pair

The Lunar Environment

Pressure	— 10^{-8} torr (day) down to 10^{-12} torr (night)
Radiation	
Solar	— UV, visible, infrared, x-ray, γ -ray (1371 W/m^2)
Cosmic	— High energy particles
Charged Particles	— Solar wind
Thermal	— Lunar surface temperature (100 K to 380 K)
Dust	— Mostly fine dust and silt, some coarser sands
Contamination	— Particulate and gaseous from human activities

POWER TRANSMISSION OPTIONS

- **Power Beaming**
 - required technology will probably not be ready for initial base
 - cost of development will be expensive
- **Superconducting**
 - initial uses will probably be limited to magnetic energy storage and magnetic shielding to protect against radiation.
 - will likely require the use of liquid helium to maintain low temperatures
- **Transmission Lines**
 - reliable, proven technology
 - low cost

LUNAR BASE POWER TRANSMISSION

An early application of electrical power for lunar bases will be the manufacturing of oxygen, rocket fuel, water, and building materials from lunar soil. Powers up to 1 MW will be transported several kilometers from the sources to the loads. Transmission lines must have **minimum mass, maximize efficiency, and operate reliably in the lunar environment.**

TRANSMISSION LINE DESIGN

- Conductor Material
- Insulator Material
- Conductor Geometry
- Conductor Configuration
- Line Location
- Waveform
- Phase selection
- Frequency

Possible Methods of Transmission Line Insulation

- Liquid
- Gas
- Solid
- Vacuum

Electrical Insulation

Liquid and gaseous dielectrics are undesirable for long term use in the lunar vacuum due to a high probability of loss. Thus, insulation for high voltage transmission line will most likely be solid dielectric or vacuum insulation.

	<u>Breakdown</u>	<u>Mass</u>	<u>Stresses</u>
Solid Dielectric	solid dielectric puncture permanent failure	high	thermal, vacuum, radiation
Vacuum	surface flashover or vacuum arc, recoverable	low	dust contamination gas contamination

SOLID DIELECTRIC BREAKDOWN

The electrical breakdown of solid dielectrics under room temperature conditions, and under reasonable uniform field conditions is well known for terrestrial applications. However, the environmental conditions of the lunar environment are much harsher and will lead to electrical breakdown sooner or at a lower potential.

Environmental Conditions that will Influence Solid Dielectric Breakdown:

- Thermal Stress -
Few solid dielectrics can reliably withstand the extreme temperature swings of the lunar environment.
- Vacuum Stress -
Evaporation or chemical changes which may occur as water and gases gradually diffuse out of the material may lead to degradation of solid dielectrics.
- Radiation Stress -
Radiation (UV, visible, x-ray, particle, etc.) damages most dielectrics.

VACUUM BREAKDOWN

Due to the high breakdown strength of vacuum and the need to limit system masses, vacuum insulation seems a logical option for high voltage lunar power systems.

Conditions which may degrade vacuum insulation:

Gas Contamination -

Gas contamination from rocket propulsion, manufacturing processes ect., will raise the pressure in the vicinity of the high field stress regions.

Particulate Contamination -

Significant particulate contamination between and on exposed conductors due to lunar dust and human activities may lead to volume or surface breakdown.

CONDUCTOR GEOMETRY

2 - wire
Coaxial
Flat

CONDUCTOR FORM

Solid
Hollow

Deployment Locations

- suspended
- below the surface
- on the surface

System Design Requirements

Power	- 100 kW and 1 MW
Waveform	- dc, 100 Hz, 1 kHz, and 10 kHz ac
Efficiency	- greater than 95 %
Distance	- 1 km
Radii	- 3 mm, 6 mm, and 9 mm

Design Variables

Voltage	- 100 V to 10 kV
Geometry	- Two-wire, coaxial, flat-plate
Location	- Above, on, or below the lunar surface
Materials	- Conductor (Al, Cu) - Dielectric (solid or vacuum)

Dependent Parameters

Current
Material Temp.
Electric Field Stress
Power Lost
Mass

DESIGN CONCLUSIONS

- Conductor geometry is important, especially depending on waveform.
- Operating temperature is critical and will depend on waveform, geometry, location, efficiency, and voltage.
- Higher voltages can result in significant mass, temperature, and size reductions, however, breakdown characteristics are not known well enough to predict possible breakdown conditions.
- Solid dielectrics add a substantial mass to the transmission line, especially for higher voltages.
- Operating in the lunar environment is a critical factor in transmission line design.
- It is important to study the degradation of solid dielectrics in the lunar environment, specially accounting for the synergistic effects of the vacuum, the thermal stress, and the radiation.

EXPERIMENTAL TOPICS

- The thermal characteristics of buried transmission lines.
Study the heat conduction of simulated lunar soil.
- The thermal characteristics of suspended transmission lines.
Study the heat radiation of conductors under a simulated lunar environment.
- The electrical characteristics of the lunar soil.
Study the conduction and breakdown characteristics of on-the-surface and buried conductors.
- Volume and surface breakdown in the lunar environment.
Study the motion and effects of lunar dust in electric fields.
- Electrical characteristics of lunar dust.
Study the motion and effects of lunar dust in electric fields.
- Degradation of solid dielectrics in the thermal, radiation, and vacuum.
Study the stress factors individually and synergistically for many candidate dielectrics.

ADDITIONAL CASES

- Stranded cable
- Litz wire
- Single Phase vs Three Phase

STRANDED CABLE

At low voltage/low frequency, stranding and spiraling of the line is done primarily to increase the flexibility of the line, thus improving the ease of transportation and deployment of the cable.

- Stranding creates a slight increase in weight and electrical resistance. This increase will be proportional to the increase in length caused by the spiraling.
- Typically conductors are stranded for wire diameter greater than 4/0 Awg.

LITZ WIRE

Litz wire consists of individually insulated strands of wire woven together such that each strand tends to take all possible positions in the cross section of the entire conductor.

- The primary benefit of Litz conductor is the reduction of a.c. losses. (the resistance ratio a.c. to d.c. is approximately one).
- The primary design concern is the operating frequency. It determines both the construction of the cable and the wire gauge of the individual strands.
- Accurate thermal analyses will be difficult.
- Litz configurations:
 - round
 - braided
 - rectangular
 - square

SINGLE PHASE VS THREE PHASE

- 1- \emptyset , 3-wire and 3- \emptyset , 4 wire designs have the same maximum possible power transmitted. (Assuming an equal amount of conductor material is used to both cases).
- 1- \emptyset , 3-wire will continue to operate at reduced power should one line fail.
- 3- \emptyset is less pulsating. (This is advantages for motor loads because it produces more uniform torque).
- 3- \emptyset equipment is physically smaller in size than similar single phase equipment.
- Three 1- \emptyset lines can be derived from 3- \emptyset giving it more distribution flexibility.
- The addition of more lines will increase the mass due to the additional insulators required.
- Generating 3- \emptyset may require more equipment and be more complicated than generating 1- \emptyset from the proposed sources.

KAPTON PYROLYSIS, THE SPACE ENVIRONMENT AND WIRING REQUIREMENTS

30146
P. B
109639
352990

Dr. Dale C. Ferguson
Space Environment Effects Branch
MS 302-1 NASA LeRC

SPACE ENVIRONMENT WIRING New LEO Requirements

- Atomic Oxygen Degradation Resistance
- Synergistic UV and AO Resistance
- Layout to Prevent Debris Strike Plasma Arc Flashovers
- Design to Prevent Plasma-Induced Pyrolysis
- AC Current Collection Issues

SPACE ENVIRONMENT WIRING Traditional Requirements

- Wide Range of Operational Temperatures
- High UV and Radiation Resistance
- Sufficient Dielectric Strength
- Low Outgassing of Condensibles
- Low Mass per Unit Length

SPACE ENVIRONMENT WIRING

Kapton Pyrolysis in Vacuo

- Noticed in 1982 in LeRC chamber
 - moving point of light, carbonized trail
 - pressure less than one-ten-thousandth Torr
 - at edge of Kapton in high field
- Accidentally occurred in 1989 SSF Solar Array Plasma Test
 - small hole in Kapton over biased copper
 - electron collection current large
 - pyrolysis at hole edge
- Tests and Modeling at LeRC (1990, 91)
 - pyrolysis by electron current reproduced in vacuo
 - temperature behavior modeled
 - important parameters noted

SPACE ENVIRONMENT WIRING

1982 LeRC Kapton Pyrolysis

- Argon Ion Beam in LeRC chamber
 - 1000 V potential on acceleration grid
 - Argon ions created by microwave discharge
 - Kapton insulator for accel grid
 - Pressure 1/10 milliTor
- Kapton Pyrolysis on Edge of 5 cm hole in Kapton
 - Pointlike, moving discharge
 - Continued for duration of voltage
 - Traversed entire circular edge
 - Entire edge charred, conductive
- Interesting Points
 - Required about 5 minutes before occurrence
 - No oxygen in chamber
 - Happened twice on different days

SPACE ENVIRONMENT WIRING

1989 SSF Kapton Pyrolysis

- Argon Plasma in Large LeRC chamber
 - +450 V potential on solar array panel
 - Argon plasma density 100,000 per cc
 - Small hole in Kapton over circuit trace
 - Pressure 1/100 milliTorr
- Kapton Pyrolysis on Edge of 1 cm hole in Kapton
 - No visual observation
 - Electron currents collected up by factor of 10
 - Charred Kapton-covered surface to edge of trace
 - Necessitated sample patching to continue tests
- Interesting Points
 - Happened after minutes in chamber
 - No oxygen in chamber
 - Metallization intact

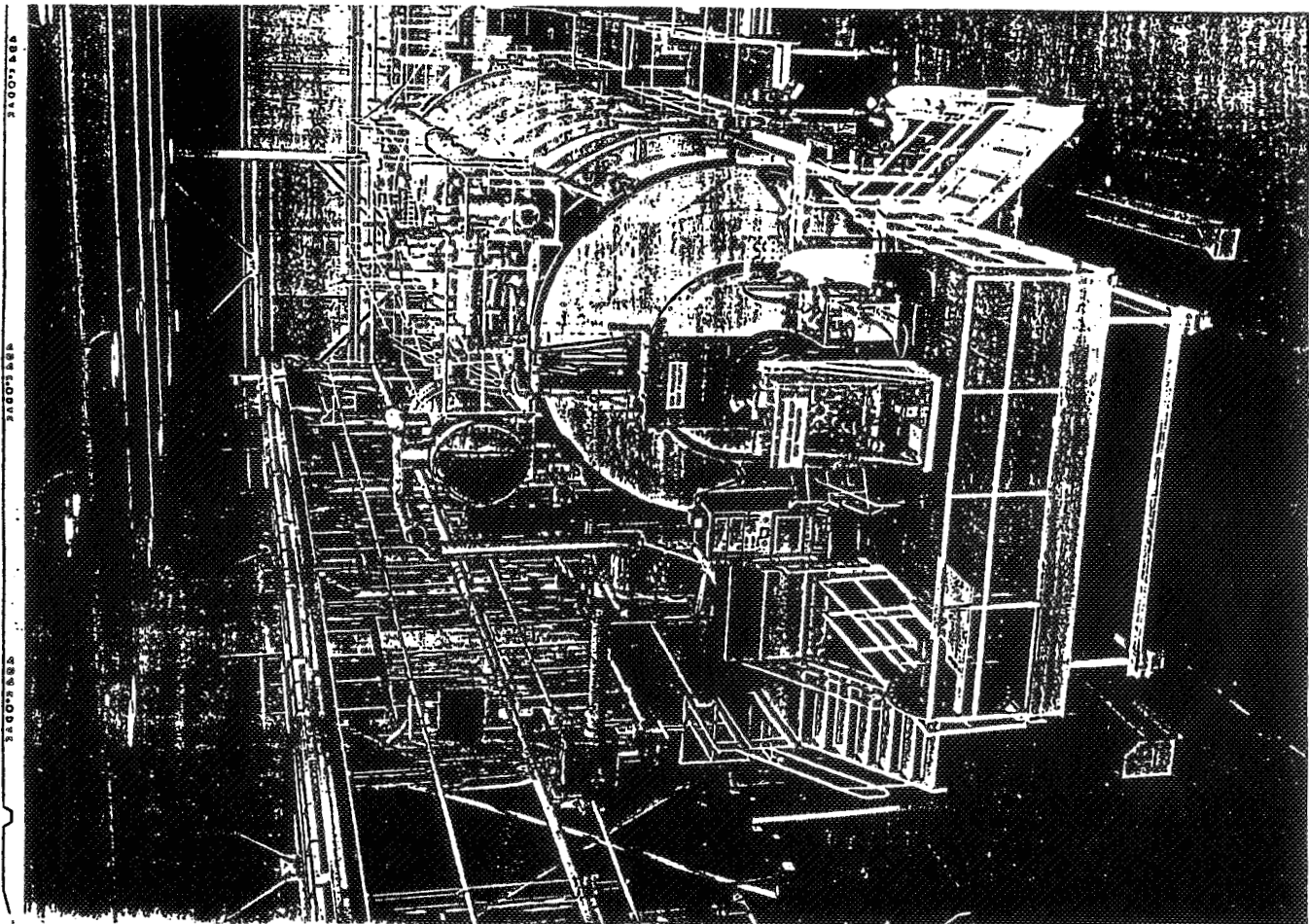

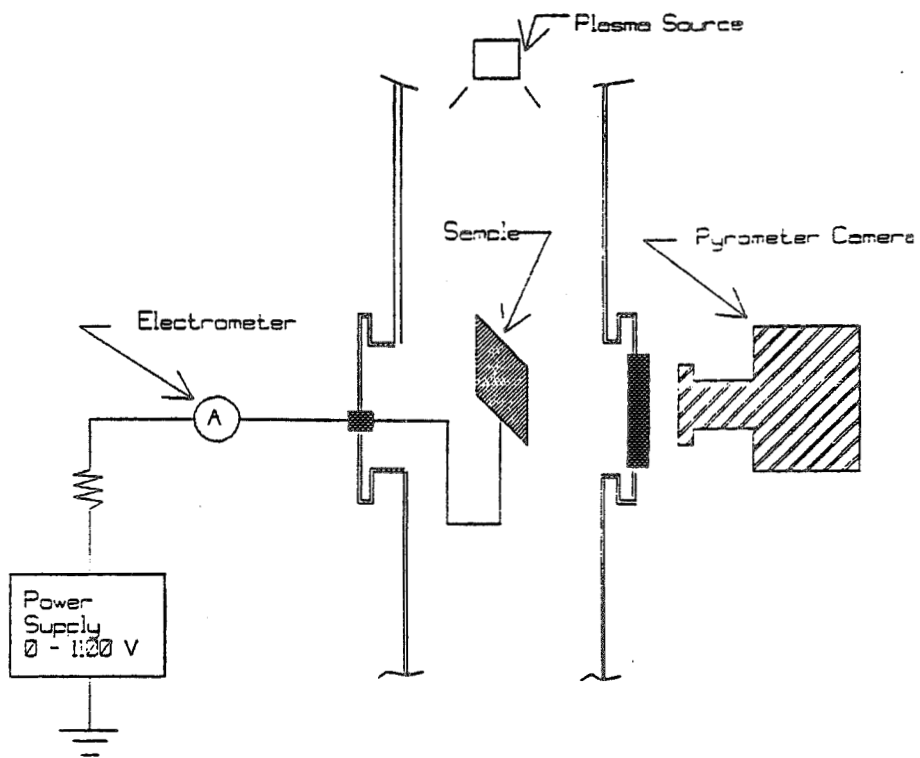
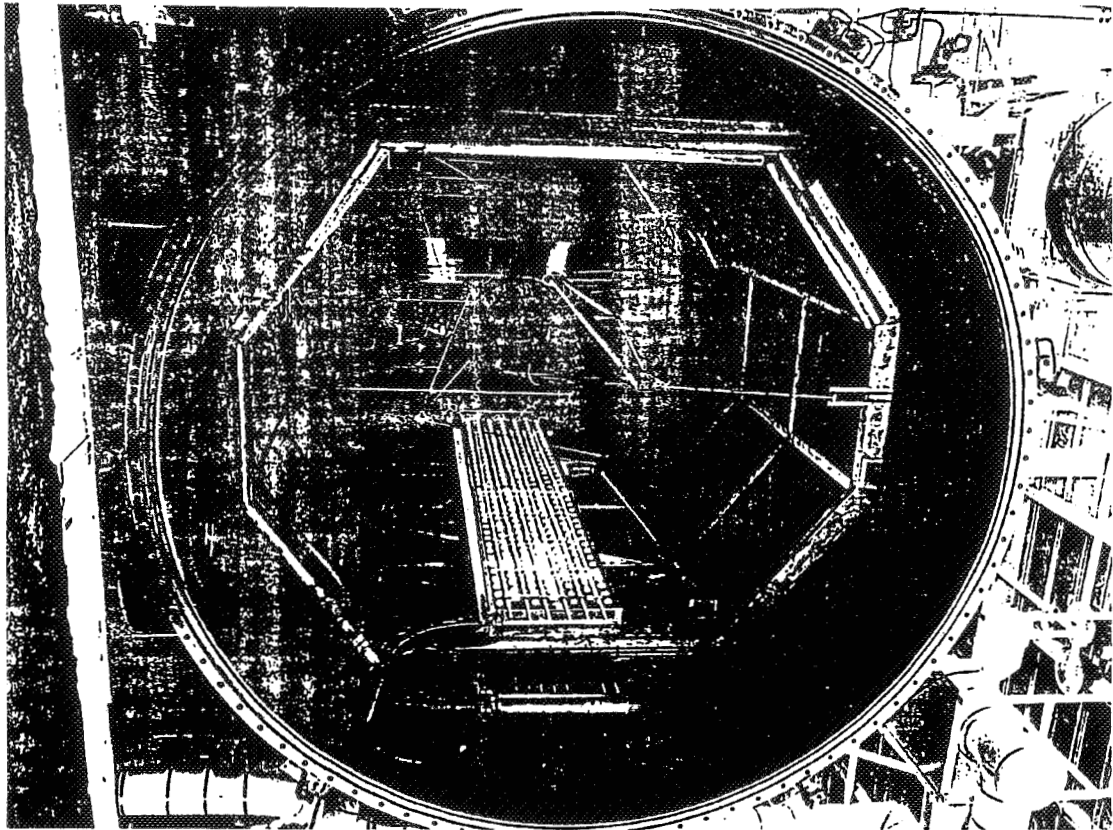

PYROLYZATION EXPERIMENT SETUP

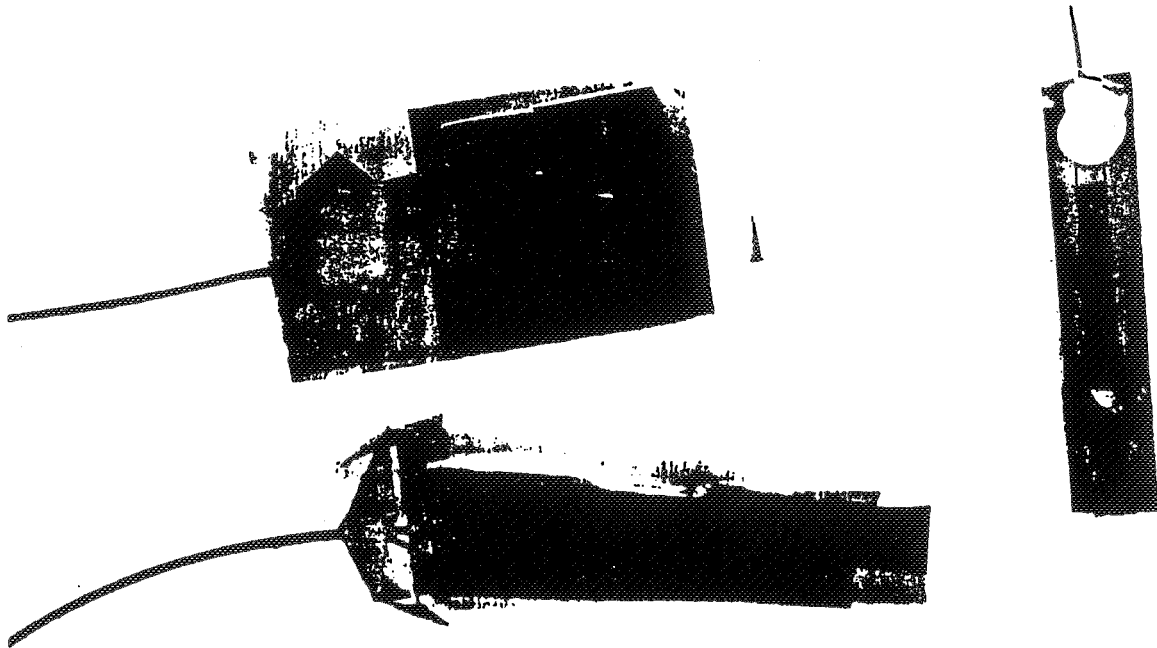
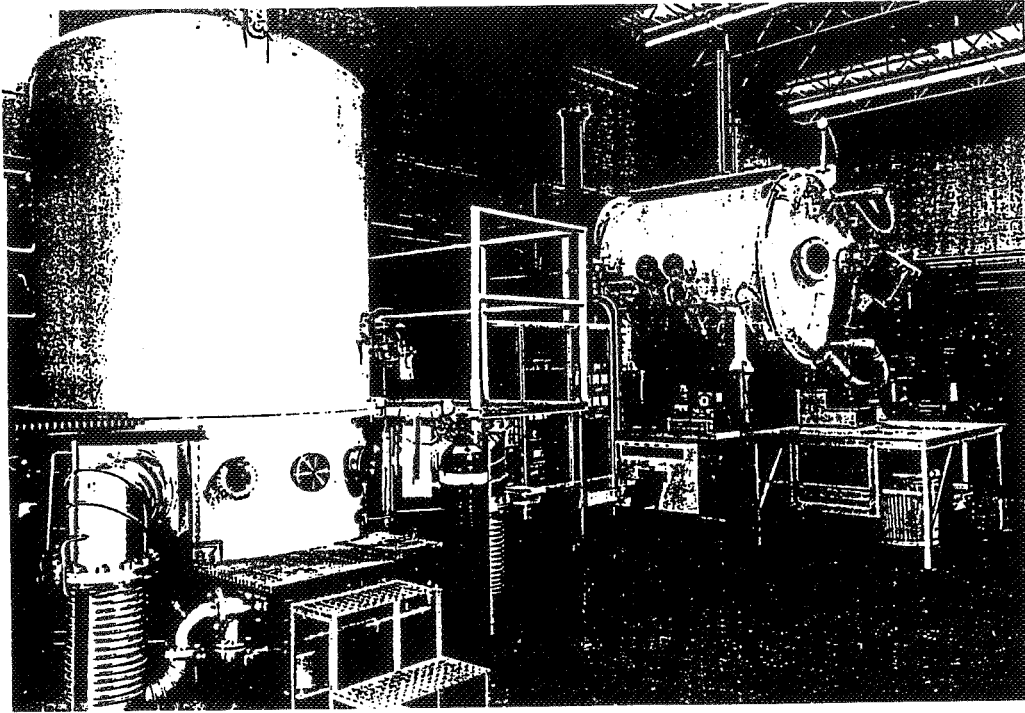

SPACE ENVIRONMENT WIRING

SEEB Modeling of Kapton Pyrolysis

- Kapton Pyrolysis Assumed to be Temperature Effect
 - Positive Bias for Electron Collection
 - Current times Voltage = Power into Heating Conductor
 - Conductor heats overlying Kapton
 - All sources and sinks accounted for
- Model Predicts Temperatures Observed in Tank Tests
 - Ohmic heating of current traces important
 - Trace thickness, width important to conduction
 - Kapton thickness, hole size important
 - Kapton adhesives, outgassing may be important
- Interesting Points
 - Pyrolysis occurs at 200-300 C, well below char temp
 - Hypothesized set of conditions for occurrence
 - May be designed around

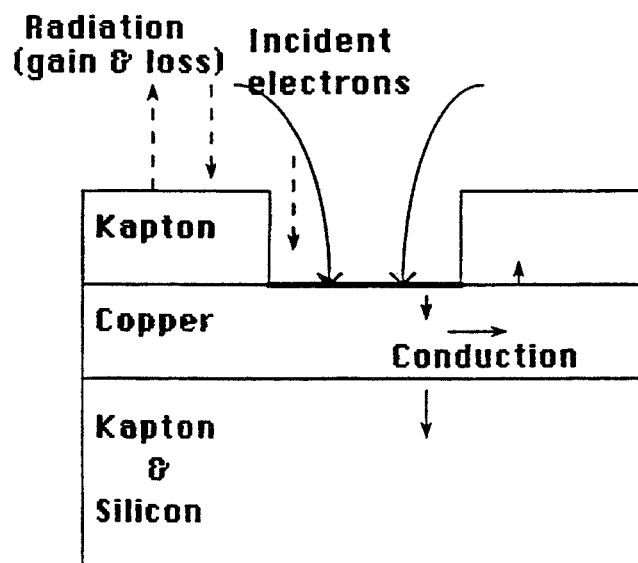

Sverdrup Technology

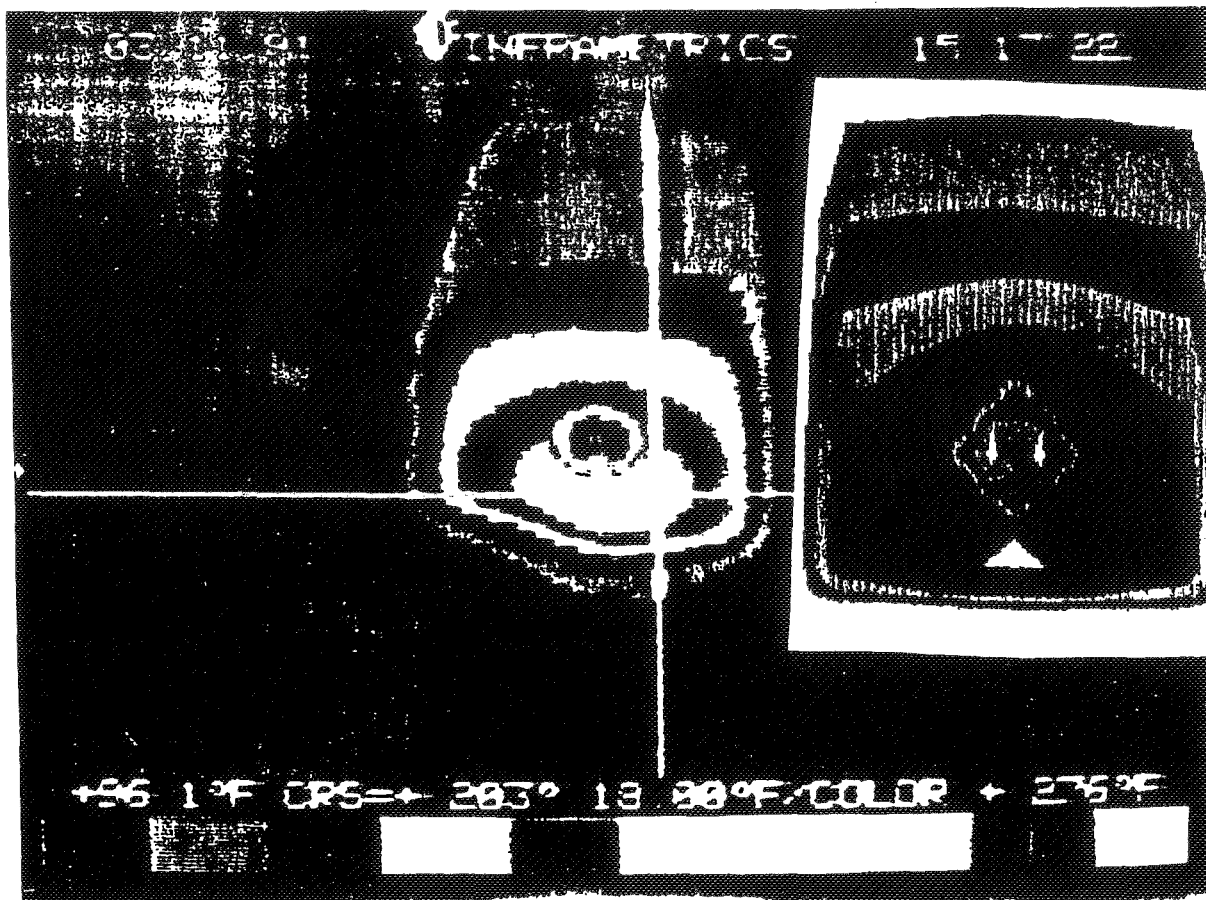

KAPTON PYROLYSIS

Hypothesized Conditions for Occurrence

- The current carrying trace is thin and covered all over with a poor heat conductor.
- The Kapton insulator covering the trace has a hole large enough to prevent current chokeoff (> 60 mil) but small enough to collect high snapover currents (< 1 inch?).
- The conductive trace is exposed to a high density LEO plasma in the ram direction.
- The trace is above $+ 100$ V with respect to the LEO plasma.
- All the above conditions hold for > 10 seconds.

omit

AEO BRIEFING TO WORKSHOP ON WIRING FOR SPACE APPLICATIONS

JOHN REAGAN
AEO - OMS&A
July 23, 1991

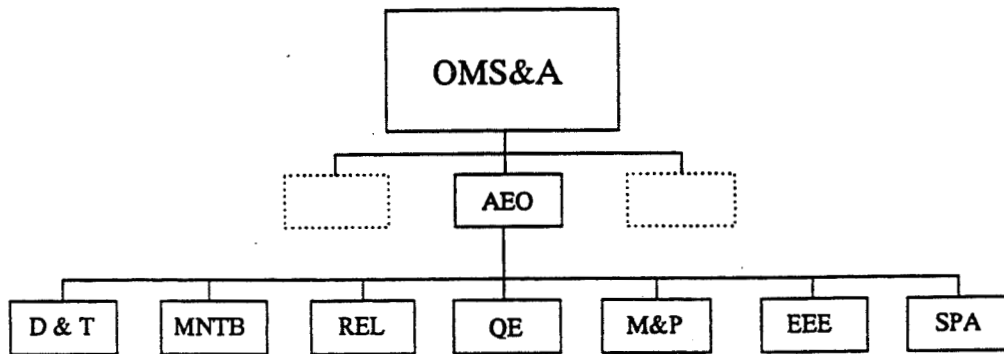

PRECEDING PAGE BLANK NOT FILMED

**PRESENT POSITION OF THE AEO
REGARDING THE USE OF KAPTON WIRE**

✎ KAPTON WIRE IS PRESENTLY A VIABLE MATERIAL
FOR USE IN FLIGHT HARDWARE

✎ CONSCIOUS ENGINEERING JUDGMENT MUST BE USED:

- MAINTENANCE
- ENVIRONMENT
- POWER CAPACITY

MUST BE CONSIDERED ON A CASE BY CASE BASIS

✎ WHERE PROPERLY ENGINEERED, INSTALLED, AND MAINTAINED
KAPTON WIRE PRESENTS LOW RISK

**PRESENT POSITION OF THE AEO
REGARDING THE USE OF KAPTON WIRE**

✎ WE STRONGLY SUPPORT RESEARCH AND DEVELOPMENT OF
ALTERNATIVE MATERIALS

✎ AS A PRACTICAL MATTER OUR SPACE EXPERIMENTS HAVE NOT
USED KAPTON WIRING - IT IS NOT LIKELY IN THE FUTURE -
BUT ITS USE IS NOT PRECLUDED

✎ SSF WILL EVALUATE ALL APPLICATIONS FOR PROPER USAGE

PERSONAL VIEW : THERE WILL BE KAPTON WIRE IN USE ON
SSF IN MANY AREAS

✎ ALL MATERIALS HAVE LIMITATIONS - THERE IS NO "PERFECT"
MATERIAL FOR ALL CONDITIONS

SESSION IV:

omit

CANDIDATE INSULATION MATERIALS AND CONSTRUCTIONS

30141
P- 6
109640
352971



**HIGH TEMPERATURE POLYMER
DIELECTRIC FILM-WIRE INSULATION**

**PRESENTED BY:
JOHN G. NAIRUS
WRIGHT LABORATORY
AERO PROPULSION AND POWER DIRECTORATE
24 JUL 91**

**HIGHLIGHTS OF PROGRAM
ACCOMPLISHMENTS**

- **TRW IDENTIFIED AND DEMONSTRATED THE POTENTIAL OF TWO AROMATIC/HETEROCYCLIC POLYMERS TO HAVE AN OUTSTANDING AND SUPERIOR COMBINATION OF ELECTRICAL, THERMAL, AND CHEMICAL RESISTANCE PROPERTIES VERSUS STATE-OF-THE-ART KAPTON[®] FOR SPACECRAFT AND/OR AIRCRAFT DIELECTRIC INSULATION APPLICATIONS (DATA PROVIDED IN TABLES THAT FOLLOW)**

- **FEASIBILITY WAS DEMONSTRATED FOR SUPPORTING/ENABLING TECHNOLOGIES SUCH AS CERAMIC COATINGS, CONTINUOUS FILM CASTING, AND CONDUCTOR WIRE WRAPPING, WHICH ARE DESIGNED TO ACCELERATE QUALIFICATION AND DEPLOYMENT OF THE NEW WIRE INSULATION MATERIALS FOR USAF SYSTEMS APPLICATIONS DURING THE MID- TO LATE-1990s**

PRECEDING PAGE BLANK NOT FILMED

HIGHLIGHT PRELIMINARY WIRE INSULATION RESULTS

- CANDIDATE 2 WAS SELECTED FOR SELECTED WIRE WRAPPING AND TESTING BASED UPON BEST BALANCE OF PROPERTIES
- 14-GAUGE BARE COPPER WIRE WAS SUCCESSFULLY DOUBLE LAYER TAPE WRAPPED WITH CANDIDATE 2 COATED WITH TEFLON FEP ADHESIVE (0.0005-INCH THICK, ONE SIDE) EMPLOYING A PROCESS SIMILAR TO INDUSTRY METHODOLOGY USED FOR KAPTON FN
- CANDIDATE 2 INSULATED WIRE DEMONSTRATED HIGHER STABILITY THAN KAPTON IN AIR AND BREAKDOWN VOLTAGE RETENTION AFTER AGING (192 HOURS):

INSULATION MATERIAL	AC BREAKDOWN VOLTAGE (KV)			INSULATION WEIGHT LOSS AT 300°C (%)
	BEFORE AGING	AFTER AGING	DECREASE (%)	
KAPTON	12.4	11.4	8	11
CANDIDATE 2	9.9	9.5	4	4

- THE TEFLON FEP ADHESIVE EMPLOYED FOR THE WIRE WRAPPING IS UNSUITABLE FOR LONG-TERM USE AT 300°C IN AIR (SIGNIFICANT LOSS OF POLYIMIDE TAPE ADHESION NOTED AFTER ~ 200 HOURS)
- DRY ARC/TRACK PERFORMANCE OF CANDIDATE 2 INSULATED WIRE MAY BE ASSESSED IN LATE-1991 AT ANOTHER PRIME CONTRACTOR (NOT AS PART OF THIS PROGRAM)

CONCLUSIONS

BASED UPON THE PROGRESS ACCOMPLISHED IN PERFORMANCE OF CONTRACT F33615-88-C-2909, THE FOLLOWING CONCLUSIONS ARE OFFERED:

- THE PROGRAM OBJECTIVE TO IDENTIFY AND DEMONSTRATE POLYMERIC DIELECTRIC FILMS POSSESSING A SUPERIOR COMBINATION OF ELECTRICAL, THERMAL, CHEMICAL AND PHYSICAL PROPERTIES TO THOSE POSSESSED BY KAPTON OVER THE TEMPERATURE RANGE OF -269°C TO +300°C HAS BEEN ACHIEVED. TWO POLYMERIC DIELECTRIC FILM MATERIAL CANDIDATES POSSESS THE FOLLOWING KEY SUPERIOR PROPERTIES TO KAPTON POLYIMIDE:
 - DIELECTRIC LOSS RESISTANCE AT 300°C,
 - OXIDATIVE AND VACUUM STABILITY AT 300°C,
 - HUMIDITY RESISTANCE AT 90°C/100% RH,
 - ULTRAVIOLET RADIATION RESISTANCE AT 25°C AND
 - BASIC SOLUTION (pH 10) HYDROLYSIS RESISTANCE AT 93°C,
- THE MORE MATURE DIELECTRIC FILM MATERIAL, CANDIDATE 2, POSSESSES HIGHER DRY ARC/TRACK RESISTANCE THAN KAPTON
- THE OVERALL PROPERTIES OF CANDIDATE 1 (IN THE DEVELOPMENTAL STATE IN FILM FORM) GENERALLY COMPARE VERY FAVORABLE WITH CANDIDATE 2 (AN OPTIMIZED FILM PRODUCT); OPTIMIZATION OF CANDIDATE 1 FILM MAY LEAD TO SUPERIOR FILM PROPERTIES TO CANDIDATE 2,
- CERAMIC COATINGS HAVE THE POTENTIAL TO SIGNIFICANTLY IMPROVE THE BREAKDOWN VOLTAGE AND/OR DRY ARC/TRACK RESISTANCE OF HIGH PERFORMANCE DIELECTRIC FILM MATERIALS
- CANDIDATE 2 FILM CAN BE CONVERTED INTO TAPE WRAPPED WIRE INSULATION BY THE SAME COMMERCIAL PROCESS CURRENTLY EMPLOYED TO PRODUCE KAPTON WIRE AND POSSESSES SUPERIOR 300°C OXIDATIVE STABILITY VERSUS KAPTON; HOWEVER, AN IMPROVED FILM WRAP TAPE ADHESIVE OVER TEFLON[®] FEP MUST BE IDENTIFIED AND DEVELOPED TO ACHIEVE THE TRUE POTENTIAL OF THE NEW WIRE INSULATION CANDIDATES FOR EXTENDED SERVICE AT 300°C.

PROGRAM OVERVIEW

- PROGRAM TITLE: HIGH TEMPERATURE POLYMER DIELECTRIC FILM
- CONTRACT NUMBER: F33615-88-C-2909
- CONTRACT VALUE: \$298K
- TECHNICAL PERIOD OF PERFORMANCE: THIRTY MONTHS (NOVEMBER, 1988 THROUGH MAY, 1991)
- TECHNICAL TASKS

<u>TASK</u>	<u>TITLE</u>	<u>STATUS</u>
1	SCREENING AND TEST PLAN DOCUMENTATION	COMPLETED
2	DEVELOPMENT AND DETAILED TESTING	COMPLETED
3	PRODUCT OPTIMIZATION	COMPLETED
4	WIRE INSULATION AND TESTING	COMPLETED
-	REPORTING	FINAL DRAFT SUBMITTED

- AERO PROPULSION AND POWER DIRECTORATE PROGRAM MANAGER: JOHN G. NAIRUS
- TRW PROGRAM MANAGER: ROBERT J. JONES

KEY PROGRAM PARTICIPANTS

<u>ORGANIZATION</u>	<u>KEY ROLE</u>	<u>TASK PARTICIPATION</u>
TRW	PRIME CONTRACTOR PERFORMED ALL EXPERIMENTAL WORK EXCEPT THAT CONDUCTED BY VENDORS (SEE BELOW)	ALL (1 THROUGH 4)
LAWRENCE TECHNOLOGY DIVISION OF CAMCO (FORMERLY TRW OILWELL CABLE DIVISION)	FILM ELECTRICAL PROPERTY TESTS, WIRE WRAPPING AND INSULATED WIRE TESTING	ALL (1 THROUGH 4)
WYLE LABORATORIES	CRYOGENIC IMMERSION TESTS	1
REXHAM CORPORATION	CONTINUOUS FILM CASTING	3
SHELD AHL CORPORATION	PRODUCED CERAMIC PROTECTIVE COATING ON FILMS	3

PROBLEM

STATE-OF-THE-ART HIGH PERFORMANCE, AROMATIC/HETEROCYCLIC DIELECTRIC FILM INSULATION MATERIALS (EXEMPLIFIED BY KAPTON) CURRENTLY SUFFER SEVERAL CRITICAL DEFICIENCIES:

- SIGNIFICANT DIELECTRIC LOSS AS A FUNCTION OF TEMPERATURE FROM APPROXIMATELY -80°C TO $+100^{\circ}\text{C}$ AND ABOVE APPROXIMATELY $+200^{\circ}\text{C}$,
- SIGNIFICANT DEGRADATION IN AIR (300°C AND ABOVE), HUMIDITY (95% RH) AND ULTRAVIOLET RADIATION (RT AND ABOVE)
- POOR RESISTANCE TO ARCING/TRACKING FAILURE.

OBJECTIVE

IDENTIFY AND EVALUATE COMMERCIALY AVAILABLE ADVANCED AROMATIC/HETEROCYCLIC FILM FORMING POLYMERS HAVING IMPROVED ELECTRICAL, THERMAL, HUMIDITY/CHEMICAL RESISTANCE PROPERTIES OVER KAPTON^R FOR WIRE INSULATION APPLICATIONS IN FUTURE SPACECRAFT. IDEALLY, THE NEW INSULATION MATERIAL WILL BE EQUALLY SUPERIOR FOR AIRCRAFT POWER GENERATION APPLICATIONS. THE GOAL PERFORMANCE TEMPERATURE RANGE IS FROM -260°C TO $\geq +300^{\circ}\text{C}$.

APPROACH

SELECT FIVE PROMISING CANDIDATES (BASED UPON AVAILABLE DATA) FROM HIGH TEMPERATURE RESISTANT, COMMERCIALY AVAILABLE, FILM FORMING POLYMERIC MATERIALS; CONDUCT KEY ELECTRICAL, THERMAL AND CHEMICAL PROPERTY TESTS EMPLOYING KAPTON^R AS THE CONTROL FILM MATERIAL; CONDUCT TEST PROGRAM ACCORDING TO THE FOLLOWING SEQUENTIAL TASK

<u>TASK</u>	<u>KEY TESTS</u>	<u>OUTPUT OF TASK</u>
1	SCREEN FIVE CANDIDATES FOR: <ul style="list-style-type: none">• HIGH TEMPERATURE PROPERTIES• LOW TEMPERATURE FLEXIBILITY• INITIAL ELECTRICAL PROPERTIES• INITIAL CLEANING SOLVENT STABILITY• OXIDATION RESISTANCE	DOWN SELECT TO THREE PROMISING CANDIDATES; DOCUMENT TEST PLAN FOR CONDUCTING REMAINDER OF PROGRAM
2	PERFORM DETAILED TESTS ON THREE CANDIDATES FOR: <ul style="list-style-type: none">• VACUUM RESISTANCE• HUMIDITY RESISTANCE• ULTRAVIOLET RESISTANCE• BASIC AND POLAR FLUID RESISTANCE	DOWNSELECT TO TWO MOST PROMISING CANDIDATES
3	PERFORM PROCESS OPTIMIZATION AND TEST ON TWO CANDIDATES IN TERMS OF: <ul style="list-style-type: none">• CERAMIC COATINGS• CONTINUOUS CASTING OF FILM	DOWNSELECT TO BEST CANDIDATE
4	WRAP FILM ON WIRE AND TEST FOR: <ul style="list-style-type: none">• ELECTRICAL PROPERTIES BEFORE AND AFTER AIR AND HUMIDITY AGING	WIRE TEST DATA/SAMPLES

HIGHLIGHT FILM DATA SUMMARY (TWO MOST PROMISING CANDIDATES VERSUS KAPTON CONTROL)

PROPERTY TYPE ASSESSED	SPECIFIC PROPERTY TEST	GOAL PROPERTY VALUES	PROPERTY TEST RESULTS		
			KAPTON	CANDIDATE 1	CANDIDATE 2
ELECTRICAL	DIELECTRIC CONSTANT (1000 HZ)				
	• RT	≥3.5	3.1	3.1	3.3
	• 300°C	≥3.2	2.8	2.9	3.3
	DISSIPATION FACTOR (1000 HZ)				
	• RT	≥0.003	0.001	0.001	0.002
	• 300°C	≥0.005	0.003	0.004	0.003
	BREAKDOWN VOLTAGE (RT, KV/MIL)				
	• AC UNCOATED	>5.0	7.7	6.1	6.1
	• AC CERAMIC COATED	>5.0	7.8	6.4	6.1
	• DC UNCOATED	>10.0	11.8	12.4	10.2
	• DC CERAMIC COATED	>10.0	12.7	12.9	10.2
	ARCTRACK - MEDIAN VALUES (SECONDS TO FAILURE)				
	• UNCOATED	>>180	181	129	192
	• CERAMIC COATED	>>180	183	141	215

HIGHLIGHT FILM DATA SUMMARY (TWO MOST PROMISING CANDIDATES VERSUS KAPTON CONTROL CONTINUED)

PROPERTY TYPE ASSESSED	SPECIFIC PROPERTY TEST	GOAL PROPERTY VALUES	KAPTON	CANDIDATE 1	CANDIDATE 2
THERMAL	MELT (OR DECOMPOSITION) TEMPERATURE (T_m °C)	>400°C	>400	>400	>400
	GLASS TRANSITION TEMPERATURE (APPARENT T_g °C)	>300°C	340	350	310
	CHAR YIELD IN VACUUM AT 800°C (%)	LESS THAN KAPTON	47	32	53
	LOW TEMPERATURE FLEXIBILITY (IMMERSION IN LIQUID HELIUM AT -269°C)	RESIST CRACKING (EQUIVALENT TO KAPTON)	NO EFFECT	NO EFFECT	NO EFFECT

HIGHLIGHT FILM DATA SUMMARY (TWO MOST PROMISING CANDIDATES VERSUS KAPTON CONTROL CONTINUED)

PROPERTY TYPE ASSESSED	SPECIFIC PROPERTY TEST	GOAL PROPERTY VALUES	KAPTON	CANDIDATE 1	CANDIDATE 2
ENVIRONMENTAL EXPOSURE	WEIGHT LOSS IN AIR AT 300°C FOR 1000 HOURS (%)	<5%	14	4	2
	WEIGHT LOSS IN HUMIDITY AT 90°C/100% RH FOR 1200 HOURS (%)	<1%	SAMPLES FAILED	0.4	0.0
	WEIGHT LOSS IN UV LIGHT (365 NMB) AT RT FOR 1000 HOURS (%)	LESS THAN KAPTON	6.7	1.4	0.5
	WEIGHT LOSS IN VACUUM (1 TORR) AT 300°C FOR 500 HOURS (%)	LESS THAN KAPTON	1.7	1.2	1.0
	WEIGHT LOSS IMMERSSED IN PH 10 BASIC SOLUTION AT 93°C FOR 96 HOURS (%)	LESS THAN KAPTON	2.6	1.3	1.2
	WEIGHT CHANGE IN METHYLETHYL KETONE AT 80°C FOR 500 HOURS (%)	<5% LOSS OR GAIN	+5.8	-2.9	-1.7



30140

P. 30

109641

352972

NEW INSULATION CONSTRUCTIONS FOR AEROSPACE WIRING APPLICATIONS

PROGRAM MANAGER: GEORGE SLENSKI
WL/MLSA
WPAFB OH 45433-6533

BACKGROUND:

- WIRING HAS BECOME AN IMPORTANT AIRCRAFT SYSTEM
 - HIGH COST DRIVER FOR ACQUISITION AND LOGISTICS
 - INCREASED RELIANCE ON AVIONICS
 - FLY-BY-WIRE SYSTEMS
- ISSUES RAISED CONCERNING THE PRIMARY INSULATION IN USE (KAPTON)
 - HANDLING CHARACTERISTICS
 - ENVIRONMENTAL AND FLUID COMPATIBILITY
 - SUSCEPTIBLE TO FLASHOVER
- ISSUES RAISED CONCERNING ALTERNATIVE INSULATIONS (X-LINKED TEFLON)
 - SUSCEPTIBLE TO CHAFING
 - THERMAL STABILITY
 - SMOKE GENERATION
 - CONDUCTOR CORROSION

AIR FORCE WIRING POLICY

- **81381 WILL NO LONGER BE THE WIRING OF FIRST CHOICE**
 - NEW SYSTEMS
 - MODIFICATIONS
 - REWIRING
- **NO ALTERNATE WIRING RECOMMENDED**
- **SELECT WIRING BASED ON SYSTEM REQUIREMENTS**
 - PERFORMANCE
 - MAINTENANCE

PROGRAM SUPPORT

- **PROGRAM COORDINATED AND PERIODICALLY REVIEWED WITH GOVERNMENT AND INDUSTRY**
 - AFSC, AFLC, ASD
 - NAVY-NAVAIR, NRL, NAC
 - FAA, NASA
 - SAE, NEMA
- **BROAD INDUSTRY PARTICIPATION**
 - FIVE AIRCRAFT COMPANIES
 - NINE WIRE MANUFACTURERS
 - THREE MATERIALS SUPPLIERS

New Insulation Constructions

Purpose

- Determine by Comprehensive Testing and Analysis if There Are New Insulation Constructions That Have Better Balance of Properties Than M22759/XL ETFE and M81381
- If New Insulation Constructions Are Identified That Possess Improved Balance of Properties, Identify Relative Costs, Processability Concerns, Material Availability, Multiple Sources and Environmental Impact to Manufacture

New Insulation Constructions

Program Contract Requirements

- Establish Performance Tests. Identify Weighting Factors for Each Test. Describe Minimum Performance Criteria
- Select 10 Candidate Insulations for Screening. Identify and Perform Screening Tests
- Select 4 Candidates from Screening Tests. Identify and Conduct Performance Tests
- Perform Assembly, Handling, Installation, Repair, and Chemical/ Thermal Tests on Best Candidate(s)
- Prepare and Provide Preliminary Specification(s) to Customer
- Prepare a Final Report on All Program Activities Including Recommendations to Customer for Replacement of Present Insulations
- Conduct Periodic Briefings
 - February 1989 - St. Louis
 - October 1990 - St. Louis
 - April 1991 - St. Louis

Test Plan

- Screening Tests (15)
 - 10 Candidates Plus M81381/7, /9, /11 and M22759/44, /33, /43
 - Testing by MCAIR
- Full Performance Tests (28)
 - 4 Selected Candidates Plus M81381 and M22759
 - Testing by MCAIR, DAC and DuPont
- Additional Testing
 - 270 Vdc Dry Arc Propagation Tests
 - Assembly, Handling and Repair Evaluations
 - Thermal and Chemical Stability Test by McDonnell Douglas Research Laboratory
 - Round Robin Tests

Wire and Cable Constructions Requested

Primary Wire

- 26 AWG* Thin Wall (5.8 mil)
- 22 AWG Thin Wall (5.8 mil)
- 22 AWG Thick Wall (8.6 mil)

Twisted Pair, Shielded and Jacketed

- 22 AWG Thin Wall
- 26 AWG* Thin Wall

Note: Not All Constructions Are Tested in Every Test

*26 AWG to Be CS95 Beryllium Copper Alloy

Construction Requirements

- Weight within M81381 Specs
- Diameter within M81381 Specs
- Silver Plated Conductor
- CS95 Alloy for 26 AWG Constructions
- Multiple Sources
- Production Quantity Capable

Insulation Candidates Provided for WRDC/MCAIR Test Program

	1st Layer	2nd Layer	3rd Layer/Topcoat
Barcel	2919 50% OL	Unsintered 0.002 in. PTFE Tape, Butt Wrap	
Brand Rex	XL ETFE 0.001 in. Tape, 50% OL	616 50% OL	XL ETFE 0.001 in. Tape, 50% OL
Champlain	2919 0.0035 in. Wall, 50% OL	Extr XL ETFE 0.0035 in. Wall	
DuPont	New Polyimide/ Fluoropolymer Tape, 0.0012 in. Thick, 50% OL	Same	Fluoropolymer
Filotex	PFTE Extrusion	616 0.0025 in. 53% OL Min	PFTE Topcoat 0.0008 in.

Insulation Candidates Provided for WRDC/MCAIR Test Program

	1st Layer	2nd Layer	3rd Layer/Topcoat
Gore	0.0015 in. PTFE Tape 0.003 in. Wall, 50% OL	0.0015 in. HSCR PTFE 0.003 in. Wall, 50% OL	
Tensolite	200AJ919, 0.0005 in. PTFE 0.001 in. H, 0.0005 in. PTFE 0.004 in. Wall, 50% OL	0.0015 in. PTFE Tape 0.003 in. Wall, 50% OL	
Thermatics	Mod PTFE Tape 0.0017 in. Thick, 50% OL	TPT Tape, (Mod PTFE, H, Mod PTFE), 0.00125 in. Thick, 50% OL	Mod PTFE Tape 0.0008 in. Thick 50% OL
NEMA #2	PTFE Tape 0.001 in. Thick, 0.0015 in. Wall	616 0.0024 in. Thick, 50% OL	PTFE Tape 0.001 in. Thick, 0.0018 in. Wall
NEMA #3	616 0.0024 in. Thick, 50% OL	Extr XL ETFE 0.004 in. Wall	

Performance Requirements

- Combat Damage
- Electrical
- Environmental
- General
- Marking
- Mechanical
- Thermal
- Weight and Dimensional

Weight Factor Per Individual Test

	Low	Moderate	High
• Probability of Occurrence	1	2	3
• Frequency of Occurrence	1	2	3
• Seriousness of Failure	1	3	5

- Add, then Divide by 2
- Max = 5.5
- Min = 1.5

Statistical Analysis

- Best Score = 0.0
- Deviation from 0.0 Is Determined by:

$$Z_n = (IX_b - X_n I) / S$$

Z_n = Numerical Score

X_b = Best Test Result

X_n = Candidate Test Result

S = Unbiased Standard Deviation

$$S = \sqrt{\frac{\sum(X_n - \bar{X})^2}{n-1}}$$

\bar{X} = Average Candidate Test Result

n = Number of Candidates

Screening Tests

Test	Document	Weight*
Finished Diameter	S - 901	4.2
Finished Weight	S - 902	4.2
Workmanship	S/M - 3.1.4	3.0
Stiffness and Springback	S - 708	4.2
Dry Arc Resistance	S - 301	5.5
Flammability	S - 801	4.3
Toxicity	B0482	5.0
Fluid Immersion	S - 601	4.5
Verification of Retained Properties: Heat Aged (1000 Hrs at 200°C)		
- Abrasion	S - 701	5.5
- Dynamic Cut Through	S - 703	4.5
- Flex Life	B0482	5.5
- Notch Propagation	S - 707	5.0
- Voltage Withstand	S - 510	5.5
- Insulation Resistance	S - 504	4.5
- Examine Product	S/M - 3.1.4	3.0

S - SAE AS4373

S/M - SAE AS4372 Proposed

B0482 - MCAIR Wire Test for MOD

* Avg = 4.6

Screening Test Results

	Overall WTD	Overall UNWTD	22 TN WTD	22 TK WTD	26 TN WTD	SJ Cable WTD
Filotex	1 6.52	1 6.15	1 6.25	2 6.90	4 8.23	No Test
Thermatics	2 7.23	2 7.16	4 9.11	1 6.68	1 7.16	6 8.45
NEMA #3	3 8.59	4 8.89	5 9.47	5 8.98	2 7.40	8 9.68
Gore	4 9.05	3 8.57	2 8.63	6 9.75	5 8.46	10 13.48
M81381/7/9/11	5 9.22	5 9.29	3 8.90	4 8.84	3 8.06	1 1.11
Tensolite	6 9.59	6 9.62	3 8.90	9 12.06	7 9.01	9 12.20
Champlain	7 9.92	8 9.82	8 10.78	7 10.51	8 9.06	3 4.34
Barcel	8 9.94	7 9.78	9 12.00	3 8.36	9 10.02	4 6.65
NEMA #2	9 10.97	10 11.21	7 10.71	8 10.83	11 12.75	11 16.57
M22759/44/33/43	10 11.18	9 10.89	6 9.78	11 13.16	10 12.34	5 8.24
Brand Rex	11 13.96	12 14.02	11 17.23	10 12.07	6 8.95	7 9.01
DuPont	12 14.19	11 13.66	10 15.01	12 16.69	12 14.40	2 4.31

SELECTED WIRE INSULATIONS FOR FULL PERFORMANCE EVALUATION

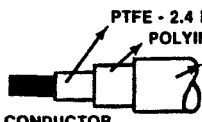
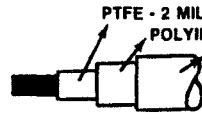
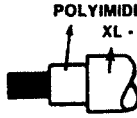
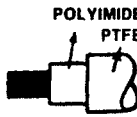
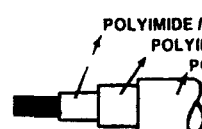
MATERIAL CONSTRUCTION (2.6 GA.)	WIRE DIAMETER (MILS)	WEIGHT / 1000 FT. (LBS)	PERCENTAGE POLYIMIDE / FLUOROPOLYMER
 <p>PTFE - 2.4 MIL POLYIMIDE / FEP (616) - 2.4 MIL PTFE TOPCOAT - 0.8 MIL</p> <p>CONDUCTOR</p> <p style="text-align: right;">FILOTEX</p>	29.6	1.27	36 / 64
 <p>PTFE - 2 MIL POLYIMIDE / PTFE - 2.4 MIL PTFE TAPE - 1.6 MIL</p> <p style="text-align: right;">THERMATICS</p>	29.7	1.33	33 / 67
 <p>POLYIMIDE / FEP - 2.4 MIL XL - ETFE - 4 MIL</p> <p style="text-align: right;">NEMA</p>	31.0	1.32	31 / 69
 <p>POLYIMIDE / PTFE - 4 MIL PTFE TAPE - 3 MIL</p> <p style="text-align: right;">TENSOLITE</p>	33.8	1.55	28 / 72
 <p>POLYIMIDE / FEP 2.4 MIL POLYIMIDE / FEP - 2.4 MIL POLYIMIDE TOPCOAT - 1 MIL</p> <p style="text-align: right;">MIL-W-81381/9</p>	34	1.30	69 / 31
<small>PTFE - POLYTETRAFLUOROETHYLENE FEP - FLUORINATED ETHYLENE PROPYLENE</small>		<small>XL - ETFE - CROSS - LINKED ETHYLENE - TETRAFLUORO ETHYLENE COPOLYMER NEMA - NATIONAL MANUFACTURER'S ELECTRICAL ASSOCIATION</small>	

Full Performance Tests

Test	Document	Weight*
Dielectric Constant	S - 501	2.0
Corona Inception and Extinction	S - 502	3.3
Surface Resistance	S - 506	2.2
Time/Current to Smoke	S - 507	3.3
Wet Arc Tracking	S - 509	3.2
Wire Fusing Time	S - 511	3.2
Forced Hydrolysis	S - 602	3.5
Humidity Resistance	S - 603	4.5
Weight Loss/Outgassing	S - 604	2.2
Weathering Resistance	S - 606	3.5
Wicking	S - 607	3.5
Abrasion	S - 701	5.2
Cold Bend	S - 702	3.3
Dynamic Cut Through	S - 703	4.8
Flex Life	S/M - 3.9.6	4.7

S - SAE AS4373, April 1989

S/M - SAE AS4372, Proposed

Full Performance Tests

Test	Document	Weight*
Insulation Impact Resistance	A - D256	3.1
Insulation Tensile Strength	S - 706	3.2
Notch Propagation	S - 707	5.0
Smoke Quantity	S - 803	4.3
Thermal Index	S - 804	4.0
Thermal Shock	S - 805	4.0
Wire Surface Markability	DMS 2325	3.8
Crush Resistance	A - D3032	3.0
Aging Stability - SJ Cable	M - 4.5.10	3.0
Jacket Wall Thickness - SJ Cable	F - 1018	3.3
Verification of Retained Properties	S - 805	5.5
Wire-to-Wire Rub	DAC Procedure	5.2
Dry Arc Prop - Large Guage, Thermal Age	BSI No. 43	5.5
270 VDC Dry Arc Prop - No Protection	S - 301	-
270 VDC Dry Arc Prop - w/Protection	CuDust	-
270 VDC Dry Arc Prop - Large Guage, Inorganic (NP)	CuDust	-

S - SAE AS4373, April 1989

A - ASTM

Avg = 3.8

M - MIL-C-27500G

F - Federal Standard 228

BSI - British Standards Institute

DAC - Douglas Aircraft Co.

DMS - Douglas Materials Specification

NP - No Protection

Overall Screening and Full Performance Test Results

	Overall WTD	Overall UNWTD	22 TN WTD	22 TK WTD	26 TN WTD	SJ Cable WTD
Filotex	1 8.22	2 8.42	2 8.50	2 9.53	2 9.13	* *
Tensolite	2 8.23	1 7.43	1 7.57	4 10.16	3 9.32	1 7.15
M81381/7/9/11	3 9.21	3 8.69	3 8.79	1 7.93	1 6.90	2 8.65
Thermatics	4 9.39	4 9.43	5 10.38	3 9.55	5 10.22	4 8.86
NEMA #3	5 10.48	5 9.92	4 10.02	5 11.20	4 9.35	5 9.93
M22759/44/33/43	6 11.38	6 10.73	6 11.59	6 12.48	6 12.42	3 8.81

* No SJ Cable Was Provided for Screening Tests

ABRASION TEST RESULTS ON THERMALLY AGED

22 AWG, 5.8 MIL WALL, HOOK UP WIRE

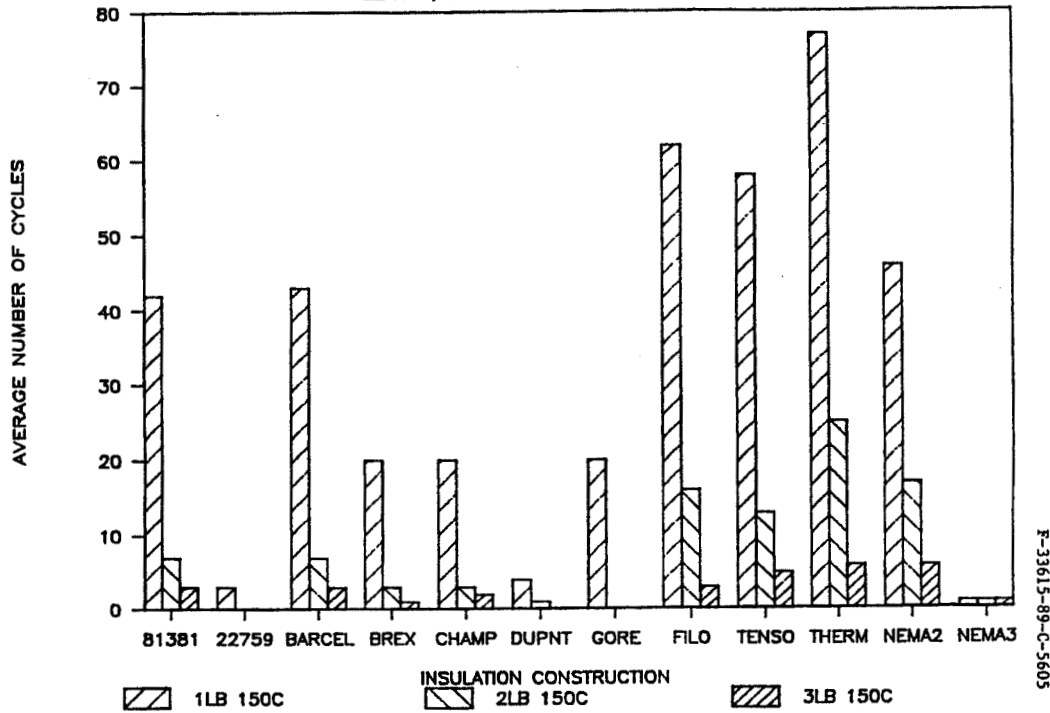

**FIGURE 3.17 - ABRASION TEST RESULTS ON THERMALLY AGED,
22AWG, 5.8 MIL WALL, HOOK UP WIRE AT 150°C**

BSI DRY ARC PROPAGATION TEST

HARNES DAMAGE TEST RESULTS

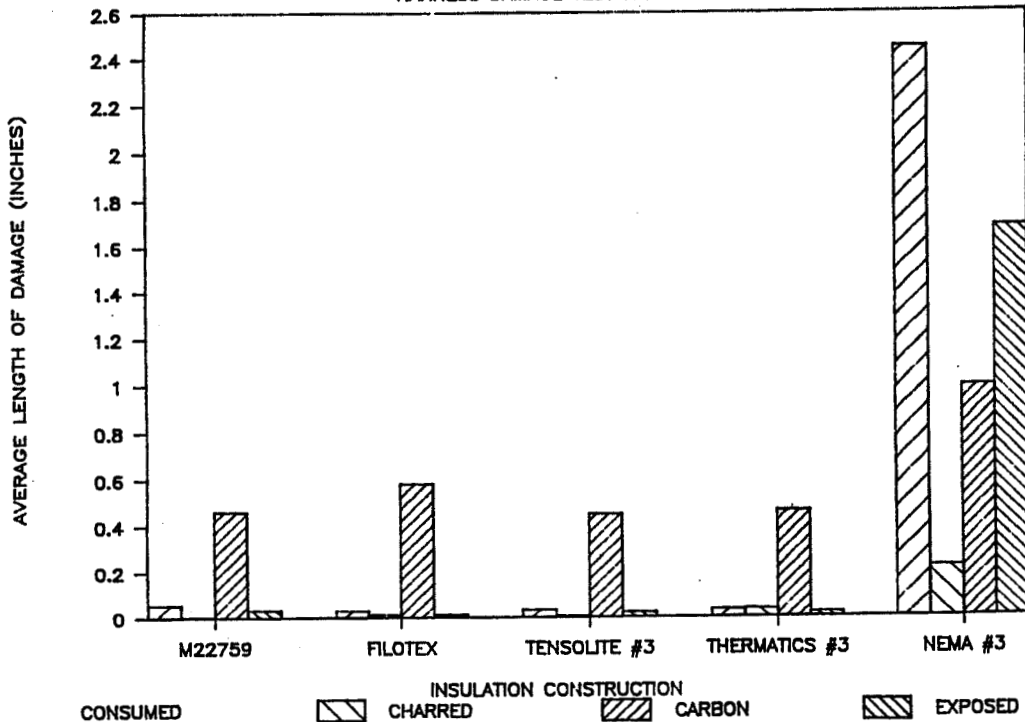

STIFFNESS TEST RESULTS

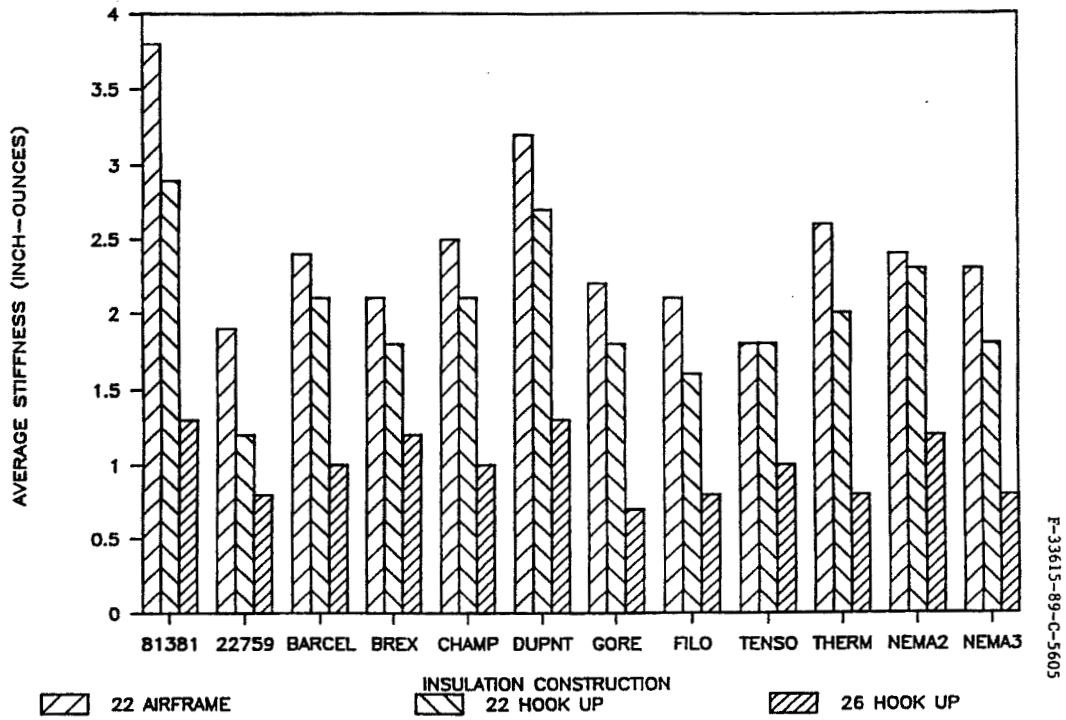

FIGURE 3.35 - STIFFNESS TEST RESULTS

F-33615-89-C-5605

WIRE TO WIRE RUB TEST RESULTS

M81381 SPECIMEN IN MOTION

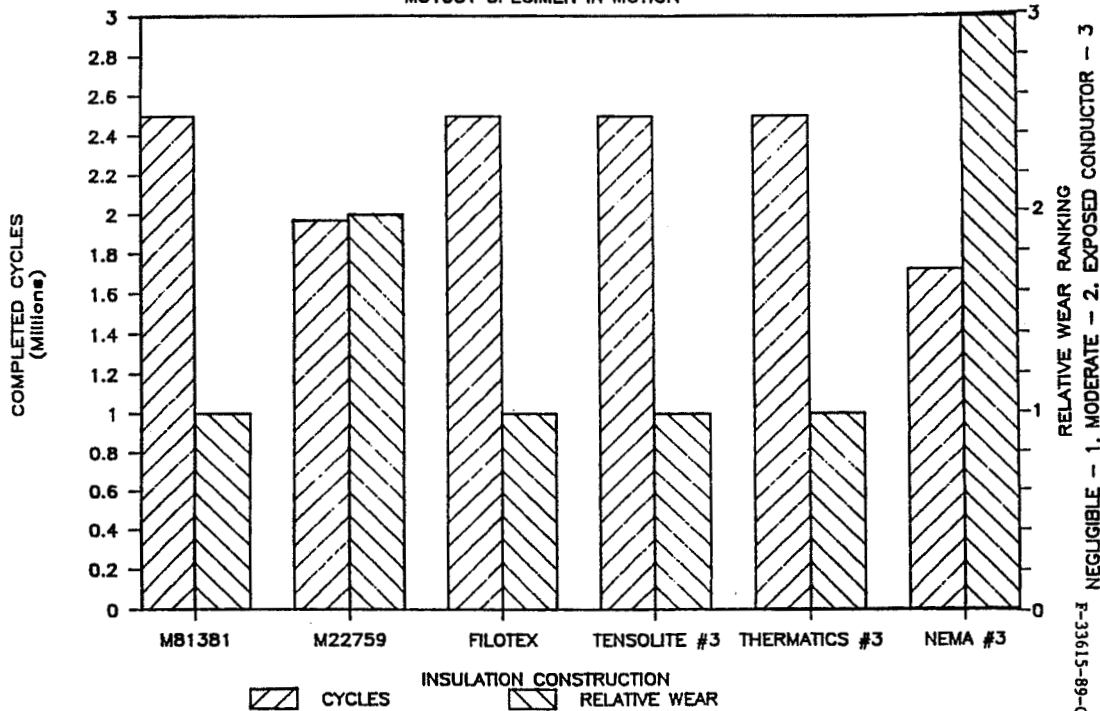
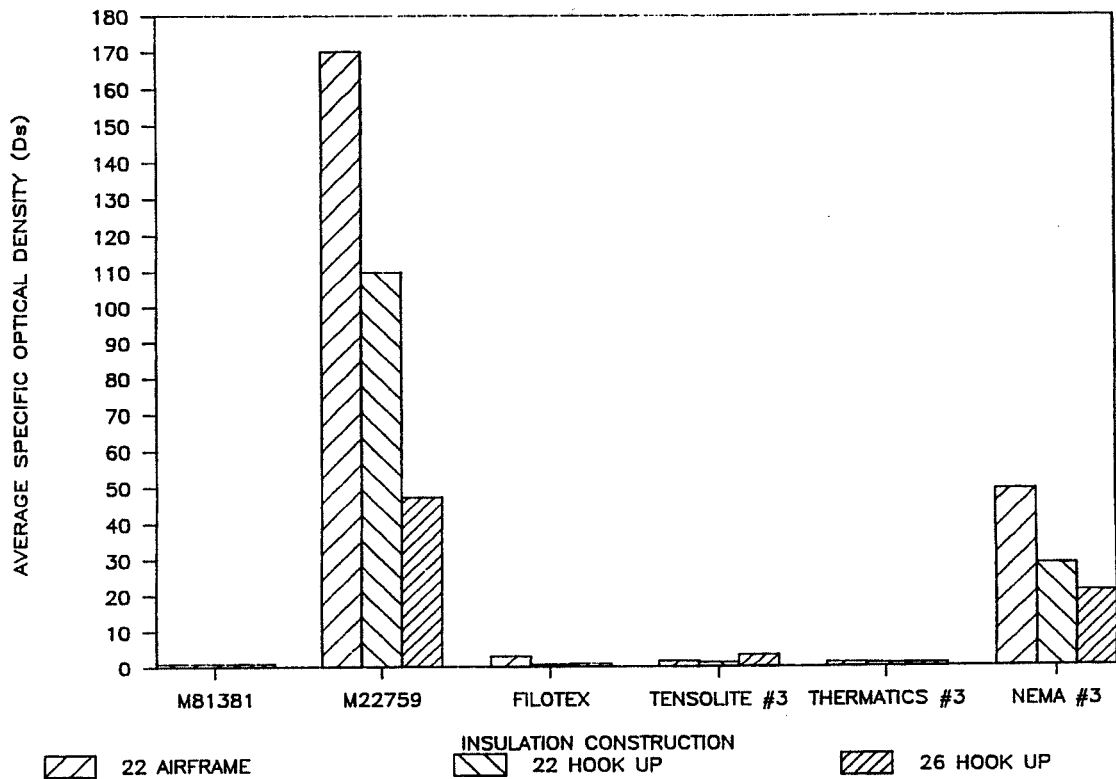

FIGURE 5.82 - WIRE TO WIRE RUB TEST RESULTS,
M81381 SPECIMEN IN MOTION

5095-C-68-5195-F-33615-89-C-5605
NEGLECTIBLE - 1, MODERATE - 2, EXPOSED CONDUCTOR - 3

SMOKE QUANTITY TEST RESULTS



E-331615-89-C-5605

FIGURE 5.91 - SMOKE QUANTITY TEST RESULTS

Assembly, Handling and Repair Specimens Tested

- M22759/33/44 22 Thin, 26 Thin
 22 SJ, 26 SJ

- Filotex 22 Thin, 26 Thin
 22 SJ, 26 SJ

- Tensolite 22 Thin, 26 Thin
 22 SJ, 26 SJ

Assembly, Handling and Repair Test Results

- **Filotex**
 - Best Performer
 - Most Flexible, Easiest to Handle
 - Difficulty During Shield Splice
- **Tensolite**
 - Wire Stiffness Aids in Connector Insertion and Harness Twisting
 - Some Tendency Toward Coiling in Layout

Candidate Performance Review Standing

1) Filotex, 2) Tensolite, 3) Thermatics, 4) NEMA 3

Rationale For Preferred Choice

- Filotex Used NPC on 100 Series Wire to Meet MCAIR Test Start Deadline
- Filotex Has Indicated the 200 Series Wire Using SPC Is Not Capable of Being Produced in Their Production Facility. Many Insulators are Uncomfortable with Production of 0.002" Extruded PTFE
- Tensolite Diameter and Weights Do Not Fall Within the M81381 Diameter and Weight Guidelines Established. Since USAF/MCAIR Are Discussing a Direct Replacement of M81381 in F-15's with the Preferred Construction, Tensolite's Diameter and Weight Would Create Problems

Diameter and Weight Specification Comparisons

	22 AWG, 8.6 mil		22 AWG, 5.8 mil		26 AWG, 5.8 mil	
Construction	Diameter Specification	Weight Specification	Diameter Specification	Weight Specification	Diameter Specification	Weight Specification
Tensolite	.047 - .049	3.2	.045 - .047	3.0	.035 - .037	1.6
M81381	.045 - .049	3.0	.041 - .044	2.8	.031 - .034	1.3
M22759	.050 ± .002	3.2	.043 ± .002	2.8	.032 ± .002	1.4

4 Draft Sheets Prepared

LWC Light Weight (Thin Wall) Copper
Similar to M22759/44

LWA Light Weight (Thin Wall) Alloy
Similar to M22759/33

NWC Normal Weight (Thick Wall) Copper
Similar to M22759/43

NWA Normal Weight (Thick Wall) Alloy
Similar to M22759/35

Cost Observations/Predictions

Estimates Ranged from
Comparable with M81381 Up to
a 25% Increase Over M81381

Conclusions

- Two Candidates Performed Better than Both Baseline Constructions, and the Other Two Performed Better than M22759
- Three Out of Four Candidates Demonstrated NO Arc Propagation Characteristics In Our Evaluations
- NEMA #3 and Thermatics Candidates Met All Program Requirements (ie: Multi Source, Weight and Dimensional Equivalent to M81381, and Production Capability)
- Filotex and Tensolite Are Excellent Performers if Program Requirements Allow Use of Nickel Plated Conductor (Filotex) or Larger Wire (Tensolite)

Cost Observations/Predictions

Estimates Ranged from
Comparable with M81381 Up to
a 25% Increase Over M81381

Military Specification Sheet

Wire, Electric, PTFE, Fluorocarbon/Polyimide,
PTFE Insulated, Lightweight, Silver Coated
Copper Conductor, 200°C, 600 Volts

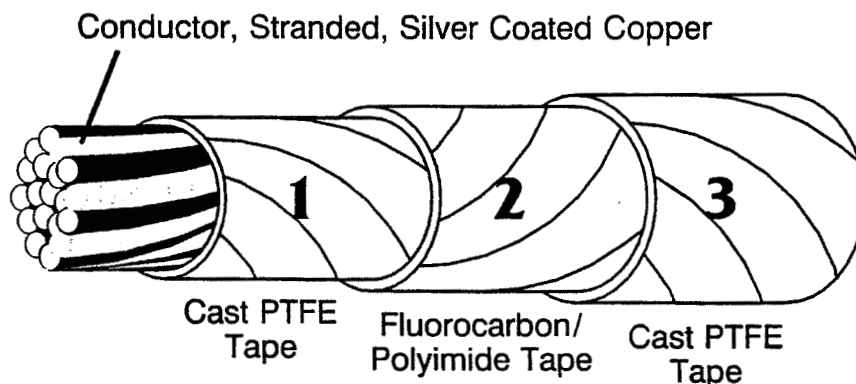

BENEFITS

- **PROVIDES THIN WALL AND LIGHT WEIGHT WIRE INSULATIONS FOR AEROSPACE USE**
 - **DIRECT REPLACEMENT FOR M81381 WIRING**
 - **MANUFACTURABLE BY MORE THAN ONE SOURCE**

- **INCREASED MAINTAINABILITY**
 - **IMPROVED FLEXIBILITY OVER M81381**
 - **LASER MARKABLE**

- **INCREASED RELIABILITY**
 - **FLASHOVER (ARC TRACKING) RESISTANT**
 - **IMPROVED ENVIRONMENTAL RESISTANCE OVER M81381**

- **IMPROVED PERFORMANCE**
 - **HIGHER TEMPERATURE CAPABILITY OVER M81381 AND M22759**
 - **IMPROVED MECHANICAL PROPERTIES OVER M22759**

TECHNOLOGY TRANSITION PLAN PROGRAM DELIVERABLES

- **PREPARE PRELIMINARY WIRE SPECIFICATIONS**
 - **AFLC/2750 AND NAVY WILL INCORPORATE AT LEAST TWO CONSTRUCTIONS INTO M22759**
 - **AT LEAST TWO MANUFACTURERS WILL BE QUALIFIED TO THE SPECIFICATIONS**

- **PROVIDE TEST DATA TO SUPPORT THREE NEW CONSTRUCTIONS**
 - **THERMATICS - PTFE/KAPTON/PTFE, AG PLATING**
 - **TENSOLITE - KAPTON/PTFE, AG PLATING**
 - **FILOTEX - PTFE/KAPTON/PTFE, NI PLATING**

TECHNOLOGY TRANSITION PLAN FOLLOW-ON ACTIVITIES

- MONITOR PROGRAMS USING NEW INSULATIONS
 - TENSOLITE-TYPE WIRING CHOSEN BY BOEING FOR NEW PRODUCTION AIRCRAFT
 - THERMATICS-TYPE WIRING CHOSEN FOR THE EUROPEAN FIGHTER AIRCRAFT
- FLIGHT TEST NEW WIRING CONSTRUCTIONS

Amendment #1 **270 Vdc Dry Arc Resistance/ Fault Propagation**

Measure the Resistance of the Insulation to Arc Propagation as a Result of a 270 Vdc Power System Short

- Method 301 of SAE AS4373 as a Guide. Backplates and One Harness Clamp Were Grounded. No Insulation Resistance Test and *No Circuit Protection*
- 20 Wires Per Harness of a 43 ± 1 Inch Length (22 and 26 Gauge, Thin Wall)
- 270 Vdc, 30 kW, Westinghouse Generator

Amendment #1 Results

All of the Tested Insulation
Constructions Exhibited Some Degree
of Arc Propagation in Unprotected
270 Vdc Circuits

Amendment #1 Conclusions

Insulation Is Not a Viable Means of Inhibiting an Arc at 270 Vdc; Other Circuit Protection Devices Must Be Examined

Amendment #2

270 Vdc Dry Arc Propagation

Repeat the 270 Vdc Dry Arc Propagation Tests with Power Controllers Protecting the Harness

- 48 ± 1 Inch Harness of 22 AWG Thin Wall Wire (Tested with Four Low Amperage Power Controllers)
- 48 ± 1 Inch Harness of 12 AWG Thick Wall Wire (Tested with Two High Amperage Power Controllers)
- 48 ± 1 Inch Harness of Inorganic Insulation (with No Circuit Protection)
- 7 Wire Harness
- Copper Dust Shorting Method

Amendment #2

270 Vdc Dry Arc Propagation Test Power Controller Suppliers

Supplier	Rated Amperage	Harness Gauge
Eaton Corporation	40A	12 AWG
Hartman	40A	12 AWG
ILC Data Device Corp	15A	22 AWG
Kilovac	15A	22 AWG
Teledyne Solid State	5A	22 AWG
Texas Instruments	10A	22 AWG

AMENDMENT #2 RESULTS

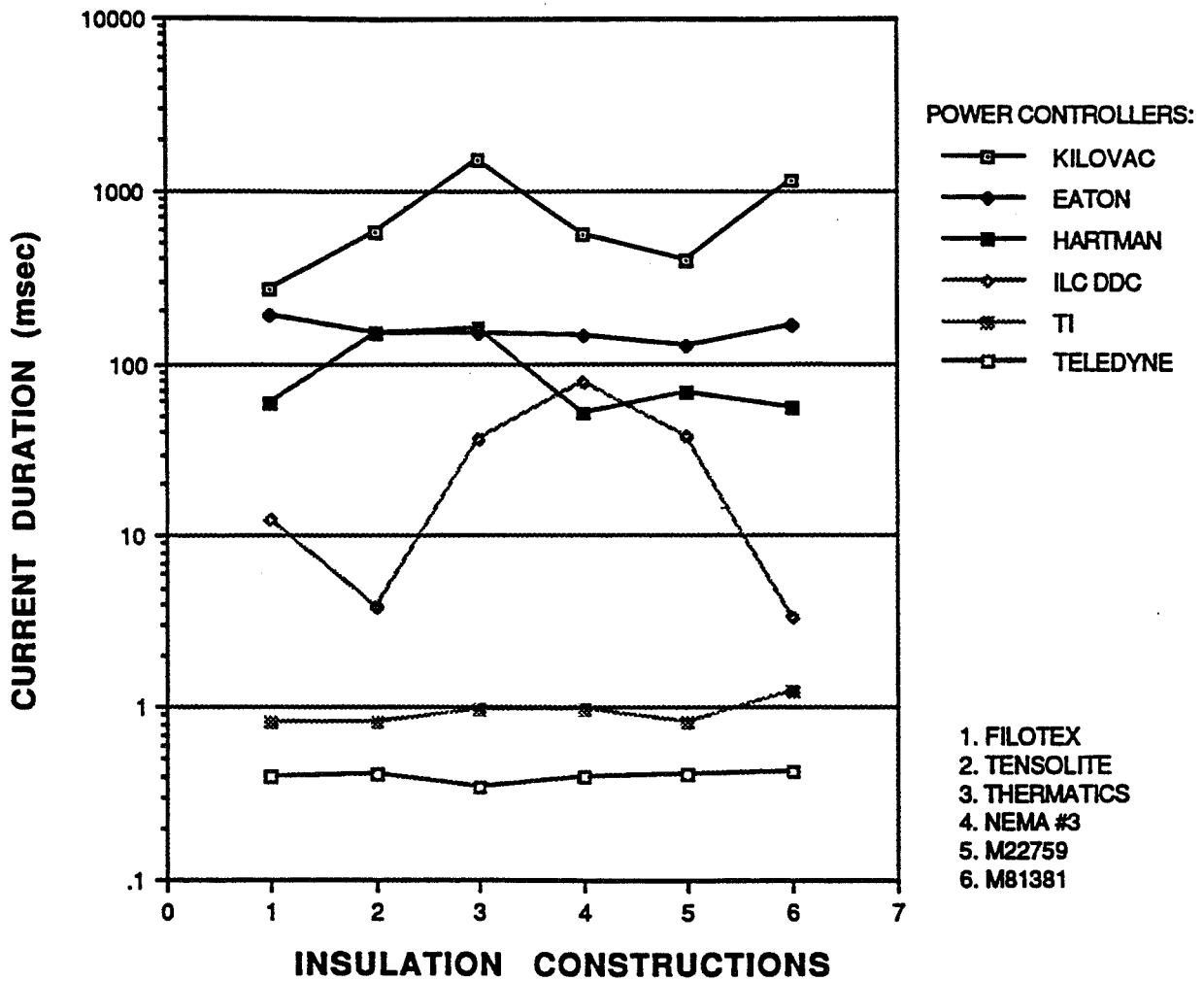

Amendment #2 Conclusions

Circuit Protection Devices Are Required to Protect 270 Vdc Interconnect Systems from Arc Propagation. There Are Protection Devices Available which Sufficiently Limit Arc Propagation

AEROSPACE WIRE AND CABLE

Presentation for NASA
Lewis Research Center
July 24, 1991

by
E. I. du Pont de Nemours & Co., Inc.
Dr. David H. Berkebile

AEROSPACE WIRE & CABLE SUPPLIERS

- DuPont is a Supplier of Materials
(DuPont is not a wire vendor or processor)
- Wire Processors (such as Teledyne Thermatics)
manufacture and sell Wire and Cable.
- Distributors (such as A.E.Petsche) also are
vendors of aerospace wiring.
- DuPont sells Teflon[®], Tefzel[®], Kapton[®], Nomex[®],
Kevlar[®], Dacron[®], & Liquid H. Nearly all
of the polymer systems that are used in
aerospace wiring systems.

DU PONT WIRE & CABLE

DU PONT POLYMERS

Alcryn® Melt Processible Rubber
Elvaloy® Resin Modifiers
Elvax® Resins
Hypalon® Synthetic Rubber
Hytrel® Polyester Elastomer
Kapton® Polyimide Film
Kevlar® Aramid Fiber
Mylar® Polyester Film
Neoprene Synthetic Rubber
Nomex® Aramid Fiber
Nordel® Hydrocarbon Rubber
Polyethylene Resins
Surlyn® Ionomer Resins
Teflon® Fluorocarbon Resins (FEP, PFA, TFE)
Tefzel® Fluoropolymer Resins
Vamac® Ethylene Acrylic Elastomer
Zytel® Nylon Resin

AEROSPACE WIRE & CABLE SELECTION

- Many excellent aerospace wire constructions are available.
- Appropriate engineering selections depend upon understanding the actual end use requirements and their relative importance.
- Using a single performance criteria a wire could be designed for almost any demand. (bullet-proof, very flexible, very small, light weight, arc propagation resistance, high abrasion resistance, excellent fuel resistance, etc., etc., etc.)
- However, you can't have it all at once !!

→ → → → → Increased toughness → → → → →

PTFE ETFE XL-ETFE POLYIMIDE

← ← ← ← ← Increased flexibility ← ← ← ← ←

There is no perfect insulation

COMPARISON OF CHOICES

<u>MAJOR CONCERNS</u>	<u>RELATIVE RANKING</u>			
	1	2	3	4
ARC PROPAGATION RES.(AC)	TEF	TFZ	XTZ	KAP
FLEXIBILITY	TEF	TFZ	XTZ	KAP
WEATHERABILITY (UV,H ₂ O,O ₂)	TEF	TFZ	XTZ	KAP
CHEMICAL INERTNESS	TEF	TFZ	XTZ	KAP
HYDROLYSIS RESISTANCE	TEF	TFZ	XTZ	KAP
NOTCH SENSITIVITY	TEF	TFZ	KAP	XTZ
THERMAL LIFE	TEF	KAP	XTZ	TFZ
FLAMMABILITY	TEF	KAP	TFZ	XTZ
LOW SMOKE	KAP	TEF	TFZ	XTZ
COLD FLOW (CREEP @ TEMP)	KAP	XTZ	TEF	TFZ
ABRASION/CUT-THRU	KAP	XTZ	TFZ	TEF
WEIGHT	KAP	XTZ	TFZ	TEF
SPACE	KAP	XTZ	TFZ	TEF

<u>CODES</u>	<u>TYPICAL MIL SPECS</u>
TEF = TEFLON® PTFE	----- 22759/12
KAP = KAPTON®	----- 81381/7
TFZ = TEFZEL®	----- 22759/17
XTZ = CROSSLINKED TEFZEL®	----- 22759/34

NEW HYBRIDS CHOICES

<u>MAJOR CONCERNS</u>	<u>RELATIVE RANKING</u>			
	1	2	3	4
ARC PROPAGATION RES.(AC)	TEF	TFZ	■ XTZ	KAP
FLEXIBILITY	TEF	TFZ	■ XTZ	KAP
WEATHERABILITY (UV,H ₂ O,O ₂)	TEF	■ TFZ	XTZ	KAP
CHEMICAL INERTNESS	TEF	TFZ	■ XTZ	KAP
HYDROLYSIS RESISTANCE	TEF	TFZ	■ XTZ	KAP
NOTCH SENSITIVITY	TEF	TFZ	■ KAP	XTZ
THERMAL LIFE	TEF	■ KAP	XTZ	TFZ
FLAMMABILITY	TEF	■ KAP	TFZ	XTZ
LOW SMOKE	KAP	■ TEF	TFZ	XTZ
COLD FLOW (CREEP @ TEMP)	KAP	■ XTZ	TEF	TFZ
ABRASION/CUT-THRU	KAP	■ XTZ	TFZ	TEF
WEIGHT	KAP	■ XTZ	TFZ	TEF
SPACE	KAP	■ XTZ	TFZ	TEF

■ = HYBRIDS OF TEFLON TFE & KAPTON (T/K/Ts)

<u>CODES</u>	<u>TYPICAL MIL SPECS</u>
TEF = TEFLON® PTFE	----- 22759/12
KAP = KAPTON®	----- 81381/7
TFZ = TEFZEL®	----- 22759/17
XTZ = CROSSLINKED TEFZEL®	----- 22759/34

DESIGN CONSIDERATIONS

- Weight and size requirements
- Human exposure vs equipment only
- Internal vs external
- Low earth orbit vs deep space
- Signal vs Power
- Exposed vs protected & not exposed
- AC vs DC power

DUPONT WOULD LIKE THE OPPORTUNITY
TO ASSIST IN THE APPROPRIATE USE
OF MATERIALS IN WIRING SYSTEMS
FOR SPACE APPLICATIONS

David Berkebile (302) 999-3623

Mike McCord (302) 996-8546

OMT

WIRE AND CABLE DESIGN
FOR SPACE APPLICATIONS -
NEW IDEAS

Bruce Pike
Teledyne Thermatics

PHYSICAL CONSIDERATIONS

- . Temperature Characteristics
- . Flexibility
- . Strength and Toughness
- . Size and Shape
- . Flame Response

FLAT CABLE CHARACTERISTICS

- . Planar Flexibility
- . Size and Shape
- . Cables and Conductors

PRECEDING PAGE BLANK NOT FILMED

ELECTRICAL CONSIDERATIONS

- . Signal versus power applications
- . Data Transmission
- . EMI

CONDUCTORS

- . Conductivity versus Strength
- . Downsizing

	<u>CONDUCTIVITY</u> <u>(% IACS)</u>	<u>BREAK STRENGTH</u> <u>(KPSI)</u>
Copper	100	35
Aluminum	62	10
PD 135	88	58
Stainless Steel	20	60
CS 95	62	95

FLAT CABLE CONSTRUCTIONS

- . Lamination
- . Woven
- . Extrusion

SEVERE TEMPERATURE APPLICATIONS

- . Fire Zone
- . Circuit Integrity
- . Thermocouple

DATA CABLES

- . Token Ring 150 Ohm
- . Data Buss 70 Ohm
- . FDDI

EMI

- . Reciprocity Theorem

EMI FIXES

- . Low Noise
- . Filter Line
- . Flat Shields
- . Foil and Braid

COMPOSITE INSULATION SYSTEMS

- . Weight and Size
- . Tailored to Application
- . Proven

352473
N95- 16057

30149
P-810P
109642

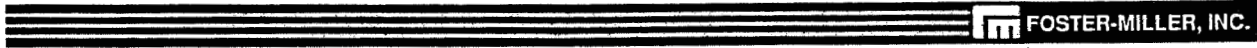

HIGH PERFORMANCE DIELECTRIC MATERIALS DEVELOPMENT

by

J. Piché, Ted Kirchner and K. Jayaraj

Foster-Miller, Inc.
350 Second Avenue
Waltham, Massachusetts 02154-1196

FOSTER-MILLER, INC.

- **37 year old independent technology development company**
- **Located in the Boston area**
- **About 270 employees**
- **Primary areas of business**
 - **Advanced polymers** - **Robotics**
 - **Composites** - **Special machinery**

POLYMER COMPOSITES MATERIALS TECHNOLOGY

- **Mission**
 - Develop materials and processing technology to meet DoD and commercial needs
- **Specific Areas of Research**
 - High temperature dielectric materials
 - High performance dielectrics for capacitors
 - Electronics packaging
 - High performance structural materials
 - Micro-composite blends
 - NLO materials, devices
 - Smart processing

HIGH PERFORMANCE CAPACITORS

- **300°C Filter capacitor for aircraft power conditioning**
 - Funded by the U.S. Air Force
- **8 kJ/kg Repetition rated energy storage capacitor - SDIO**
- **High energy density dielectric film - U.S. Army**
- **Interpenetrated polymer network capacitor - SDIO (Scheduled to start September, 1991)**

HIGH TEMPERATURE AEROSPACE INSULATION

- Identify and develop new insulation materials that can operate reliably at 250°C+
- Phase I SBIR program started in July, 1991
- Funded by the U.S. Air Force
- Monitored by Mr. George Slenski, and Mr. Eddie White

TARGET FOR NEW INSULATION

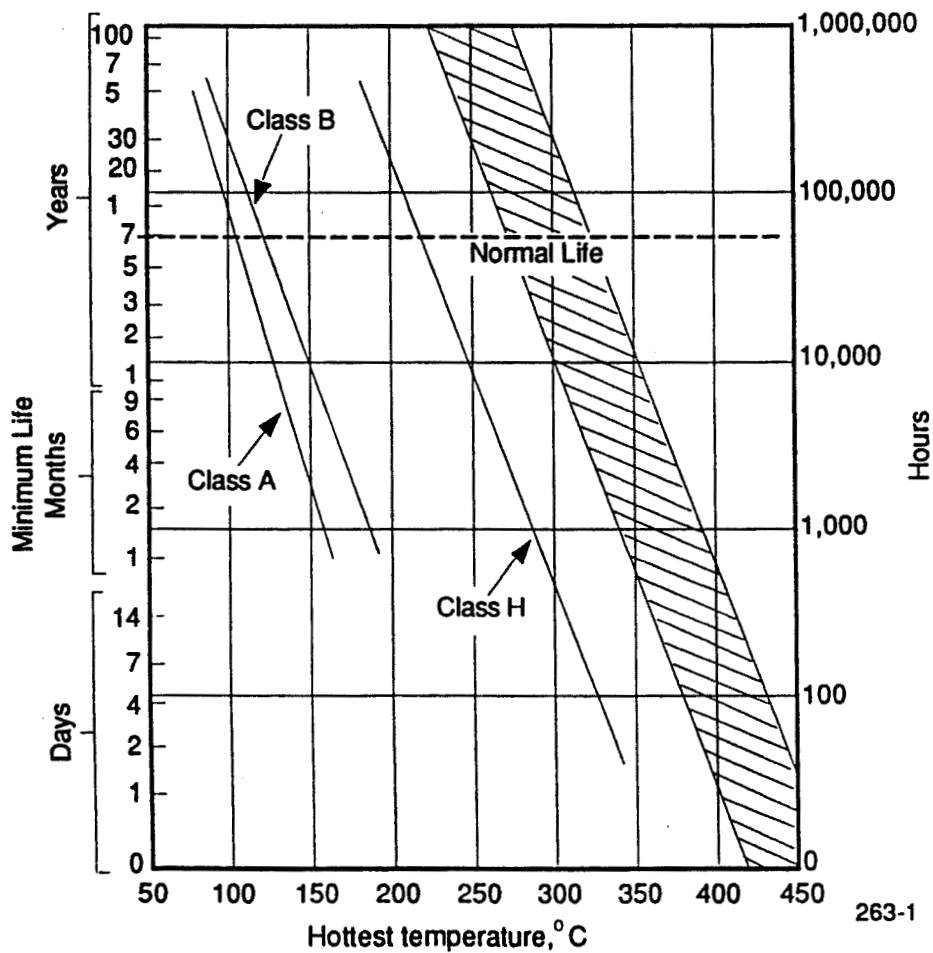

WHY FOSTER-MILLER?

- **Extensive experience in the development of advanced materials for specific DoD applications**
 - Thermotropic LCPs, Xydar, Vectra for PWBs
 - Lyotropic LCPs, e.g. PBZT, PBO for capacitors, light weight structures
 - High performance polyimides - electronic packaging
 - Blends of Vectra and LARC TPI
 - Blends of Matramid and PES
 - Interpenetrating networks of PBO, PBZT and polyimide resins, epoxies
- **Foster-Miller is not a material vendor**
- **Design and synthesize novel materials**
- **Develop techniques to process difficult materials into films for major material producers**
- **Close working relationship with**
 - Resin vendors
 - Cable and wire vendors
 - System houses
 - Airframe companies
 - and leading experts
- **Related experience in**
 - High temperature dielectrics for capacitors
 - Insulation for electromagnetic launchers

APPROACH

- **Phase I**
 - **Identify key performance parameters and requirements for high temperature insulation materials**
 - **Prepare an evaluation matrix consisting of appropriate weighted coefficients for each performance parameter**
 - **Characterize each candidate material with a composite relative merit index (performance index) using the evaluation matrix**
 - **Select a small number of candidates that meet or exceed all requirements for further investigation**

- **Phase II**
 - **Thoroughly characterize selected materials**
 - **Develop methods to fabricate round and flat wire constructions**
 - **Evaluate materials in finished wire constructions**
 - **Pick one for incorporation into an airframe**

PHASE I PROGRAM PLAN

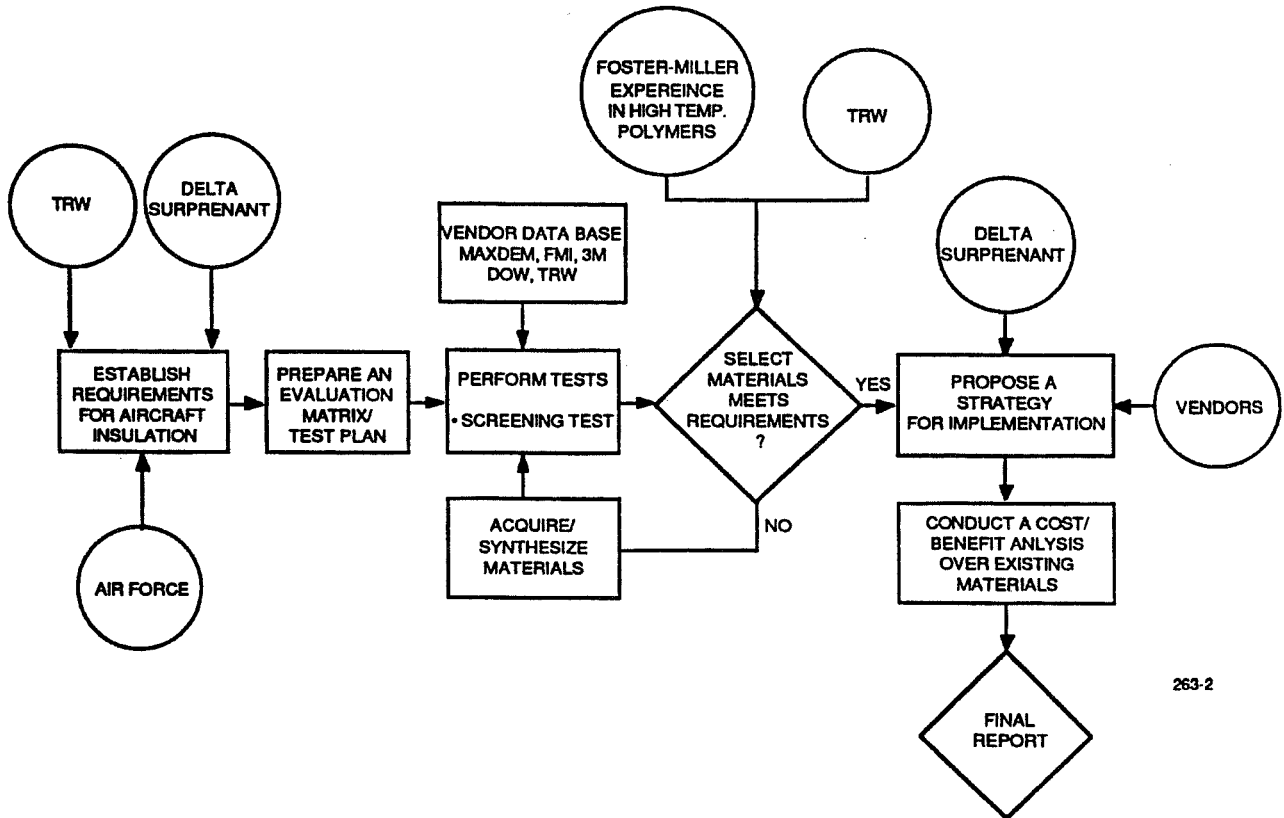

263-2

REQUIREMENTS/EVALUATION PARAMETERS

- 250°C+ temperature rating
 - Thermal index
- Dry arc resistance
- Voltage withstand, insulation resistance, flammability
- Toxicity, smoke quantity, . . .
- Retention of properties
 - Abrasion, flex life . . .

MATERIALS UNDER CONSIDERATION

Material	Source	Advantages and Properties
Fluorinated PBO-PI	Hoechst Celanese	Combines processibility of polyimides with high temperature properties of LCPs
Thermoplastic PBO with hexafluorinated moieties	Material Lab, WRDC	Thermally processible, high temperature stability, $T_g > 380^\circ\text{C}$
Difluoro-PBZT, tetrafluoro-PBZT	Foster-Miller	High temperature stability, low dielectric constant
PQ-100 polyquinolines	Maxdem	Thermally processible, available in a number of configurations, high purity
PBO-fluorinated IPN	Foster-Miller	High temperature stability combined with resistance to flashover
PBO	Foster-Miller, Dow	Ultra high thermal stability $300 - 350^\circ\text{C}$ significantly exceeds the performance of Kapton and Tefzel
FPE proprietary aromatic polyester	3M	Readily available high quality aromatic films useful up to 250°C
Fluorinated polyimides	Hoescht-Celanese Ube/ICI DuPont	Readily available, from Ube/ICI, DuPont thermal stability exceeds Kapton and Tefzel
Polysiloxaneimides	McGrath, VPI	Resistant to ionizing radiation, high thermal stability
Fluorocarbon-hydrocarbon polymers	Tefzel, DuPont	Readily available, high quality films, moderate thermal stability
Organo-ceramic hybrid nano composites	Garth Wilkes, VPI	Resistant to ionizing radiation, high thermal stability, greater than 200°C
Polysilsequioxane	David Sarnoff Labs	Good electrical properties up to 250°C superior to Kapton and Tefzel, can dip or spray coat

ADVANCED INSULATION MUST MEET MINIMUM PERFORMANCE INCREASES OVER CURRENT MATERIALS AND BE AMENABLE TO LARGE-SCALE PROCESSING AT ACCEPTABLE COSTS

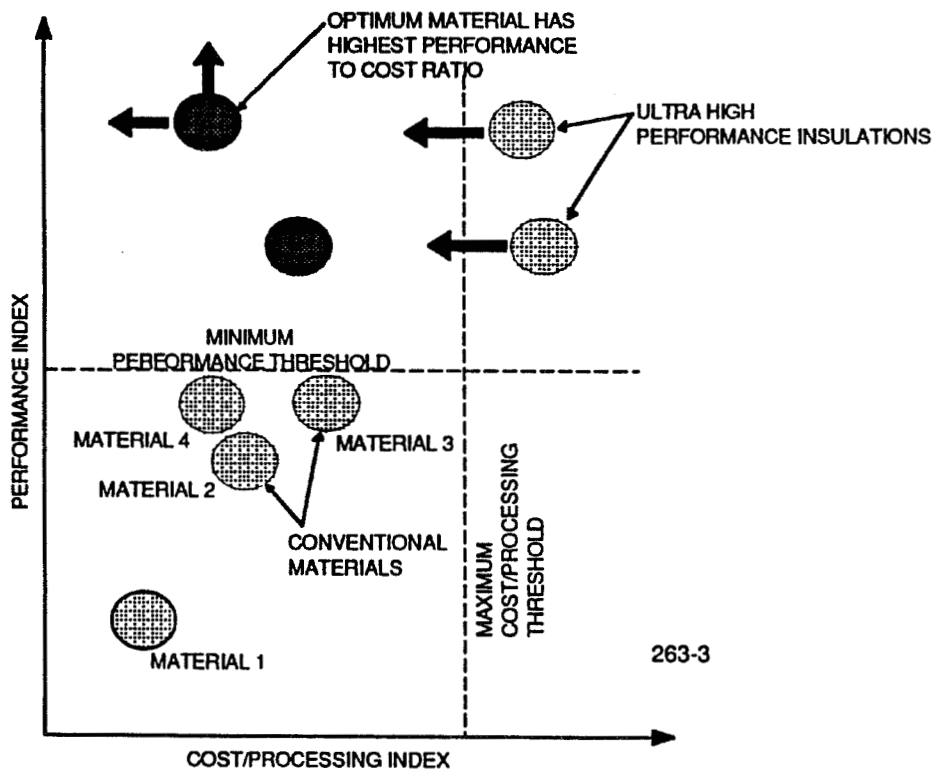

LIST OF ATTENDEES

Bruce Banks
NASA Lewis Research Center
MS 302-1
21000 Brookpark Road
Cleveland, OH 44135

Eric Baumann
NASA Lewis Research Center
MS 301-2
21000 Brookpark Road
Cleveland, OH 44135

Jon Bayliss
NASA Kennedy Space Center
MS DMMSL-23
Kennedy Space Center, FL 32899

Bob G. Beaman
NASA Goddard Space Flight Center
Mail Code 421.0
Greenbelt, MD 20771

Robert W. Bercaw
NASA Lewis Research Center
MS 301-2
21000 Brookpark Road
Cleveland, OH 44135

David Berkebile
E.I. Dupont Co.
Specialty Polymers Division
Chestnut Run Plaza, Bldg. 713
Wilmington, DE 19898

Henry W. Brandhorst, Jr.
NASA Lewis Research Center
MS 301-3
21000 Brookpark Road
Cleveland, OH 44135

John Burke
NASA Johnson Space Center
Mail Code EP5
Houston, TX 77058

Frank Campbell
Naval Research Laboratory
Code 4654
Washington, DC 20375

Bob Detwiler
Jet Propulsion Laboratory
MS 198-2
4800 Oak Grove Drive
Pasadena, CA 91109

John E. Dickman
NASA Lewis Research Center
MS 301-2
21000 Brookpark Rd.
Cleveland, OH 44135

Patrick Dillon
Jet Propulsion Laboratory
MS 1-106
4800 Oak Grove Drive
Pasadena, CA 91109

Walter Dinkins
Lawrence Technology
2400 Packer Rd.
Lawrence, KS 66044

Stan Domitz
NASA Lewis Research Center
MS 301-2
21000 Brookpark Rd.
Cleveland, OH 44135

Edgar H. Fay
Sverdrup Technology, Inc.
LeRC Group
2001 Aerospace Parkway
Brook Park, OH 44142

Dale C. Ferguson
NASA Lewis Research Center
MS 302-1
21000 Brookpark Rd.
Cleveland, OH 44135

Wilson F. Ford
NASA Lewis Research Center
MS 501-4
21000 Brookpark Rd.
Cleveland, OH 44135

Robert Friedman
NASA Lewis Research Center
MS 500-217
21000 Brookpark Rd.
Cleveland, OH 44135

Sandra Fries-Carr
WPAFB
WL/POOC
Wright Patterson AFB, OH 45433

Krista Gaustad
Auburn University
231 Leach Center
Auburn, AL 36849

Ahmad Hammoud
Sverdrup Technology, Inc.
MS 301-2
21000 Brookpark Rd.
Cleveland, OH 44135

John E. Harbison
NASA Marshall Space Flight Center
MS EP 64
Huntsville, AL 35812

Robert Hendrix
NASA Johnson Space Center
Mail Code EP54
Houston, TX 77058

Bob Jones
TRW, Inc.
One Space Park
Bldg. 01 R2040
Redondo Beach, CA 90278

Dennis J. Kacmar
Allied-Apical
P.O. Box 2332
Morristown, NJ 07962-2332

Wassim Khachen
University of Buffalo
312 W. Bonner Hall
Buffalo, NY 14260

Ted Kirschner
Foster Miller, Inc.
350 Second Ave.
Waltham, MA 02154-1196

Javaid Laghari
University of Buffalo
Bonner Hall, Room 316
Buffalo, NY 14260

Joe Landers
NASA Marshall Space Flight Center
MS CP 21
Huntsville, AL 35812

Jimmy Lee
NASA Marshall Space Flight Center
MS EE 81
Huntsville, AL 35812

Stan Levin
Allied-Apical
26396 Lombardi Road
Mission Viejo, CA 92692

Larry Linley
NASA White Sands Test Facility
P.O. Drawer MM
Las Cruces, NM 88004

Roger Lorelle
Aerospace Business Association
3040 Presidential Drive, Suite 201
Fairborn, OH 45324

Lyon Mandelcom
Westinghouse Electric Corp.
1310 Beulah Road
Pittsburgh, PA 15235

L. David Massie
WPAFB
WL/POOC
Wright Patterson AFB, OH 45433

Tamara S. McIntyre
NASA Marshall Space Flight Center
MS EH 02
Huntsville, AL 35812

Billy J. McPeak
NASA Marshall Space Flight Center
MS EB 13
Huntsville, AL 35812

Daniel Mulville
NASA Headquarters
Code QW
Washington, DC 20546

Patrick Murray
Naval Air Systems Command
1421 Jefferson Davis Hwy.
Arlington, VA 22243-4100

Ira Myers
NASA Lewis Research Center
MS 301-3
21000 Brookpark Rd.
Cleveland, OH 44135

John Nairus
WPAFB
WL/POOL
Wright Patterson AFB, OH 45433

Masao Oka
Allied-Apical
11 Columbia Rd.
P.O. Box 2332R
Morristown, NJ 07962

Eric Overton
NASA Lewis Research Center
MS 301-2
21000 Brookpark Rd.
Cleveland, OH 44135

Michael D. Pedley
NASA Johnson Space Center
Mail Code ES 53
Houston, TX 77058

R.V. Peterson
Rockwell International
Mail Code FB 86
P.O. Box 7009
Downey, CA 90241

Joe Piché
Foster Miller
195 Bear Hill Road
Waltham, MA 02154

Bruce Pike
Engineering Teledyne Thermatics
P.O. Box 909
Elm City, NC 27822-0909

Jeannette Plante
Unisys - NPPO
4700 Boston Way
Lanham, MD 20706-4311

John Reagan
NASA Lewis Research Center
MS 501-4
21000 Brookpark Rd.
Cleveland, OH 44135

Gerald Reuter
NASA Johnson Space Center
Mail Code VG 3
2101 NASA Road One
Houston, TX 77058

C.R. Sawyer
Boeing Aerospace
P.O. Box 240002
JR-10
Huntsville, AL 35824-6402

Greg Schmitz
NASA Lewis Research Center
MS 501-102
21000 Brookpark Rd.
Cleveland, OH 44135

Gene Schwarze
NASA Lewis Research Center
MS 301-2
21000 Brookpark Rd.
Cleveland, OH 44135

George Slenski
WPAFB
WL/MLSA
Wright Patterson AFB, OH 45433

Ron Solomon
McDonnell Aircraft Co.
Dept. 354
Mail Code 0341240
P.O. Box 516
St. Louis, MO 63166

Tom Stueber
Sverdrup Technology, Inc.
NASA Lewis Research Center
Group
MS 302-1
21000 Brookpark Rd.
Cleveland, OH 44135

Gale Sundberg
NASA Lewis Research Center
MS 301-2
21000 Brookpark Rd.
Cleveland, OH 44135

Jayant Suthar
University of Buffalo
312 W. Bonner Hall
Buffalo, NY 14260

REPORT DOCUMENTATION PAGE

Form Approved
OMB No. 0704-0188

Public reporting burden for this collection of information is estimated to average 1 hour per response, including the time for reviewing instructions, searching existing data sources, gathering and maintaining the data needed, and completing and reviewing the collection of information. Send comments regarding this burden estimate or any other aspect of this collection of information, including suggestions for reducing this burden, to Washington Headquarters Services, Directorate for Information Operations and Reports, 1215 Jefferson Davis Highway, Suite 1204, Arlington, VA 22202-4302, and to the Office of Management and Budget, Paperwork Reduction Project (0704-0188), Washington, DC 20503.

1. AGENCY USE ONLY (Leave blank)		2. REPORT DATE September 1994	3. REPORT TYPE AND DATES COVERED Conference Publication	
4. TITLE AND SUBTITLE First NASA Workshop on Wiring for Space Applications			5. FUNDING NUMBERS WU-323-15-03	
6. AUTHOR(S) Ahmad Hammoud and Mark W. Stavnes, compilers				
7. PERFORMING ORGANIZATION NAME(S) AND ADDRESS(ES) National Aeronautics and Space Administration Lewis Research Center Cleveland, Ohio 44135-3191			8. PERFORMING ORGANIZATION REPORT NUMBER E-9021	
9. SPONSORING/MONITORING AGENCY NAME(S) AND ADDRESS(ES) National Aeronautics and Space Administration Washington, D.C. 20546-0001			10. SPONSORING/MONITORING AGENCY REPORT NUMBER NASA CP-10145	
11. SUPPLEMENTARY NOTES Proceedings (viewgraphs only) of a workshop cosponsored by NASA Headquarters, Office of Safety and Mission Quality, and NASA Lewis Research Center, Cleveland, Ohio, July 23-24, 1991. Compiled by Ahmad Hammoud and Mark Stavnes, NYMA, Inc. 2001 Aerospace Parkway, Brook Park, Ohio 44142 (work funded by NASA contract NAS3-27186). Responsible person, Ahmad Hammoud, organization code 5430, (216) 433-8511.				
12a. DISTRIBUTION/AVAILABILITY STATEMENT Unclassified - Unlimited Subject Category 20			12b. DISTRIBUTION CODE	
13. ABSTRACT (Maximum 200 words) This document contains the proceedings of the First NASA Workshop on Wiring for Space Applications held at NASA Lewis Research Center in Cleveland, Ohio, July 23-24, 1991. The workshop was sponsored by NASA Headquarters Code QE Office of Safety and Mission Quality, Technical Standards Division and hosted by the NASA Lewis Research Center, Power Technology Division, Electrical Components and Systems Branch. The workshop addressed key technology issues in the field of electrical power wiring for space applications. Speakers from government, industry and academia presented and discussed topics on arc tracking phenomena, wiring applications and requirements, and new candidate insulation materials and constructions. Presentation materials provided by the various speakers are included in this document.				
14. SUBJECT TERMS Space power; Wiring; Insulation; Dielectrics; Arc tracking			15. NUMBER OF PAGES 180	
			16. PRICE CODE A09	
17. SECURITY CLASSIFICATION OF REPORT Unclassified	18. SECURITY CLASSIFICATION OF THIS PAGE Unclassified	19. SECURITY CLASSIFICATION OF ABSTRACT Unclassified	20. LIMITATION OF ABSTRACT	

EMD DATE JAN 4 1995